

## JPS10N-XXXX-333mV SERIES

Designed for quick and easy installation, JPS series of split core current transformer support both Power Quality measuring and Revenue Grade metering. Ideal for use in either new construction or retrofits, the split core design allows JPS Series CT to be opened and placed around the power cable, securely locked noticed by A SINGLE CLICK SOUND, thus speeding up installation time. Enhanced durability prevents effect of vibration or shock, considering characteristics of opening/closing hinges. Therefore, the JPS series current transformers can measure the current flowing through the line with Revenue grade accuracy. Unique design listed under UL 2808, UL/EN 61010-1 allows for field installation of JPS series in manufactured subpanels and electrical cabinets while maintaining the UL rating and manufacturer warranty.

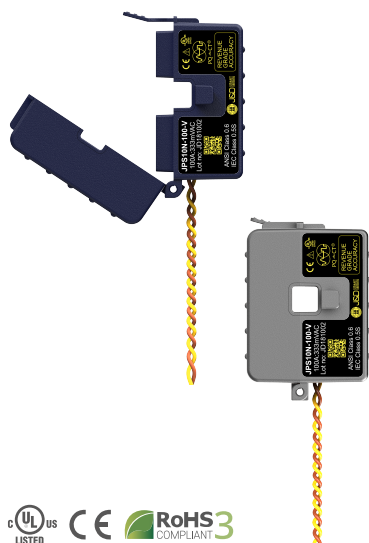

### Advantages

- IEEE/ANSI C57.13, Class 0.3/0.6 accuracy
- IEC 61869-2 Class 0.2S/0.5S accuracy
- Accessories options for installation (Terminal, plug-in, RJ12 port)

### Application

- ANSI C12.20 of class 0.5
- IEC 62053-22 of class 0.5S
- IEC 61000-4-30 A ED3 for Power Quality Meter

### Standards

- UL Listed UL2808 (XOBA) : Pollution Degree: 3 CAT IV, 600 Vac
- UL/EN61010-1(PICQ) : Pollution Degree: 3 CAT IV, 600 Vac



### Link

Model	Rated Amps	Output	Accuracy	Internal Burden (Ohms)
JPS10N-005-333mV	5A	333mV	0.5%	268.14Ω
JPS10N-015-333mV	15A	333mV	0.5%	89.27Ω
JPS10N-020-333mV	20A	333mV	0.5%	66.63Ω
JPS10N-030-333mV	30A	333mV	0.5%	44.74Ω
JPS10N-050-333mV	50A	333mV	0.5%	26.77Ω
JPS10N-070-333mV	70A	333mV	0.5%	19.07Ω
JPS10N-100-333mV	100A	333mV	0.5%	13.39Ω

Note: the burden resistor is built into the JPS10N-333mV SERIES.

### How to Use

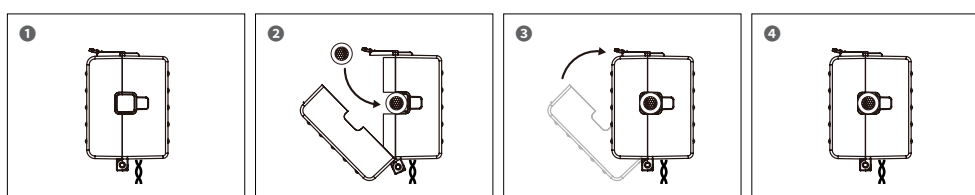

Please refer to "Split-core Current Transformer Installation Guide" for further details.

## 1. Specifications

- Accuracy : Class 0.5S
- System Voltage : 720 V (0.72 kV)
- Overload Withstand : 1.2 times rated current continuously
- Compliant with : IEC/EN 61869-2 & IEEE/ANSI C57.13
- Operating Temperature Range : -40°C to 70°C
- Relative Humidity : 0 to 90% non-condensing
- Test Voltage : 3 kV for 1 minute
- Frequency Range : 50/60 Hz
- Protection Level : 3.0V0-P
- Insulation Category : CAT III 1000 Vac, CAT IV 600 Vac
- Output Lead Wires :  
 Style : Two conductor, brown and yellow twisted pair (equivalent to about one #8 AWG 0.213" dia.), MTW, UL 1015  
 Standard length : 8 ft (2.44m)  
 Gauge : #18 AWG  
 Voltage : 600Vac

### 1.1 Accuracy

- Ratio Error :  
 Accuracy 0.5% conforms to IEC 61869-2 & IEEE/ANSI C57.13 meets the measuring range from 1% to 120% of  $I_n$
- Phase Angle :  
 50/60 Hz – 0.0 to 2.0 degrees leading from 1% to 120% of rated current

### Position Sensitivity

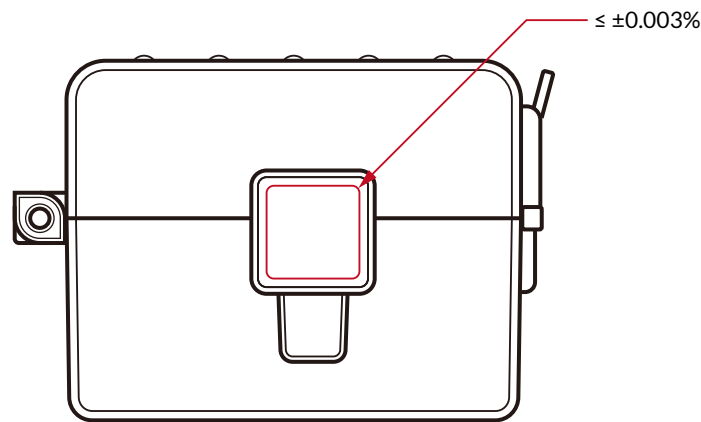

### Shock and Air Gap Test

#### ▪ Shock and Vibration Test Report(JPS10)

100A	
Phase error(°)	Linearity Error(%)
0.21	-0.15
0.23	-0.16



100A	
Phase error(°)	Linearity Error(%)
0.21	-0.17
0.22	-0.18

#### ▪ Core Air Gap Test Report(JPS10)

100A	
Air gap : 2microns	
Phase error(°)	Linearity Error(%)
0.21	-0.15



100A	
Air gap : 2.5microns	
Phase error(°)	Linearity Error(%)
0.21	-0.17

### Harmonic Graphs

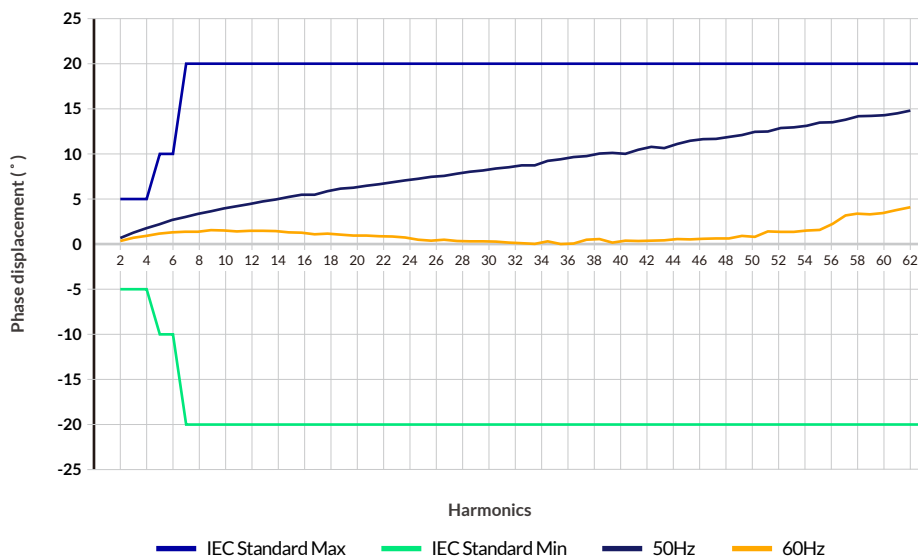
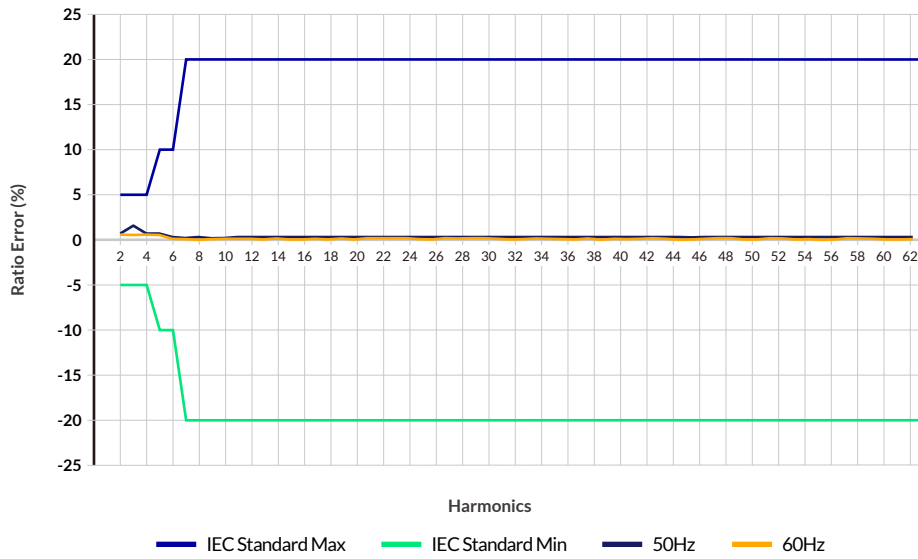

### 1.2 Regulatory

- CE
- UL Listed UL2808 (XOBA) : Pollution Degree: 3 CAT IV, 600 Vac
- UL/EN61010-1(PICQ) : Pollution Degree: 3 CAT IV, 600 Vac
- RoHs Compliant

### 1.3 Environmental

- **Operating Temperature** : -40°C to 70°C (-40°F to +158°F)
- **Operating Humidity** : Non-condensing, 0 to 95% relative humidity(RH)
- **Operating Altitude** : Up to 3000 m (9842 feet)
- **Pollution Degree** : 3 (harsh environment)
- **Indoor Use** : Suitable for indoor use
- **Outdoor Use** : Suitable for outdoor use when mounted in a NEMA 3R or 4 (IP 66) rated enclosure, provided the ambient temperature will not exceed 55°C (131°F)

### 1.4 Mechanical

- Width : 61mm
- Height : 48mm
- Thickness : 35mm
- Opening : 10mm
- Weight : 230g
- Core Nickel Core : high permeability ferrite
- Standard lead wire : 2.44m, 18AWG

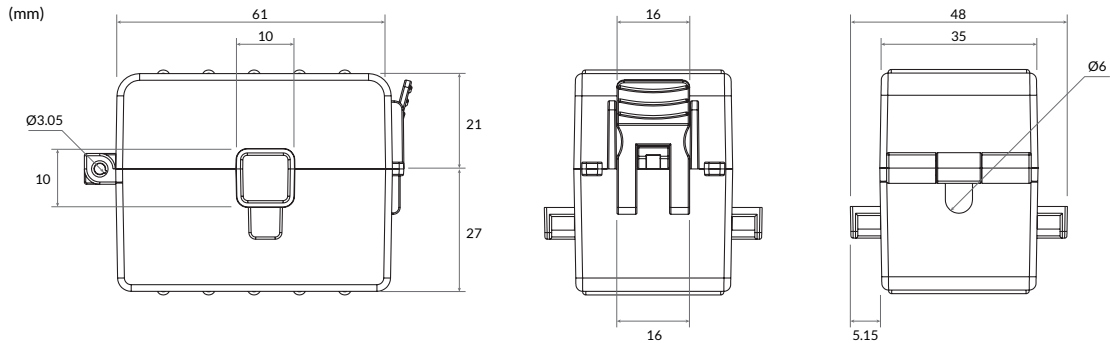

### 1.5 Labels

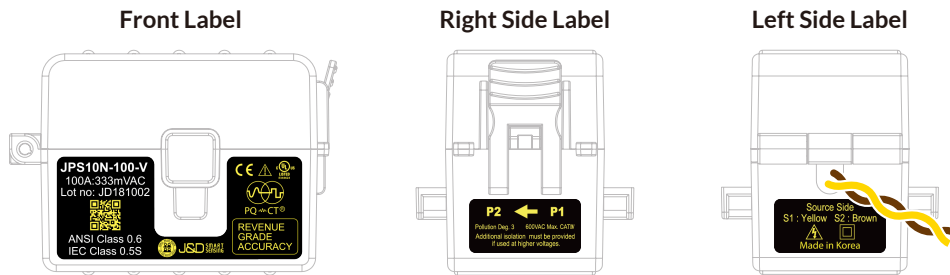

- QR code : <Model> ; <SerialNum> ; Scan QR code for Instruction Manual
- Orientation : Mount the CT referring to the right side label attached(P1->P2).

## 2. Typical Accuracy

- In the following graphs, a positive phase angle error indicates that the output of the CT leads the primary current.
- Graphs show typical performance at 25°C, 60 Hz
- Performance Graphs - The standard CT meets ANSI/IEEE C57.13 class 0.6 standard & IEC 61869-2 standard class 0.5

### 2.1 Schematic Diagram

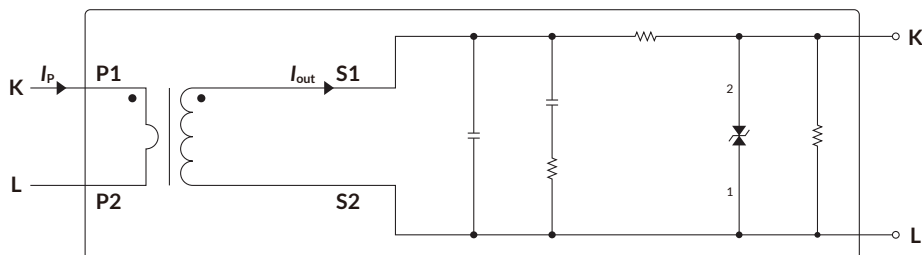

2.2 JPS10N-005-333mV

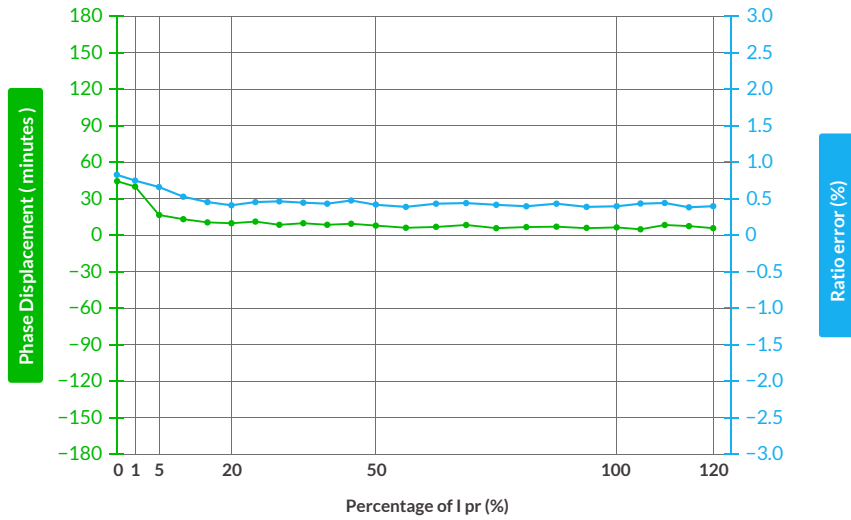

2.3 JPS10N-015-333mV

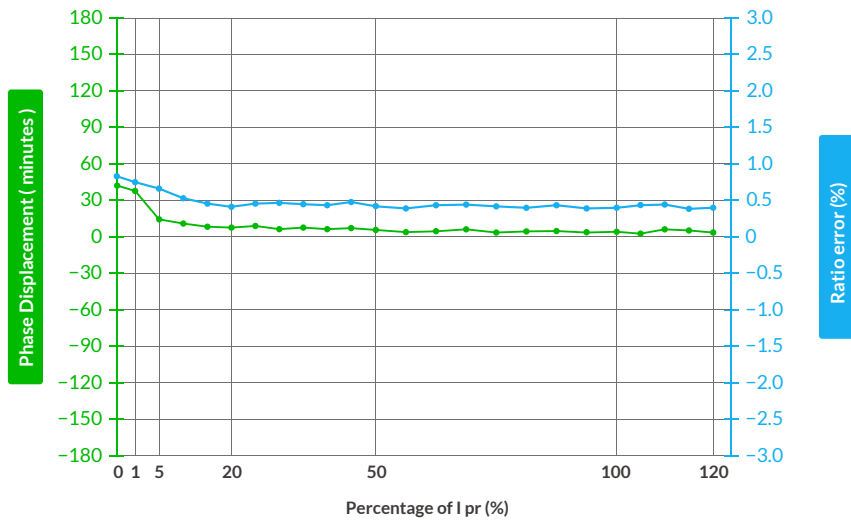

2.4 JPS10N-020-333mV

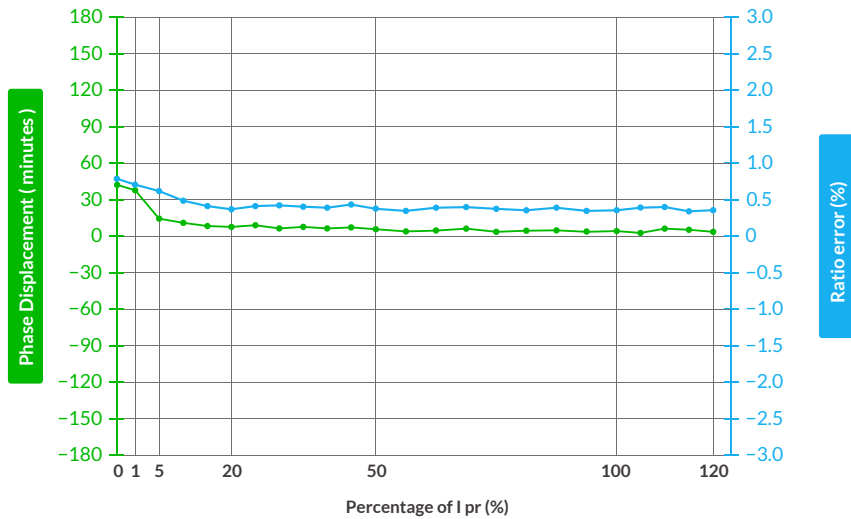

2.5 JPS10N-030-333mV

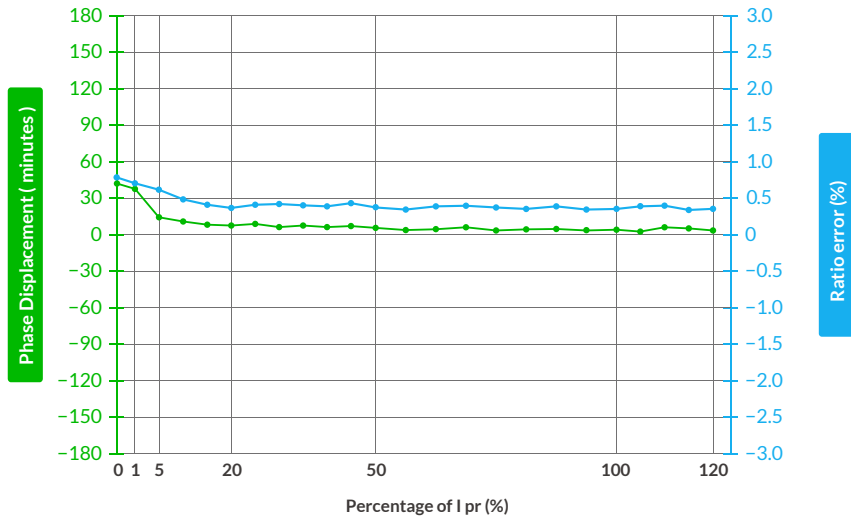

2.6 JPS10N-050-333mV

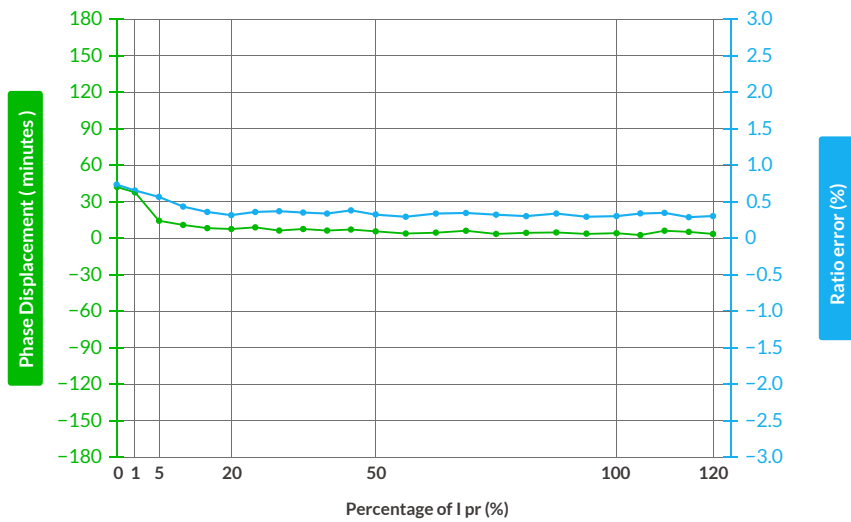

2.7 JPS10N-070-333mV

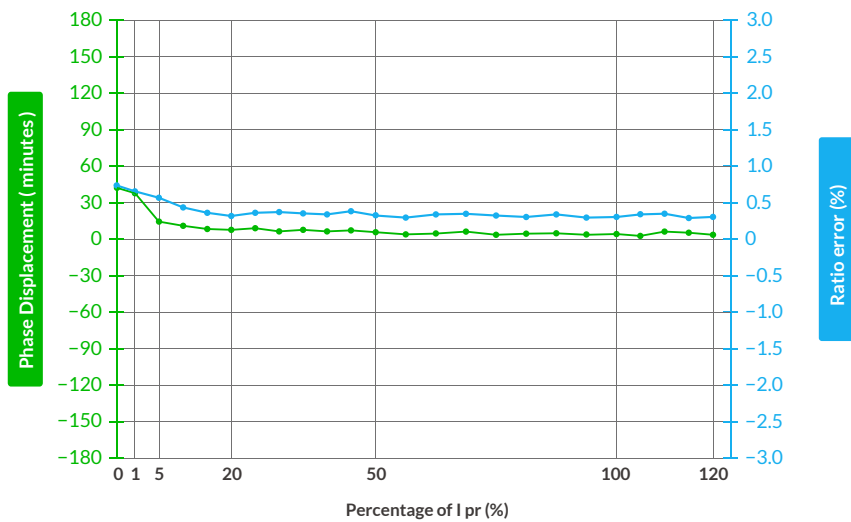

2.8 JPS10N-100-333mV

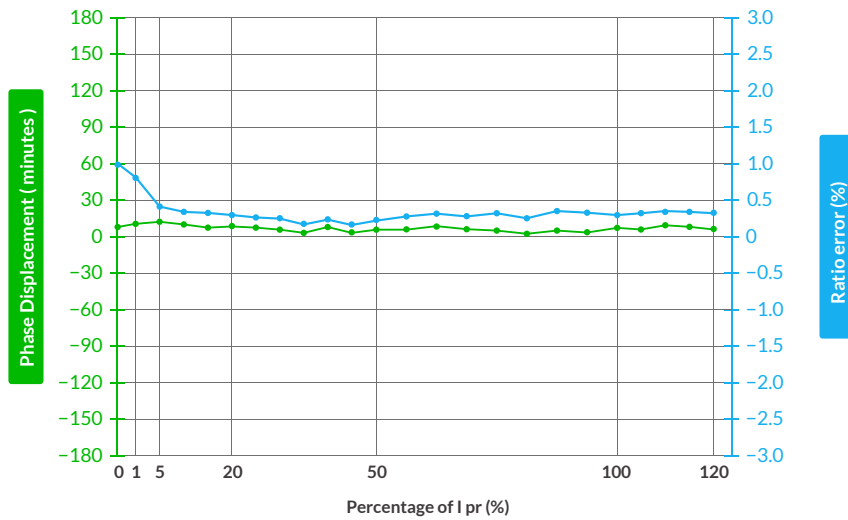

3. Safety

The J&D CTs are UL2808 Listed, UL/EN 61010-1, CE, RoHS compliant and certified, are also conformed up to Pollution degree 3, 600Vac CAT IV rated devices.



Please be sure that Failure to follow these instructions can result in serious injury and/or cause damage.

The transducer shall be used in electric/electronic equipment in accordance with the operating instructions of all related systems and component manufacturers with respect to applicable standards and safety requirements.

Follow corresponding national regulations and safe electrical work practices.

This equipment must only be installed and serviced by qualified personnel. And the qualified personnel is one who has skills and knowledge related to the construction and operation of this electrical equipment and installations, and has received safety training to recognize and avoid the hazards involved.



When operating the transducer, there may be dangerous active voltages (e.g. primary conductor) in certain parts of the module. Users should make sure to take all necessary steps to protect against electric shock. The transducer is a built-in device containing conductive parts that are inaccessible after installation. Therefore, a protective enclosure or additional insulation barrier is necessary.

Safe and trouble-free operation of this converter can only be guaranteed if transport, storage and installation are carried out correctly and operation and maintenance are carried out carefully.

4. Remark

- $V_o$  is positive when  $I_p$  flows in the direction of the arrow. (o : output, p : primary current)
- Temperature of the primary conductor should not exceed 80°C(176°F).
- Dynamic performances (di/dt and delay time) are the best with a single bar when the primary hole is completely filled.

5. Attention

Contact areas (air gap) must be kept clean (particle free) to ensure proper performance.