

SPLIT-CORE CURRENT TRANSFORMER

JM21NA-XXX-VH



Split-core current transducer for the electronic measurement of AC waveform currents, with galvanic isolation between the primary circuit (power) and the secondary circuit(measurement). 0-5V DC, 0-10V DC, 4-20mA DC output proportional to the RMS value of the primary current.

MAIN CHARACTERISTICS

- Current transformer and RMS circuit in a single case
- Choice of primary current ranges: 5 to 250A RMS
- Choice of standard output types: 4-20mA, 0-5V
- Accuracy: <2% of nominal primary current
- Bandwidth: 50/60 Hz

ADVANTAGES

- High isolation between primary and secondary circuits
- Compact case
- Cost-effective solution
- Easy installation

FEATURES

- True-RMS (Bipolar DC in => Unipolar DC out)
- Active 0-5V DC output or
- Active 4-20mA output (no loop feeding!)
- Single power supply (24V)
- Operating range: -20°C to +60°C
- Isolation test voltage : 3.5kV RMS / 50Hz / 1min
- Sensing aperture : 21mm
- UL94-V0 recognized materials

APPLICATIONS

- Automation and Supervision
- Safety and Condition Monitoring
- HVAC & Pumps
- Refrigeration
- Small Industrial Motors
- Fans
- Lighting



SPECIFICATION

Rated Current (A)	5, 10, 20, 25, 50, 75, 100, 150, 200, 250	
Model	Output	Electrical Data
JM21NA-XXX-VH	0-10V DC	Output Impedance 23kΩ(Self Power) & Average output

HOW TO USE

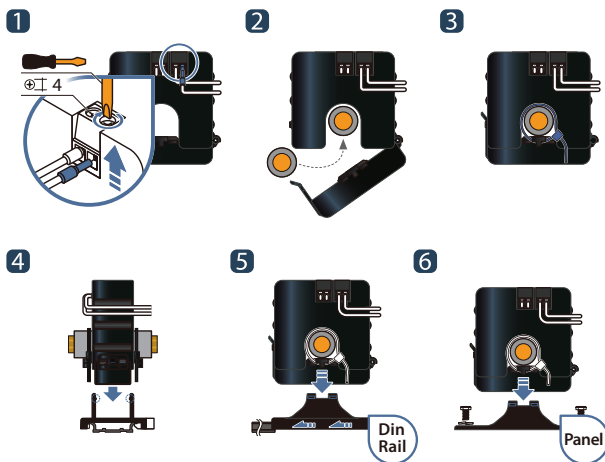

DIMENSIONS

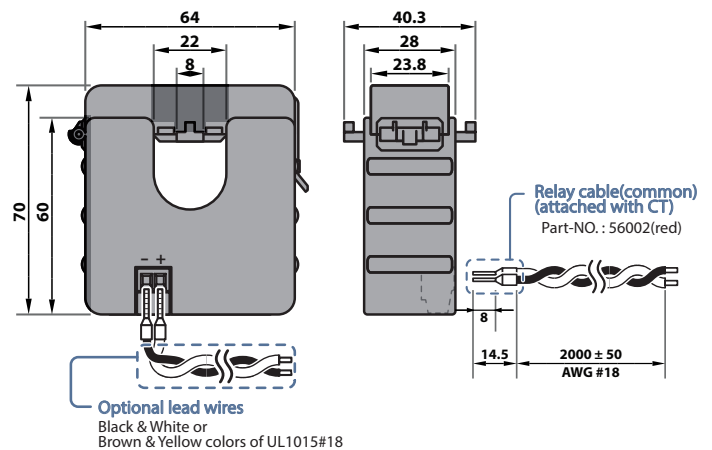

ACCESSORY OPTION

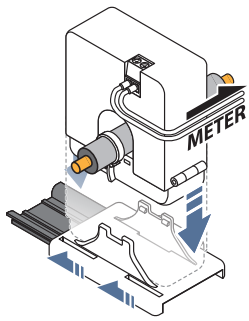

DIN RAIL MOUNTING

Mount the bracket on the rail and install current transformer

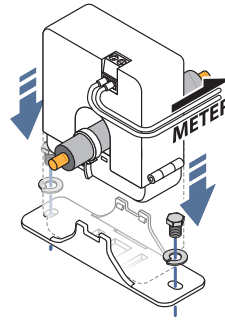
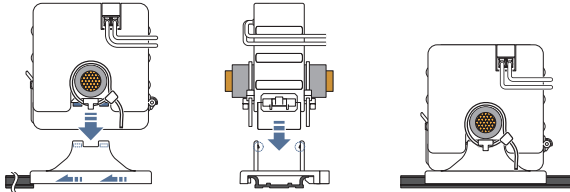
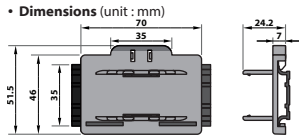

PANEL MOUNTING

Tighten screws on the hole to mount bracket and install current transformer

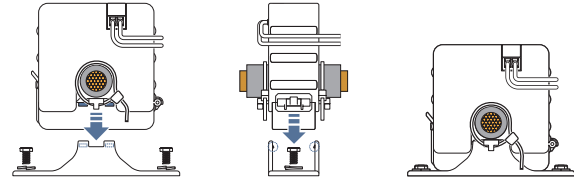
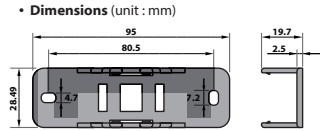

INTERNAL CIRCUIT DRAWING

• JM21XA-XXX-RMS

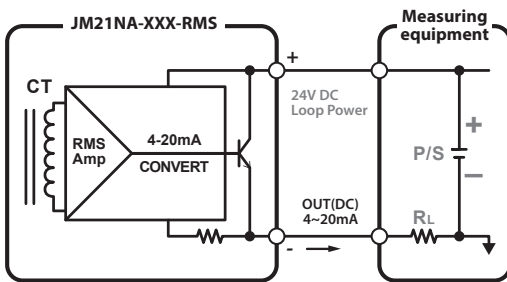

2-Wire Transmission method (Loop powered) using P/S(+ side) of Measuring equipment

APPLICATIONS

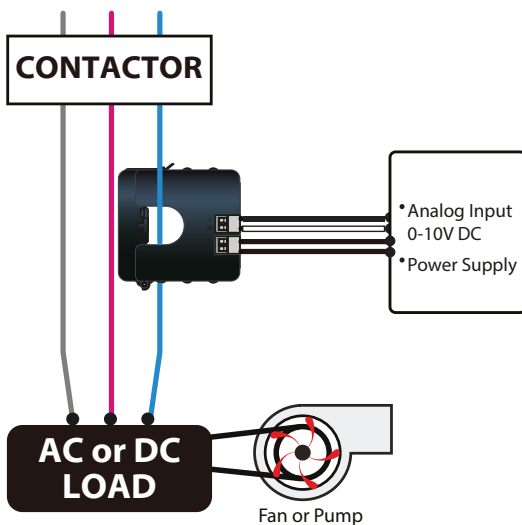

CAUTION: DANGER

HAZARD OF ELECTRIC SHOCK, EXPLOSION, OR ARC FLASH

- In order to guarantee safe operation of the transformer, please read and understand the instructions thoroughly. For your reference, see NFPA 70E in the USA, or applicable local codes.
- This equipment must only be installed and put into operation by qualified electrical personnel or appropriately trained individual.
- Before servicing the CTs, turn off all sources of power and use a properly rated voltage sensing device to check if the power is off.
- Current transformer secondary must be shorted or connected to a burden all times.
- The transformer (split core type) must not be operated when it is not fully closed or the installation is not completed.
- Rearrange all covers and protective devices before powering the equipment.

NOTICE

- This product is not intentionally made for safety applications.
- Make sure not to install this transformer in hazardous or classified areas.
- The installer is responsible for conformance to all applicable codes.
- Ignoring the warnings can lead to serious injury and/or cause damages.
- A qualified person is the one who is skilled and has knowledge about the construction and operation of this electrical equipment, and has received safety training to recognize and avoid the hazards involved. (NEC2011 Article 100)
- If this product is used in a way not specified by the manufacturer, the protection offered by the product may be impaired. No responsibility is taken by J&D Electronics for any consequences arising by not following this material properly