

Split-Core Current Transducer IDCS16I

IDCSXXI series is a split core current transformer for the electronic measurement of DC waveform current with galvanic separation between the primary current and the secondary output voltage.
 IDCSXXI series is an ideal CTid built-in split-core current transformer for JAGUAR IoT meters, and its accuracy is 1%.



Applications

- AC variable speed drives and servo motor drives
- Static converters for DC motor drives
- Battery supplied applications
- Uninterruptible Power Supplies (UPS)
- Switched Mode Power Supplies (SMPS)
- Power supplies for welding applications.

Advantages

- Low temperature drift
- Optimized response time
- Wide frequency bandwidth
- No insertion losses
- High immunity to external interference
- Current overload capability.
- Excellent accuracy
- Very good linearity

Specification

SPEC	MODEL	IDCS16I	IDCS16I	IDCS16I	IDCS16I	IDCS16I	IDCS16I	IDCS16I	IDCS16I	IDCS16I
		-005	-010	-015	-020	-025	-030	-050	-075	-100
Rating Current		5A	10A	15A	20A	25A	30A	50A	75A	100A
Maximum Current		7.5A	15A	22.5A	30A	37.5A	45A	75A	112.5A	150A
Output Voltage	±471mV, 1% at rated current(F.S) RL=10KΩ									
Residual Voltage	Within ±20mV (no load)									
Noise Level	Less than 15 mVp-p(no load)									
Output Linearity	±1% rated current(F.S)									
Hysteresis (FS→0)	Within ±10mV									
Power Supply	DC +5V ±5% 40mA									
di/dt Response Time	2 μ sec (Typ.) at di/dt=F.S/μ sec									
Output voltage temperature coefficient	±0.08% / °C typ									
Residual voltage temperature coefficient	±0.095mV / °C									
Insulation Withstand Voltage	AC 1500V / 1min.									
Insulation Resistance	DC 500V / 500MΩ max									
Operating Condition	-25°C~+75°C, 85% RH non-condensing									
Storage Condition	-35°C~+90°C, 85% RH non-condensing									
Standard lead wire	400mm, 26AWG*4C									

Split-Core Current Transducer IDCS16I

Graphs

Output Voltage Characteristic

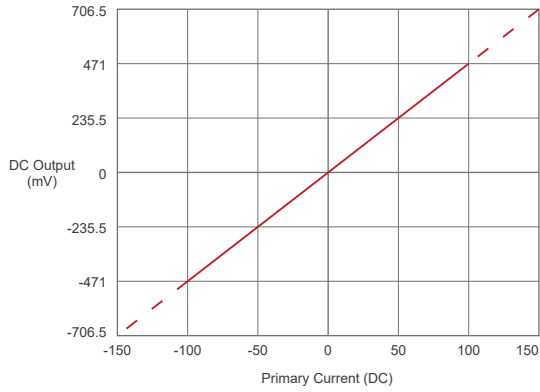

Frequency Characteristic

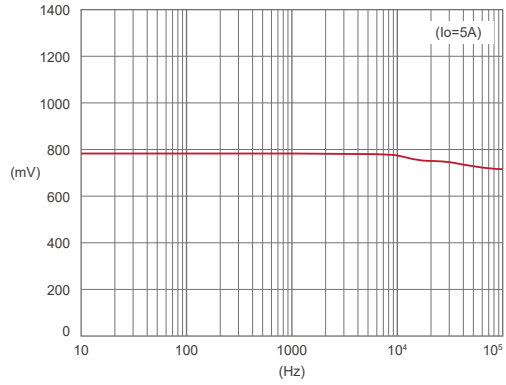

Output Wave-1

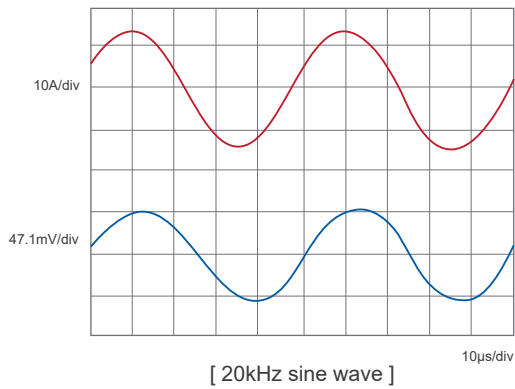

Output Wave-2

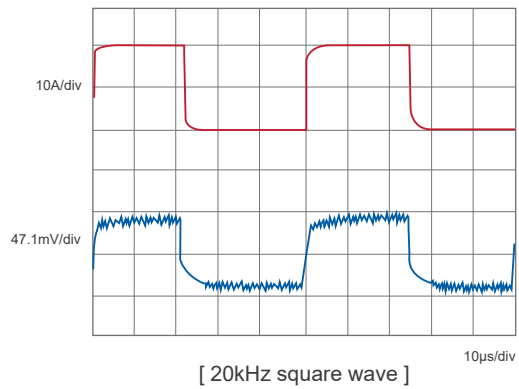

How to use

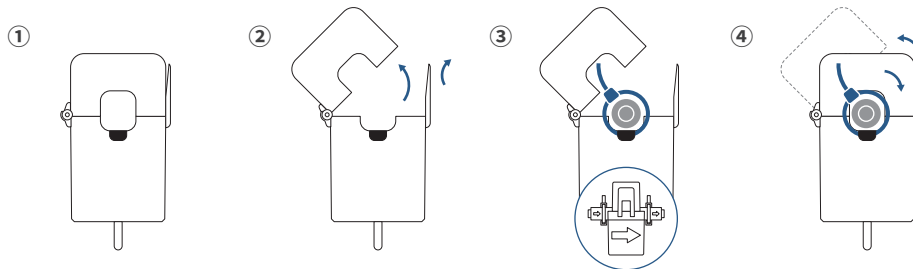

Split-Core Current Transducer IDCS16I

Dimensions IDCS16I

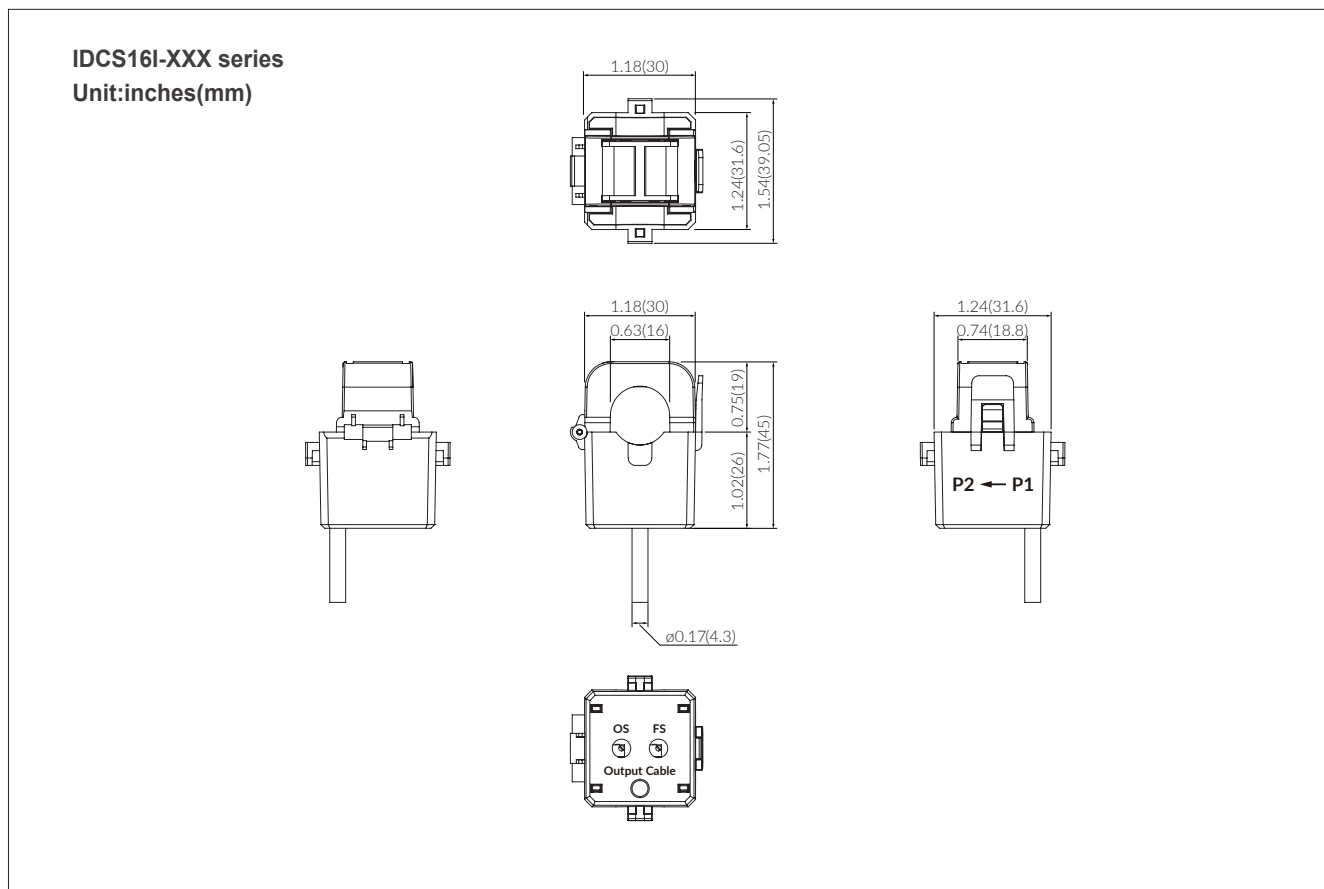

Connection Diagram

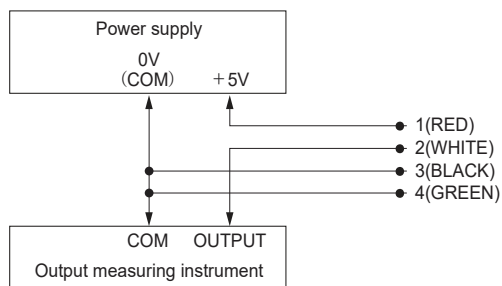
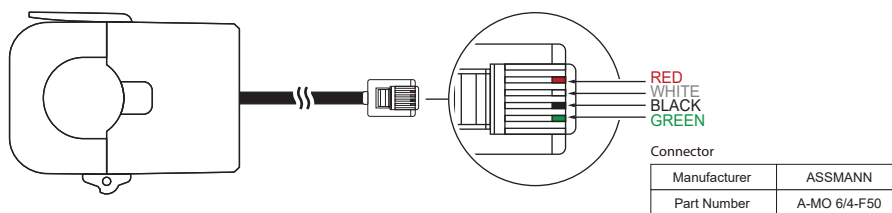

Terminal Pin	Function
1(RED)	+5 V
2(WHITE)	OUTPUT
3(BLACK)	GND(Power Supply)
4(GREEN)	OUTPUT GND

Split-Core Current Transducer IDCS16I

Powered Sensor Wiring Program

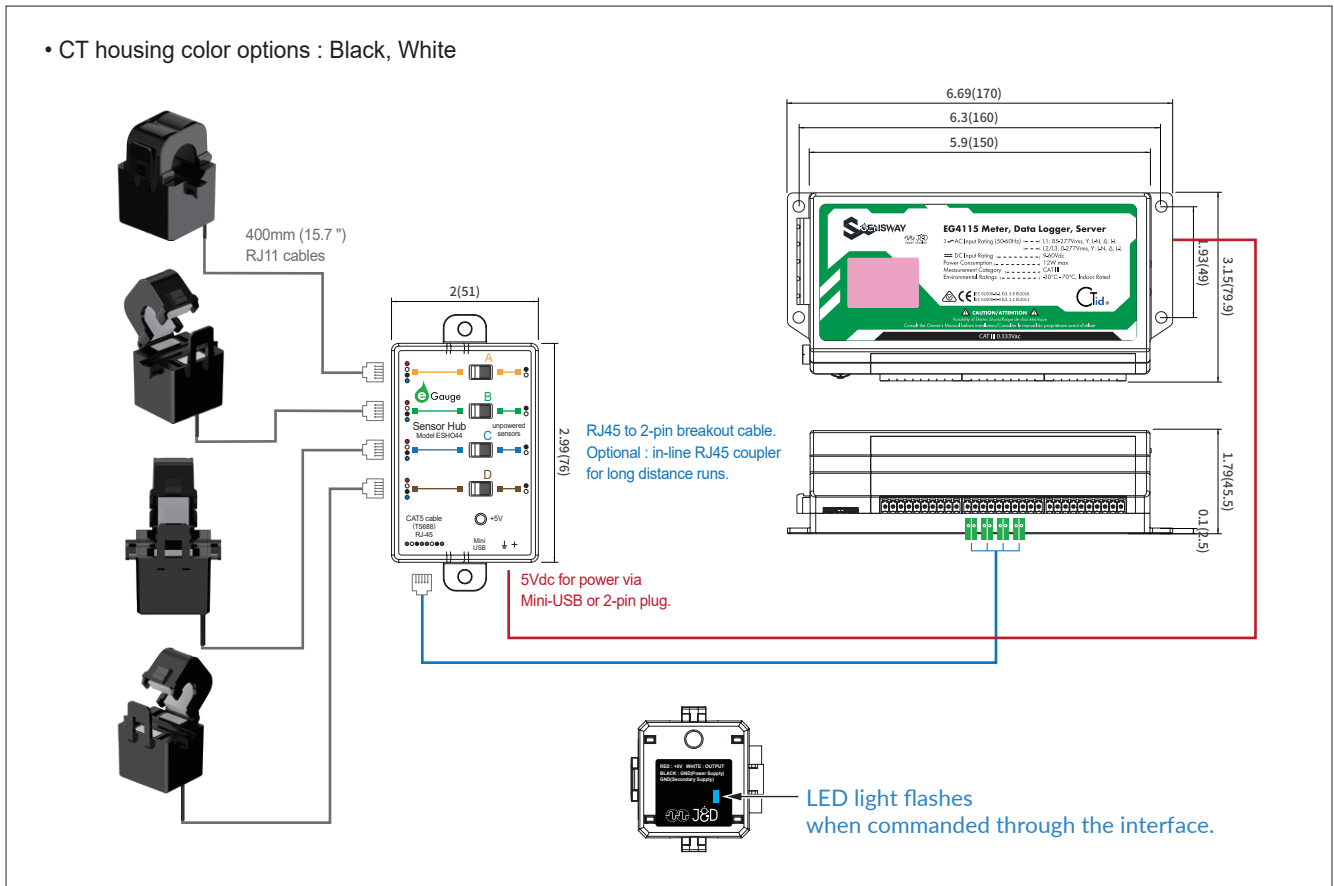

Safety

The J&D CTs are UL/EN 61010-1, CE, RoHS compliant and certified, are also conformed up to Pollution degree 2, 600Vac CAT III rated devices.



Please be sure that Failure to follow these instructions can result in serious injury and/or cause damage. The transducer shall be used in electric/electronic equipment in accordance with the operating instructions of all related systems and component manufacturers with respect to applicable standards and safety requirements.

Follow corresponding national regulations and safe electrical work practices.

This equipment must only be installed and serviced by qualified personnel. And the qualified personnel is one who has skills and knowledge related to the construction and operation of this electrical equipment and installations, and has received safety training to recognize and avoid the hazards involved.

In addition, the installation and maintenance shall be done with the main power supply disconnected except if there are no hazardous live parts in or in close proximity to the system and if the applicable national regulations are fully observed.



When operating the transducer, there may be dangerous active voltages (e.g. primary conductor) in certain parts of the module. Users should make sure to take all necessary steps to protect against electric shock. The transducer is a built-in device containing conductive parts that are inaccessible after installation.

Therefore, a protective enclosure or additional insulation barrier is necessary.

Safe and trouble-free operation of this converter can only be guaranteed if transport, storage and installation are carried out correctly and operation and maintenance are carried out carefully.

Split-Core Current Transducer IDCS16I

Remark

- V_o is positive when I_p flows in the direction of the arrow. (o : output, p : primary current)
- Temperature of the primary conductor should not exceed 75°C(167°F).
- Dynamic performances (di/dt and delay time) are the best with a single bar when the primary hole is completely filled.

Attention

Contact areas (air gap) must be kept clean (particle free) to ensure proper performance.
