

Siding Trim Bending Guide

Version 2

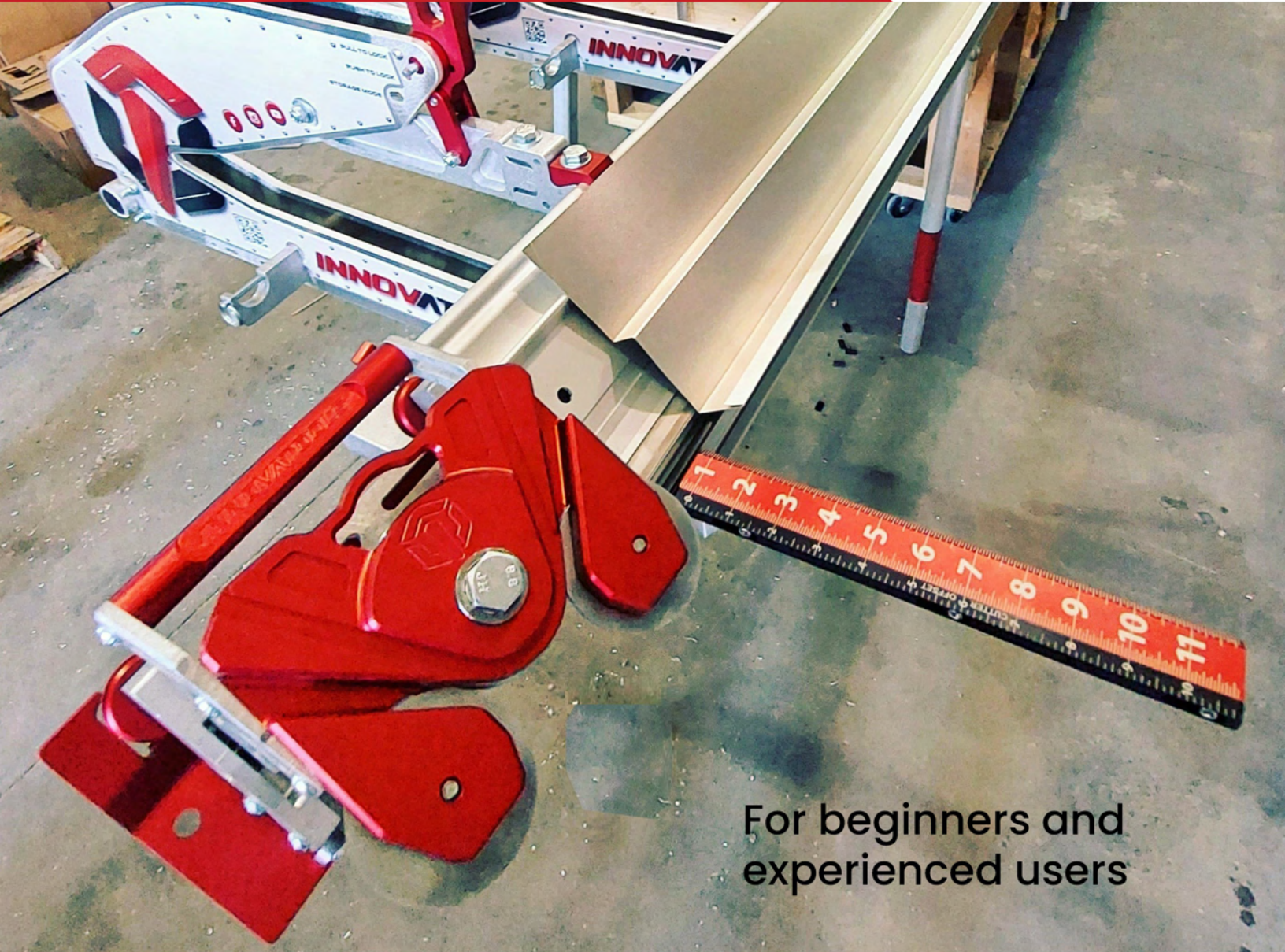

INNOVATOOLS



For beginners and
experienced users

HIGH
PERFORMANCE TOOLS
FOR CONTRACTORS BY CONTRACTORS



INNOVATOOLS

“

We are happy to share with you this latest project we are working on. We hope it helps fellow contractors become more efficient on the brake and help them improve their bending capabilities regardless of their experience.

We will be periodically adding more and more pages showcasing different bends or shapes and shape assemblies that can be created using a portable siding brake so make sure to keep subscribed to our newsletter to receive the latest updates.

The steps and methods shown in this guide will work on our Innovatools Modular brake but they also apply to Tapco or Van-Mark brakes the exact same way.

We hope this guide brings simplicity to the tool that is a siding brake that unfortunately seems to intimidate alot of new and experienced users.

”

Alex Cloutier
President/inventor
Direct: 613-978-2637
Email: alex@innovatools.ca

Reach out to me if you have other shapes you would like me to add to our flyer to further help others! Thank you to our thousands of customers using Innovatools products and techniques!



WATCH THE VIDEOS ON YOUTUBE



PURCHASE DIRECTLY FROM THE MANUFACTURER



EXPERIENCE THE INNOVATOOLS ADVANTAGE



TIME IS MONEY, TEST OUT HOW MUCH TIME OUR TOOLS WILL SAVE YOU



WORLDWIDE SHIPPING DAILY FROM INNOVATOOLS.CA



INNOVATOOLS.CA



How to follow this guide

Quick disclosure; This guide shows the way I personally proceed with bending different trim shapes. It is not the only way and it should only be used as a starting point. Always question how you do a certain task and always try and improve it to make it more efficient. If you come up with a new piece or a better/more efficient or accurate way of doing a certain piece, please reach out! I'll be happy to update it so that it can benefit everyone and i'll even mention you next to it to give you credit when credit is due!

Things to pay attention to when using the guide;

- Finished side orientation when material is inserted in the brake for a specific bend (facing up or facing down) is critical to the end piece, pay attention to it for each bend.

- Pay attention the red narrow triangle, it represents the location of the anvil/clamp/jaw. The black line creating the shape on the drawing represent what the piece will look like upon completion of the bend on that step. The narrow tip point on the red triangle represents the tip of the brake anvil/clamp/jaw. Imagine it as if you're always looking at the right side of your brake from the end with the front of the brake facing left.

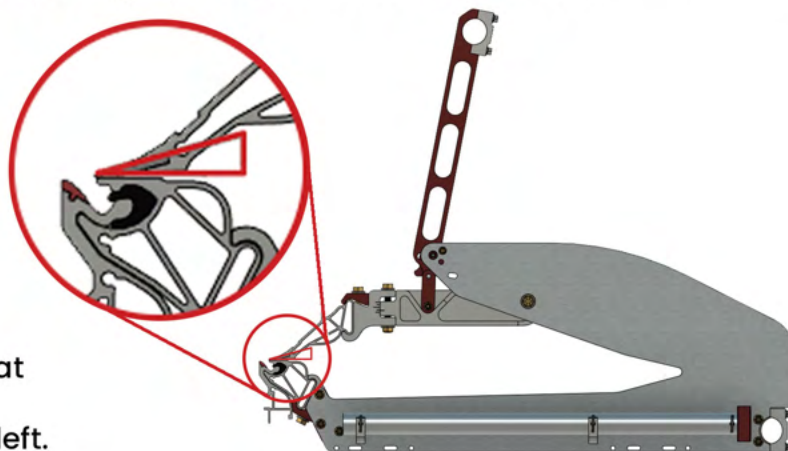

- Follow the bending angles as represented by the black line on the drawing. A 90degree bend on the line/drawing represents a 90degree bend on your brake. A full hem bend is represented by a line doing a 180degree bend where the material is folded onto itself.

Side note ; To create a hem bend (180degree bend)

- 1) Insert material with finished side facing correct way, line up at appropriate distance and lock brake brake anvil/clamp/jaw
- 2) Pivot the hinge the whole way
- 3) Open the brake anvil/clamp/jaw
- 4) Take the piece out
- 5) Close the brake anvil/clamp/jaw
- 6) Insert the tip of the 130degree bend resting it on the hinge pocket.
- 7) Pivot the hinge all the way up pinching/crimping the angle to close it from 130degree to 180 degree



How to: Crimp a Hem/Safety/Double Bend

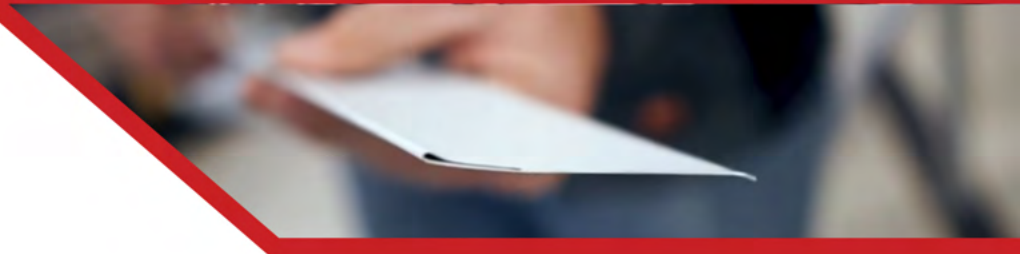

Finished side

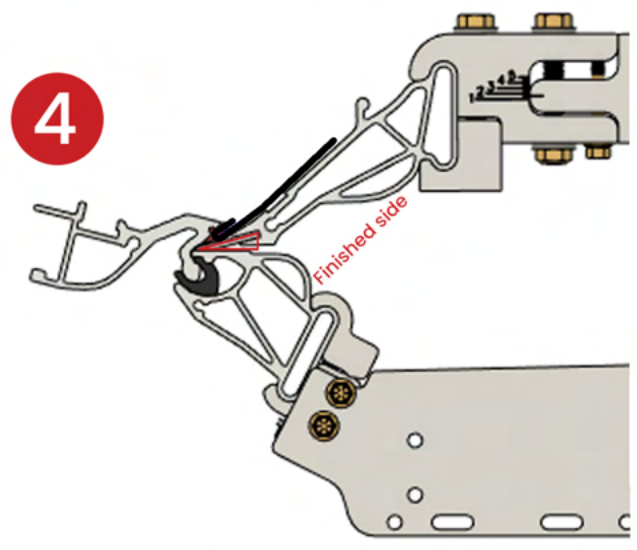
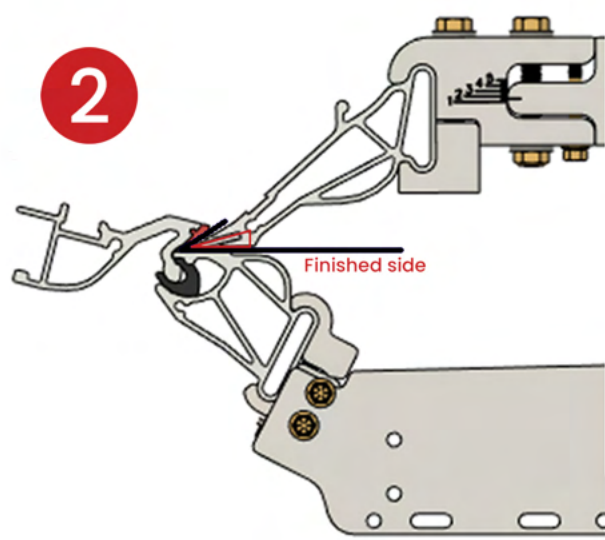
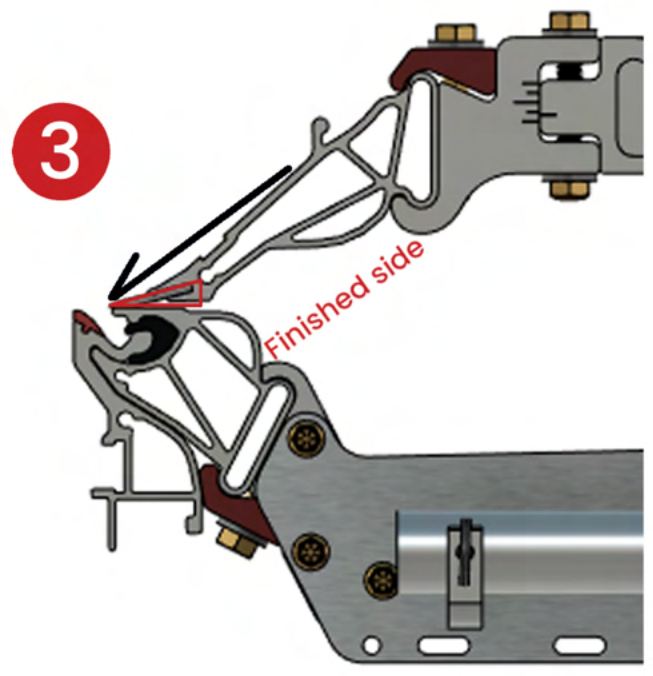
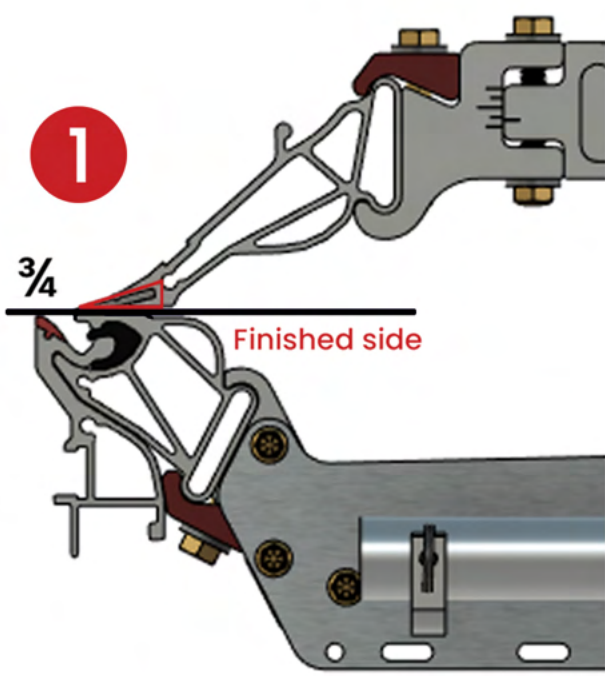

 = anvil/clamp location

Simple Fascia Trim



Starting Piece Width =
6" (2x4 fascia) or 8" (2x6 fascia)
* when tucked under roof drip edge



1



2



 = anvil/clamp location



Step Fascia Trim (2x6)

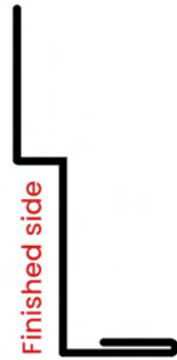

Starting Piece Width = 8" * when tucked under roof drip edge

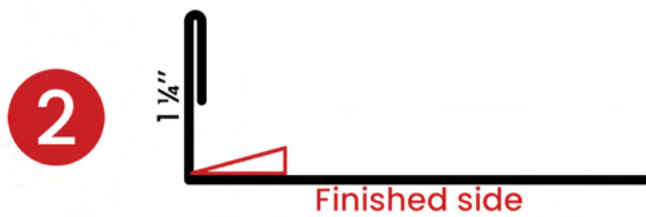
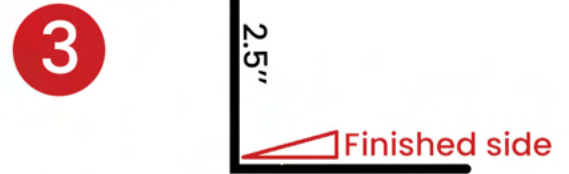

 = anvil/clamp location

Window Drip Edge

Finished side

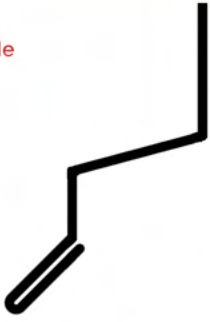

Starting Piece Width = 5.5"

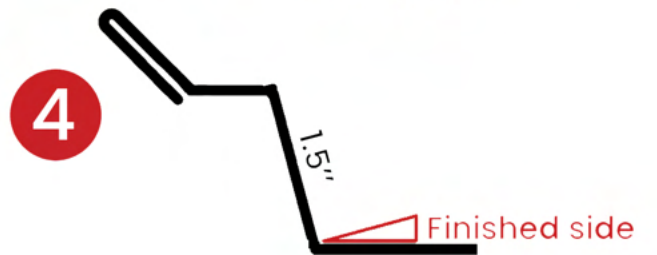
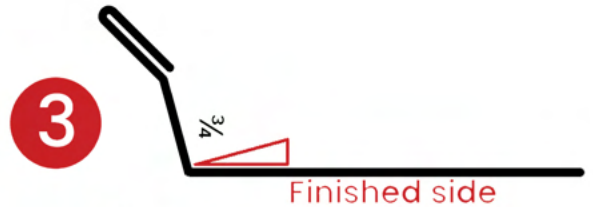

= anvil/clamp location



Roof Drip Edge

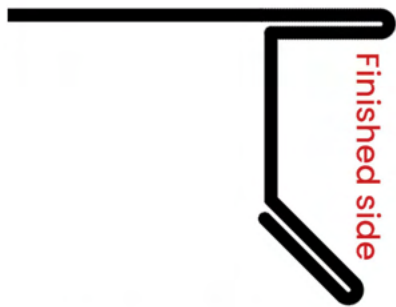

Starting Piece Width = 6"

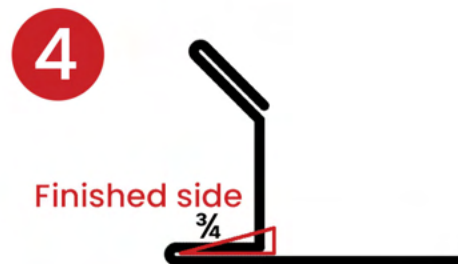
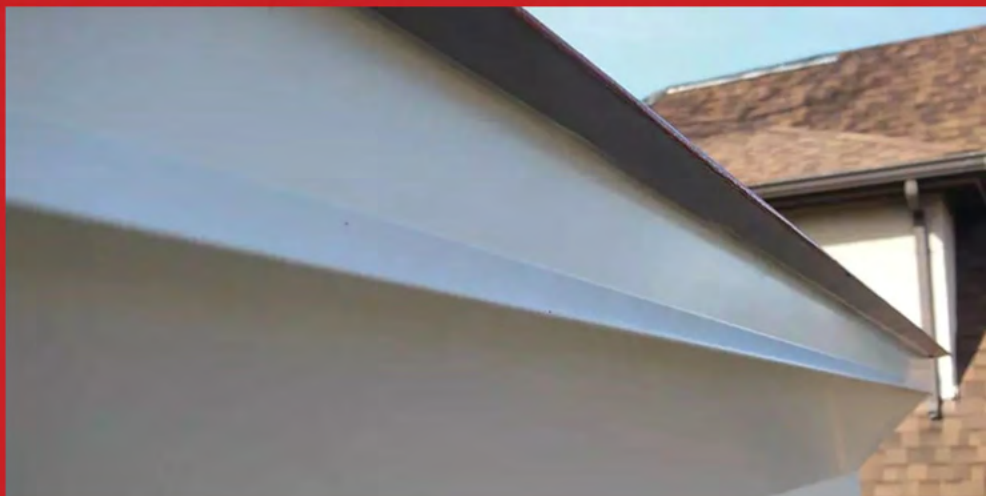

 = anvil/clamp location



Outside Corner Post with Built in J-Trims

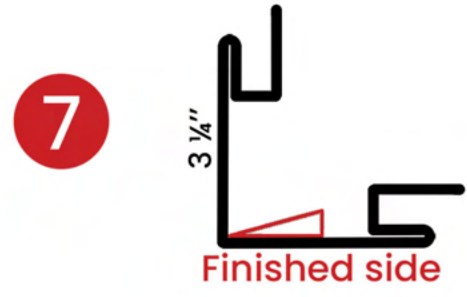
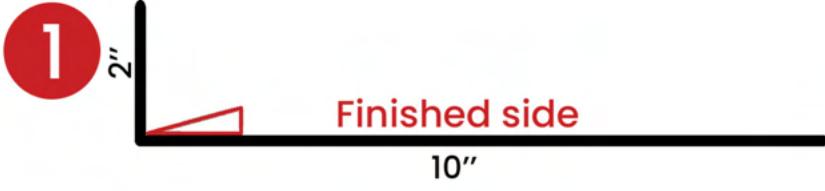
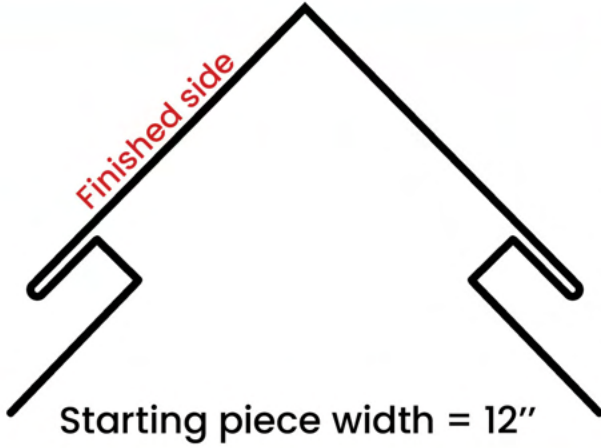

= anvil/clamp location

Inside Corner with Built-in J-trims

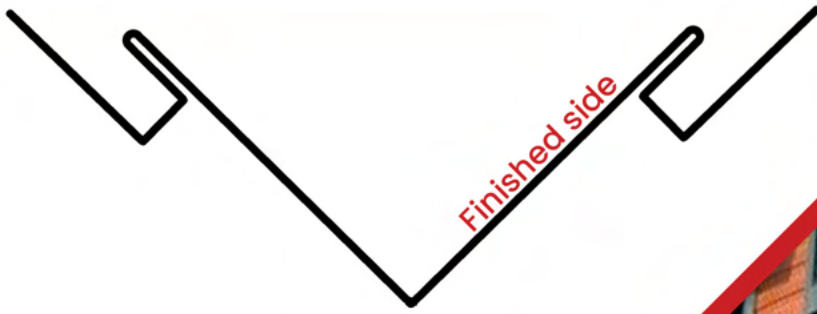

Starting piece width = 12"

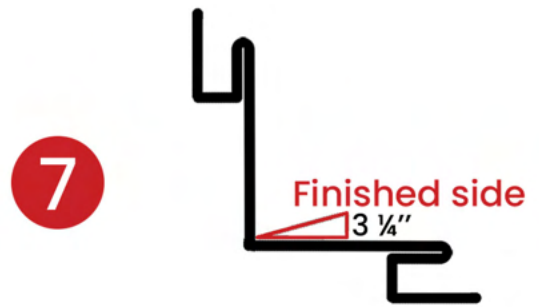
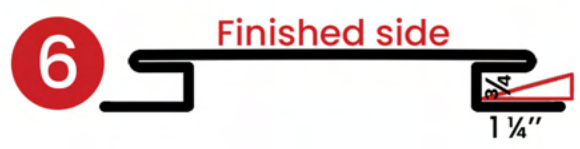

Window or Door casing with built-in J-trim

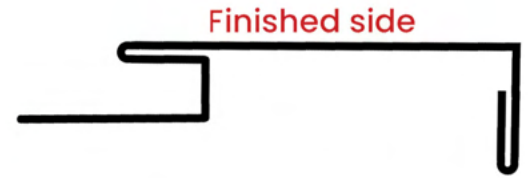

Starting Piece Width = 8"

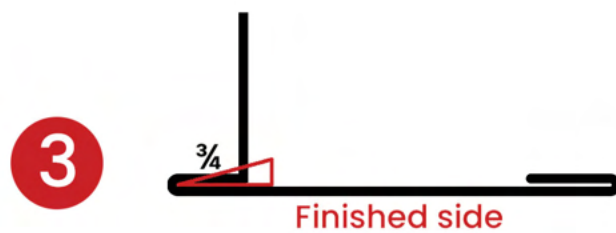
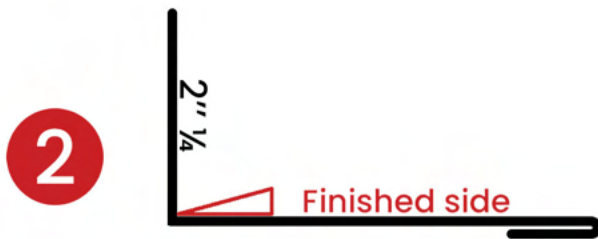

 = anvil/clamp location

F Channel Trim

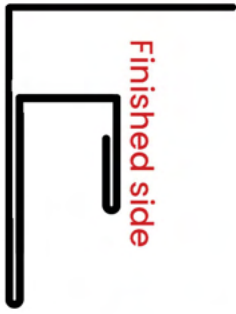

Starting Piece Width = 8"



1



2



3



4



5

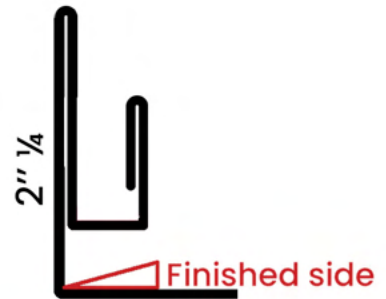

 = anvil/clamp location



Soffit Miter



Starting Piece Width = 7.5"

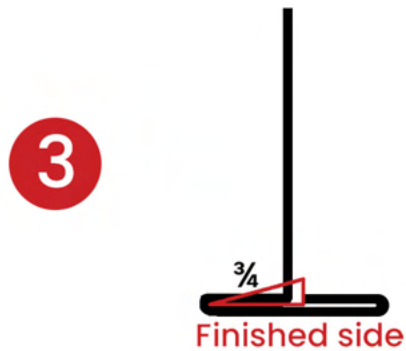
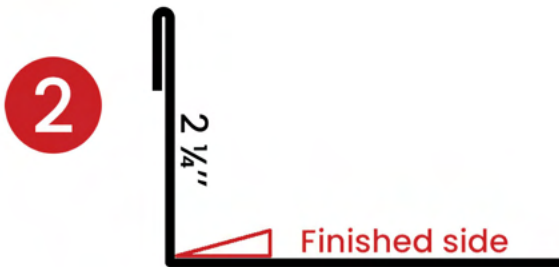

 = anvil/clamp location



Crown moulding with built in soffit and siding J-Trims

Part 1 of 2

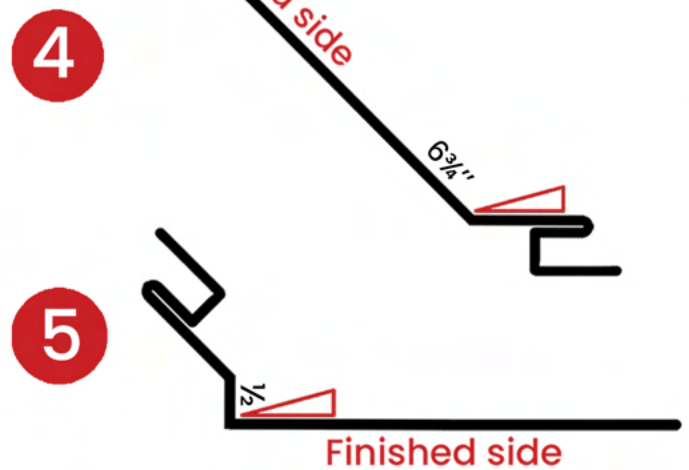
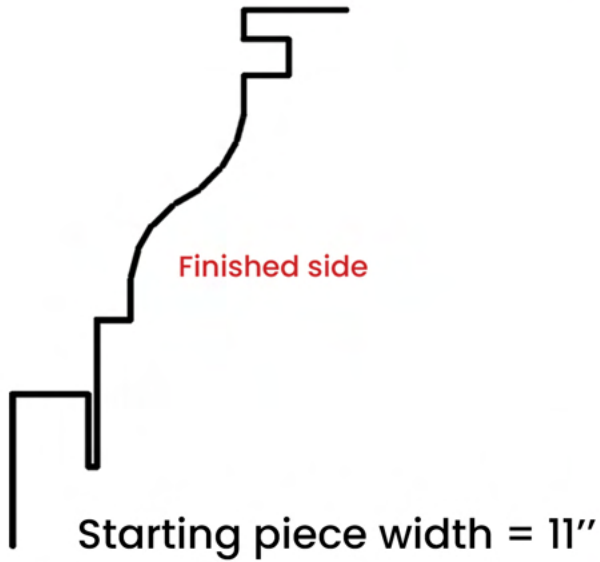

= anvil/clamp location

(PART 2 on next page)



INNOVATOOLS.ca



Crown moulding with built in soffit and siding J-Trims

Part 2 of 2

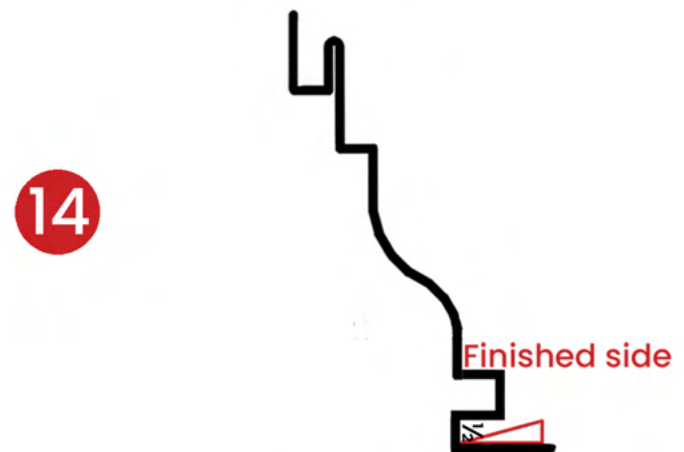
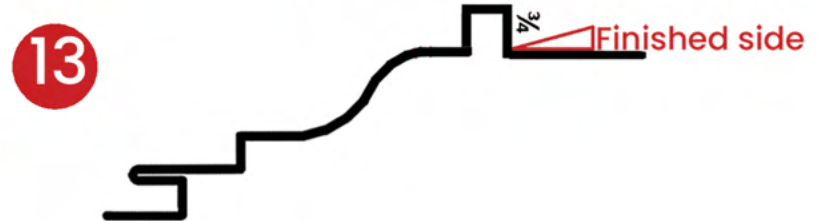
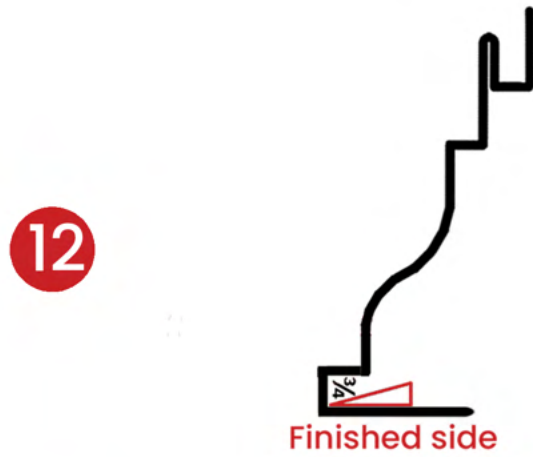
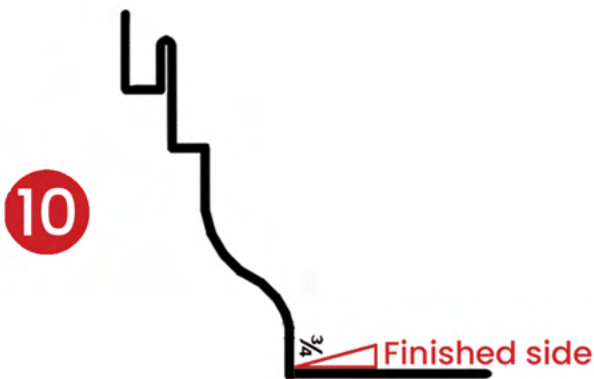
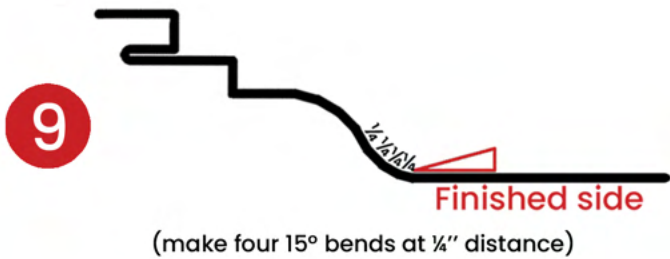
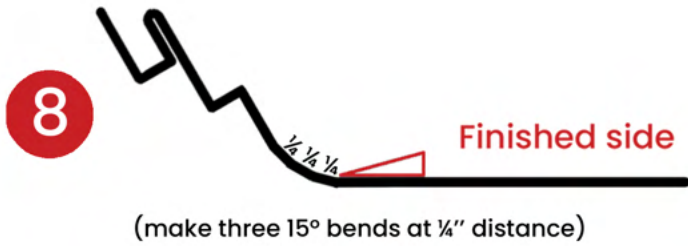
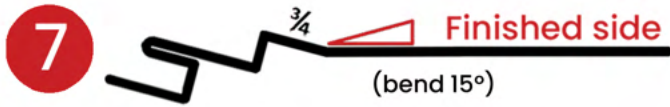

 = anvil/clamp location