

Professional Facial Steamer Series

Users Manual for F-300A/ F300B/ F300C



Please read seriously before operation.

Thank you very much for purchasing our company's products. Please read the users manual seriously or consult the professional technicians for guidance to ensure the using of the instrument correctly. If some accidents happen due to the incorrect operation, it is beyond the responsibility of The Company. For the details of the instruments, The company has the right to amend them without notice in advance. Since the products will be updated continuously, please excuse us for no notice for the improved information in the instrument.

Contents

Features	1
Functions	1
Parts explanation and installation	2
① Parts pictures	2
② Base installation for single function steamer	2
③ Base installation for steamer and magnifying lamp	4
④ Water cup installation	4
⑤ Installation for the whole facial steamer	5
Operation instruction	5
① Instruction for F300A microcomputer herbs facial steamer	5
② Instruction for F-300B herbs facial steamer	7
③ Instruction for F-300C herbs facial steamer with rotary brush	8
Maintenance	10
Specifications	10

FEATURES

F-300 facial steamer series (including the F-300A, F-300B and F-300C). This series are composed of metal shell , stainless steel base, fashionable glass water cup, copper spray pipe and so forth. Therefore, it is featured with solid structure, durability and good shape. The special stainless steel base guarantees the stability and safety in high temperature, and it will not result in oxidation or re-composition in high temperature, so as to avoid some oxidised and heavy metal atoms from some traditional material in high temperature when they are at work, to harm the skin. Hence, it can guarantee the requirement for cleanness of vapor in beauty treatment. The spray head can rotate at various angles, which make the operation more easily. Apart from the basic herbs function, it is also equipped with time pre-set, five levels spray adjustment, and an automatic water level detection. Besides, it aslo equipped with maximum and minimum water level alarming system, so as to prevent the damage for heater parts when the water level is too low, or prevent the users from opening the steamer due to their carelessness when there is no water in the water cup.

FUNCTIONS

1. Intenerate the necrotic skin cells for cleaning in the subsequent treatment.
2. Open up the skin pores for deeper cleaning.
3. Penetrate into pores to soften and clean the grease, black head, make-up residues and dirt.
4. Help skin pores release toxin.
5. Soften wrinkle temporarily
6. Activate the blood circulation, moisten the skin cell, improve metabolism and renew the skin.
7. Help to treat acne, stains, whiten and nourish skin by using appropriate herbs.

Parts` explanation and installation

Parts pictures

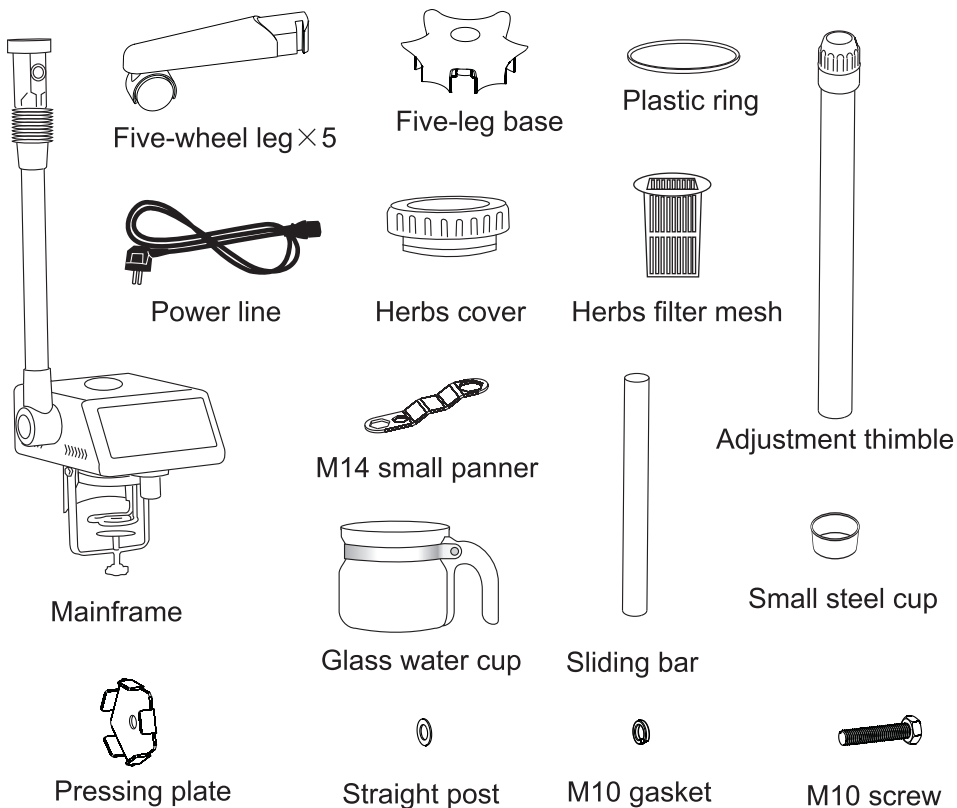

Base installation for single function steamer

First mount the five-wheel legs in the five-leg base, and then insert the straight post. (Please refer to pictures No. 1, 2, 3)

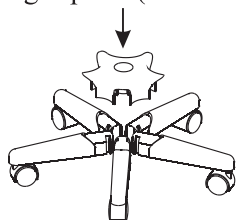

Pictures 1

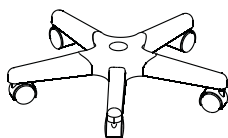

Pictures 2

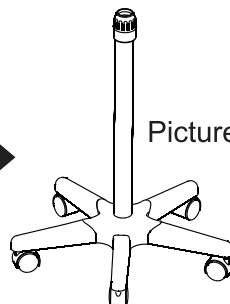

Pictures 3

Next, insert the screw which has already set the gasket and pressing plate together to the above-mentioned parts. (Please refer to picture No.4)

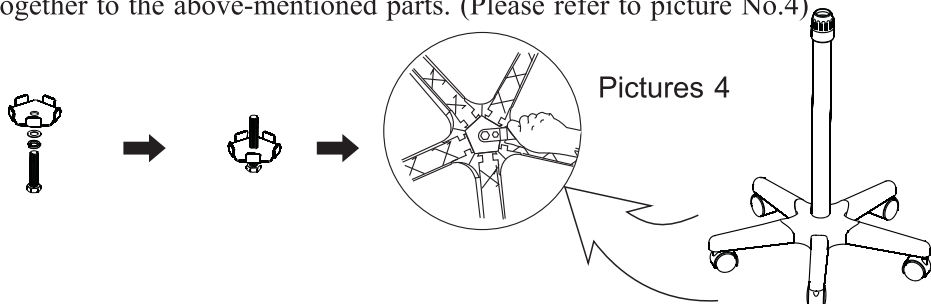

Then, twist the adjustment thimble, insert the sliding bar into the straight post and press it to its lowest position (in picture No.9), then adjust it to the suitable height and tighten it. (please refer to picture No.5,6,7).

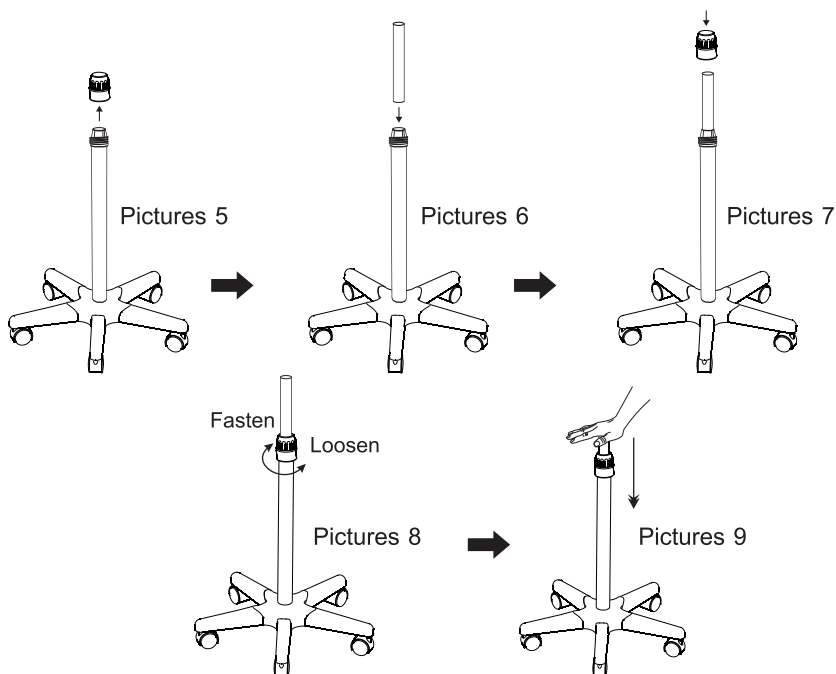

! WARNING

When adjust the height of the sliding bar, first you should hold the sliding bar with one hand, then adjust the adjustment thimble with another hand. Please do not hold the nozzle of the sliding bar to face yourself or others, so as to avoid getting hurt if the sliding bar springs out.

Base installation for steamer and magnifying lamp

First, insert the trestle into the sliding bar, then set the fixed base of magnifying lamp in the trestle. The magnifying trestle is designed specially the sliding bar.

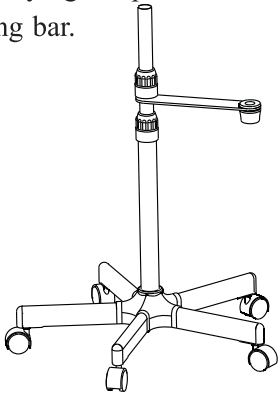

The fixed base fixed Magnifying lamp

! NOTE

This five-leg base and the magnifying lamp's fixed base is designed specially for the magnifying lamp. We will attach this package only if the customers require this package. This is not a standard fittings.

Water cup installation

First, place the plastic ring on the water cup; twist the water cup tray to a suitable place that can hold the water cup and then push it backward; then place the water cup into the mainframe, and push the tray back and then tighten it. (Please refer to following pictures No. 1 and 2)

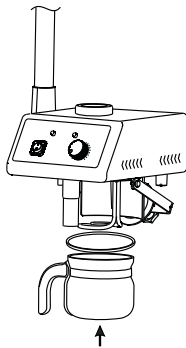

Pictures 1

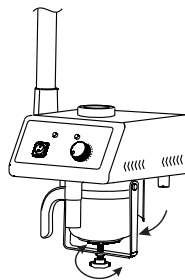

Pictures 2

! WARNING

The water cup is designed specially for this series steamer. Please do not use other similar water cups to place into this steamer, for the similar water cups will leak the gas or water easily and cause accidents.

Installation for the whole facial steamer

Please install the steamer onto the sliding bar.(Please see in the following picture No.1 and 2)

Or install the steamer on the multiple beauty instrument to use.(Please see picture No.3 below)

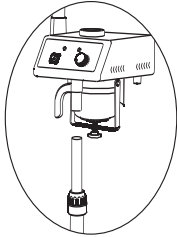

Pictures 1

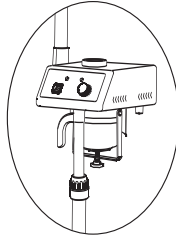

Pictures 2

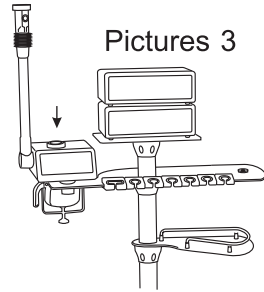

Pictures 3

OPERATION INSTRUCTION

1.Instruction for F-300A microcomputer herbs steamer

F-300A Operation panel

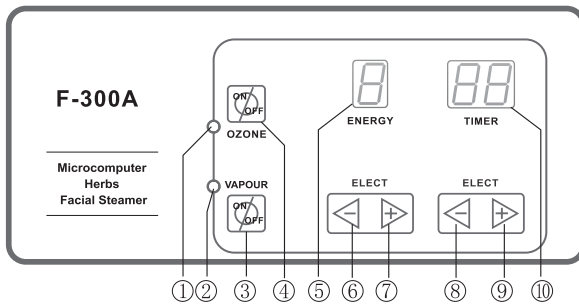

- ① Ozone indicator light
- ② Heater indicator light
- ③ Spray ON/OFF
- ④ Ozone ON/OFF
- ⑤ Energy
- ⑥ Energy decreasing bottom
- ⑦ Energy increasing button
- ⑧ Time decreasing bottom
- ⑨ Time increasing bottom
- ⑩ Timer

(1) Place the water cup upon the water cup tray and then tighten the screw. Next, take the herbs cover lid up and pour the distilled water into the water cup. The water level should be between the MAX and MIN limit of the cup.



(2) For herbs treatment, please take out the filter mesh, put the herbs bag into the small steel cup, then place the filter mesh and cover lid back. Please see in the following picture No.3.

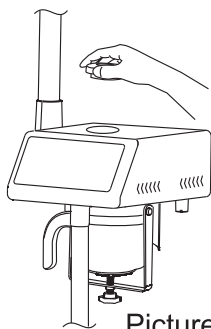

Pictures 1

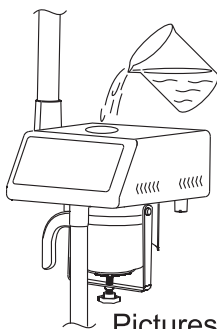

Pictures 2

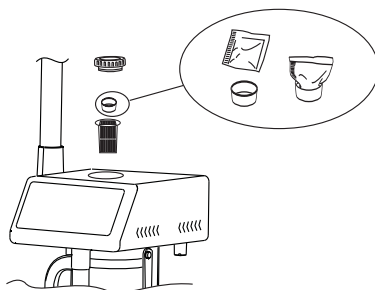

Pictures 3

(3) For fragrance treatment, please drop some essential oil in the balsam case in the spray head. The spray head can be adjusted at an appropriate angle. Please picture No.4 below.

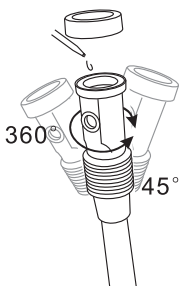

Pictures 4

(4) Connect the power plug.

(5) Automatic inspection function after opening the steamer. Press “VAPOR”, the green indication light on the left will be on. The timer will indicate “15”minutes. Energy will indicate “0”. The mainframe can check the wate level in the cup automatically; If the water level is between the MAX and MIN level, then the mainframe will standby. If the water level is lower than the MIN level, the mainframe will beep, and lock all buttons except for the “VAPOR”botton.

(6) Five level spray output

Press “+”or “-” keys under “ENERGY” to adjust the spray output from “0-5”; “5” is the biggest output. Before the vapor sprays out of the pipe, we suggest to choose “5” first, and then adjust the output level according to different requirements.

(7) Time setting

Press “+”or “-” keys under “TIMEER” to set time whose range is from “0-99”minutes. Default time is “15”minutes once the instrument’s power is on.

(8) The function of Ozone-to kill the becteria

Switch on the ;OZONE; key

--- Green lamp on the left is on.

--- Ozone lamp is working.

--- There is obvious ozone smell in the vapor along with distinct atomization.

(9) During operation, when the water level drops to the minimum limit, the mainframe will automatically response immediately and turn off the heater, lock up all the keys at the same time, except for the “VAPOR” key and accompany with alarming by constant buzzing sound. Besides, it won’t work until the water is added to the normal level, repress the keys to proceed the operation.

(10) After the preset working time is up, the mainframe will switch off “VAPOR” key automatically and buzz 5 times, and the preset time resumes to 15 min. The mainframe stands by and won’t work under this status.

2.Instruction for F-300B herbs steamer

F-300B Operation panel

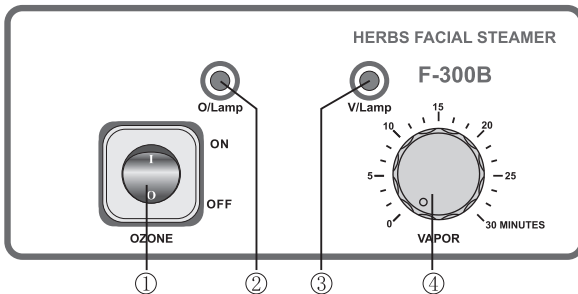

- ① Ozone ON/OFF
- ② Ozone indicator light
- ③ Spray ON/OFF
- ④ Timer

(1). Place the water cup upon the water cup tray and then tighten the screw. Next, take the herbs cover lid up and pour the distilled water into the water cup. The water level should be between the MAX and MIN limit of the cup. (Please refer to picture No 1 and 2 in page 4)

(2). For herbs treatment, please take out the filter mesh, put the herbs bag into the small steel cup, then place the filter mesh and cover lid back. Please see in the following picture No.3 in page 5.

(3). For fragrance treatment, please drop some essential oil in the balsam case in the spray head. The spray head can be adjusted at an appropriate angle. Please picture No.4 below in page 5.

(4) Connect the power plug.

(5) Switch the “VAPOR” button to right

--- “V/LAMP” turns on.

--- the mainframe starts to work.

--In about 6 minutes, vapor will spray out from the nozzle. At this moment, turn on the ozone button if needed
 --- Set the time for working; the maximum working time can be set 30 minutes at the most.

(6) Turn on the “OZONE” button.

--- “O/LAMP” turns on.

---Ozone pipe turns on and starts working.

---There is obvious ozone smell in the vapor along with distinct atomization.

(7) During the working process, when water in the cup will drop as the vapor spray out constantly. When the water level reaches the MIN limit, please switch off the “VAPOR” button first and turn off the power, then take up the herbs cover lid after the vapor stops coming out, add some distilled water, and switch on to resume operating

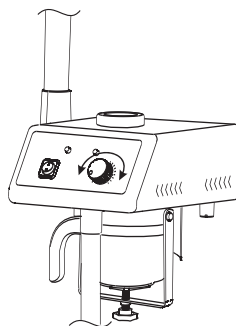

3. Instruction for F-300C herbs facial steamer with rotary brush

F-300C Operation panel

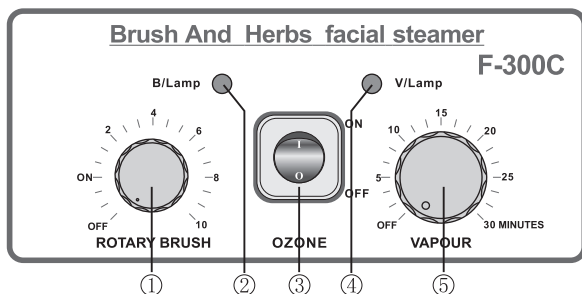

- ① Rotary brush ON/OFF (speed adjustment)
- ② Indicator for rotary brush
- ③ Ozone ON/OFF
- ④ Vapor working indicator
- ⑤ Timer

(1). The function and operation of F-300C steamer is the same as F-300B. Its operation instruction can refer to F-300B.

(2). Instruction for using the rotary brush

--First insert the brush into the brush handle. There are five different brushes for different purpose of body treatment.

--Switch the Rotary Brush button to ON, then the working light is on. Rotary speed can be adjusted according to different rotation speed. Now, the beauty treatment can start.

(3). Please check the brush has been inserted into the brush handle firmly before any rotary brush starts to work.

(4). When the brush touches the customer’ s skin, please slow down its speed

first, so as to avoid any customer's discomfortness.

(5).After each body treatment, please take out all used brushes, clean and sterilize them, and keep them in a dry environment.



CAUTIONS

1. If you need to adjust the height of machine, you should hold tightly the sliding bar with one hand, and twist the adjustment thimble with another hand. Please do not hold the nozzle of the sliding bar to face yourself or others, so as to avoid getting hurt if the sliding bar springs out.

2. The protector is used to prevent scald by accidental touching the stainless steel cup while working. Please do not take off the protector. If the protector damages, please return it back to fix.

3. The water cup should be place appropriately. Please pay attention to the position of the rubber ring, which can not be rolled up or folded; otherwise, it will leak due to the deformed plastic ring.

4. The water level should be between the “MAX” and “MIN” level limit, when the machine is at work.

5. When add water to the water cup, try to avoid spilling water over the surface of the machine shell, otherwise, it will probable cause electric leakage.

6. If air or water leakage occurs during working, first switch off the “POWER” button immediately, and cut off power, then take off water cup and check whether the rubber ring is properly fixed, reinstall it. If nothing is improved, please consult the sales agent.

7. When operating the machine, nozzle must not aim at client's face until the vapor sprays out thinly and evenly, keep a distance of 40 cm from the face, vapor should spray firstly from client's jaw, then all over the face.

8. Since the ozone can kill the skin bacteria, it is not good to use for a long time; otherwise, it will harm the skin and decompose herbs' nutrition. The period of using time should be based on different types of skin.

9.During working, when water level falls below the MIN limit, there is no more water into the water cup. F-300A will automatically response immediately and turn off the heater, lock up all the keys except the “VAPOR” key and accompany with alarming by buzzing constant. It won't start to work until the water is added to the normal level, and then repress the key to proceed the operation.

10.The interior temperature controller F-300B will response automatically, cut off the power for a while. Add some water, otherwise the temperature

controller will keep operating until the heater device burns out. The machine will automatically resume to work in 1-3 minutes after adding water.

10. The machine should be well grounded.

11. Cautions for F-300C

--Rotary brush function can not be used for a long time, otherwise the brush handles will be too hot to hold. --Please do not change the rotary brush when the brush is at work

--Please do not use hand or other material to block the brush, or do not turn on this function when the hand holds the brush, when the brush is at

Since different skin requires different spray distance, the following numbers are as reference

Skin types (remedy suits case)	Distance	Time
Greasy skin, poor blood circulation	35-40cm	About 15 min
Normal skin	35-40cm	10 min
Sensitive skin, dry skin	40-45cm	5 min
Capillary vessel expansion, UV inflammation	40cm	5 min

⚠ WARNING

1. Forbid to put the greasy stuff into the water container or the herbs filter mesh, otherwise, water may spray out.
2. Forbid to spray vapor directly down to the client's face too closely, or it will cause scald.
3. Forbid to use the steamer under humid environment, like bathroom, etc.
4. Forbid to use the steamer under the sun for long time, otherwise, it will cause some un-stabilities.
5. Forbids to conduct electricity between probes directly, or it will lead to elements damages. (For F-300A)
6. Forbid to open up the machine by oneself. If there is anything unusual, please consult the sales agent, and send for skilled technicians.
7. If the electric line was destroyed, you should ask the professional maintain and exchange it avoiding dangerous, or contact the dealer for maintain.

- 8.If the supply cord is damaged, it must be replaced by the manufacturer, its service agent or similarly qualified persons in order to avoid a hazard.
- 9.This appliance is not intended for use by persons (including children) with reduced physical, sensory or mental capabilities, or lack of experience and knowledge, unless they have been given supervision or instruction concerning use of the appliance by a person responsible for their safety.
- 10.Children should be supervised to ensure that they do not play with the appliance.

MAINTENANCE

Clean the scale off from the water cup and the heater elements at least one time per week.(Please use water that contains 7% acetic acid or citric acid to clean the scale)

After operation, clear the equipment, avoid stacked greasy stuff and other matters.

Keep an eye on the water level during working.

SPECIAL ANNOUNCEMENT

- 1.Please make sure the power line is cut off when there is no water or a lack of water. To avoid any danger, forbid to connect the power when the water level is unusual. Otherwise, the users should take the responsibility if there is any accident.
- 2.Please read the detailed instructions seriously or operate the instrument with the help of the professional' s technicians.
- 3.Forbid children to use this instrument and get close to or play this instrument within an hour after the instrument stop operating.
- 4.Since this instrument works with high temperature. Forbid nobody to keep an eye on the instrument when it is working to prevent any accidents or fire.

SPECIFICATION

F-300A/F-300B

F-300C

Voltage	AC220-240V 50Hz/60Hz	Voltage	AC220-240V 50Hz/60Hz
Wattage	800W+5%-10%	Wattage	825W+5%-10%
Specification	87.5X34X35mm	Specification	87.5X34X35mm
Weight	7.5kg	Weight	8.5kg