

NIBBI CARBURETOR INSTRUCTION

THANKS FOR BUYING THE NIBBI CARBURETOR. BEFORE USING THE CARBURETOR, PLEASE READ THE INSTRUCTION CAREFULLY, INSTALL AND USE THE PRODUCT CORRECTLY.

NOTE

- This is high-precision processed product, if you need to work on it, please do so in a clean environment.
- If, in the course of adjusting or disassembling, the carburetor is damaged we as manufacturers do not accept responsibility.
- The carburetor function will be affected by factors such as air pressure, temperature, humidity and by height above sea level.
- This carburetor requires knowledge and understanding for its setup. If you lack either of these do contact a professional for advice.

EXPLANATION OF SYMBOLS:

Note Read information under this head carefully, it will help you understand the essential features.

 Follow procedure accurately to avoid damage of the carburetor.

 **NO FIRE** Make sure to stay clear of open flames so as to avoid unwanted fire.

 **INSTALLATION CAUTION** Make sure all screws are tightened properly before starting the engine.

 **READ CAREFULLY** If any information dealt with in the manual remains unclear seek professional assistance.

1-1 ACCESSORY

1 Carburetor



2 Assembly instructions



1-2 OPTION ACCESSORY

1 Manifold



2 Accelerator

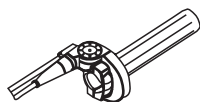

3 Throttle Cable



4 Air Filter



5 Main Jet

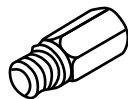

6 Pilot Jet

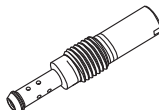

1-3 OPTION PARTS SPECIFICATION

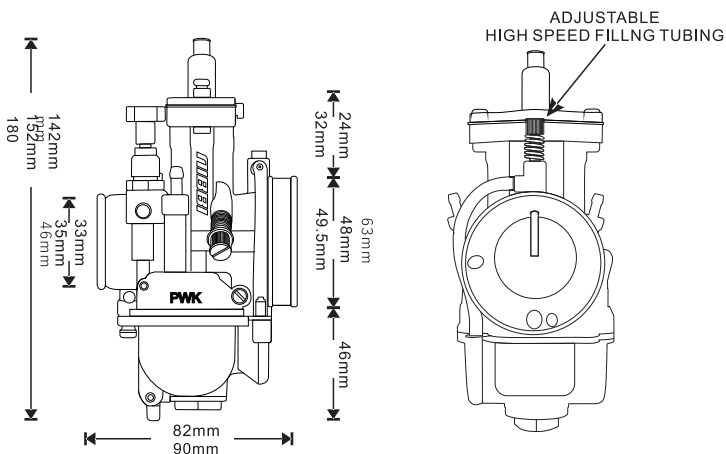

1 Pilot Jet

#30 #32 #35 #38
#40 #42 #45 #48
#50 #52 #55



2 Main Jet















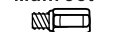



#95 #98 #100 #102 #105 #108
#110 #112 #115 #118 #120 #122
#125 #128 #130 #132 #135 #138
#140 #142 #145 #148 #150 #152
#155 #158 #160 #162 #165 #168
#170 #172 #175 #178 #180 #182
#185 #188 #190 #192 #195 #198
#200 #202 #205 #208 #210 #212
#215 #218 #220



2 THE ORIGINAL SETTING

| Carburetor | φ24 | | φ26 | | φ28 | | φ30 | | φ32 | | φ34 | | φ36 | | φ38 | | φ40 | |
|------------|-----|----|------|----|------|----|------|----|------|----|------|----|------|----|------|----|------|----|
| Stroke | 2T | 4T | 2T | 4T | 2T | 4T | 2T | 4T | 2T | 4T | 2T | 4T | 2T | 4T | 2T | 4T | 2T | 4T |
| Air Screw | 1½ | | 1½ | | 1½ | | 1½ | | 1½ | | 1½ | | 1½ | | 1½ | | 1½ | |
| Jet Needle | 3 | | 1 | | 3 | | 2 | | 2 | | 3 | | 3 | | 3 | | 3 | |
| Main Jet | #98 | | #112 | | #118 | | #120 | | #128 | | #132 | | #132 | | #135 | | #135 | |
| Pilot Jet | #32 | | #32 | | #32 | | #32 | | #32 | | #32 | | #40 | | #40 | | #40 | |

3-1 BASIC TUNING COMMON SENSE

| | | | | | |
|---|---|---|---|---|---|
| Air Screw  | Clockwise rotation the air mix screw will richer the mixture, anticlockwise rotation the air mix screw will leaner the mixture. |  |  |  |  |
| Main Jet  | The bigger the mainjet, the richer the fuel. |  |  |  |  |
| Power Jet  | The bigger the power jet, the richer the fuel. |  |  |  |  |
| Pilot Jet  | The bigger the slow jet, the richer the fuel. |  |  |  |  |

| | | |
|-----------------------------------|---|--|
| Jet Needle Setting | There are five options per needle, the higher the number, the richer the mixture | |
| Needle | Needle types are B, C, E, F, G, H, I, J, K, L, M and N. N is the leanest B is the richest with the others in between as per the list. | |
| Throttle Valve | The throttle valve is inversely proportional to the fuel concentration. If the throttle valve angle is small, the fuel is rich, otherwise the fuel is lean. | |
| THE THROTTLE VALVE OPENING | | |
| | 0 1/8 1/4 1/2 3/4 1 | |
| | | |

● For throttle closed to one quarter throttle opening

- According to the air input, change slow jet to adjust mixture.
- Running in a low speed, Set air adjustment screw to adjust mixture.

● From one quarter throttle opening to three quarter throttle opening

- According to the air input, change needle.
- Running in a middle speed, change needle adjust jet needle position to adjust mixture. change needle.

● From three quarter throttle opening fo full throttle

- According to the air input, change main jet to adjust mixture.
- Running in high speed, change power to adjust mixture

● Half throttle to full throttle (high air speed in the carb)

- Adjust mixture by changing main jet, jet needle or jet needle setting.
- Make sure to read the spark plug to check whether setting is correct or not.

3-2 BASIC TUNING NOTES

- Basic jetting of the air screw is fully in, then 1 and a half turns out. If engine runs to rich or to lean try to adjust with air screw, if this cannot be done within a few turns of the screw change slow jet.
- If mixture is too rich between closed and half throttle, and if this cannot be rectified with the air adjustment screw, go to a smaller slow jet.
- Running your engine in too rich will result in your engine not running at its best, running it too lean will eventually damage your engine's components such as piston, cylinder and head. We therefore recommend starting on the rich side when you set up your engine and work your way down to the proper setting.
- Check and read the spark plug to learn about the mixture your engine requires.
 1. Spark plug is black, or even wet: your engine runs too rich. Unburnt fuel causes soot to build up on spark plug.
 2. Spark plug is dry and grey, or even white: Your engine runs to lean. This may lead to damage of engine components such as piston, cylinder, head, spark plug caused by overheating. Go for a richer setting, use larger jets.
 3. The spark plug is brown and looks clear: Mixture is as it should be.



3-3 NATURAL ENVIRONMENTAL FACTORS

| Environment | The states of mixture | Improve the mixed gas directionality |
|-------------------|-----------------------|--------------------------------------|
| High temperatures | Rich | Rare |
| Low temperatures | Rare | Rich |
| High humidity | Rich | Rare |
| Low humidity | Rare | Rich |
| High altitude | Rare | Rich |

- When changing to a larger main jet this will affect your engine's performance at half to full throttle. Always change one factor at a time and assess the changes this has made to the engine's performance before changing something else.

- If you run an engine to lean for a longer period it is likely to overheat and suffer damage.

4 BASIC TUNING

| Problem | The states of mixture | Setting | Notes |
|---|-----------------------|--|--|
| When idling ● Engine runs erratic ● RPM is not stable | Lean | <ul style="list-style-type: none"> ● Turn air screw in clockwise to make mixture richer. ● Change to a bigger slow jet. ● Change to a smaller diameter needle to make mixture richer. | <ul style="list-style-type: none"> ● There is a possibility that a reed petal is broken ● There may be an air-leak in the inlet tract. |
| When idling ● The engine is stalled. ● Exhaust fumes are black. | Rich | <ul style="list-style-type: none"> ● Screw out the air screw to make the mixture thinner. ● Change to a smaller slow jet ● Change to a larger diameter needle to make mixture leaner | |
| When riding away ● Poor acceleration | Lean | <ul style="list-style-type: none"> ● Change to a bigger main jet. | |
| When riding away ● Engine runs erratic | Rich | <ul style="list-style-type: none"> ● Change to a smaller main jet. | |
| Between closed throttle and one quarter throttle opening ● Engine stalls and does not pick up revs | Lean | <ul style="list-style-type: none"> ● Go for a thinner needle to make the mixture richer. ● Turn the air screw in clockwise to make the mixture richer. | |
| Between closed throttle and one quarter throttle opening ● Acceleration is hesitant or irregular | Rich | <ul style="list-style-type: none"> ● Go for a bigger needle to make mixture leaner. ● Turn the air screw out anticlockwise to make the mixture leaner. ● If these two measures do not solve the problem try a smaller idle jet. | This may happen in rainy conditions in particular, pay attention to the engine temperature |
| Between one quarter and half throttle ● Engine brakes ● Engine bogs | Lean | <ul style="list-style-type: none"> ● Change the needle jet to a bigger one to make the mixture richer | Please check 3-1 Basic knowledge & Adjustment |
| Throttle between a quarter and half open ● Acceleration is bad | Rich | <ul style="list-style-type: none"> ● Change the needle jet to a smaller one to make mixture leaner. | Please check 3-1 Basic knowledge & Adjustment |
| Throttle is fully open ● RPM changes erratically ● Engine Pings, Detonation ● Spark plug is dry and white | Lean | <ul style="list-style-type: none"> ● Change main jet to a larger one (Spark plug should be brown) | a. niton could be out, that is: to much advance b. ere may also be an air leak in the inlet tract. |
| Throttle is fully open ● Engine speed rises slowly ● Engine feels flat ● Spark plug is black | Rich | <ul style="list-style-type: none"> ● Adjust mixture by using a smaller main jet. Keep checking spark plug until colour is brown. | Air filter could be blocked. Also check choke is not stuck. |
| Rapid throttle opening | Rich/Lean | <ul style="list-style-type: none"> ● Check all parts involved as described above and settlement, don't rush things. | Make sure this is not cause by a broken reed petal or an air leak in the inlet tract. |