

≡ COFLOW

PRO

EcoFlow DELTA Pro | User Manual

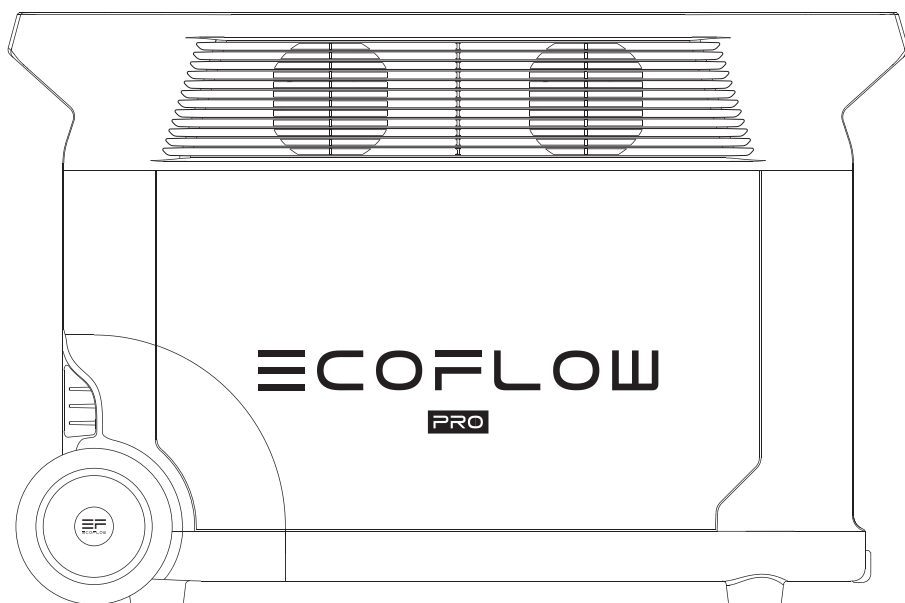

DISCLAIMER

Read all safety tips, warning messages, terms of use, and disclaimers carefully. Refer to the terms of use and disclaimer at <https://ecoflow.com/pages/terms-of-use> and stickers on the product before use. Users take full responsibility for all usage and operations. Familiarize yourself with the related regulations in your area. You are solely responsible for being aware of all relevant regulations and using EcoFlow products in a way that is compliant.

CONTENTS

1. Specifications	1
2. Safety Instructions	
2.1 Usage	2
2.2 Disposal Guide	3
3. Getting Started	
3.1 Product Details	3
3.2 LCD Screen	5
3.3 General Product Usage	5
3.4 AC Charging	7
3.5 Solar Charging	8
3.6 Car Charging	8
3.7 Using Smart Extra Battery	9
3.8 APP	9
3.9 X-Boost	9
3.10 Emergency Power Supply (EPS)	10
4. FAQs	10
5. Troubleshooting	11
6. What's In the Box	12
7. Storage & Maintenance	12

1. Specifications

General Info

Net Weight	Approximately 45kg
Dimensions	63.5 x 28.5x 41.6cm
Capacity	3600Wh, 48V
Wi-Fi	Supported
Bluetooth	Supported

Output Ports

AC (x4)	Pure Sine Wave, 3600W total (surge 7200W), 230V~ (50Hz/60Hz), 10A Max per port
USB-A (x2)	5V=2.4A, 12W Max per port, total 24W
USB-A Fast Charge (x2)	5V=2.4A 9V=2.1A 12V=1.5A, 18W Max per port, total 36W
USB-C (x2)	5/9/12/15/20V=5A, 100W Max per port, total 200W
Car Charger	12.6V=10A, 126W Max
DC5521 Output (x2)	12.6V=3A, 38W Max per port
Anderson Output	12.6V=30A, 378W Max

* A car charger shares power with the DC5521 output port, offering a maximum output of 126W.

Input Ports

X-Stream Charge Input	230V~ 2300W Max
AC Input Voltage	100-120V~ 10A, 220-240V~ 10A, 50Hz/60Hz
Solar Charger	11-150V=15A Max, 1600W Max
Car Charger	Supports 12V/24V Battery, Default 8A

Battery Info

Cell Chemistry	LFP
Cycle Life	3500 cycles to 80%+ capacity
Protection	Over Voltage Protection, Overload Protection, Over Temperature Protection, Short Circuit Protection, Low Temperature Protection, Low Voltage Protection, Overcurrent Protection

Environmental Operating Temperature

Optimal Operating Temperature	20°C ~ 30°C
Discharge Temperature	-10°C ~ 45°C
Charge Temperature	0°C ~ 45°C
Storage Temperature	-10°C ~ 45°C (optimal: 20°C ~ 30°C)

Add-ons (sold separately)

DELTA Pro Smart Extra Battery	Up to two units
EcoFlow Smart Generator	
DELTA Pro Remote Control	Wired or wireless
EV X-Stream Adapter	Charge from electric vehicle charging

2. Safety Instructions

2.1 Usage

1. Do not use the product near a heat source, such as a fire source or a heating furnace.
2. Avoid contact with liquids of any kind. Do not use in the rain or high humidity.
3. Do not use around strong static electricity or magnetic fields.
4. Do not disassemble in any way or puncture.
5. Avoid using wires or other metal objects that may result in a short circuit.
6. Do not use third-party components or accessories. Consult official EcoFlow channels if you need to replace any component or accessory.
7. When using the product, please strictly follow the operating environment temperature specified in this user manual. If the temperature is too high, it may result in a fire or explosion; if the temperature is too low, the product performance may be severely reduced, or the product may cease to work.
8. Do not stack any heavy objects on the product.
9. Do not lock the fan forcibly during use or place the product in an unventilated or dusty area.
10. Ensure the product is not hit, dropped, or heavily vibrated. Securely fasten the product when transporting to avoid damage. If severely damaged, turn off the power source immediately and discontinue using the product.
11. If you accidentally drop the product into water during use, please place it in a safe open area, and stay away from it until it is completely dry. The dried product should not be used again, and should be properly disposed of according to Section 2.2 below. If the product catches fire, we recommend that you use the fire extinguishers in the following order: water or water mist, sand, fire blanket, dry powder, and finally a carbon dioxide fire extinguisher.
12. Only clean the ports with a dry cloth.
13. Place on a flat surface to keep the product from falling over. If the product is overturned and severely damaged, turn it off immediately, place the battery in an open area, keep it away from people and combustibles, and dispose of it in accordance with local laws and regulations
14. Ensure that the product is kept out of reach of children and pets.
15. Store the product in a dry and ventilated place.
16. It is recommended to use moisture barrier bags in wet environments (for example, places by the sea or waterways) to prevent the product from getting soaked. If water is found inside the product, it must not be used or turned on again. Please take anti-electric shock measures before touching the product. Following this, place the product in a safe, waterproof and open area. Once complete contact EcoFlow Customer Service immediately.

17. This product is not recommended for powering medical emergency equipment related to personal safety, including but not limited to medical grade ventilators (hospital version CPAP: Continuous Positive Airway Pressure), artificial lungs (ECMO, Extracorporeal Membrane Please follow your doctor's instructions and consult with the manufacturer for restrictions on the use of the equipment. If used for general medical equipment, please be sure to monitor the power status to ensure that the power does not run out.
18. When in use, power supply products will generate electromagnetic fields, which are likely to affect the normal operation of medical implants or personal medical equipment such as pacemakers, cochlear implants, hearing aids, defibrillators etc. If these types of medical equipment are being used, please contact the manufacturer to inquire about any restrictions on the use of such equipment. These measure are fundamental to ensure a safe distance between the medical implants (for example, pacemakers, cochlear implants, hearing aids, defibrillators etc.) and this product while in use.
19. When the power supply is connected in normal mode to a refrigerator, power fluctuations may cause the power supply to automatically shut down. When connecting the power supply to a refrigerator that stores medicine, vaccines or other valuable items, it is recommended to set the AC output to "Always on" in the app. This helps support a continuous power supply and ensures a safe and efficient power consumption state.

2.2 Disposal Guide

1. When possible, fully discharge the battery before disposing it. Because it contains hazardous chemicals, only dispose of the battery in designated recycling channels and never with ordinary trash. Consult your local laws on battery recycling and disposal.
2. If the battery cannot be fully discharged due to product failure, contact a professional battery recycling company for further processing.
3. Please dispose of batteries that no longer recharge.

3. Getting Started

3.1 Product Details

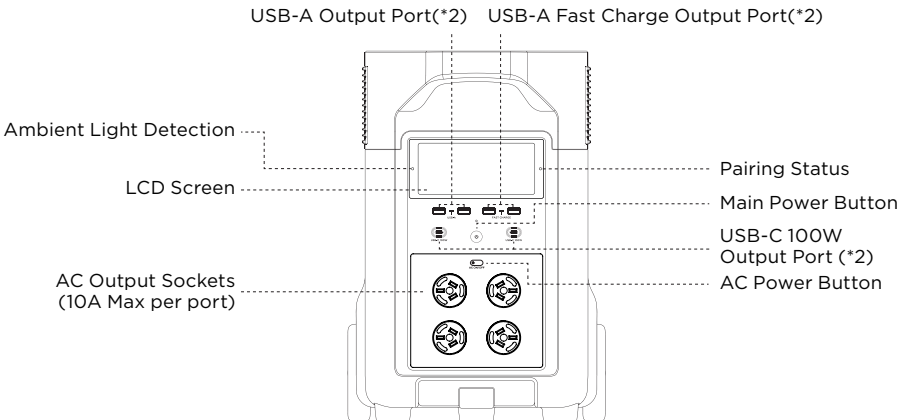

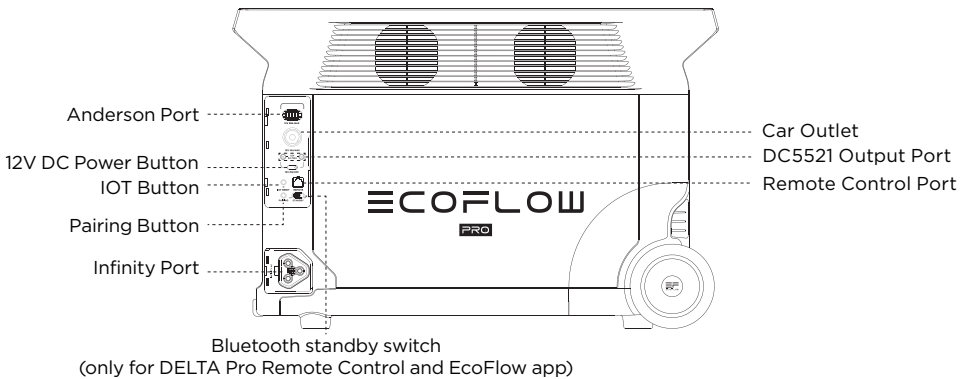
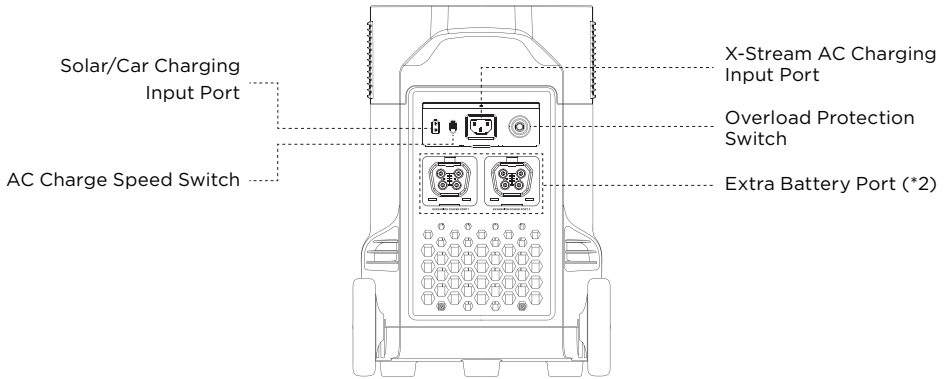

*Bluetooth standby switch: Once the Bluetooth standby switch is turned on, the Bluetooth module will continue working even if DELTA Pro is turned off. Users can turn DELTA Pro on/off remotely via the Remote Control (sold separately) or the EcoFlow app. The Bluetooth standby feature consumes some energy, so switch it off when not using.

3.2 LCD Screen

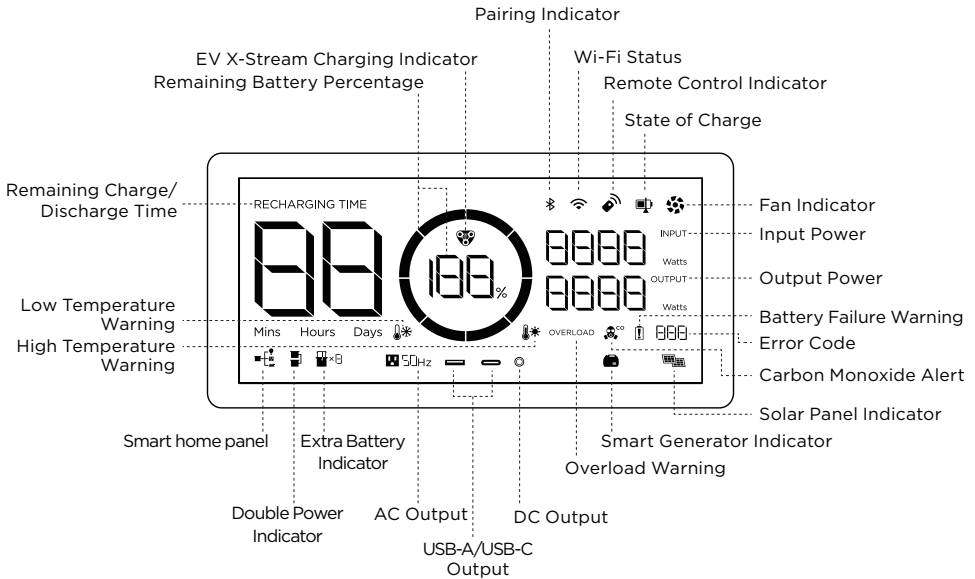

Battery Level Indicator: The ring will fill up while charging. If the product is at 0% charge, the ring will flash

Wi-Fi Status: After the IOT button has been pressed for 3 seconds, the Wi-Fi icon will flash to indicate the product is ready for pairing. Connect the product with the app, either (1) by finding the product on your phone's Wi-Fi connections or (2) by connecting the product to the internet. If the former, the icon will keep flashing; if the latter, the icon will not flash.

Error Code: Refer to the EcoFlow app for specific error codes.

Carbon Monoxide Alert: Appears whenever a connected EcoFlow Smart Generator automatically shuts off after detecting unsafe carbon monoxide levels.

* See Section 5 for more troubleshooting steps.

3.3 General Product Usage

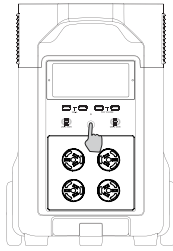

Short Press to Turn On

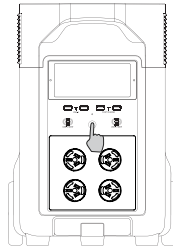

Long Press to Turn Off

Product On, Product Off, LCD Screen On

Short press the Main Power Button to turn on the product; the LCD Screen will light up and the battery level indicator icon will display.

The product enters sleep mode after 5 minutes of idle operation; the LCD Screen will automatically turn off. When the product senses any load change or operations, the LCD Screen will automatically light up. To turn the LCD Screen on or off, please short press the Main Power Button.

To power off the product, press and hold the Main Power Button.

The default product standby time is 2 hours. With other Power Buttons turned off and no other load access for 2 hours, the product will automatically shut down. The standby time can be set on the APP.

12V DC Output Port

With the Main Power Button turned on, short press the 12V DC Power Button to use the 12V DC Output port. Short press the 12V DC Power Button again to turn it off.

With the 12V DC Power Button on, the product will not automatically shut down.

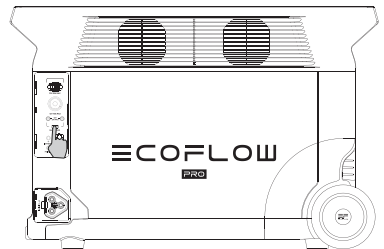

Short Press
12V DC Power Button

AC Output Port

With the Main Power Button turned on, short press the AC Power Button to use the AC Output ports. Short press the AC Power Button again to turn it off.

The default standby time of the AC Output port is 12 hours. Without any load access for 12 hours, the AC Power Button will automatically turn off.

Please turn off AC power button when not in use to save power consumption.

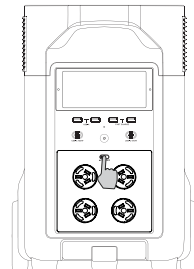

Short Press
AC Power Button

3.4 AC Charging

EcoFlow's X-Stream fast charge technology is specifically for AC charging, offering 2300W of max input power. You can control the charging power through the AC Charge Speed Switch. The default max input power for the AC charging speed is 400W, which can be modified in the EcoFlow app. In case of unusual situations where the AC input current remains higher than 20A, the X-Stream charging input port will initiate a self-protection function, and the Overload Protection Switch on the product will automatically pop up. After confirming that there is no product failure, you can press the Overload Protection Switch to resume charging.

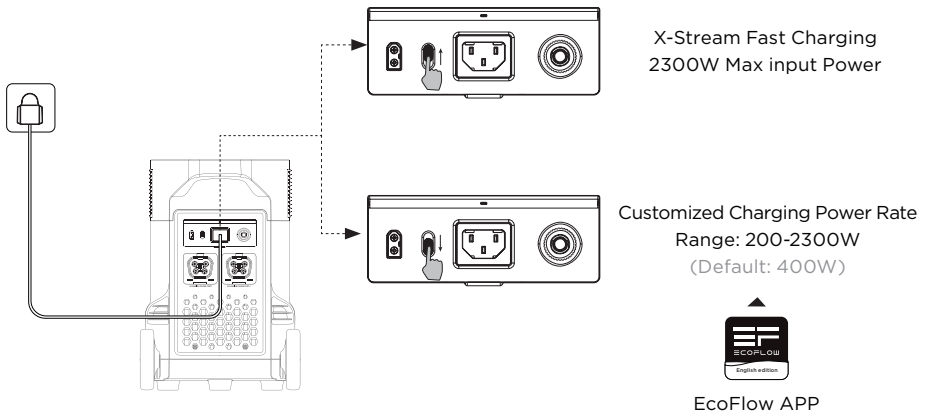
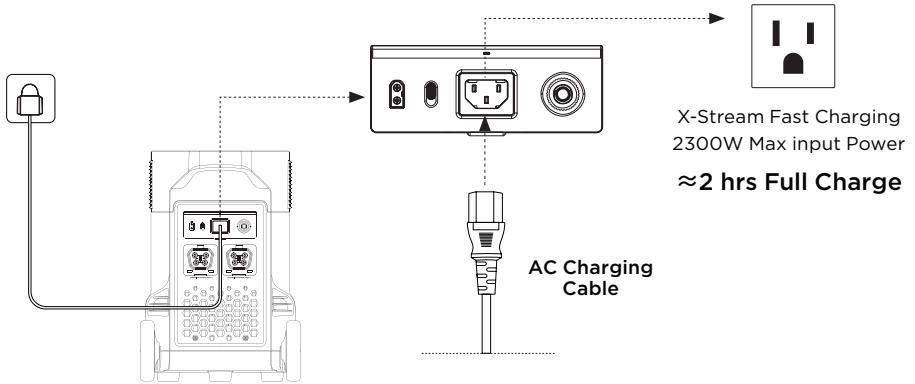

The charging power can be adjusted through the AC Charge Speed Switch on the back of the product. You can set the charging power range in the EcoFlow App.

Please use EcoFlow AC Cable for fast charging. EcoFlow takes no responsibilities for any consequences caused by failures to follow instructions, including but not limited to charging with third-party AC cables.

3.5 Solar Charging

Users can connect solar panels in series as shown in the figure to recharge the product.

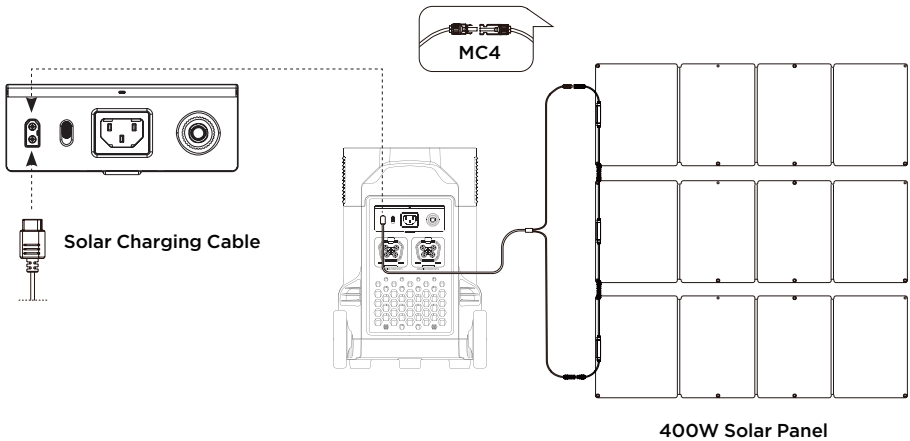

*Solar charging cable (MC4-XT60 adapter cable) is supplied separately.

When using an EcoFlow solar panel to charge the product, please follow the instructions that come with the solar panel.

Before connecting the solar panel, please ensure that the solar panel's output voltage is within 150V to avoid product damages.

3.6 Car Charging

Users can recharge the product through the Car Outlet. It supports 12V/24V car chargers and an 8A default charging current.

Please charge using the car charger after you've started the car to avoid failure to start due to insufficient car battery. In addition, please make sure that the cigarette lighter of the Car Outlet and the Car Charger Input Cable are in good condition. EcoFlow takes no responsibilities for any losses or damages caused by failures to follow instructions.

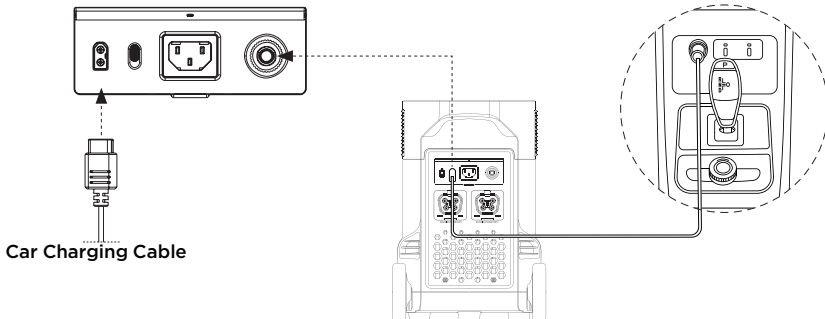

3.7 Using Smart Extra Battery

A single DELTA Pro can link with up to two Smart Extra Batteries at once for added capacity. Refer to the user manuals of the Smart Extra Battery and Smart Generator for detailed instructions.

Precautions:

1. Turn off both the Smart Extra Battery and DELTA Pro before connecting or disconnecting them.
2. Before using, make sure both DELTA Pro and Smart Extra Battery display the extra battery icon on their screens.
3. Turn off the Smart Battery before connecting or disconnecting it.
4. Do not touch the metal terminals of the Smart Extra Battery connector. If the metal terminals need to be cleaned, gently wipe them with a dry cloth.

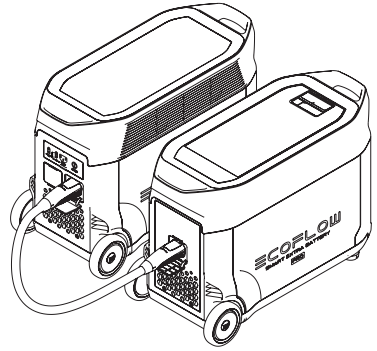

3.8 APP

The EcoFlow App gives users the ability to control and monitor EcoFlow power stations remotely.

Read the EcoFlow App user guide and access the download link here:

<https://ecoflow.com/pages/ecoflow-app>

Privacy Policy

By using EcoFlow Products, Applications and Services, you consent to the EcoFlow Term of Use and Privacy Policy, which you can access via the "About" section of the "User" page on the EcoFlow App or on the official EcoFlow website at <https://ecoflow.com/pages/terms-of-use> and <https://ecoflow.com/pages/privacy-policy>



3.9 X-Boost

With EcoFlow X-Boost technology, the product can power a 4500W Max device while the rated output power remains 3600W, avoiding operation failure due to overload protection.

X-Boost Tips:

1. X-Boost is not available when the AC output is turned on in a recharging state (in bypass mode).
2. X-Boost is not applicable for all electrical appliances; it's incompatible with appliances with strict voltage requirements and a rated power over 3600W. Appliances with voltage protection (such as precise instruments) are not supported. X-Boost mode is more suitable for heating devices. Please conduct your own tests with your devices with X-Boost enabled.

3.10 Emergency Power Supply (EPS)

The product supports EPS. When you connect the grid power to the AC Input Port of the product through an AC cable, you can power electrical devices through the AC Output Port (AC power will come from the grid and not the power station in this situation). In case of a sudden blackout, the product can automatically switch to the battery powered supply mode within 30ms. As a basic UPS function, this function does not support 0ms switching. Please do not connect the product to any device that requires 0ms UPS, such as data servers and workstations. Please test and confirm the compatibility before using the product. We recommend that you only charge one device at a time and avoid using multiple ones at the same time to avoid overload protection. EcoFlow takes no responsibilities for any device failures or data losses caused by failures to follow instructions.

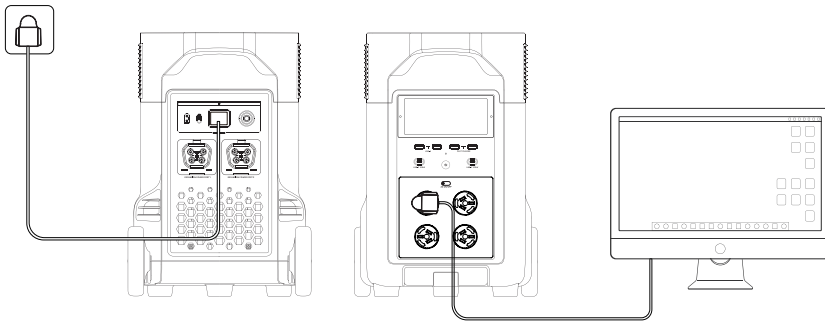

4. FAQs

1. What battery does the product use?

It uses high-quality LFP battery.

2. What devices can the product's AC output port power?

With 3600W rated power and 7200W peak power, the product's AC output port can power most household appliances. Before you use it, we recommend that you confirm the power of the appliances first and ensure the power sum of all loaded appliances is lower than the rated power.

3. How long can the product charge my devices?

The charging time is shown on the product's LCD Screen, which can be used to estimate the charging time of most appliances with stable power usage.

4. How can I know if the product is charging?

When it's charging, the remaining charging time will be shown on the LCD Screen. Meanwhile, the charging indicator icon begins to rotate with the remaining battery percentage and the input power shown on the right of the circle.

5. How to clean the product?

Please gently wipe it with a dry, soft, clean cloth or paper towel.













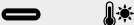







6. How to store the product?

Before storing, please turn off the product first, and then store it in a dry, ventilated place at room temperature. Do not place it near water sources. For long-term storage, please discharge the battery to 30% and recharge it to 60% every three months to extend its battery life.

7. Can I bring the product on a plane?

No.

5. Troubleshooting

Indicator	Problem	Solution
 OVERLOAD (Flashing)	USB-A Overload Protection	Resume normal operation by removing the electrical device connected to the USB-A port.
 OVERLOAD (Flashing)	USB-C Overload Protection	Resume normal operation by removing the electrical device connected to the USB-C port.
 (Flashing)	USB-C High Temperature Protection	After the product cools down, it will resume normal operation automatically.
RECHARGING TIME   (Flashing)	High Temperature Charge Protection	Charging can be resumed automatically after the battery cools down.
  (Flashing)	High Temperature Discharge Protection	The power supply can be resumed automatically after the battery cools down.
RECHARGING TIME   (Flashing)	Low Temperature Charge Protection	Charging can be resumed automatically after battery temperature rises above 5°C.
  (Flashing)	Low Temperature Discharge Protection	The power supply can be resumed automatically after the battery temperature rises above -12°C.
 50Hz OVERLOAD (Flashing)	AC Output Overload Protection	Normal operation will be resumed automatically after you remove the overloaded device and restart the product. Electrical appliances should be used within rated power. (Refer to X-Boost instructions to get more details about power limitations).
 50Hz  (Flashing)	AC High Temperature Protection	Please confirm whether the fan inlet and outlet are blocked, if not, normal operation will be resumed automatically after the product temperature drops.
 50Hz  (Flashing)	AC Low Temperature Protection	Normal operation will be resumed automatically after the product is used at optimum environmental temperatures.
 (Flashing)	Fan Blockage	Please check if the fan is blocked by foreign materials.
 OVERLOAD (Flashing)	Car Charger Overload Protection	The product will resume normal operation automatically after you remove the device connected to the car charger.
  (Flashing)	Car Charger High Temperature Protection	After the product cools down, it will resume normal operation automatically.
 (Stays On)	Battery Failure	Contact EcoFlow Customer Service

If the Alarm Prompt shows on the product LCD screen during use and does not disappear after a restart, please stop using it immediately (do not try to charge or discharge).

If you require any other assistance, please contact EcoFlow Customer Service.

6. What's In the Box

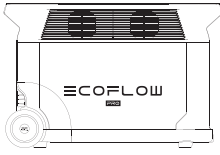

DELTA Pro

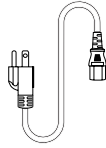

AC Charging Cable

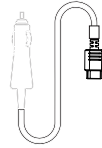

Car Charging Cable

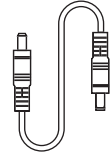

DC5521 to DC5525 Cable

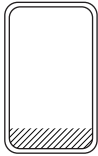

Handle Cover

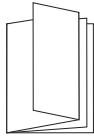

User Manual &
Warranty Card

7. Storage & Maintenance

1. Ideally, use and store the product between 20°C - 30°C (68°F - 86°F), and always keep it away from water, intense heat, and sharp objects. Do not store in temperatures above 45°C (113°F) or below -10°C (14°F) for an extended period.
2. Storing a battery with a low charge for a long period shortens its lifespan. DELTA Pro mitigates the damage by putting the battery into hibernation mode. To get the most out of the battery, make sure it is about 60% before putting DELTA Pro into long-term storage, and then once every three months, discharge the battery to 30% and recharge it back to 60%.

≡COFLOW