

# E2 PLUS SMART SWITCH LSW2E2 for lights and gates



## TOUCH, TEMPERED GLASS, BACKLIGHTING AND MULTIFUNCTION

The E2 PLUS Smart Switch use tempered glass touch screen technology and have an adjustable backlight. Combined with the ability to choose a variety of colours makes iotty a-state-of-the-art smart switch for your home or building. The iotty smart switches are the answer to the need for easy installation, flexibility, integration with the world's leading Smart Home assistants like Google Home and Amazon Echo. The smart switches connect directly to the Wi-Fi without the need of a Hub, central control unit or special cabling.



## KEY FEATURES AND BENEFITS

- Replaces any existing light switch for E502 wall box
- Neutral wire required
- Easy to install
- Works manually with and without Wi-Fi.
- Programmable backlighting
- Each key can be activated and configured individually as an on/off switch, as a push button (for external doors/hatches/relays) or as a Multi-way via Wi-Fi (3-way between iotty switches).
- Built-in Wi-Fi, it connects to your home internet Wi-Fi and allows you to easily monitor your devices from your smartphone.
- Room temperature and brightness sensor
- Set features based on location, sunrise, specific time, brightness or room temperature, activate away mode to keep burglars away, and monitor your energy consumption.
- Compatible with Amazon Alexa, Google Assistant, Siri Shortcuts and Samsung SmartThings
- Free apps and cloud services.

## AVAILABLE COLORS



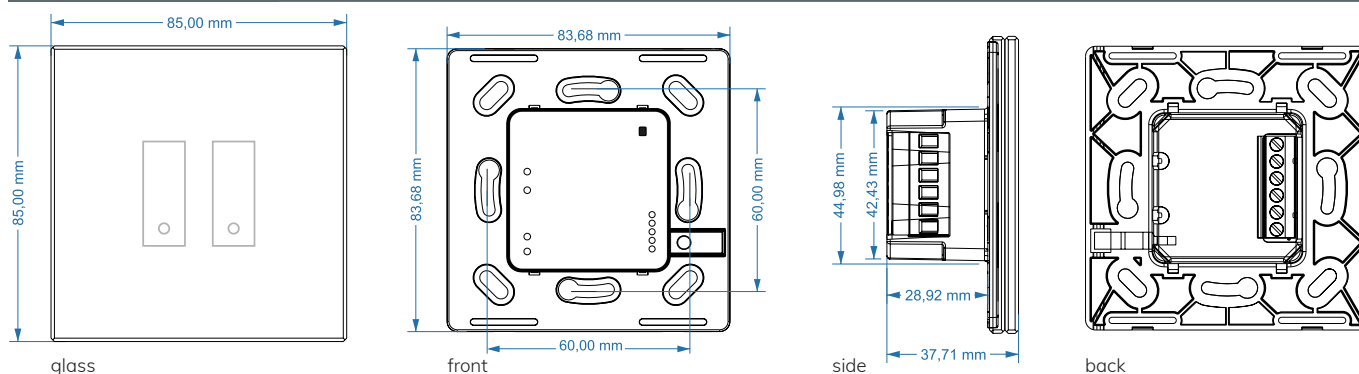

\* The yield of the color depends on many factors, including the choice of material on which it is applied. For this iotty cannot guarantee that the products have a colour which completely correspond to how they appear on the site, or printed on the list.

## TECHNICAL DATA



GENERAL

Product name	E2 PLUS Smart Switch
Model	E2PLUS
Gang number	2
Compliance	  
Manufacturer	Designed by iotty srl in Italy, Assembled in China

WIFI

Product compatibility	Wi-Fi 802.11 b/g/n/e/i, Wi-Fi direct (P2P)
Radio power	20dBm max
Wi-Fi version	WiFi 802.11
Wi-Fi	2.4GHz band

MECHANICAL

Input	230 Vac
Frequency	50 Hz
Current	Max 5A per output
Stand by power	<0.5W
Working temperature	da 0°C a +40°C
Neutral wire required	

ELECTRICAL CONNECTION SCHEME

Our switches need a 3-wire installation without any hubs or external units. Users can enjoy a simple installation experience.



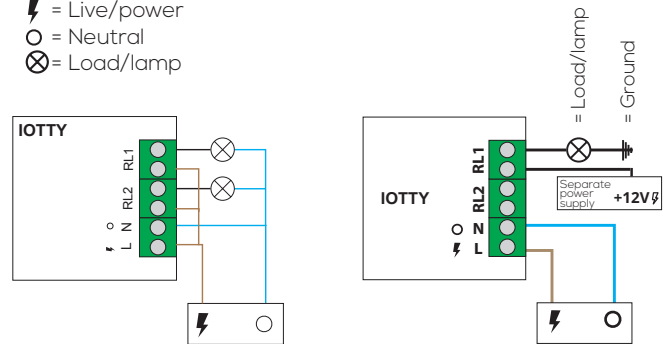



Main power supply 230 Vac  
 ⚡ = Live/power  
 ○ = Neutral  
 ⊗ = Load/lamp









SUPPORTS









- Any bulb (incandescent, fluorescent, LED) with a load of maximum 5A
- Any other resistive load of maximum 5A

AUTOMATIONS

-  **MULTI-WAY SWITCH.** To control the same light from different iotty switches using Wi-Fi.
-  **SWITCH OR PULSE ACTIVATION.** To switch on/off or use it as a push button.
-  **BACKLIGHT.** Program iotty backlight to turn on, off, or change its brightness.
-  **STATISTICS and REAL TIME ENERGY CONSUMPTION.** To keep energy consumption under control.
-  **SUN and TIME.** Set automations based on sunrise or sunset or a specific time.
-  **BRIGHTNESS and TEMPERATURE.** Set automations based on the room brightness or temperature measured with the built-in sensor.

-  **CHAIN REACTION.** Use Wi-Fi to create a central control button for all your iotty devices.
-  **WEATHER.** Set automations based on weather conditions.
-  **GIVE ME FIVE!** Place your open hand on the plate to execute specific commands.
-  **AWAY MODE.** Turn on iotty randomly so it'll seem you're at home.
-  **SCENARIO.** Send multiple commands with just one tap.
-  **GEOFENCING.** Set automations when you enter a specific geographical area.

WORKS WITH

-  INDOOR LIGHTS
-  OUTDOOR LIGHTS
-  GATES
-  BLINDS
-  SHUTTERS
-  EXTERNAL DIMMERS
-  EXTERNAL RELAYS
-  GARAGE DOORS



iotty srl  
 Via Del Laghetto, 18/20  
 33080 Porcia (PN) - ITALY

[www.iotty.com](http://www.iotty.com)  
[iotty@iotty.com](mailto:iotty@iotty.com)

Find us also on  



