



























8 x 3m POLYTUNNEL ASSEMBLY GUIDE

| 1 | 1A | 2 | 3 | 4 | 5 | 6 | 7 | 8 | 9 | p1 | p2 | p3 | p4 | p5 | p7 | p8 |
|---|---|---|---|---|---|--|---|---|---|---|---|---|---|---|---|---|
|  |  |  |  |  |  |  |  |  |  |  |  |  |  |  |  |  |
| 36PCS | 2PCS | 9PCS | 9PCS | 7PCS | 35PCS | 14PCS | 4PCS | 2PCS | 4PCS | 63PCS | 4PCS | 67PCS | 1PC | 1PC | 1PC | 1PC |

| A | B | C | D | E | F | G | H | I |
|---|---|---|---|---|---|--|---|---|
|  |  |  |  |  |  |  |  |  |
| 1PCS | 1PCS | 1PCS | 1PCS | 1PCS | 1PCS | 1PCS | 1PCS | 1PCS |

Fit all Horizontal and diagonal bars on the INSIDE of the tunnel Arch.

STEP 1

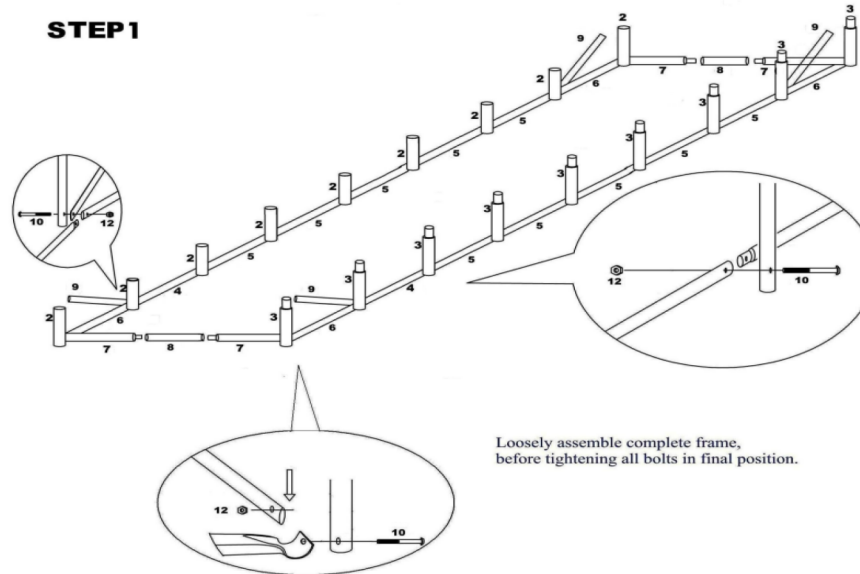

Fit all Horizontal and diagonal bars on the INSIDE of the tunnel Arch.

STEP 2

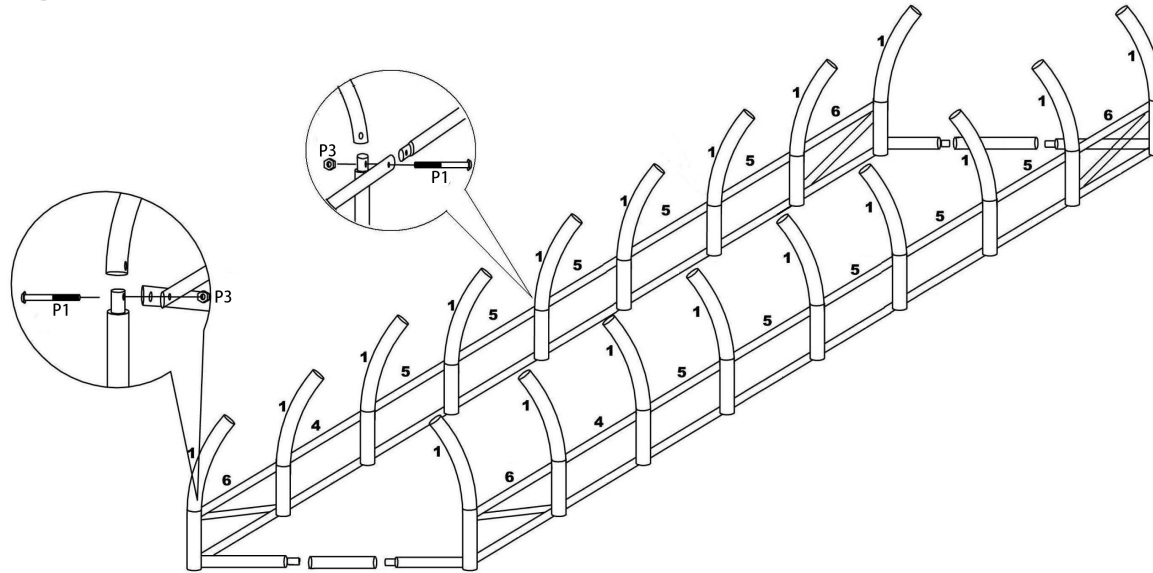

Loosely assemble complete frame,
before tightening all bolts in final position.

Fit all Horizontal and diagonal bars on the INSIDE of the tunnel Arch.

STEP3

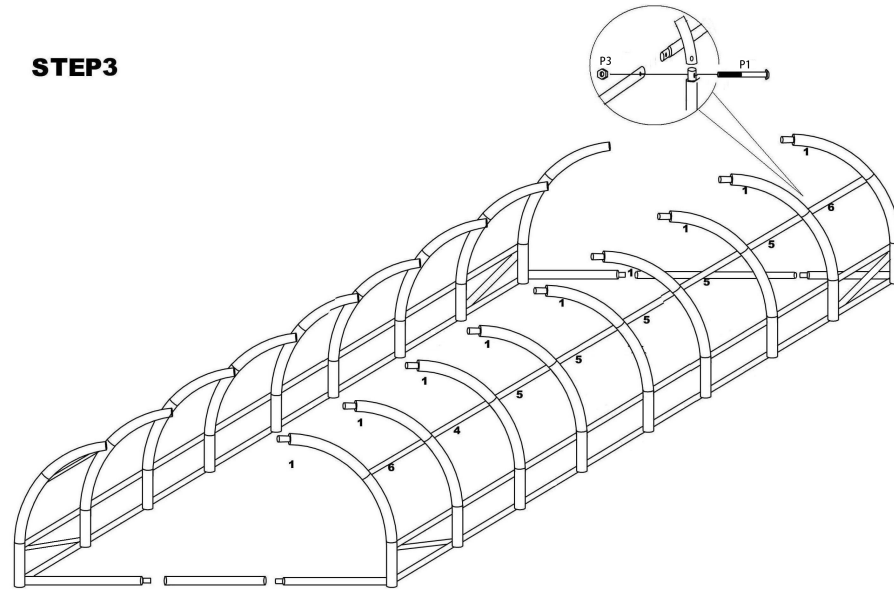

Loosely assemble complete frame,
before tightening all bolts in final position.

Fit all horizontal and diagonal bars on the INSIDE of the tunnel Arch.

STEP 4

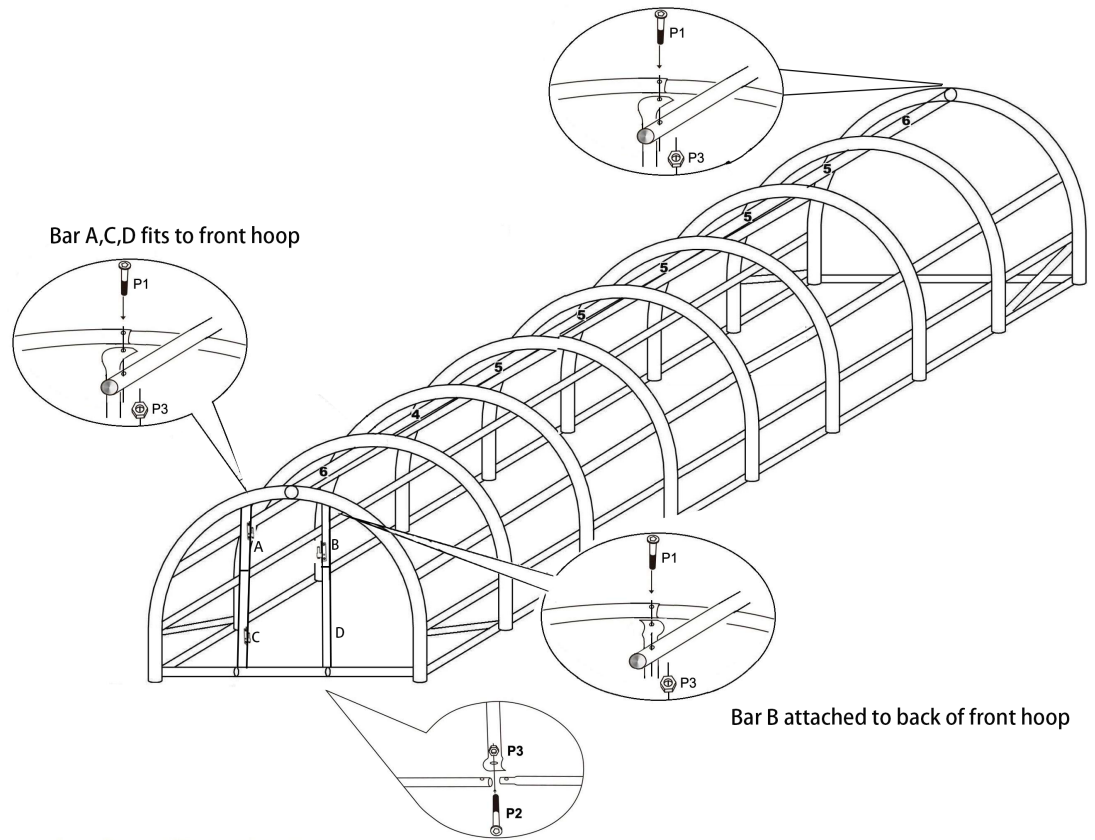

Loosely assemble complete frame,
before tightening all bolts in final position.

Fit all Horizontal and diagonal bars on the INSIDE of the tunnel Arch.

STEP 5

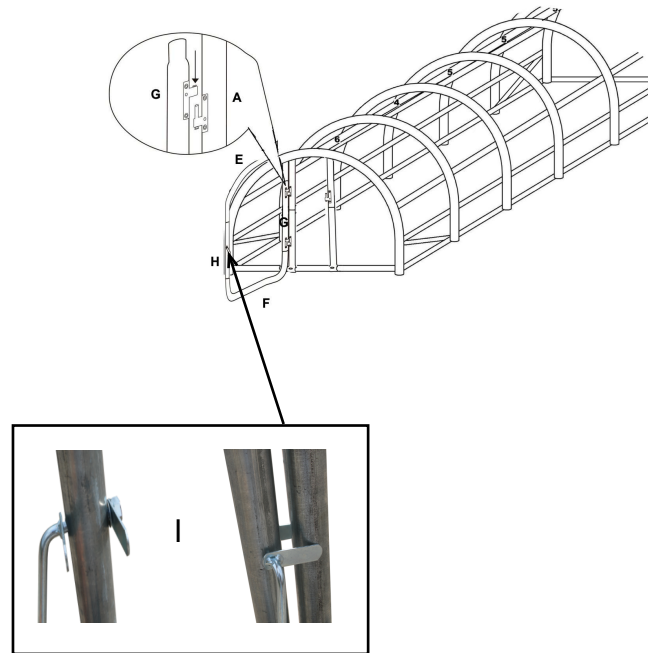

Fit all Horizontal and diagonal bars on the **INSIDE** of the tunnel Arch.

STEP 6

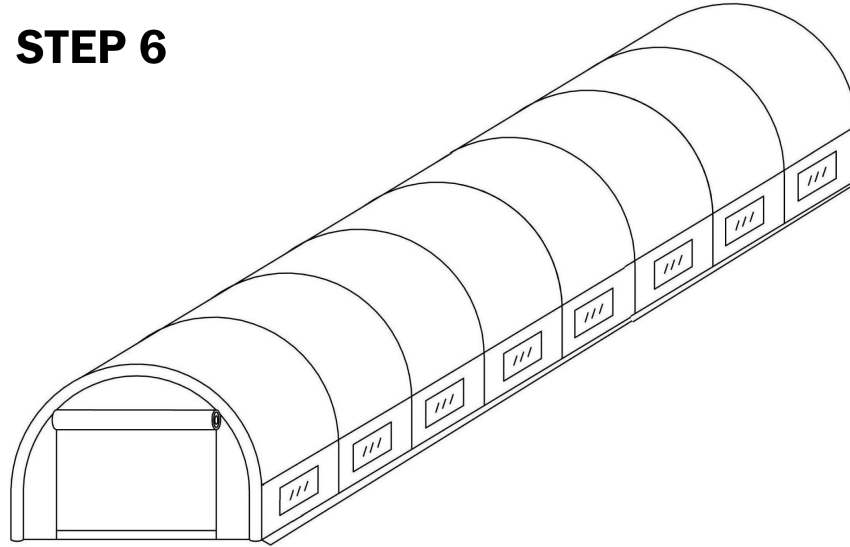

- 1) Please carefully follow the assembly instructions.
- 2) 2-3 people are recommended for final assembly.
- 3) Attach the cover to the frame using the ties located on the inside cover, hot spot tape (not supplied) may also be used. The ground skirt can be buried and weighted or surface mounted and weighted. Care must be taken to ensure weighting applied (locally sourced) is adequate to cope with weather conditions.