

















8 x 3.5m POLYTUNNEL ASSEMBLY GUIDE

NO.	1	2	3	4	4a	5	6	6a	7	8	9
											
	14pcs	7pcs	14pcs	15pcs	10pcs	5pcs	2pcs	2pcs	4pcs	4pcs	4pcs

P1	P2	P3	P4	P5	P6
					
35 + 2pcs	24 pcs	59+ 2 pcs	1pcs	1pcs	1pcs

STEP 1

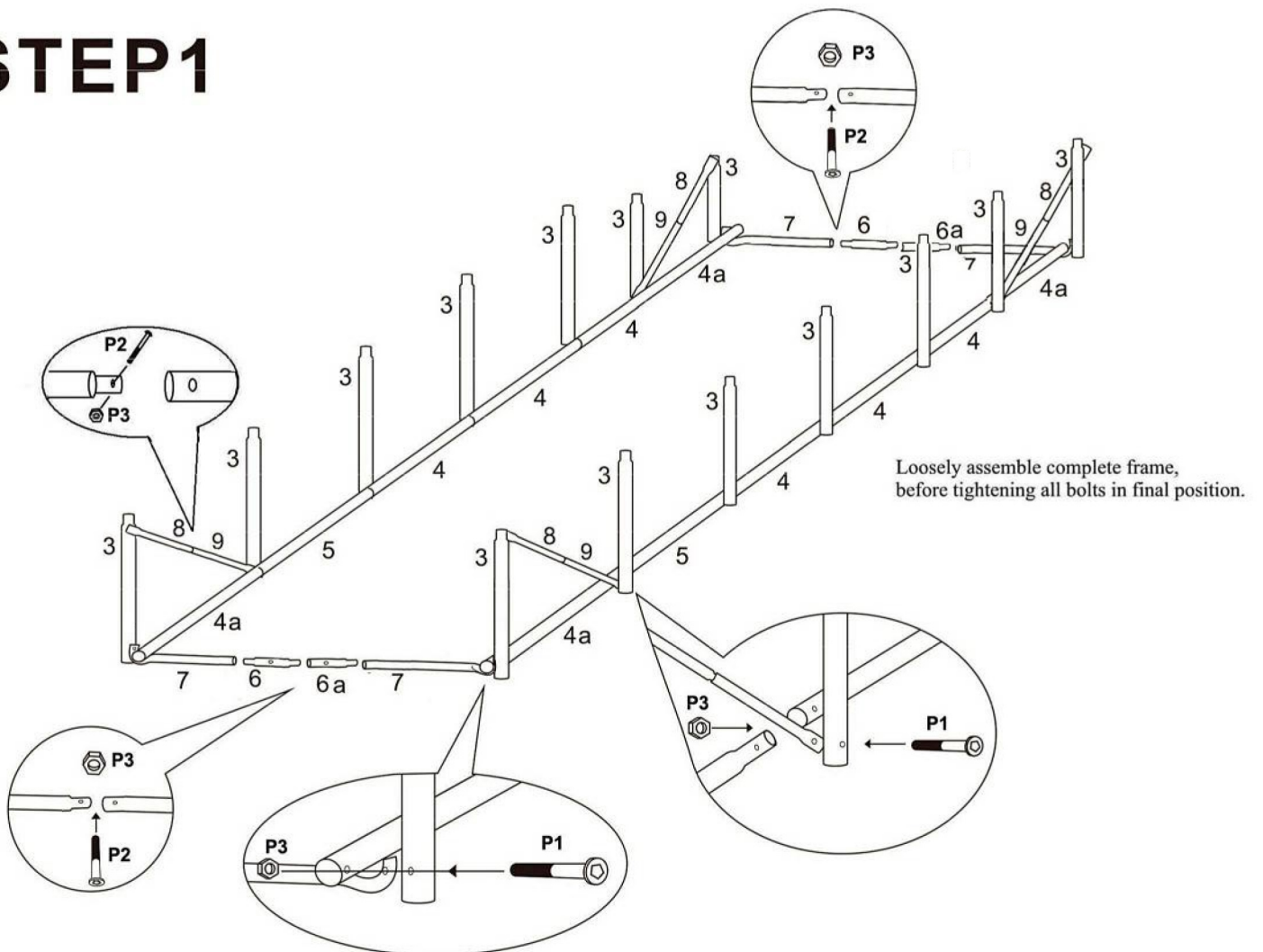

STEP 2

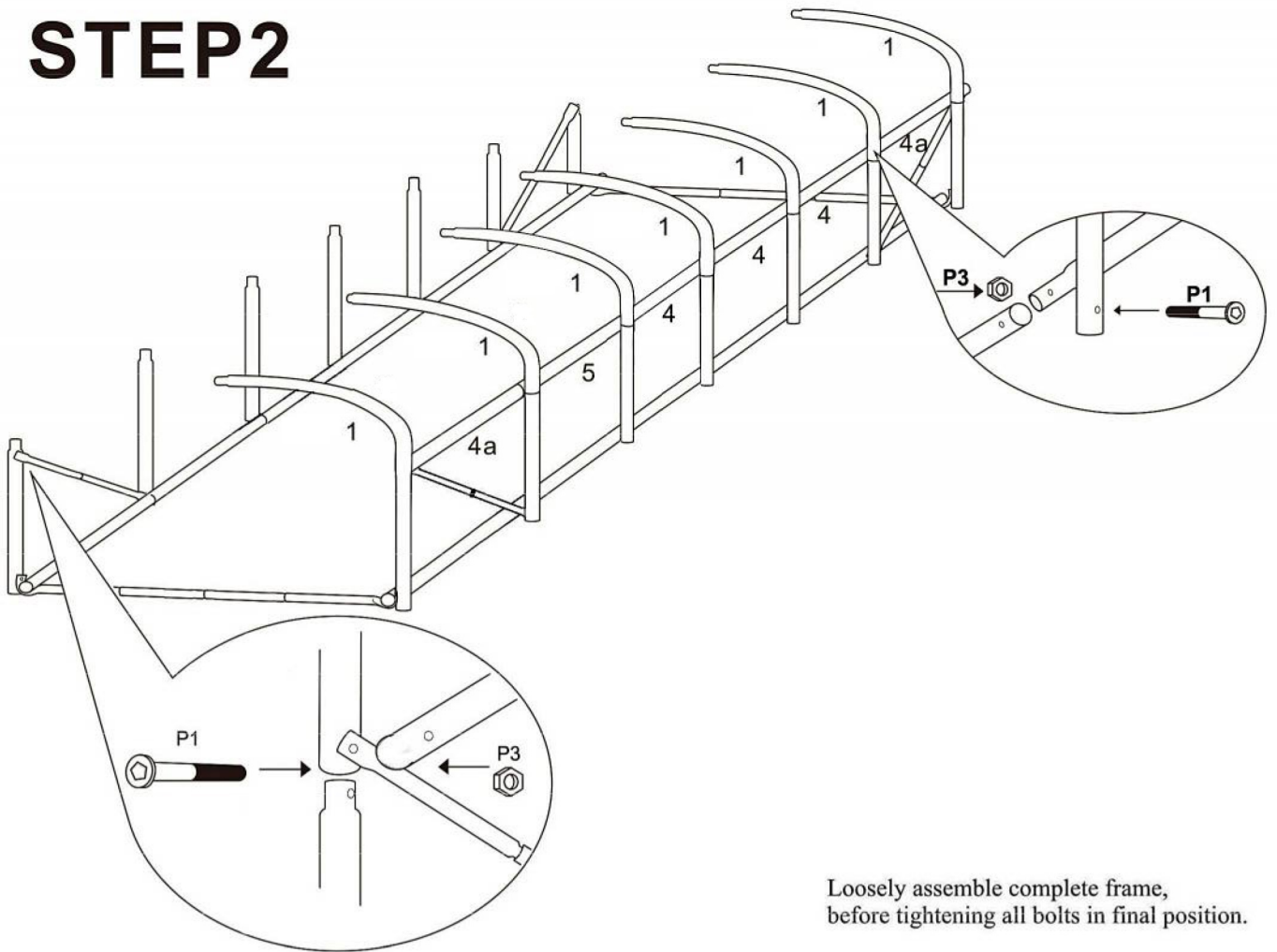

Loosely assemble complete frame, before tightening all bolts in final position.

STEP 3

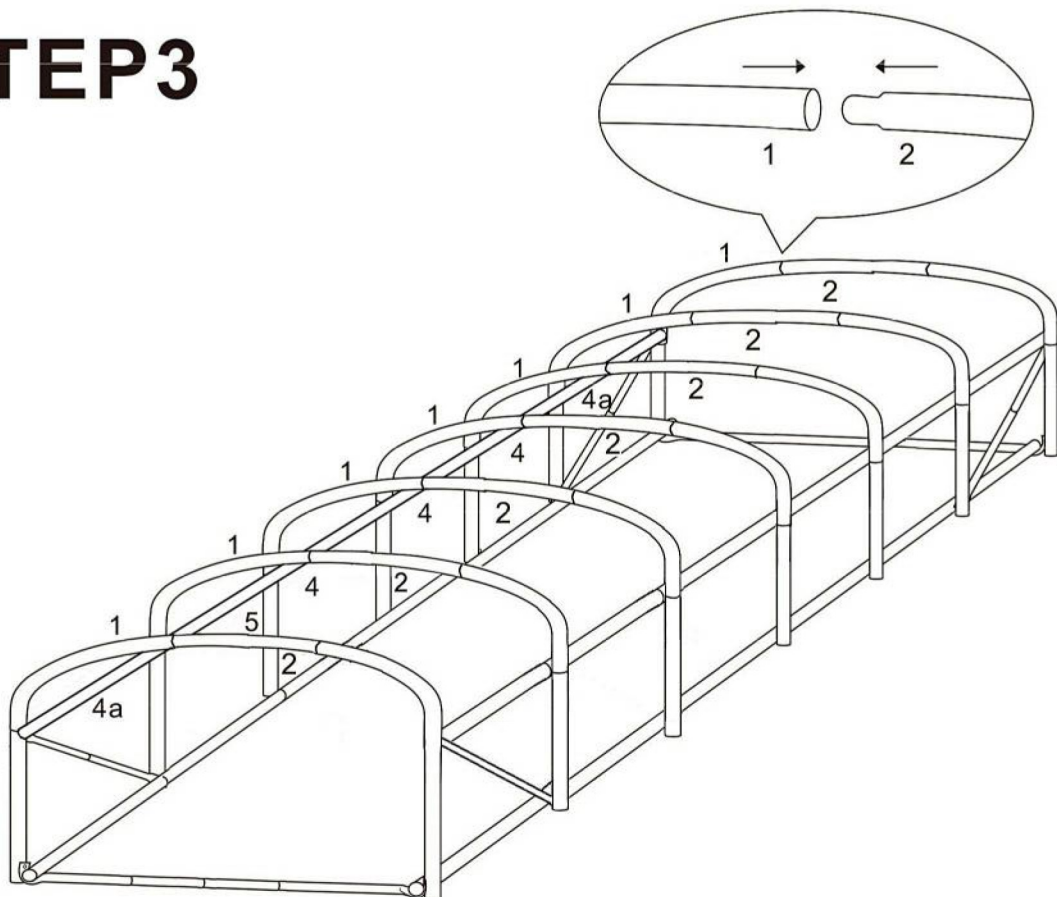

STEP 4

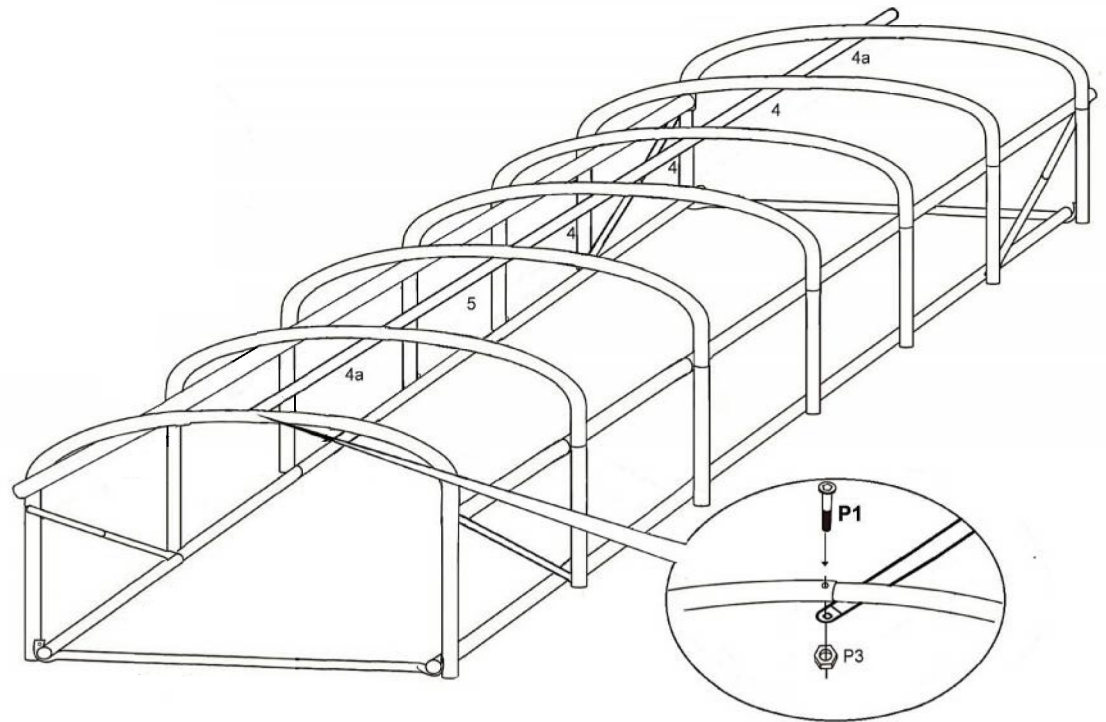

Loosely assemble complete frame,
before tightening all bolts in final position.

STEP 5

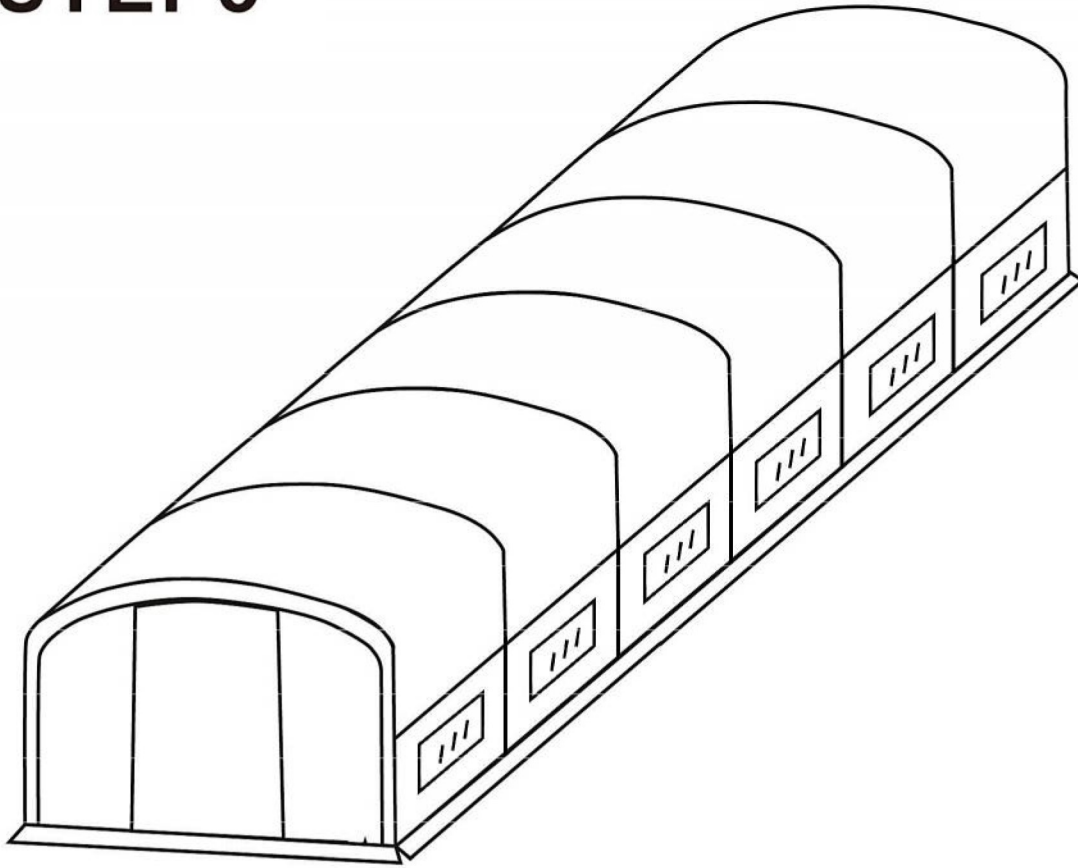

- 1) Please carefully follow the assembly instructions.
- 2) 2-3 people are recommended for final assembly.
- 3) Attach the cover to the frame using the ties located on the inside cover, hot spot tape (not supplied) may also be used. The ground skirt can be buried and weighted or surface mounted and weighted. Care must be taken to ensure weighting applied (locally sourced) is adequate to cope with weather conditions.

*Additional Installation & Anchorage Accessories Available
From Our Online Shop.*