



THE VERSATILE POWER OF STEAM

The Deluxe Food Warmer series allows operators to serve hot food quickly with the push of a button. The key is plain tap water, converted into steam, fully penetrating food from all sides. From pasta, breads, meat and seafood to poultry, eggs and vegetables, it's the perfect way to maintain the original texture, color, flavor and nutritional value of a variety of menu items.

This amazing series of equipment can be used to prepare a variety of different menu items, including pastas, breads, meats, seafood, poultry, eggs, vegetables and more. The Deluxe Food Warmer converts plain tap water into steam, with the simple push of a button, that fully penetrates foods from all sides to keep the original textures, colors, flavors, and nutrients. The end result: food that looks fresher and tastes better.

Consistent steam removes the guesswork and produces a uniform finish from one operator to the next. In addition to the instant warming button, this model of Deluxe Food Warmer features a digital controller that allows operators to program a 0-99 minute timed cycle for more complex menu items.



Let steaming expand your menu, cooking and retherming for dishes of all kinds.

Model: DFW-150 Deluxe Food Warmer



Compartment Versatility

Quickly cook and reheat many different foods, including noodles, rice, breads, meat, seafood, poultry, and more.



Fully Programmable





Fully programmable timed cycle. Easily adjust the time, number of steam shots, and amount of steam to ensure the best results.



Compact Design

Compact design and is available with a direct water hook-up or self-contained water reservoir for flexibility in installation.







No timer with self-contained water tank
Electrical Ratings
Dimensions

Model & Mfg. No.	Capacity	Approvals	Plug	Volts	Watts	Amps	Hz.	Width (A)	Depth (B)	Height (C)	Shipping Weight
DFW-100 9100101	Half-size 2 7/8" (73 mm) deep pan	 	NEMA 5-15P	120	1800	15	50/60	16 5/8" (422 mm)	17 1/4" (438 mm)	8 3/4" (222 mm)	45 lbs. (20.4 kg)
DFWT-100 9100121	Two-thirds 2 7/8" (73 mm) deep pan	 	NEMA 5-15P	120	1800	15	50/60	20" (508 mm)	17 1/4" (438 mm)	8 3/4" (222 mm)	55 lbs. (24.9 kg)



Model: DFW-100









No timer with direct water hook-up

DFW-200 9100111	Half-size 2 7/8" (73 mm) deep pan	 	NEMA 5-15P	120	1800	15	50/60	16 5/8" (422 mm)	17 1/4" (438 mm)	8 3/4" (222 mm)	45 lbs. (20.4 kg)
DFWT-200 9100131	Two-thirds 2 7/8" (73 mm) deep pan	 	NEMA 5-15P	120	1800	15	50/60	20" (508 mm)	17 1/4" (438 mm)	8 3/4" (222 mm)	53 lbs. (24 kg)
DFWF-250 9100147	Full-size 4" deep (101.6 mm) pan	 	NEMA 6-20P	208	3300	15.9	50/60	26 7/8" (683 mm)	17 1/4" (438 mm)	9 3/8" (238 mm)	75 lbs. (34 kg)



Model: DFW-200

Timer with self-contained water tank

DFW-150 9100104	Half-size 2 7/8" (73 mm) deep pan	 	NEMA 5-15P	120	1800	15	50/60	16 5/8" (422 mm)	17 1/4" (438 mm)	8 3/4" (222 mm)	42 lbs. (19.1 kg)
DFW-150 9100106	Half-size 2 7/8" (73 mm) deep pan	 	CEE 7/7	230	2800	12.2	50/60	16 5/8" (422 mm)	17 1/4" (438 mm)	8 3/4" (222 mm)	42 lbs. (19.1 kg)
DFW-150* 9100190	Half-size 2 7/8" (73 mm) deep pan	 	NEMA 5-15P	120	1800	15	50/60	16 5/8" (422 mm)	17 1/4" (438 mm)	8 3/4" (222 mm)	42 lbs. (19.1 kg)
DFWT-150 9100124	Two-thirds 2 7/8" (73 mm) deep pan	 	NEMA 5-15P	120	1800	15	50/60	20" (508 mm)	17 1/4" (438 mm)	8 3/4" (222 mm)	50 lbs. (22.7 kg)
DFWT-150 9100126	Two-thirds 2 7/8" (73 mm) deep pan	 	CEE 7/7	230	2800	12.2	50/60	20" (508 mm)	17 1/4" (438 mm)	8 3/4" (222 mm)	50 lbs. (22.7 kg)



Model: DFW-150

Dimensions are for item without shipping box. Shipping weight includes item and shipping box. Items highlighted in blue are for international markets.

* Unit comes with Canadian plug assembly.

Deluxe Food Warmer | DFW

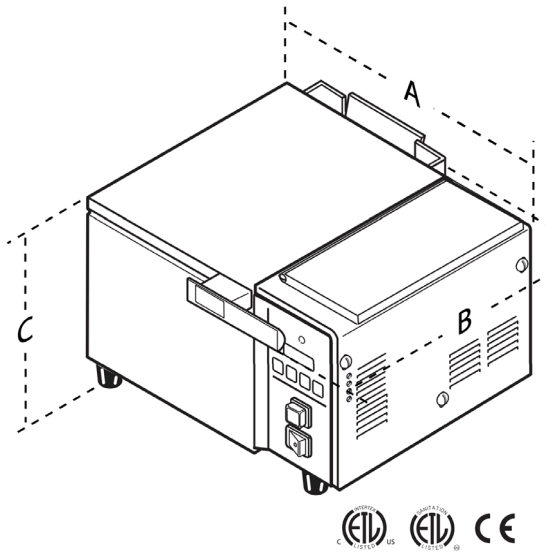

Features:

- Open compartment delivers steam from all sides.
- Available with half, two-thirds, or full size pan capacity.
- Instantly turns plain tap water into steam.
- 0-99 minute timed steam cooking with instant warming button.
- Fully adjustable pulse of steam on models with timers.
- Prepare a variety of different menu items with a consistent finish each and every time.
- Available with a self-contained water reservoir or direct water hookup.

NOTE: Units with a direct water hookup require a water pressure regulator. The psi should be between 20 and 30 psi (1.4 - 2.06 bar).

Timer with direct water hook-up

Electrical Ratings

Dimensions

Model & Mfg. No.	Capacity	Approvals	Plug	Volts	Watts	Amps	Hz.	Width (A)	Depth (B)	Height (C)	Shipping Weight
DFW-250 9100114	Half-size 2 7/8" (73 mm) deep pan		NEMA 5-15P	120	1800	15	50/60	16 5/8" (422 mm)	17 1/4" (438 mm)	8 1/4" (210 mm)	45 lbs. (20.4 kg)
DFW-250 9100116	Half-size 2 7/8" (73 mm) deep pan		CEE 7/7	230	2800	12.2	50/60	16 5/8" (422 mm)	17 1/4" (438 mm)	8 1/4" (210 mm)	45 lbs. (20.4 kg)
DFWT-250 9100134	Two-thirds 2 7/8" (73 mm) deep pan		NEMA 5-15P	120	1800	15	50/60	20" (508 mm)	17 1/4" (438 mm)	8 3/4" (222 mm)	75 lbs. (34 kg)
DFWT-250HC 9100136	Two-thirds 2 7/8" (73 mm) deep pan		CEE 7/7	230	2800	12.2	50/60	20" (508 mm)	17 1/4" (438 mm)	8 3/4" (222 mm)	50 lbs. (22.7 kg)
DFWT-150HC 9100942	Two-thirds 2 7/8" (73 mm) deep pan		BS-1363	230	2800	12.2	50/60	20" (508 mm)	17 1/4" (438 mm)	8 3/4" (222 mm)	50 lbs. (22.7 kg)
DFWF-250 9100146	Full-size 4" deep (101.6 mm) pan		NEMA 6-20P	208	3300	15.9	50/60	26 7/8" (683 mm)	17 1/4" (438 mm)	9 3/8" (238 mm)	75 lbs. (34 kg)
DFWF-250 9100156	Full-size 4" deep (101.6 mm) pan		CEE 7/7	220-240	3300	14.3	50/60	26 7/8" (683 mm)	17 1/4" (438 mm)	9 3/8" (238 mm)	75 lbs. (34 kg)



Model: DFW-250

Dimensions are for item without shipping box. Shipping weight includes item and shipping box. Items highlighted in blue are for international markets.