

LINEA ■ LIGHTING

4 Light Wall Sconce LL-WL34 / LL-WL34-FRST

ASSEMBLY INSTRUCTIONS

REMOVE ALL PARTS FROM PACKAGE, BE CAREFUL NOT
TO DAMAGE ANY COMPONENTS.

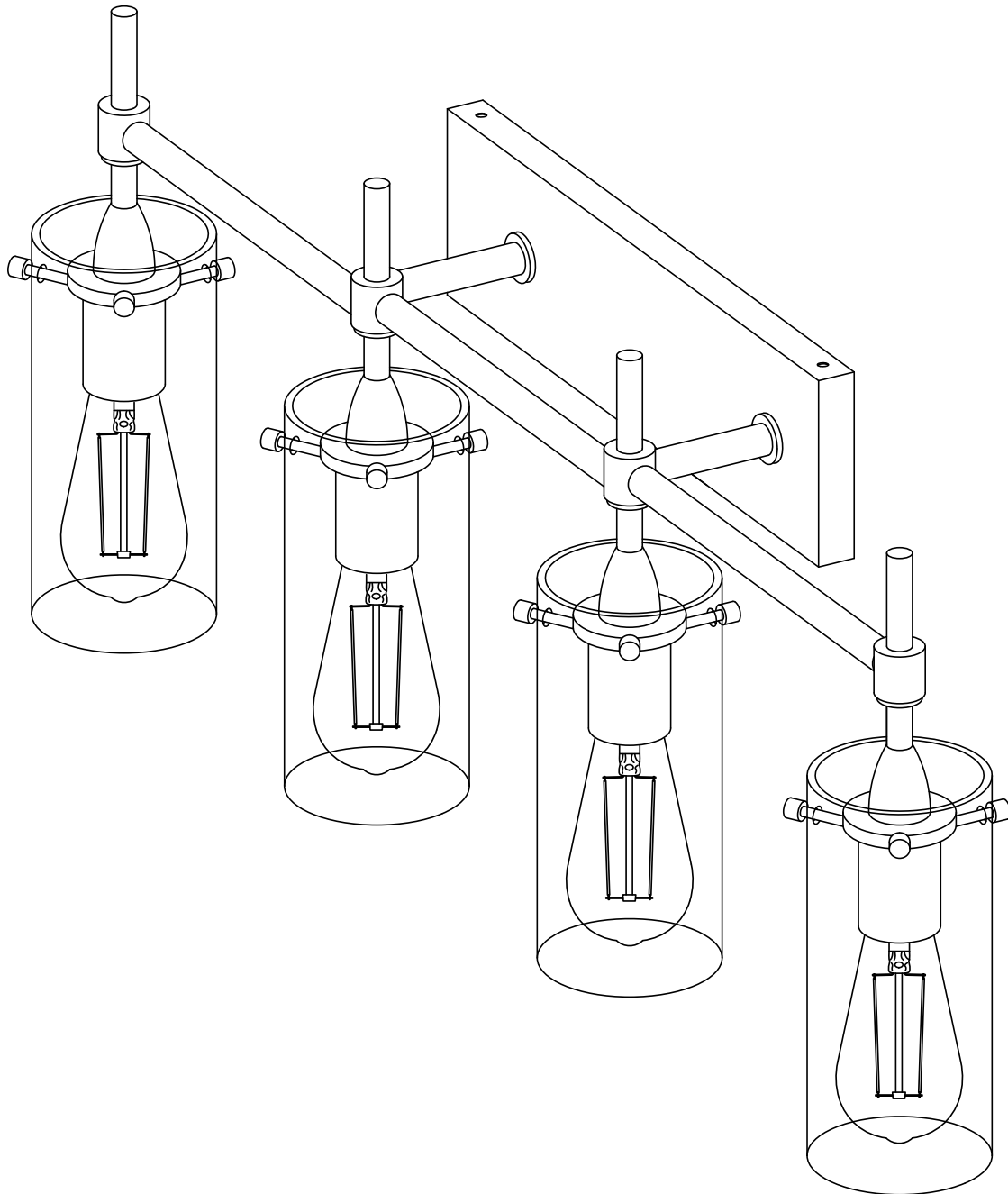

PROFESSIONAL INSTALLATION RECOMMENDED

LINEA ■ LIGHTING

4 Light Wall Sconce LL-WL34 / LL-WL34-FRST

REMOVE ALL PARTS FROM PACKAGE, BE CAREFUL NOT TO DAMAGE ANY COMPONENTS.

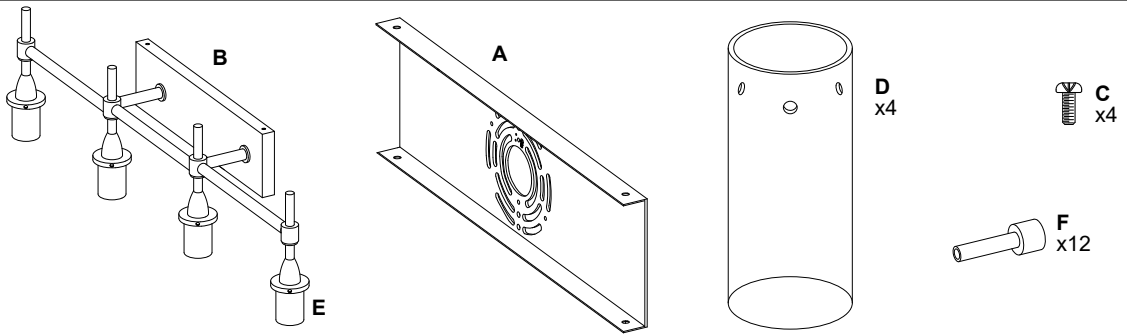

1. Measure area and determine desired mounting height.
2. Detach mounting plate [A] from backplate [B] by removing backplate screws [C].
3. Mounting plate [A] will attach to junction box.
4. Install light to wall. Linea Lighting recommends installation by a qualified electrical professional. Secure light by reattaching backplate [B] to mounting plate [A] using backplate screws [C].
5. Install the glass shade(s) [D] onto socket(s) [E] and tighten by using glass screws [F].
6. Install bulb(s) 60W max (not included).

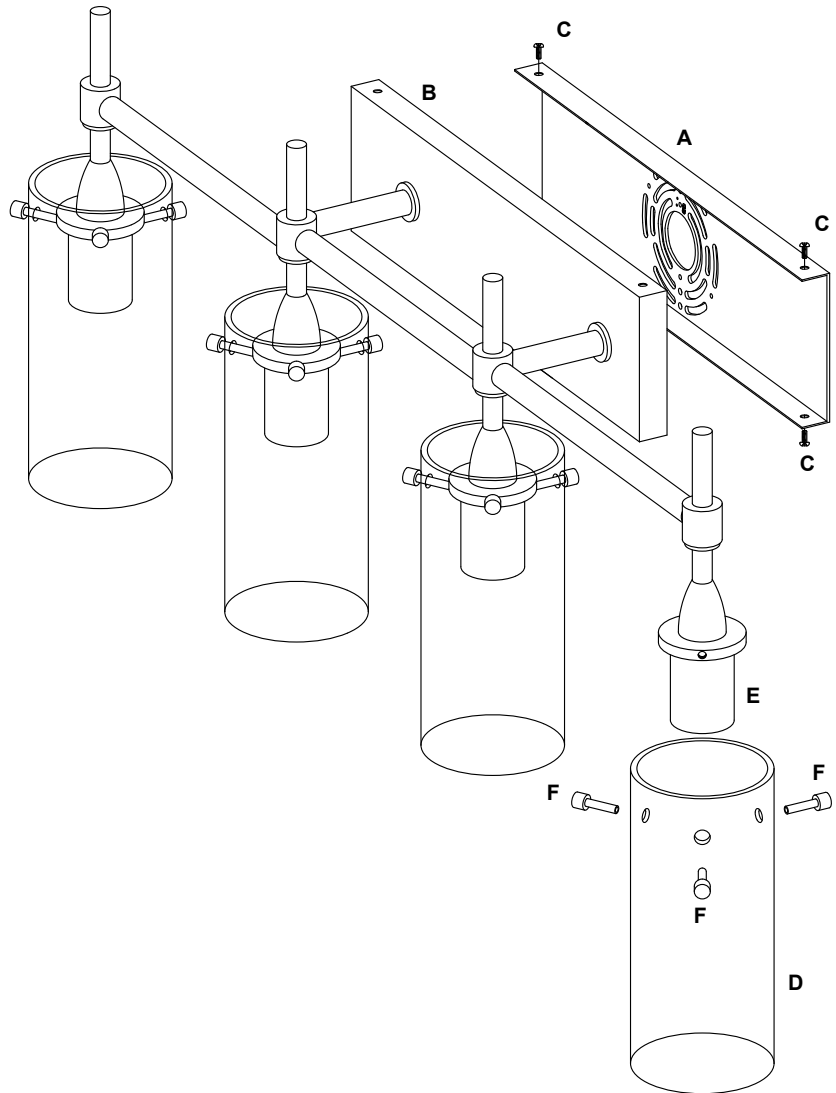

Note: Turn off switch before replacing the bulb. Make sure the bulb has sufficient time to cool down.
Do not subject the lamp to any shock while lit as shattering of glass shade may result.