

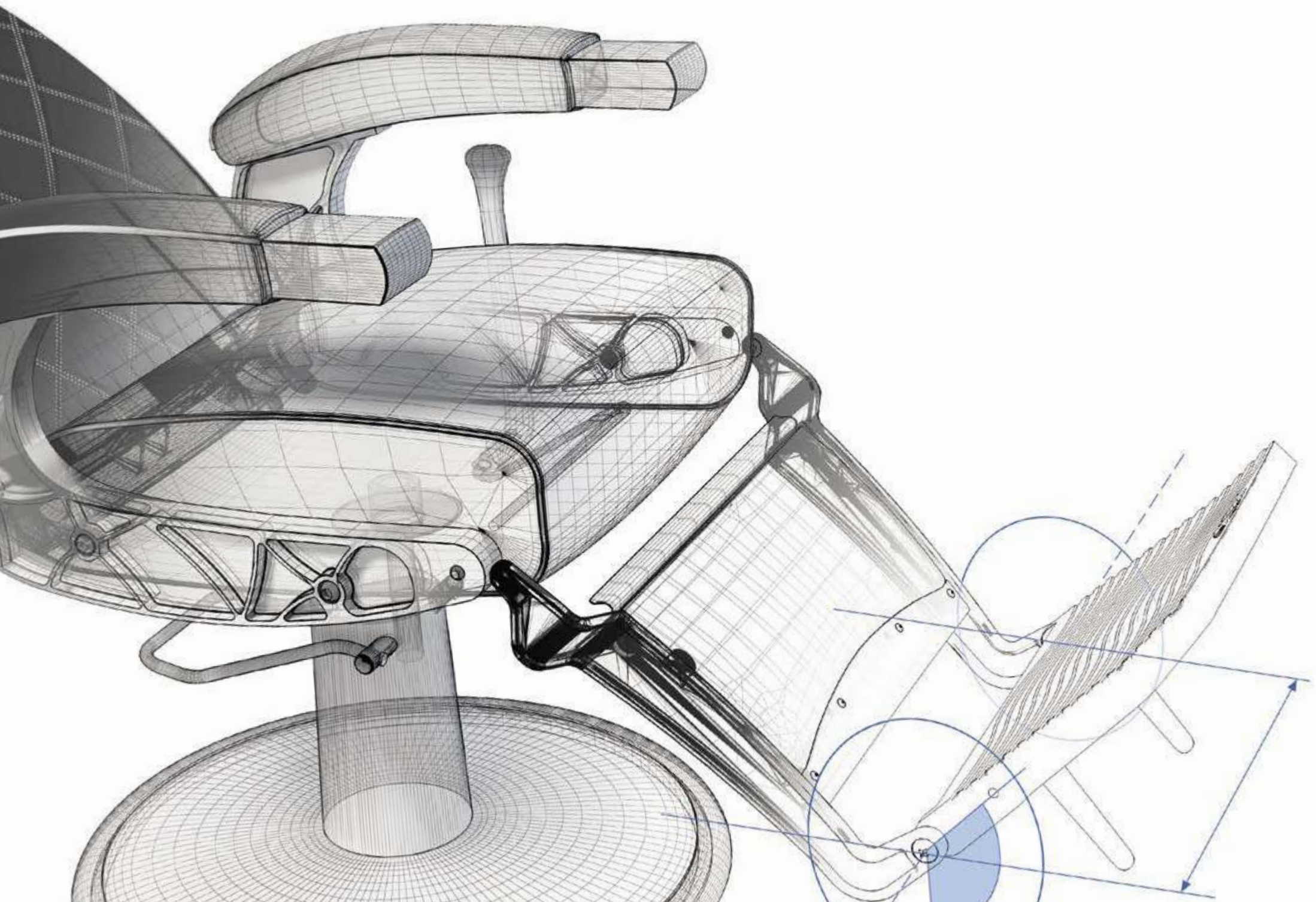

www.kappersleverancier.nl



KAPPERS LEVERANCIER

Welcome to Kappers Leverancier

ENG_ Our passion is to create effective & quality products with attractive designs.

Proximity, commitment and honesty are the values that guide us and allow us to constantly learn, advance and innovate.

We put our knowledge on the design, development and manufacturing.

Thus allowing, to transform traditional areas into creative, unique and stylish spaces.

ES_ Nuestra pasión es crear productos con diseños atractivos, de calidad y eficientes.

La proximidad, el compromiso y la honestidad son los valores que nos guían y permiten aprender, avanzar e innovar constantemente.

Ponemos todo nuestro conocimiento en el diseño, desarrollo y fabricación.

Permitiendo así, transformar áreas tradicionales en espacios creativos, únicos y con estilo.

FR_ Notre passion est de créer des produits avec des designs attractifs, de qualité et efficaces.

La proximité, l'engagement et l'honnêteté sont des valeurs qui nous guident et nous permettent d'apprendre, d'avancer et d'innover constamment.

Nous mettons tout notre savoir-faire dans la conception, le développement et la fabrication.

Permettant ainsi de transformer des zones traditionnelles en espaces créatifs, uniques et stylés.

KAPPERS LEVERANCIER

salon

changing
styles

www.kappersleverancier.nl

index

06

Collections
Colecciones
Collections

11

Barber chairs
Sillones de barbero
Fauteuils barbier

35

Styling chairs
Sillones de corte
Fauteuils de coupe

57

Shampoo units
Lavacabezas
Bacs à shampoing

83

Styling units
Tocadores
Coiffeuses

97

Stools
Taburetes
Tabourets

105

Trolleys and accessories
Carros y complementos
Chariots et compléments

117

Reception and waiting area
Recepciones y esperas
Réceptions et salle d'attente

KAPPERS LEVERANCIER

beauty

made to be
desired

www.kappersleverancier.nl

index

135 Beds
Camillas
Lits

159 Makeup
Maquillaje
Maquillage

165 Manicure and pedicure
Manicura y pedicura
Manucure et pédicure

177 Stools and trolleys
Taburetes y carros
Tabourets et chariots

183 Reception & waiting area
Recepciones y esperas
Réceptions et salles
d'attente

191 Tables and storage
Mesas y almacenaje
Tables et stockage

Organic Collection

Practicality and nature

Full of life. A perfect balance between a classic style and nature.

Llena de vida. El equilibrio perfecto entre la sensibilidad y el cuidado de lo natural.

Pleine de vie. Équilibre parfait entre la sensibilité et le soin naturel.



Robin_ p.89



Ocean_ p.40



Finch_ p.120



Basil_ p.64



Skye_ p.110



Iris_ p.111



Holly_ p.109





Garage Collection

Where passion, elegance and strength meet

A combination of design and strength.

La combinación de materiales nobles para un estilo indomable.

Combinaison de matériels nobles pour un style indomptable.



Richard_ p.87



Adrian_ p.122



Alan_ p.108



Wally_ p.106



Noah_ p.107





Barber chairs

Sillones de barbero

Fauteuils barbier

Hugo

Barber chair · Sillón de barbero · Fauteuil barbier



Hugo



Hugo B

ENG_ Let the beauty and elegance of the classic barber chair seduce you.

ES_ Dejarse seducir por la belleza del sillón clásico por excelencia.

FR_ Laissez-vous séduire par la beauté du fauteuil barbier classique para excellence.



110-150cm



Ø 68 cm

67cm

min 57 cm - max 74 cm





Hugo



White criss cross stitching
Costuras entrecruzadas blancas
Coutures surpiquées blanches

Zigzag spring seat
Asiento de resorte en zigzag
Assise avec ressorts en zigzag



Pump loading capacity up to 300 kg
Bomba con capacidad de carga hasta 300 kg
Pompe avec capacité de charge jusqu'à 300 kg

Metallic protecting ring attached to the base
Aro protector metálico cromado fijado a la base
Anneau protecteur métallique chromé et fixé à la base



Hugo B

*Some things never get old,
they just improve*

Aluminum footrest
Reposapiés de aluminio
Repose-pieds en aluminium

Die-cast aluminum side structure
Estructura lateral de aluminio fundido
Structures latérales en aluminium

Black stitching
Costuras negras
Coutures noires



Clint

Barber chair · Sillón de barbero · Fauteuil barbier

ENG_ The vintage barber chair for the most daring full of character and personality.

ES_ El sillón vintage para los más atrevidos, con carácter y personalidad.

FR_ Le fauteuil barbier vintage pour les plus audacieux, avec caractère et personnalité.

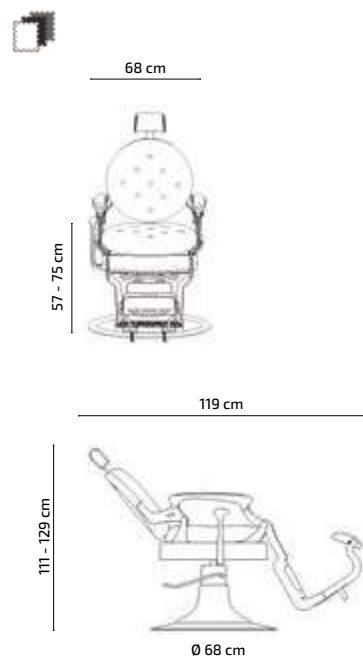

“The vintage bad boy”



Clint B



Clint BR



Clint





Pump loading capacity up to 300 kg
Bomba con capacidad de carga hasta 300 kg
Pompe avec capacité de charge jusqu'à 300 kg

Metallic protecting ring attached to the base
Aro protector metálico cromado fijado a la base
Anneau protecteur métallique chromé et fixé à la base

Vintage pump cover painted to match the structure
Embellecedor de bomba vintage pintado a juego con la estructura
Enjoliveur de pompe vintage peint assorti avec la structure





Towel holder
Soporte para toalla
Support pour serviette

Aluminum structure
Estructura de aluminio fundido
Structure en aluminium

Headrest support
Soporte para reposacabezas
Support pour repose-tête



Kirk B

Barber chair · Sillón de barbero · Fauteuil barbier

ENG_ The dazzling vintage barber chair for the most passionate, designed to charm.

ES_ El sillón de barbero vintage radiante para los más apasionados, diseñado para enamorar.

FR_ Le fauteuil barbier vintage rayonnant pour les plus passionnés, conçu pour en tomber amoureux.

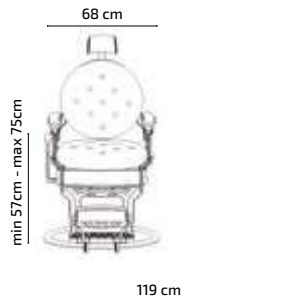

Vintage pump cover painted in black
Embellecedor de bomba vintage con lacado negro
Enjoliveur de pompe vintage laqué noir



Towel holder
Soporte para toalla
Support pour serviette



Pump loading capacity up to 300 kg
Bomba con capacidad de carga hasta 300 kg
Pompe avec capacité de charge jusqu'à 300 kg



Metallic protecting ring attached to the base
Aro protector metálico cromado fijado a la base
Anneau protecteur métallique chromé et fixé à la base



Headrest support
Soporte para reposacabezas
Support pour repose-tête



Jones

Barber chair · Sillón de barbero · Fauteuil barbier

ENG_ Making a difference, the vintage barber chair that evokes a passion.

ES_ Marcando diferencias, el sillón de barbero vintage que despierta pasiones.

FR_ Faisant la différence, le fauteuil barbier vintage éveille des passions.



68 cm

54 - 74 cm

Vintage pump cover painted in white
Embellecedor de bomba vintage lacado blanco
Enjoliveur de pompe vintage laqué blanc

119-150 cm



95 - 110 cm

Ø 68 cm

Pump loading capacity up to 300 kg
Bomba con capacidad de carga hasta 300 kg
Pompe avec capacité de charge jusqu'à 300 kg





BARBER
SHOP
FRESH S

Joey

Barber chair · Sillón de barbero · Fauteuil barbier

ENG_ A great barber chair for a perfect begining.

ES_ Un gran sillón de barbero para un inicio perfecto.

FR_ Un grand fauteuil barbier pour un grand début.

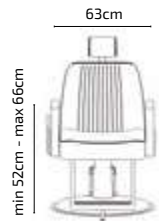

110-130cm



Pump loading capacity up to 200 kg
Bomba con capacidad de carga hasta 200 kg
Pompe avec capacité de charge jusqu'à 200 kg



Footrest with stabilizing foot
Reposapiés con soporte anti-vuelco
Repose-pieds avec pied stabilisateur



Pol

Barber Pole · Poste de barbero · Enseigne de barbier

ENG_ Classic and original. The symbol of a passion.

ES_ Clásico y original. El símbolo de una pasión.

FR_ Classique et original. Le symbole d'une passion.



Galvanized finish for outdoors
Acabado galvanizado para exteriores
Revêtement galvanisé pour extérieurs

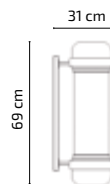

Karl

Barber chair · Sillón de barbero · Fauteuil barbier

ENG_ A wise choice for those who want to stand out.

ES_ Sabia elección. Sillón de barbero clásico para destacar.

FR_ Le choix idéal. Fauteuil barbier classique pour les meilleurs.

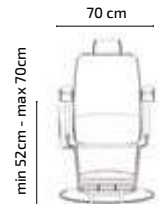

110-150 cm



Ø 68cm

Pump loading capacity up to 200 kg
Bomba con capacidad de carga hasta 200 kg
Pompe avec capacité de charge jusqu'à 200 kg

Die-cast aluminium armrests
Brazos dealuminio fundido
Accoudoirs en aluminium coulé



BARBERSHOP
HAIR CUT & SHAVES



Prince

Barber chair · Sillón de barbero · Fauteuil barbier

ENG_ A noble barber chair for those with a wild side. Barber chair that transcends the limitations.

ES_ Para despertar el lado más rebelde. Sillón que trasciende las normas.

FR_ Pour éveiller le côté plus rebelle et se sentir libre. Le fauteuil barbier qui enfreint les normes.

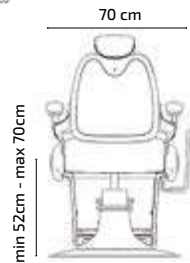

110-150 cm

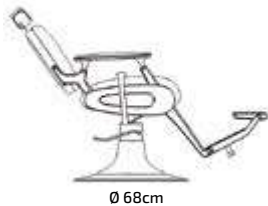

Ø 68cm

Pump loading capacity up to 300 kg
Bomba con capacidad de carga hasta 300 kg
Pompe avec capacité de charge jusqu'à 300 kg

Black pump cover
Embellecedor de bomba negro
Enjoliveur de pompe noir



Die-cast aluminium structure
Estructura de aluminio fundido
Structure en aluminium coulé





*“A strong spirit
transcends rules”*

Prince

Silvia B

Barber chair · Sillón de barbero · Fauteuil barbier

ENG_ Practical and functional stability that makes a difference.

ES_ Estabilidad que marca la diferencia. Práctica y funcional que no deja indiferente.

FR_ Sa stabilité fait la différence. Pratique et fonctionnel qui ne laisse pas indifférent.

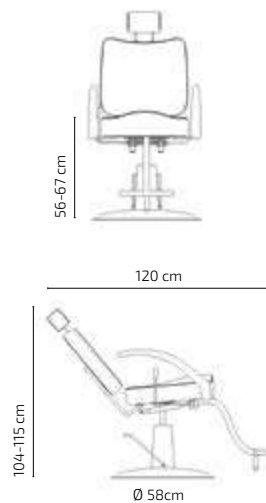

Removable head-rest
Reposacabezas extraíble
Repose-tête extractible



Reinforced structure
Estructura reforzada
Structure renforcée

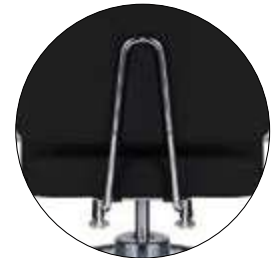

300 N double gas spring
Doble pistón de gas de 300N
cada uno
Double vérin à gaz de 300N
chacun



Footrest with stabilizing foot
Reposapiés con soporte antivuelco
Repose-pieds avec pied stabilisateur

Catty

Vaccum cleaner · Aspirador · Vacuum

ENG_ The ideal cleaning solution, quick and comfortable for a tidy workspace.

ES_ La solución de limpieza ideal, rápida y cómoda para tener el espacio impecable.

FR_ La solution de nettoyage idéale, rapide et confortable pour un espace impeccable.

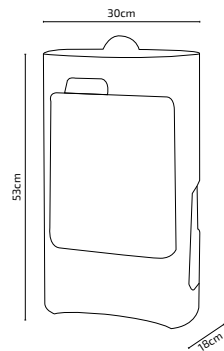

Infrared sensors
Sensores infrarojos
Capteurs infrarouges

Powerful 1400w motor
Motor de 1400w de potencia
Moteur puissant de 1400w



Automatic and manual modes and LED status indicator
Interruptor de modo automático, manual o apagado e indicador de estado LED
Interrupteurs de mode automatique, manuel et arrêt; indicateur d'état



High density filter
Filtro de alta densidad
Filtre haute densité



Millie

Anti-fatigue mat · Alfombra antifatiga · Tapis anti-fatigue

ENG_ Semicircular gel mat for comfortable feet and good posture.

ES_ Alfombra antifatiga de forma semicircular. Previene el dolor y promueve una buena postura.

FR_ Tapis anti-fatigue de forme ovale. Préviens les douleurs et favorise une bonne posture.

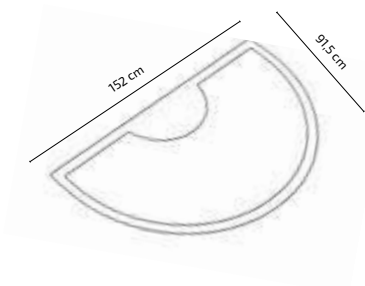

Hard surface
Superficie dura
Surface rigide

Layla

Anti-fatigue mat · Alfombra antifatiga · Tapis anti-fatigue

ENG_ Rectangle gel mat for comfortable feet and good posture.

ES_ Alfombra antifatiga de forma rectangular. Previene el dolor y promueve una buena postura.

FR_ Tapis anti-fatigue de forme carrée. Préviens les douleurs et favorise une bonne posture.

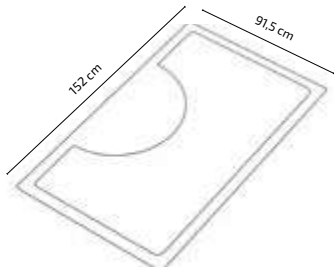

Special space for placing the base of the chairs to properly hold the gel mat

Espacio para alojar la base de las sillas fijando la alfombra completamente

Espace pour placer la base des fauteuils pour que le tapis soit complètement fixe



Styling chairs

Sillones de corte

Fauteuils de coupe

Mirplay bases



ENG_ Bases are supplied separately and are carefully packed to minimize risks during transportation.

ES_ Las bases se suministran por separado y son cuidadosamente empaquetadas para minimizar riesgos durante el transporte.

FR_ Les bases sont fournies séparément et sont soigneusement emballées pour minimiser les risques pendant le transport.

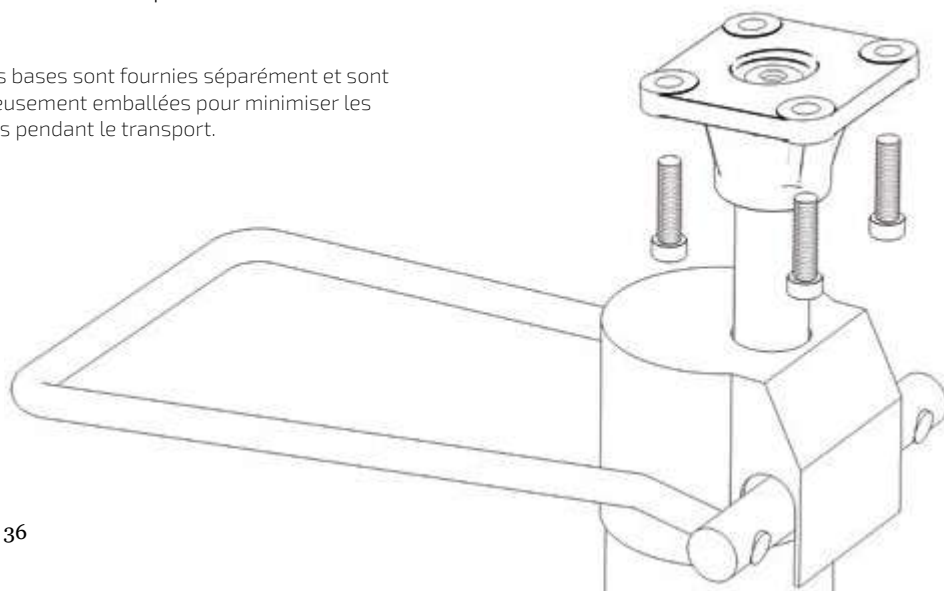

Choose your base



ENG_ Die-cast aluminum socket mechanized by CNC for a perfect fit to the cylinder. With a 4% inclination for a greater comfort.

ES_ Conector de aluminio fundido, mecanizado en CNC, para que ajuste perfectamente al cilindro. Con un 4 % de inclinación para dar una mayor comodidad.

FR_ Platine en aluminium coulé et mécanisé par usinage CNC pour une adaptation parfaite au cylindre. 4% d'inclinaison pour un plus de confort.



ENG_ Pump with a 200 kg loading capacity and regulation of the self-adjustment break.

ES_ Bomba con capacidad de carga hasta 200 kg, y regulación de autoajuste de frenado.

FR_ Pompe avec une capacité de charge de 200 kg et réglage de l'auto-ajustement du frein.



○ / **ROUNDED (R)**

Round stainless steel base with pump
Base redonda en acero inoxidable con bomba
 Base ronde en acier inoxydable avec pompe



Ø 50cm

□ / **SQUARE (S)**

Square stainless steel base with pump
Base cuadrada en acero inoxidable con bomba
 Base carrée en acier inoxydable avec pompe



50x50cm

☆ / **FIVE STAR (F)**

5 star aluminum base with pump
Base estrella 5 aspas en aluminio con bomba
 Base étoile 5 branches en aluminium avec pompe



Ø 66cm

★ / **FIVE STAR BLACK (FB)**

5 star aluminum base with pump painted in black
Base estrella 5 aspas en aluminio con bomba de color negro
 Base étoile 5 branches en aluminium avec pompe, peintes en noir



Ø 66cm

Ocean

Styling chair · Sillón de corte · Fauteuil de coupe

ENG_ A perfect balance between a classic style and nature.

ES_ Equilibrio perfecto entre la sensibilidad y el cuidado de lo natural.

FR_ L'équilibre parfait entre sensibilité et soin naturel.



Base:

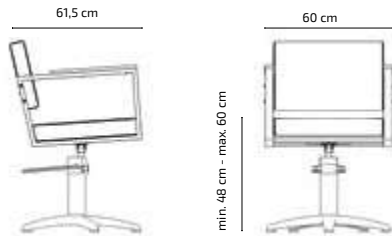

Black painted metal structure
Estructura metálica pintada en negro
Structure métallique peinte en noir

Black painted base and pump
Base y bomba de color negro
Base et pompe peintes en noir

Solid oak wood armrest
Reposabrazos en madera de roble macizo
Accoudoirs en bois massif de chêne



The most avant-garde minimalism

Gold piping
Costura en acabado dorado
Bordure en finition dorée



Dora

Styling chair · Sillón de corte · Fauteuil de coupe

ENG_ Elegant and contemporary.
A popular chair in many salons.

ES_ Elegante, sobria y
contemporánea. Despierta
pasiones en muchos salones.

FR_ Le fauteuil de coiffure
élégant, sobre et contemporain
qui éveille des sentiments dans
beaucoup de salons.



Base:

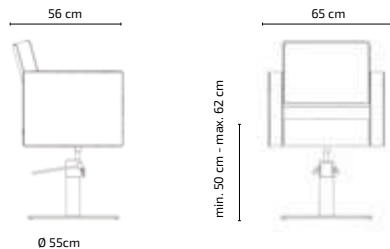



Chloe

Styling chair · Sillón de corte · Fauteuil de coupe

ENG_ Inevitable attraction
an elegant style with a
contemporary design.

ES_ Atracción inevitable, de estilo
vanguardista con un diseño
elegante y persistente.

FR_ Attraction inévitable, de style
avant-gardiste avec un design
élégant et persistant.

Base:

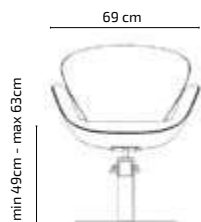

Metallic inner structure
Estructura interior metálica
Structure intérieure métallique

High-density injected PU foam
Espuma de PU inyectado de alta densidad
Mousse de PU injecté de haute densité



Chloe



Chloe W



Chloe G



Chloe R



Chloe BL





Freya

Styling chair · Sillón de corte · Fauteuil de coupe

ENG_ Simplicity and elegance. Chair that offers comfort and resistance with style.

ES_ Sencillez y elegancia. Sillón que aporta confort y resistencia con estilo.

FR_ Simplicité et élégance. Fauteuil de coiffure qui apportera confort et résistance avec un style propre.



Reinforced seat and backrest joint
Unión reforzada entre respaldo y asiento

Union renforcée entre l'assise et le dossier.

Chromed base
Base cromada
Base chromée

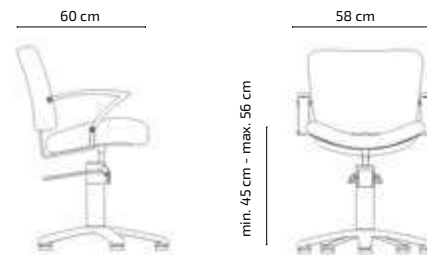

Molly

Styling chair · Sillón de corte · Fauteuil de coupe

ENG_ Ideal for beginnings. Chair for brave and daring entrepreneurs.

ES_ Ideal para los inicios. Sillón para emprendedores valientes y atrevidos.

FR_ Idéal pour les débuts. Le fauteuil de coiffure des entrepreneurs courageux et audacieux.



Let's get started



Lifting by gas lift stem
Elevación mediante pistón de gas
Élévation par vérin à gaz



Injected PU armrest
Brazos de PU inyectado
Accoudoirs en PU injecté

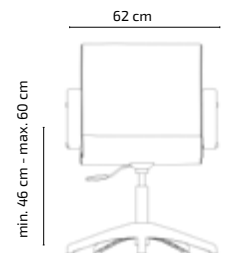

Loris

Styling chair · Sillón de corte · Fauteuil de coupe

ENG_ The glamour's essence,
designed to be agile and
versatile.

ES_ La esencia del glamour,
diseñada para ser ágil y
versátil.

FR_ L'essence du glamour.
Conçue pour être agile et
polyvalente.



Base:

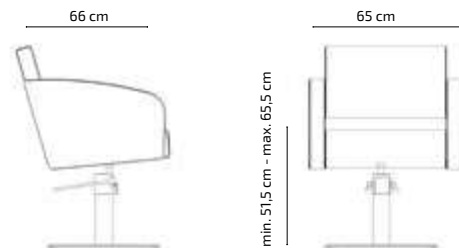



Fashion goes by, style remains

Bertie

Styling chair · Sillón de corte · Fauteuil de coupe

ENG_ Balanced design that looks and feels good.

ES_ Diseño equilibrado con estilo propio que sienta bien.

FR_ Design équilibré avec style propre pour sentir à l'aise.

Metallic inner structure
Estructura interior metálica
Structure intérieure métallique

Chromed base
Base cromada
Base chromée



Ø 55cm



min. 44 cm - max. 56 cm



Fandy

Styling chair · Sillón de corte · Fauteuil de coupe

ENG_ Demanding and sturdy with stainless steel details. For meticulous craftsman.

ES_ Exigente y robusta con detalles de acero inoxidable. Para artesanos detallistas.

FR_ Exigeante et robuste avec des détails en acier inoxydable. Pour artisans minutieux.



Base:

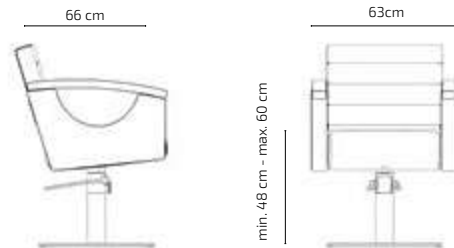

Stainless steel armrest
Brazos de acero inoxidable
Accoudoirs en acier inoxydable



Horace

Styling chair · Sillón de corte · Fauteuil de coupe

ENG_ Cubist, sensitive and elegant design that lasts through time.

ES_ Diseño cubista, sensible y elegante que perdura en el tiempo.

FR_ Design cubiste, sensible et élégant qui perdure dans le temps.



Chromed base
Base cromada
Base chromée

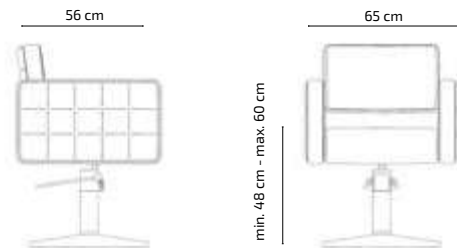

A modern hair salon interior featuring black leather chairs, white washbasins, and a wall with a quote. The room has a rustic, textured wall and a ceiling with dark wooden slats. A hanging plant is visible on the left wall. The floor is made of light-colored wood.

"You are so square, baby
I don't care"
Elvis Presley



Petra

Styling chair · Sillón de corte · Fauteuil de coupe

ENG_ Avant-garde design for the perfectionist.

ES_ Diseño vanguardista para los más perfeccionistas.

FR_ Conception novatrice pour les plus perfectionnistes.

Base:



Metallic inner structure
Estructura interior metálica
Structure intérieure métallique

High-density injected PU foam
Espuma de PU de alta densidad inyectada
Mousse de PU injecté de haute densité

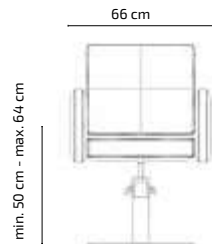

In good shape



Gat

Styling chair · Sillón de corte · Fauteuil de coupe

ENG_ Designed for the amusement of the little ones.

ES_ Creado para el disfrute de los más pequeños.

FR_ Créé pour le plaisir des plus petits.



Height adjustable by gas lift stem
Elevación mediante pistón de gas
Hauteur réglable par vérin à gaz

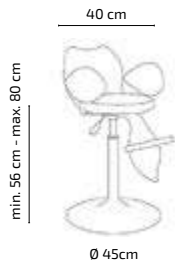

Safety belt
Cinturón de seguridad
Ceinture de sécurité

Brenda

Styling chair cover · Funda para sillón de corte ·
Housses pour fauteuils de coupe

ENG_ Protect your chairs with our covers.

ES_ Protege tus sillas con nuestras fundas.

FR_ Protégez vos fauteuils avec nos housses.



Brenda1_ Horace · Dora · Freya

Brenda2_ Loris · Fandy · Molly

Brenda3_ Petra · Ocean



Jilly

Seat booster · Alzador de asiento · Réhausseur

ENG_ So youngsters can feel like adults.

ES_ Para que los más pequeños se sientan grandes.

FR_ Pour que les plus petits se sentent comme des adultes.

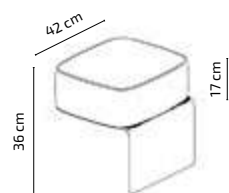

Shampoo units

Lavacabezas

Bacs à shampoing

BASIN · CERÁMICA · VASQUE

/ ROUNDY_

Ceramic · Cerámica · céramique



Jacob · Basil · Marvin



/ LARGUY_

Ceramic · Cerámica · céramique



Ralph · Thomas · Peter



/ COMFY_

Ceramic · Cerámica · céramique



Charly

/ EASY_

Polypropylene · Polipropileno · Polypropylène



Oliver

black or white?



Charly

Shampoo units · Lavacabezas · Bacs à shampoing

ENG_ The evolution of the ergonomic shampoo unit. Freshness and passion. Designed to stand out and manufactured to be enjoyed.

ES_ La evolución del lavacabezas ergonómico. Frescura y pasión. Diseñado para destacar y creado para disfrutarlo.

FR_ L'évolution du bac à shampoing ergonomique. Fraîcheur et passion. Conçu pour briller et fabriqué pour en jouir.



PATENT PENDING

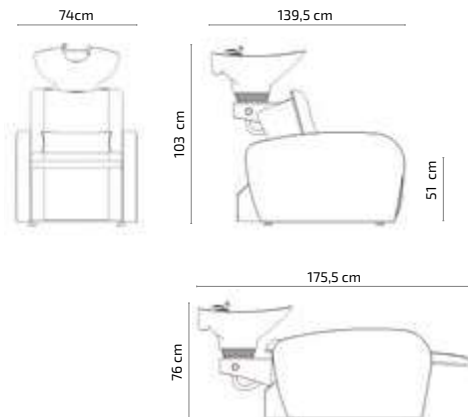

Synchronized reclining basin and backrest
Respaldo y cerámica reclinable conjuntamente
Dossier et vasque inclinables conjointement

Additional cushion
Cojín adicional
Coussin additionnel

Electric footrest
Reposapiés eléctrico
Repose-pieds électrique





DIVINE
HAIR SALON

*When ergonomics is
a priority*



Reclining backrest and basin, ideal for working while seated

Respaldo y cerámica reclinable, ideal para trabajar sentado

Dossier et vasque inclinables, pour travailler assis



MOTOR 1_ Footrest
MOTOR 1_ Reposapiés
MOTEUR 1_ Repose-pièds

MOTOR 2_ Backrest
MOTOR 2_ Respaldo
MOTEUR 2_ Dossier



Vertically and horizontally adjustable tilting ceramic basin

Cerámica basculante ajustable vertical y horizontalmente

Vasque basculante ajustable vertical et horizontalement



Basil

Shampoo units · Lavacabezas · Bacs à shampoing

ENG_ A perfect balance between a classic style and nature.

ES_ Equilibrio perfecto entre la sensibilidad y el cuidado de lo natural.

FR_ Équilibré parfait entre sensibilité et le soin naturel.



Galvanic painted metallic structure
Estructura metálica galvanizada y pintada
Structure métallique galvanisé et peinte

Ergonomic seat and backrest
Asiento y respaldo ergonómicos
Assise et dossier ergonomiques

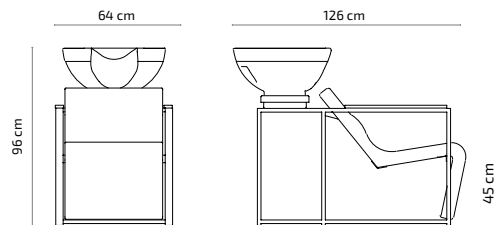

The nature of a good wash



Acrylic water stopper panel
Panel acrílico resistente al agua
Panneau acrylique résistant à l'eau

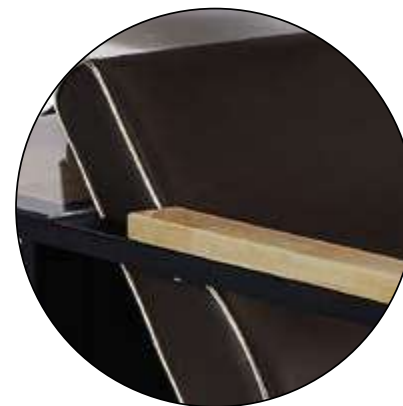

Solid oak wood
Madera de roble maciza
Bois de chêne massif

Gold piping
Ribete dorada
Bordure dorée



Thomas

Shampoo unit · Lavacabezas · Bac à shampoing

ENG_ Well balanced and compact shampoo unit with light lines.

ES_ Lavacabezas equilibrado y compacto. De líneas ligeras y adaptable.

FR_ Bac à shampoing équilibré et compact. De lignes légères et adaptable.

Water-resistant fibber glass structure
Estructura de fibra de vidrio resistente al agua
Structure de fibre de verre résistante à l'eau.

Chromed metallic armrests
Brazos metálicos cromados
Accoudoirs métalliques chromés

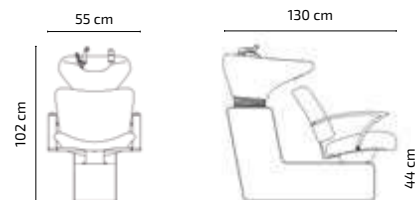



Marvin

Shampoo units · Lavacabezas · Bacs à shampoing

ENG_ Cubist, sensitive and elegant design that lasts through time.

ES_ Diseño cubista, sensible y elegante que perdura en el tiempo.

FR_ Design cubiste, sensible et élégant qui perdure dans le temps.



Stainless steel basin support cover
Acabados en acero inoxidable
Support en acier inoxydable

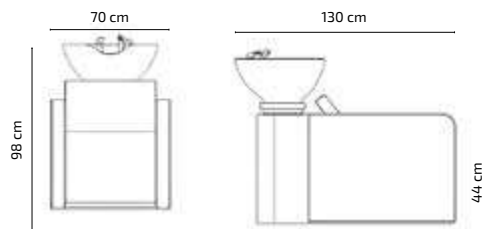



Ralph

Shampoo units · Lavacabezas · Bacs à shampoing

ENG_ Freshness and passion.
Classy shampoo unit. Rest and relax at the touch of a button.

ES_ Frescura y pasión.
Lavacabezas con clase.
Descanso y relax con solo pulsar un botón.

FR_ Fraîcheur et passion. Bac à shampoing avec classe. Repos et détente grâce à un simple appui de bouton.



Ergonomic seat and backrest
Asiento y respaldo ergonómicos
Assise et dossier ergonomiques



Electric footrest
Reposapiés eléctrico
Repose-pieds électrique

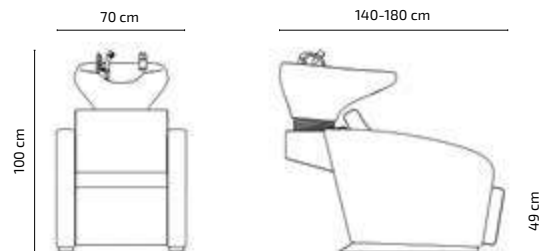

Stainless steel trim
Acabados en acero inoxidable
Enjoliveur en acier inoxydable





Peter

Shampoo units · Lavacabezas · Bacs à shampooing

ENG_ It's dimensions strengthens the design and quality. A small shampoo unit to feel great.

ES_ La dimensión refuerza su diseño y calidad. Un lavacabezas pequeño para sentirse grande.

FR_ La dimension renforce son design et sa qualité. Un petit lave-tête pour se sentir grand.

Metallic inner structure
Estructura metálica interior
Structure métallique intérieure

Ergonomic seat and backrest
Asiento y respaldo ergonómicos
Assise et dossier ergonomiques

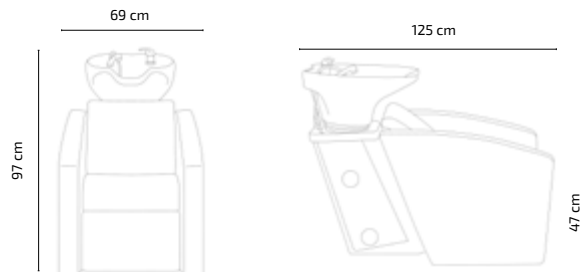

Lee • Cole

Portable shampoo bowl • Lavacabezas portátil • Bacs à shampoing portables

ENG_ Versatile, comfortable and light. Ready to be used whenever and wherever.

ES_ Versátil, cómodo y ligero. Listo para usar cuándo y dónde sea.

FR_ Polyvalent, confortable et léger. Prêt à être utilisé ou et quand que ce soit.



Lee

ABS height adjustable and reclining basin
Cerámica de ABS de altura ajustable
Vasque en ABS à hauteur réglable



Cole



Jacob

Shampoo units · Lavacabezas · Bacs à shampoing

ENG_ Ergonomic in a contemporary design. Elegant style that adds character.

ES_ Ergonomía en un diseño contemporáneo. Estilo elegante que aporta carácter.

FR_ Ergonomie dans un design contemporain. Style élégant qui apporte du caractère.



Ergonomic seat
Asiento ergonómico
Assise ergonomique

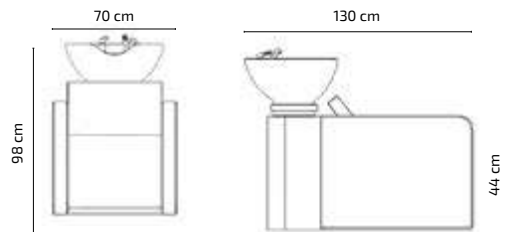

Fibber glass storage shelve
Espacio para almacenar en fibra de vidrio
Meuble de rangement en fibre de verre





Jacob

A & B & C

Combine them as you want to create your own space

Combínalos como quieras para crear tu propio espacio

Combinez-les à votre guise pour créer votre propre espace



A

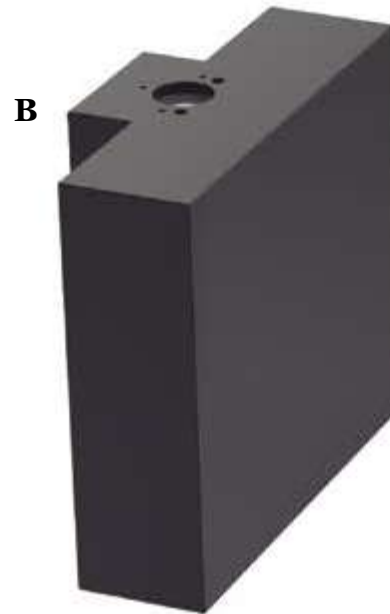

B



C





A & C

Oliver

Shampoo units · Lavacabezas · Bacs à shampoo

ENG_ Ideal in the beginning, easy and comfortable. Easy-going.

ES_ Ideal para los incios, fácil y cómodo. Sin complicaciones.

FR_ Idéal pour les débuts, facile et confortable. Sans complications.

Complete polypropylene water-resistant structure
Estructura completa de polipropileno resistente al agua
Structure complète de polypropylène résistante à l'eau

Injected PU armrests
Brazos en PU inyectado
Accoudoirs en PU injecté

Ergonomic seat
Asiento ergonómico
Assise ergonomique

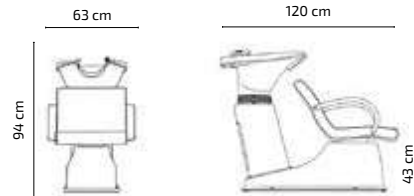



Buddy

Lumbar cushion · Respaldo lumbar · Coussin lombaire

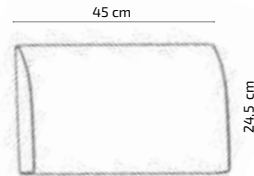

Accessories designed to provide great comfort to customers

Complementos diseñados para ofrecer un gran confort al cliente

Compléments conçus pour offrir un gran confort au client

Rex

Neck protector · Protector de cuello · Protège-cou

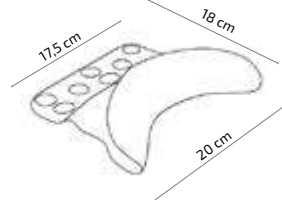

Den

Neck protector · Protector de cuello · Protège-cou

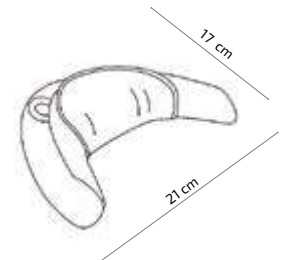



Joker

Footrest · Reposapiés · Reponse-pieds

ENG_ The perfect ally during hair wash.

ES_ El aliado perfecto durante el lavado.

FR_ Le parfait allié pendant les lavages.

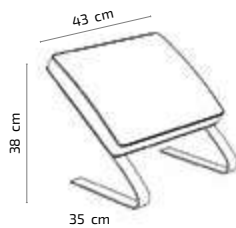

Bonnie

Booster seat · Alzador de asiento · Réhausseur

ENG_ Seat booster for shampoo units.

ES_ Cojín alzador para lavacabezas.

FR_ Réhausseur de bac à shampooing.

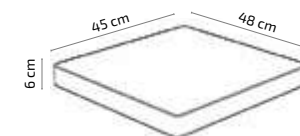



Styling units

Tocadores

Coiffeuses

Jules

Styling units · Tocadores · Coiffeuses

ENG_ Elegant, classy and complete.
Its attractive design turns it into the most desirable unit.

ES_ Elegante, con clase y completo.
Su atractivo diseño lo convierte en el más deseado.

FR_ Élégante, stylé et complète.
Son design attractif en font la plus souhaité.

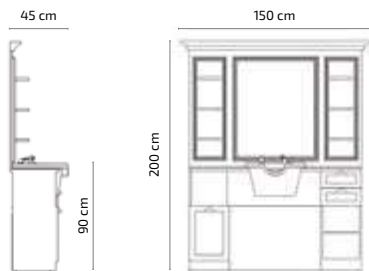

Frontal ceramic basin
Cerámica frontal
Vasque frontale en céramique

.....
Glass water stopper pannel
Cristal protector resistente al agua
Panneau en verre résistant à l'eau



Varnished solid Wood trim
Moldura de madera maciza barnizada
Molure en bois massif verni



Panel with varnished Wood veneer
Panel de madera barnizada
Panneau en bois verni





Bobbie

Styling units · Tocadores · Coiffeuses



Bobbie W

Reinforced footrest
Reposapiés reforzado
Repose-pieds renforcé



Bobbie B

Stainless steel tray and footrest
Bandeja y reposapiés de acero inoxidable
Tablette et repose-pieds en acier inoxydable

ENG_ Attractive complete styling unit with a fine minimalist design.

ES_ Atractivo tocador completo con un fino diseño minimalista.

FR_ Séduisante coiffeuse avec un design fin et minimaliste.

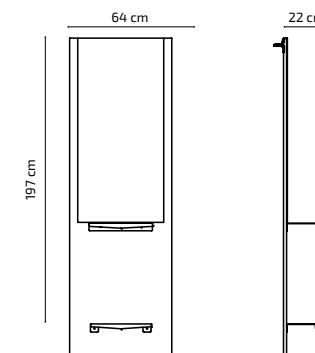

Richard

Styling units · Tocadores · Coiffeuses

ENG_ Sturdy and solid.
Combination of natural materials to obtain an industrial style.

ES_ Robusto y sólido.
Combinación de materiales nobles para obtener un estilo indomable.

FR_ Robuste et solide.
Combinaison de matériels nobles pour obtenir un style indomptable.

Hand-finished to create beautiful and unique imperfections

Acabados a mano para crear bellas y únicas imperfecciones

Finitions à la main pour créer de belles et uniques imperfections



Tray with shelf and 2 hooks
Bandeja con estante y 2 ganchos
Plateau garde-objets avec 2 crochets

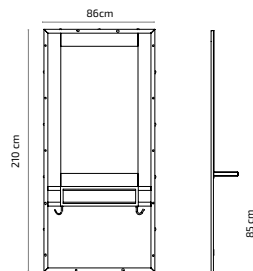

Patrick

Styling units · Tocadores · Coiffeuses



Stainless steel tray and frame
Bandeja y marco de acero
inoxidable
Tablette et cadre en acier
inoxydable

Patrick W



Patrick B

ENG_ Reflects the art. Expert styling unit with distinguished style.

ES_ Refleja el arte. Experto tocador de peluquería de estilo distinguido.

FR_ Reflète l'art. Coiffeuse experte de style distingué.

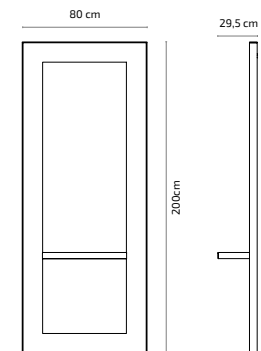

Robin

Styling units · Tocadores · Coiffeuses

ENG_ Love at first sight. A perfect balance between a classic style and nature.

ES_ Amor a primera vista, equilibrio perfecto entre la sensibilidad y el cuidado de lo natural.

FR_ Amour à première vue, équilibre parfait entre la sensibilité et le soin naturel.

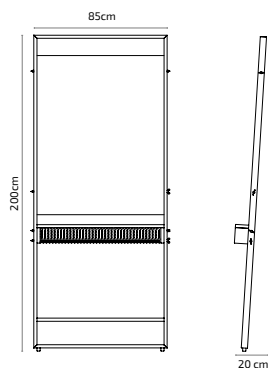

LED light
Luz LED
Éclairage LED

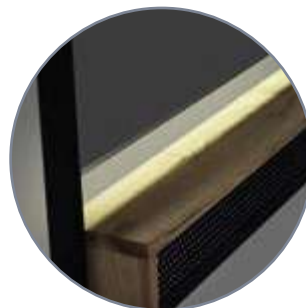

Solid wood and metal tray
Estante de madera de roble macizo con cajón metálico
Étagère en bois de chêne massif avec caisson métallique

Golden stainless steel footrest
Reposapiés dorado de acero inoxidable
Repose-pieds doré en acier inoxydable



Zoel

Styling units · Tocadores · Coiffeuses

ENG_ Distinguished curves that bring unique elegance and style. Modern styling unit that makes a difference.

ES_ Curvas distinguidas que aportan un estilo y elegancia únicos. Tocador moderno que marca la diferencia.

FR_ Courbes distingués qui apportent un style et élégance uniques. Coiffeuse moderne qui fait la différence.



Stainless steel tray
Bandeja de acero inoxidable
Tablette en acier inoxydable

Zoel W



Zoel B



Hair dryer holder protected with a rubber ring
Soporte para secador con protector de silicona
Porte sèche-cheveux avec protection en caoutchouc

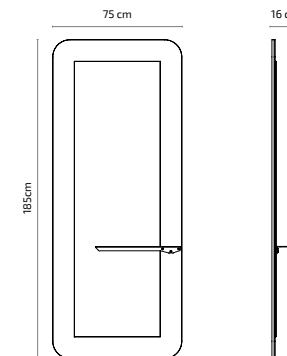

Roger B

Styling units · Tocadores · Coiffeuses

ENG_ Skillfully upholstered unit with a personality to make the salon shine.

ES_ Tapizado con arte. Personalidad y carácter, ilumina para hacer brillar.

FR_ Tapissé avec de l'art. Personnalité et caractère. Illumine pour faire briller.



LED light
Luz LED
Éclairage LED



Wooden frame upholstered in synthetic leather
Marco de madera tapizado en polipiel
Cadre en bois garni en simili-cuir



Reinforced white acrylic tray
Bandeja reforzada de acrílico blanco
Tablette renforcée en acrylique blanc

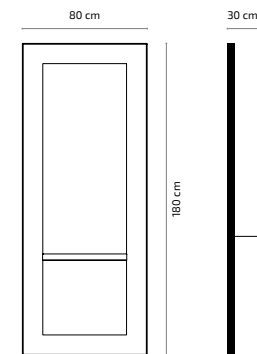

Poppy B

Styling units · Tocadores · Coiffeuses

ENG_ Reflects passion, precision and creativity. Lights up the best of works.

ES_ Refleja la pasión, la precisión y la creatividad. Retroilumina los mejores trabajos.

FR_ Reflète la passion, la précision et la créativité. Retroillumine les meilleurs travaux.

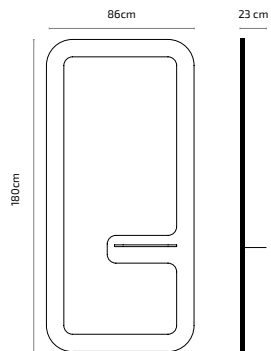

Styling unit with lacquered black silhouette
Espejo con silueta lacada en negro
Miroir avec silhouette laquée noir

Book line LED illumination
Iluminación LED perimetral posterior
Éclairage LED périmétral postérieur

Reinforced white acrylic tray with hair dryer holder
Bandeja reforzada de acrílico blanco con soporte para secador
Tablette renforcée en acrylique blanc avec porte sèche-cheveux





Dryer holders · Porta secadores · Porte-séchoirs

/ Chris

ENG_ Metal hair dryer holder with protective rubber ring.

ES_ Porta secador metálico con goma protectora.

FR_ Porte-séchoir métallique avec anneau protecteur en caoutchouc.



/ Jan

ENG_ Die-cast aluminum hair dryer holder.

ES_ Porta secador de aluminio inyectado.

FR_ Porte-séchoir en aluminium.



Footrest · Reposapiés · Reponse-pieds

ENG_ Stainless steel footrests that make hair cutting a wonderful experience.

ES_ Reposapiés de acero inoxidable, que hacen del corte de pelo una experiencia placentera.

FR_ Reponse-pieds en acier inoxydable qui font de la coupe de cheveux une expérience agréable.

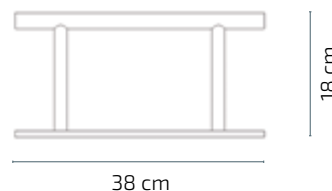

Troy



Dan



Todd



Mack





Stools

Taburetes

Tabourets

Twins

Stool · Taburete · Tabouret

ENG_ Two better than one. The twin stools with attitude.

ES_ Dos mejor que uno. Los taburetes gemelos con carácter.

FR_ À deux, c'est mieux. Les tabourets jumeaux avec caractère.



Silent and soft polyurethane wheels with anti-hair system

Ruedas de poliuretano ligeras y silenciosas con sistema antipelo

Roulettes en polyuréthane, douces et silencieuses avec système anti-cheveux



Glossy finish padded seat

Asiento acolchado con acabado brillante

Assise rembourrée avec finition brillante



Gorgeous

Ergonomic saddle stool. Gas spring height adjustable seat

Asiento con forma ergonómica y regulable en altura mediante pistón de gas

Assise avec forme ergonomique et réglable en hauteur par vérin à gaz



Gordon

Stool · Taburete · Tabouret

ENG_ The magnificent combination between movement and comfort.

ES_ La magnífica combinación entre el movimiento y la comodidad.

FR_ La combinaison parfaite entre mouvements et bien-être.



Silent and soft polyurethane wheels with anti-hair system

Ruedas de poliuretano suaves y silenciosas con sistema antipelo

Roulettes en polyuréthane, douces et silencieuses avec système anti-cheveux



Stool with backrest and gas lift height adjustable seat

Taburete con respaldo, ajustable en altura mediante pistón de gas

Tabouret avec dossier et assise réglable en hauteur par vérin à gaz

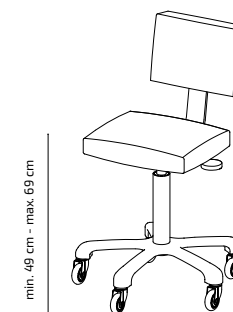

min. 49 cm - max. 69 cm

Ø 66 cm



Ian

Stool · Taburete · Tabouret

ENG_ Its ergonomic design allows a correct posture. Keeping up with the long working sessions has never been so comfortable.

ES_ Su diseño ergonómico permite mantener una postura correcta. Seguir el ritmo de largas jornadas no había sido nunca tan cómodo.

FR_ Son design ergonomique permet de maintenir une bonne posture. Supporter le rythme des longues journées n'a jamais été si confortable.

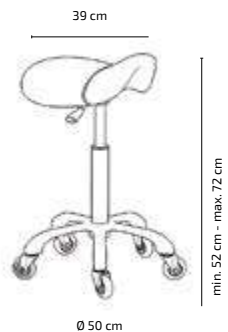

Gas lift height adjustable seat.
Asiento ergonómico y ajustable en altura mediante pistón de gas
Assise ergonomique et réglable en hauteur par vérin à gaz



Silent and soft polyurethane wheels with anti-hair system

Ruedas de poliuretano ligeras y silenciosas con sistema antipelo

Roulettes en polyuréthane, douces et silencieuses avec système anti-cheveux



Leo y Nil

Stools · Taburetes · Tabourets



Nylon base and castors
Base de nylon con ruedas
Base en nylon avec roulettes

Leo



Nil



ENG_ Rest, work and create on wheels is much more fun.

ES_ Descansar, trabajar y crear sobre ruedas es más divertido.

FR_ Se reposer, travailler et attendre sur des roulettes est toujours plus amusant.

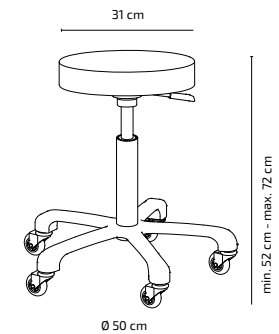

Aluminum base with silicon anti-hair castors

Base de aluminio con ruedas de poliuretano antipelo

Base en aluminium avec roulettes de silicone anti-cheveux



Trolleys and accessories

Carros y complementos

Chariots et compléments

Wally

Shelving · Estantería · Étagère

ENG_ Wall display shelve.
Combination of natural materials to
obtain an industrial style.

ES_ Expositor con energía.
Combinación de materiales nobles
para obtener un estilo indomable.

FR_ Présentoir avec énergie.
Combinaison de matériels nobles
pour obtenir un style indomptable.

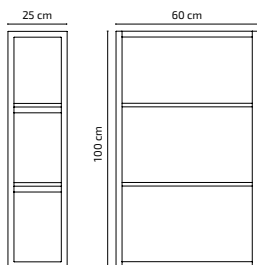

Noah

Shelving · Mueble estantería · Meuble étagère

ENG_ To display products and arise emotions. Combination of natural materials to obtain an industrial style.

ES_ Para exponer productos y despertar emociones. Combinación de materiales nobles para obtener un estilo indomable.

FR_ Pour présenter des produits et éveiller des émotions. Combinaison de matériaux nobles pour obtenir un style indomptable.

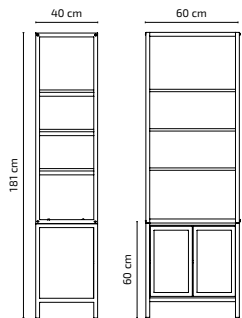

Vintage metal structure display unit with wooden shelves

Estantería metálica vintage con estantes de madera

Meuble métallique vintage avec étagères en bois



Metallic mesh

Malla metálica

Maille métallique



Hand-finished to create beautiful and unique imperfections

Acabados a mano para crear bellas y únicas imperfecciones

Finitions à la main pour créer de belles et uniques imperfections



Alan

Trolley · Carro · Chariot

ENG_ Robust barber assistant. A combination of design and strenght.

ES_ Fornido ayudante de barbero, Combinación de materiales nobles para obtener un estilo indomable.

FR_ Costaud assistant de barbier. Combinaison de matériels nobles pour obtenir un style indomptable.

Hand-finished to create beautiful and unique imperfections

Acabados a mano para crear bellas y únicas imperfecciones

Finitions à la main pour créer de belles et uniques imperfections

Metallic mesh
Malla metálica
Maille métallique

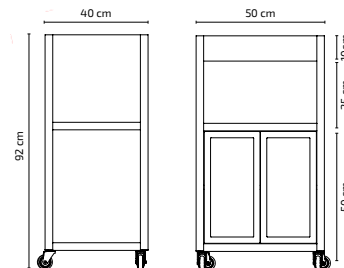

Polyurethane castors with anti hair protection. Two castors with brake

Ruedas de poliuretano antipeló, 2 de ellas con freno

Roulettes en polyuréthane anti-cheveux, 2 d'entre elles avec freins

Holly

Shelving · Estantería · Étagère

ENG_ Full of life. A perfect balance between a classic style and nature.

ES_ Llena de vida. Equilibrio perfecto entre la sensibilidad y el cuidado de lo natural.

FR_ Pleine de vie. Équilibre parfait entre la sensibilité et le soin naturel.



Solid oak wood
Madera de roble macizo
Bois de chêne massif

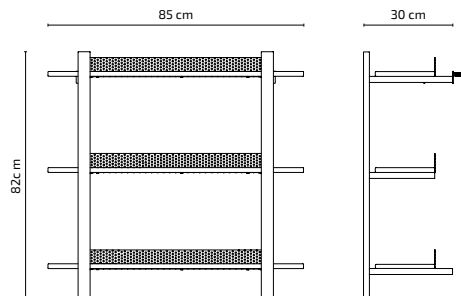

LED illumination in both metal profiles
Iluminación LED en los dos perfiles metálicos
Éclairage LED sur les deux profils métalliques



Skye

Trolley · Carro · Chariot

ENG_ A perfect balance between a classic style and nature.

ES_ Equilibrio perfecto entre la sensibilidad y el cuidado de lo natural.

FR_ Équilibre parfait entre la sensibilité et le soin naturel.

Trolley with black painted metallic structure
Carro con estructura metálica pintada en negro
Chariot avec structure métallique peinte en noir



Solid oak wood with sliding trays

Estantes móviles de madera de roble macizo

Bois massif de chêne avec plateaux déplaçables

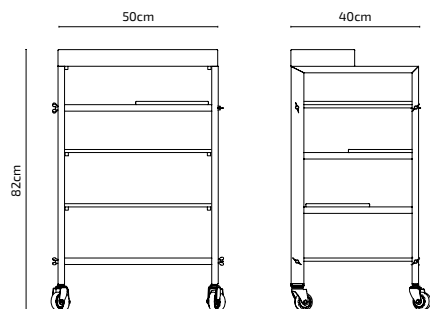

Polyurethane castors with anti hair protection. Two castors with brake

Ruedas de poliuretano antipelajo, 2 de ellas con freno

Roulettes en polyuréthane anti-cheveux, 2 d'entre elles avec freins

Golden stainless steel protector

Protector de acero inoxidable color dorado

Protecteur doré en acier inoxydable



Iris

Worktable · Mesa de trabajo · Table de travail

ENG_ To brighten the best of ideas. A perfect balance between a classic style and nature.

ES_ Para dar luz a las mejores ideas. Equilibrio perfecto entre la sensibilidad y el cuidado de lo natural.

FR_ Pour donner naissance aux meilleures idées. Équilibre parfait entre la sensibilité et la soin naturel.

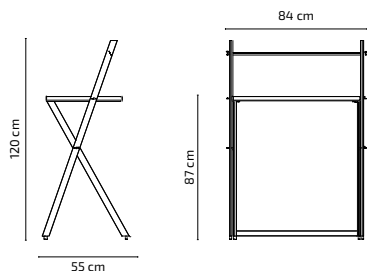

LED light
Luz LED
Éclairage LED

Solid oak wood
Madera de roble macizo
Bois de chêne massif



Golden stainless steel protector
Protector de acero inoxidable
color dorado
Protecteur doré en acier
inoxydable

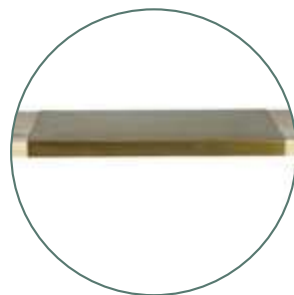

Vitus

Trolley · Carro · Chariot

ENG_ The hairdressing trolley who always have space for the precious tools.

ES_ El carro de peluquería que siempre tiene espacio para guardar valiosos utensilios.

FR_ Les chariots de coiffure sont importants pour ranger les valieux ustensiles.

Removable hair dryer ring
Soporte para secador extraíble
Porte sèche-cheveux extractible

5 removable trays
5 bandejas extraíbles
5 plateaux extractibles



Solid plastic anti hair rubber castors
Ruedas antipelo de caucho
Roulettes anti-cheveux en caoutchouc





Lenny

Trolley · Carro · Chariot

ENG_ Designed to keep up with the workflow. Versatile and agile.

ES_ Creado para seguir el ritmo de trabajo. Versátil y ágil.

FR_ Conçu pour suivre le rythme de travail. Chariot de coiffure polyvalent et agile.



Removable hair dryer ring
Soporte extraíble para secador
Porte sèche-cheveux extractible



Side shelving
Portaobjetos laterales
Garde-objets latéraux

4 Removable trays
4 bandejas extraíbles
4 plateaux extractibles

Adam

Trolley · Carro · Chariot

ENG_ The hairdressing trolley with multiple spaces to keep the precious tools.

ES_ El carro de peluquería con múltiples espacios para guardar valiosos utensilios.

FR_ Le chariot de coiffure à espaces multiples pour ranger les précieux ustensiles.

5 removable trays
5 bandejas extraíbles
5 plateaux extractibles

2 trays can be hooked to the top part
2 bandejas pueden anclarse en la parte superior
2 plateaux peuvent se fixer sur la partie supérieure

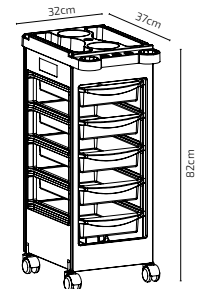

Jeff

Trolley · Carro · Chariot

ENG_ Simplicity and simpleness united to win in all spaces.

ES_ Simplicidad y sencillez unidos para ganar en todos los espacios.

FR_ Simplicité et facilité d'utilisation unis pour gagner dans tous les espaces.



Aluminum tray with non-slip silicone matt
Bandeja de aluminio con alfombra de silicona antideslizante
Plateau en aluminium avec tapis en silicone antidérapant



Height adjustable
Ajustable en altura
Réglable en hauteur

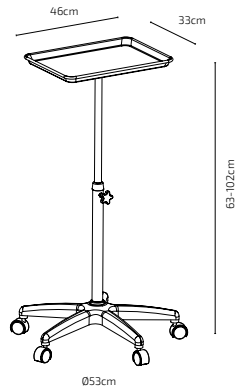

Moe

Trolley · Carro · Chariot

ENG_ The hair salon assistant that goes everywhere.

ES_ El ayudante de peluquería que va a todas partes.

FR_ Le chariot de coiffure qui va partout.



ABS tray with timer
Bandeja de ABS con temporizador
Plateau en ABS avec temporisateur



Height adjustable
Ajustable en altura
Réglable en hauteur

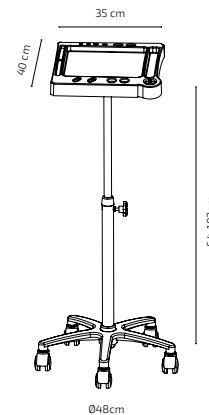



Receptions and waiting areas

Recepciones y esperas

Réceptions et salles d'attente

Floyd B

Reception · Recepción · Réception

ENG_ Versatile and elegant reception desk for displaying products in style.

ES_ Recepción versátil y elegante para exhibir productos con clase.

FR_ Comptoir de réception polyvalent et élégant pour exhiber des produits d'une manière stylé.

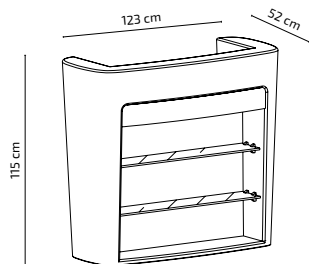

Fibber glass reception
Recepción de fibra de vidrio
Réception en fibre de verre



Acrylic front panel
Panel frontal acrílico
Panneau avant acrylique

Floyd B





Floyd W

Sliding cristal doors product storage and LED lighting display

Expositor con LED y espacio para almacenar, separado con puertas correderas de cristal

Présentoir avec éclairage LED et espace de rangement avec portes coulissantes en verre



2 USB ports, EU and UK plug supported

2 puertos USB y enchufe EU/UK

2 ports USB et prises EU/UK



Doors and drawers with lock

Puertas y cajones con llave

Portes et tiroirs avec clé

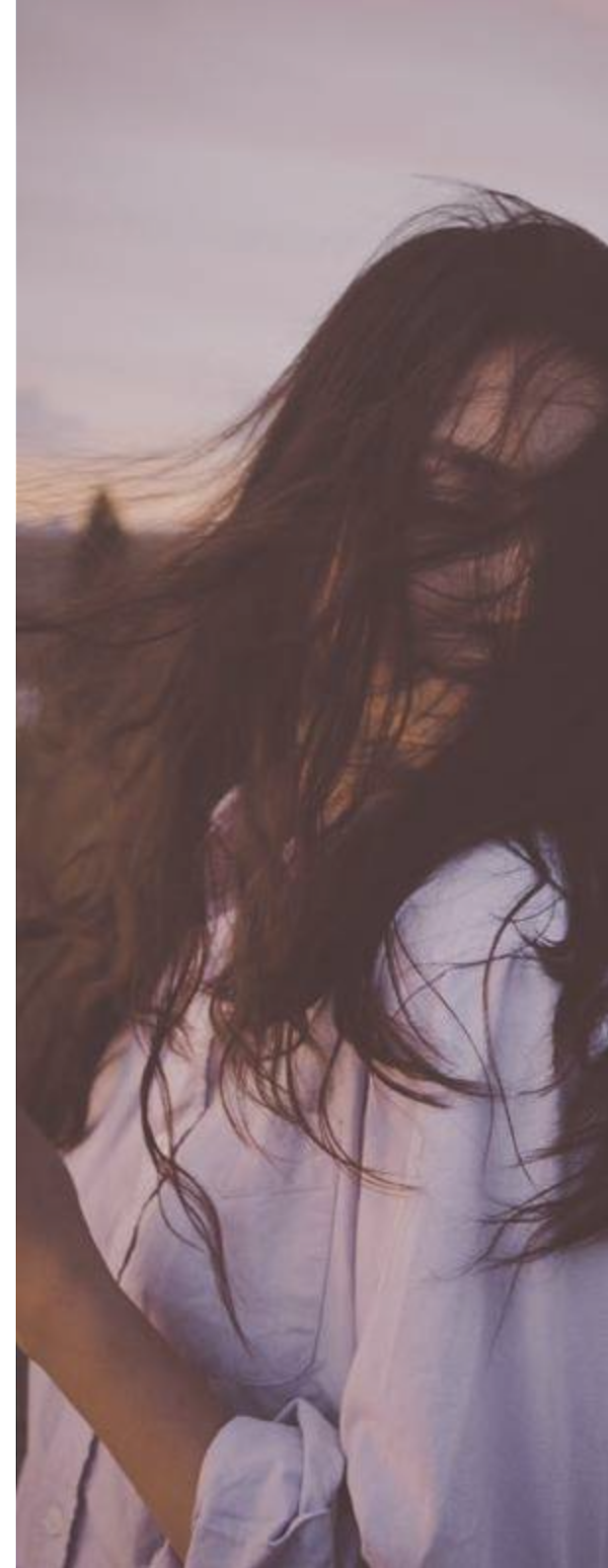

Finch

Reception · Recepción · Réception

ENG_ Seductive. A perfect balance between a classic style and nature.

ES_ Seductor. Con el equilibrio perfecto entre la sensibilidad y el cuidado de lo natural.

FR_ Séducteur. Design naturel et élégant. Fusion entre l'urbain et le rural.

Solid Oak wood, combined with black melamine

Madera de roble macizo, combinado con melamina negra

Bois en chêne massif combiné avec mélamine noire.



Lower perforated plate for storage
Espacio inferior de plancha perforada para almacenamiento
Espace inférieur en plaque perforée pour rangement

Drawers with key and lock
Cajones con cerradura y llave
Tiroirs avec serrure et clé

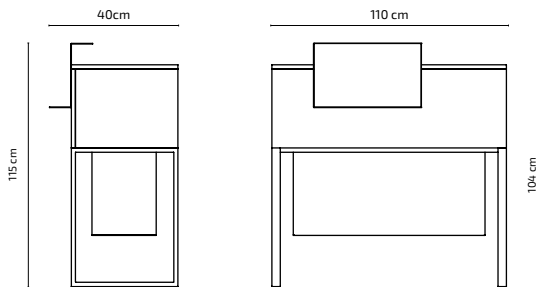



Adrian

Reception · Recepción · Réception

ENG_ Charming. Designed to stand out. Combination of natural materials to obtain an industrial style.

ES_ Cautiva y enamora. Diseñada para destacar. Combinación de materiales nobles para obtener un estilo indomable.

FR_ Captive et séduit. Conçue pour briller. Combinaison de matériels nobles pour obtenir un style indomptable.

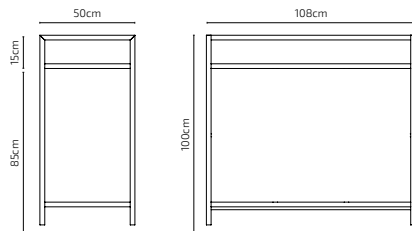

Hand-finished to create beautiful and unique imperfections

Acabados a mano para crear bellas y únicas imperfecciones

Finitions à la main pour créer de belles et uniques imperfections

Drawer with key and lock
Cajón con cerradura y llave
Tiroir avec serrure et clé



Metallic mesh
Malla metálica
Maille métallique





Dylan

Reception · Recepción · Réception

ENG_ Design and elegance for confined spaces.

ES_ Elegancia y diseño para espacios reducidos.

FR_ Élégance et design pour espaces réduits.



Grey marbled effect scratch resistant
Frontal marbreado color gris y resistente a rayadas
Marbré en gris résistant aux rayures.

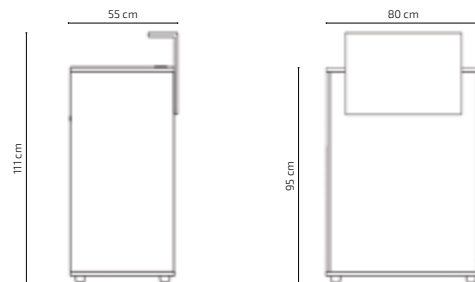

Drawer with key and lock
Cajón con cerradura y llave
Tiroir avec serrure et clé

Extendable keyboard tray
Bandeja extraíble para teclado
Plateau extractible pour clavier



Thierry

Reception · Recepción · Réception

ENG_ Minimalist design for large areas.

ES_ Diseño minimalista para espacios grandes.

FR_ Design minimaliste pour espaces grands.



OPTIONAL



Grey marbled effect scratch resistant
Frontal marbreado color gris y resistente a rayadas
Marbré en gris résistent aux rayures

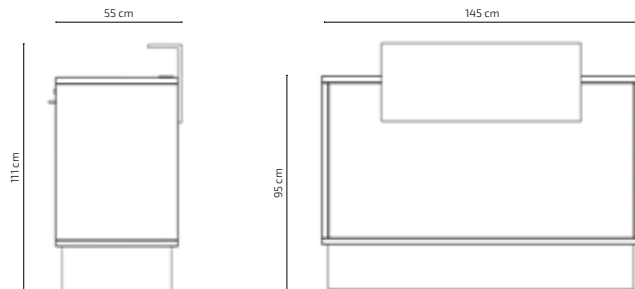

Drawer with key and lock
Cajón con cerradura y llave
Tiroir avec serrure et clé

Extendable keyboard tray
Bandeja extraíble para teclado
Plateau extractible pour clavier



Dock

Waiting area sofa · Sillón de espera · Canapé d'attente

ENG_ Distinctive and exclusive.
Admired since the XIX century.

ES_ Inconfundible y exclusivo.
Admirado desde el siglo XIX.

FR_ Unique et exclusif. Admiré depuis
le XIX siècle.

Because style matters

Wooden inner structure, covered with
high density foam

Estructura interior de madera con
espuma de alta densidad

Structure intérieure en bois avec mousse
de haute densité



Zigzag spring seat
Asiento de resorte en zigzag
Assise avec ressorts en zig zag

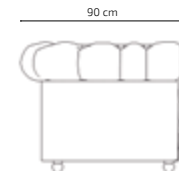
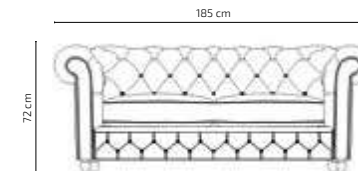



Bob, Sam & Jay

Waiting area sofa · Sillón de espera · Canapé d'attente



Bob

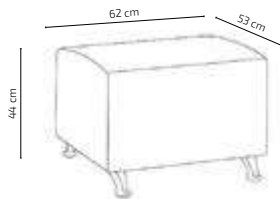

Sam

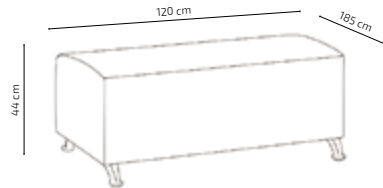

Jay

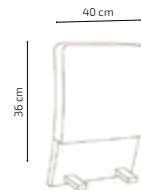

Let them wait...

ENG_ Together or separately, they are the perfect combination to relax and enjoy.

ES_ Juntos o separados, son la combinación perfecta para relajarse y disfrutar

FR_ Ensembles ou séparés, sont la combinaison parfaite pour se détendre et jouir.





Charlotte

Waiting area chair · Sillón de espera · Fauteuil d'attente

ENG_ Inspired and designed to seduce. Created for leisure spaces.

ES_ Inspirada y diseñada para seducir. Creada para espacios placenteros.

FR_ Inspirée et conçue pour séduire. Créé pour des espaces agréables.

- Ref. 1041-07
- Ref. 1041-03
- Ref. 1041-01

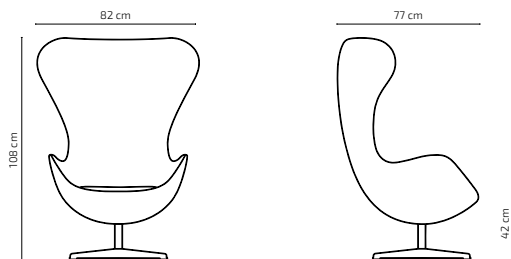

High-density Injected PU foam
Espuma de PU de alta densidad
inyectada
Mousse de PU de haute densité
injecté



Die-cast aluminum base
Base de aluminio fundido
Base en aluminium coulé





Four stars base

Waiting area chair · Sillón de espera · Fauteuil d'attente

ENG_ 4 star aluminum base.

ES_ Base estrella 4 aspas en aluminio.

FR_ Base étoile 4 branches en aluminium.

Chloe · Dora · Fandy
Petra · Loris · Ocean



Ø 66cm



Die-cast aluminum socket mechanized with CNC for a perfect fit to the cylinder. With a 4% inclination for a greater comfort.

Conector de aluminio fundido, mecanizado en CNC, para un ajuste perfecto al cilindro. Inclinación de un 4% para dar una mayor comodidad.

Platine en aluminium coulé et mécanisé par usinage CNC pour une adaptation parfaite au cylindre. 4% d'inclinaison pour un plus de confort.







Joanne

Electric bed · Camilla eléctrica · Fauteuil électrique

ENG_ Lay down and pamper yourself.
It's time to live unique experiences.

ES_ Tumbarse y cuidarse. Es tiempo
para sentir experiencias únicas.

FR_ S'allonger et se faire soigner. Il
est temps de sentir des expériences
uniques.



Optional foot control
Control de pie opcional
Pédales de commande en option

Thought for you



Folding and extractable armrests
Reposabrazos abatibles y extraíbles
Accoudoirs rabattables et extractibles

High quality PU skin touch
upholstery
**Tapizado en PU Skin touch sin
costuras y fácil de limpiar**
Tapisé en PU Skin Touch sans
coutures et facile à nettoyer

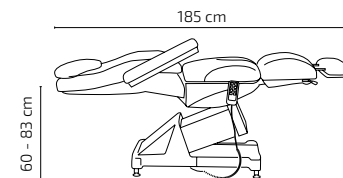
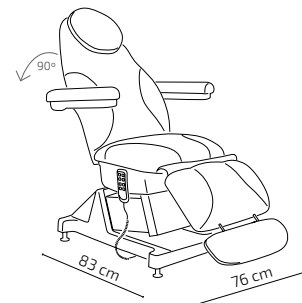



Wired control included
Mando de control incluido
Commande filaire incluse



Eva

Podiatry armchair · Sillón de podología · Fauteuil de podologie

ENG_ The pleasure of delicate, subtle and relaxing care.

ES_ El placer de un cuidado delicado, sutil y relajante.

FR_ Le plaisir d'un soin délicat, subtil et relaxant.

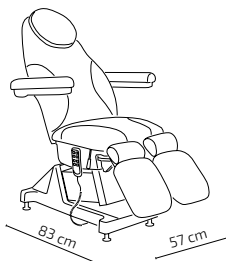
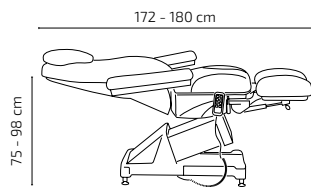

Sliding and independent footrest
Reposapiés independientes y desplazamiento lateralmente
Repose-pieds independant et déplaçable latéralement



Optional foot control
Control de pie opcional
Pédales de commande en option



Wired control included
Mando alámbrico incluido
Commande filaire incluse





Maya

Electric bed · Camilla eléctrica · Fauteuil électrique

ENG_ Designed in every detail for a fine, precise and perfectionist treatment.

ES_ Diseñada hasta el último detalle para un tratamiento fino, preciso y perfeccionista.

FR_ Conçue jusqu'au dernier détail pour un traitement délicat, précis et perfectionniste.

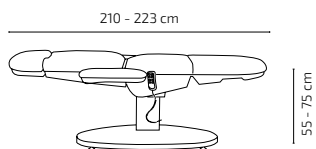
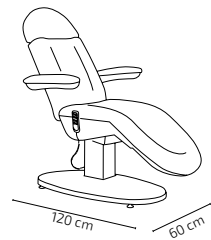

Adjustable footrest by gas piston
Reposapiés regulable mediante pistón de gas
Repose-pieds réglable en hauteur à l'aide d'un vérin à gaz



Optional foot control
Control de pie opcional
Pédales de commande en option





Folding and extractable armrests
Reposabrazos abatibles y extraíbles
Accoudoirs rabattables et extractibles

High quality PU skin touch upholstery
Tapizado Skin touch sin costuras y fácil de limpiar
Rembourré en PU Skin touch et facile à nettoyer



Wired control included
Mando alámbrico incluido
Commande filaire incluse



Cecil

Electric bed · Camilla eléctrica · Table électrique

ENG_ Optimal for an unforgettable treatment.

ES_ Óptima para un tratamiento inolvidable.

FR_ Parfaite pour un traitement inoubliable.

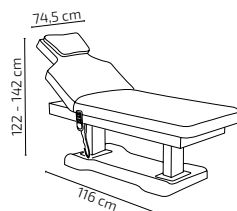
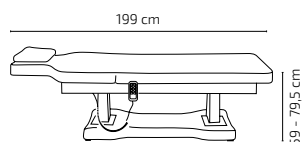

4 electric motors
4 motores eléctricos
4 moteurs électriques

Optional foot control
Control de pie opcional
Pédales de commande en option





Wired control included
Mando incluido
Commande filaire incluse

Mary

Electric bed · Camilla eléctrica · Table électrique

ENG_ Inspires satisfaction and pleasure. To get carried away and free from stress.

ES_ Inspira satisfacción y placer. Para dejarse llevar y liberarse del estrés.

FR_ Inspire satisfaction et plaisir. Pour se laisser aller et libérer le stress.



1 electric motors
1 motor eléctrico
1 moteur électrique

Wired control included
Mando alámbrico incluido
Commande filaire incluse



Optional foot control
Control de pie opcional
Pédales de commande en option

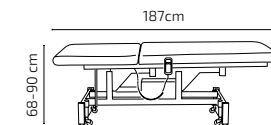
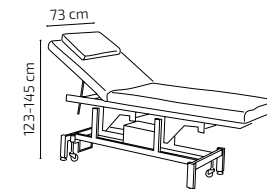

Get rid of stress



Yvette

Fixed facial bed · Camilla facial fija · Lit facial fixe



ENG_ Reinforced facial bed. The satisfaction of relaxing with total comfort. Made to last.

ES_ Camilla facial reforzada. La satisfacción de relajarse con un confort total fabricada para durar.

FR_ Fauteuil facial renforcé. La satisfaction de se détendre dans un confort total. Fabriqué pour durer.



5 years guaranteed structure
Estructura garantizada 5 años
Cadre garanti 5 ans

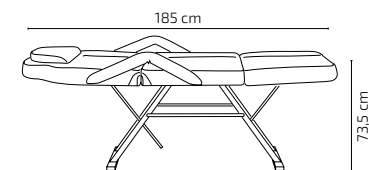

Made to last!

Upholstery PVC fire retardant
Tapizado de PVC de limpieza fácil
Revêtement en PVC retardant au feu et
facilement nettoyable



Adjustable backrest and footrest
Respaldo y reposapiés ajustables
Dossier et repose-pieds réglables

Facial hole and removable headrest
**Agujero facial y cojín reposacabezas
extraíble**
Trou facial et coussin repose-tête
amovible



Detachable armrests
Reposabrazos extraíbles
Accoudoirs extractibles

Liv

Hydraulic bed · Camilla hidráulica · Lit hydraulique

ENG_ The elegance that rises to the level of treatments. It offers work ergonomics, adaptability and comfort.

ES_ La elegancia que se eleva al nivel de los tratamientos. Ofrece ergonomía de trabajo, adaptabilidad y confort.

FR_ L'élégance qui s'élève au niveau des traitements. Offre ergonomie de travail, adaptabilité et confort.



5 years guaranteed structure
Estructura garantizada 5 años
Cadre garanti 5 ans

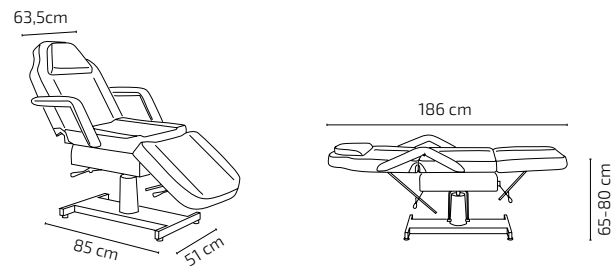

Side padding
Lateral acolchado
Rembourrage latéraux



Detachable armrests
Reposabrazos extraíbles
Accoudoirs extractibles

Adjustable backrest and footrest
Respaldo y reposapiés ajustables
Dossier et repose-pieds réglables





Miriam

Adjustable height bed · Camilla altura regulable · Lit à hauteur réglable

ENG_ Wooden massage bed;
an inspiration for a first-class
massage.

ES_ Camilla de madera; toda
una inspiración para un
masaje de primera.

FR_ Table en bois; toute une
inspiration pour un massage
de qualité.

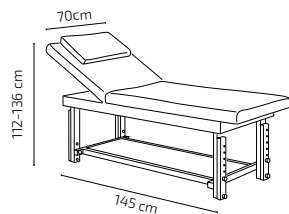
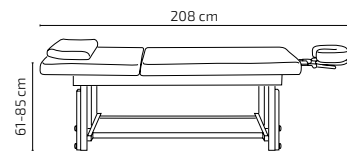

The most powerful sensitivity



Height-adjustable legs
Pies regulables en altura
Pieds réglables en hauteur



High quality PU skin touch upholstery
Tapizado de PU skin touch sin costuras y fácil de limpiar
Revetement en PU skin touch de haute qualité



Ergonomic silicone facial cushion
Cojín facial ergonómico de silicona
Oreiller facial ergonomique de silicone



Olga

Fixed bed · Camilla fija · Lit fixe

ENG_ Pamper, care... The nature of a good massage on a natural wooden bed.

ES_ Mimar, cuidar... La naturaleza de un buen masaje en una camilla de madera natural.

FR_ Choyer, prendre soin... La naturalité d'un bon massage sur une table en bois naturel.

Removable articulated head
Cabezal articulado extraíble
Tête articulée amovible

Solid oak structure
Estructura de madera de roble macizo
Structure en bois de chêne massif

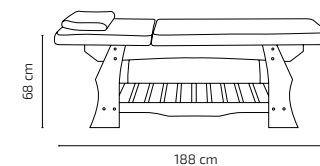
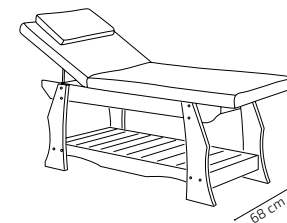

Pillie

Matt · Alfombra · Tapis

ENG_ Anti fatigue oval gel mat. Prevents pain and encourages good posture.

ES_ Alfombra antifatiga de forma rectangular. Previene el dolor y promueve una buena postura.

FR_ Tapis anti-fatigue de forme carrée. Préviens les douleurs et favorise une bonne posture.



Non-slip base
Base antideslizante
Base antidérapante



Nilsa

Fixed bed · Camilla fija · Lit fixe

ENG_ Robust and sturdy for demanding massages. Relax and enjoy in equal proportion.

ES_ Robusta y resistente para masajes exigentes. Relajarse y disfrutar a partes iguales.

FR_ Robuste et résistante pour massages exigeants. Se détendre et jouir à parts égales.

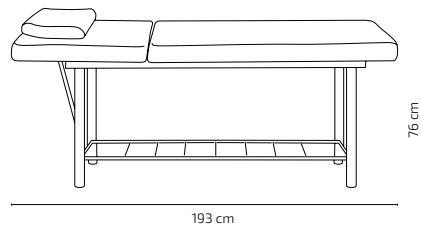
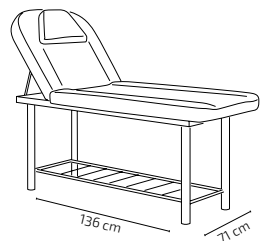

Facial hole and removable headrest
Agujero facial y cojín reposacabezas extraíble
Trou facial et coussin repose-tête extractible

Solid metal structure
Estructura metálica de gran resistencia
Structure métallique de grande résistance



It all starts here



Sansa

Fixed bed · Camilla fija · Lit fixe

ENG_ Folding massage bed with the perfect balance between stability and movement.

ES_ El compañero de aventuras. Camilla plegable con el equilibrio perfecto entre estabilidad y movimiento.

FR_ Le compagnon d'aventures. Table pliante avec l'équilibre parfait entre stabilité et mouvement.

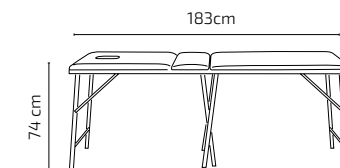
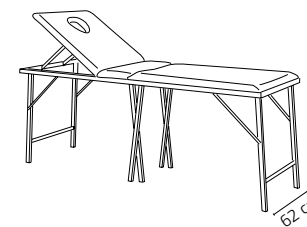

*Follows you
everywhere*



Transport bag · Bolsa de transporte · Sacoche de transport:
108x80cm





Remi

Make up mirror · Espejo de maquillaje · Fauteuil de maquillage

ENG_ An elegant and simple mirror.
Perfectly glammourous.

ES_ Espejo elegante y sobrio. El aliado perfecto del glamour.

FR_ Miroir élégant et sobre. L'alié parfait du glamour.

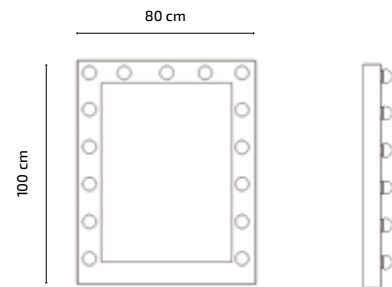

Double USB side port
Doble puerto USB
Double USB latéral



Adjustable LED light
Luz LED regulable
Éclairage LED réglable

Emily

Make up table · Mesa de maquillaje · Table de maquillage

ENG_ Minimalist style. The pleasure of having your make up to hand.

ES_ Estilo minimalista. El placer de tener el maquillaje siempre a mano.

FR_ Style minimaliste. Le plaisir de toujours avoir le maquillage a portée de main.

White lacquered MDF tabletop
Estante de MDF lacado blanco
Étagères en MDF laqué blanc

Tapered metallic legs
Pies cónicos metálicos
Pieds coniques métalliques

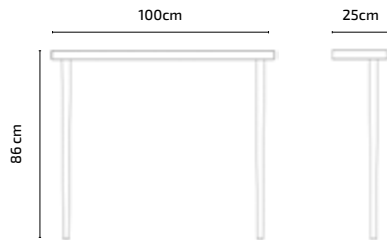

Magic mirror on the wall, who is the prettiest of the world?



Silvia W

Make up armchair · Sillón de maquillaje · Fauteuil de maquillage

ENG_ Ergonomic and user-friendly makeup chair. An experience that makes a difference.

ES_ Sillón de maquillaje ergonómico y manejable. Una experiencia que no deja indiferente.

FR_ Fauteuil de maquillage ergonomique et maniable. Une expérience qui ne laisse pas indifférent.

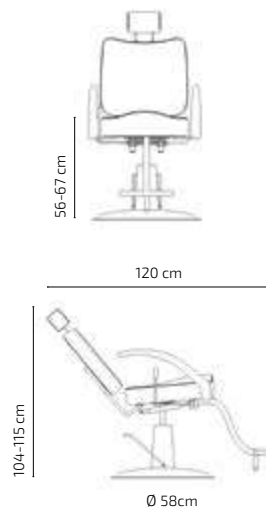

Removable head-rest
Reposacabezas extraíble
Repose-tête extractible

Footrest with stabilizing foot
Reposapiés con soporte anti-vuelco
Repose-pieds avec pied stabilisateur



Reinforced structure
Estructura reforzada
Structure renforcée



300 N double gas spring
Doble pistón de gas de 300N
cada uno
Double vérin à gaz de 300N
chacun







Lucía

Manicure table · Mesa de manicura · Table de manucure

ENG_ Designed to encourage comfort and boost creativity.

ES_ Diseñada para potenciar la creatividad, ofreciendo la máxima comodidad.

FR_ Conçue pour stimuler la créativité en offrant un maximum de confort.



Metal feet with levelers
Pies metálicos con niveladores
Pieds métalliques avec niveleurs

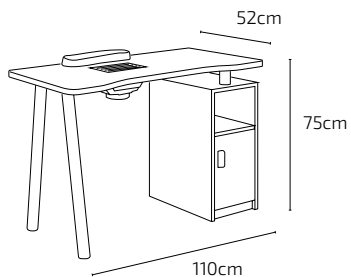

Nail vacuum cleaner with dust collector
Aspirador con colector de polvo
Aspirateur avec capteur de poussière



Hand cushion included
Cojín reposamanos incluido
Coussin repose-mains inclu





Marion

Manicure table · Mesa de manicura · Table de manucure

ENG_ Well-being over everything. The practical and most desirable manicure table. Everything at your fingertips.

ES_ Bienestar por encima de todo. La mesa de manicura más deseada y práctica, todo al alcance de la mano.

FR_ Bien-être par-dessus tout. La table de manucure la plus souhaité et pratique. Tout à portée de main.



Storage column with 2 large drawers and storage open-space.

Columna con 2 cajones y espacio de almacenaje

Colonne avec 2 tiroirs et espace de rangement

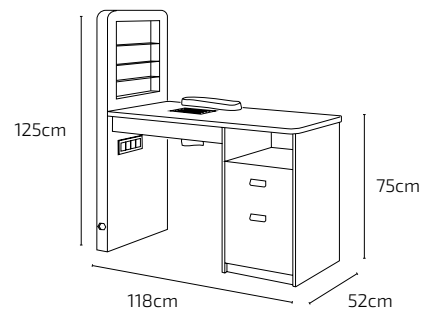

The perfect partner



Nail vacuum cleaner with dust collector
Aspirador con colector de polvo
Aspirateur de table avec sac

Hand cushion included
Cojín reposamanos incluido
Coussin repose-mains inclu

White lacquered panel with LED display
Panel lacado blanco y expositor LED
Panneau laqué blanc avec présentoir LED



4-pin power socket included (max 2.000W)
Interruptor de luz con toma de corriente de 4 clavijas (max 2.000W)
Bloc de 4 prises de courant (max 2.000W)

Olson

Manicure stool · Taburete de manicura · Tabouret de manucure

ENG_ The perfect assistant to enjoy beauty anywhere.

ES_ El asistente perfecto. Para disfrutar de la belleza en todas partes.

FR_ L'assistant parfait. Pour jouir de la beauté partout.

White lacquer tray
Bandeja lacada blanca
Plateau laqué blanc

Soft PVC upholstered seat cushion
Asiento acolchado y tapizado de PVC retardante al fuego
Assise rembourrée et revêtement en PVC retardant au feu

Height-adjustable and swivel structure
Estructura giratoria ajustable en altura
Structure pivotante et réglable en hauteur

3 removable storage trays
3 bandejas de almacenamiento extraíbles
3 bacs de rangement amovibles

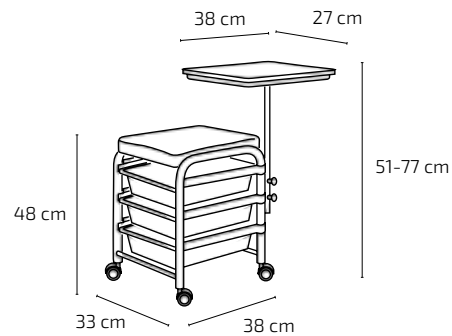

Mat

Pedicure foot-rest · Reposapiés para pedicura · Repose-pied pour pédicure

ENG_ Ergonomic footrest, simple and practical. For a perfect relaxation.

ES_ Reposapiés ergonómico, sencillo y práctico. Para un relax perfecto.

FR_ Repose-pieds ergonomique, simple et pratique. Pour un relax parfait.

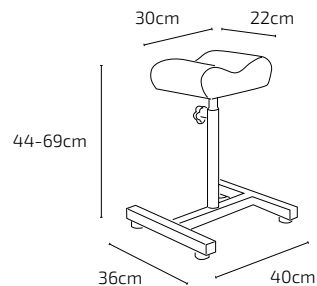

Easily removable
Fácilmente desmontable
Facilement démontable

Adjustable wheel
Altura ajustable
Molette de réglage

H form metallic base to assure a perfect balance

Estabilidad perfecta gracias a la base metálica en forma de H

Base métallique en forme de H pour un équilibre parfait



Vicky

Pedicure armchair · Sillón de pedicura · Fauteuil de pédicure

ENG_ Enjoying such a refreshing experience has never been easier. Comfort, innovation and elegance in a pedicure chair.

ES_ Disfrutar de una experiencia tan refrescante, nunca había sido tan fácil. Comodidad, innovación y elegancia en un sillón de pedicura.

FR_ Jouir d'une expérience si rafraîchissante n'a jamais été aussi simple. Confort, innovation et élégance sur un fauteuil de pédicure.

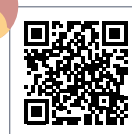
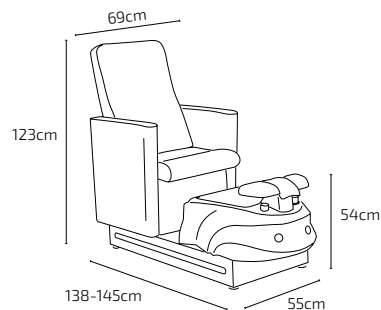



Footbath with hydromassage with jet function and chromotherapy.

Bañera para pies con hidromasaje, función jet y cromoterapia.

Bain de pieds avec hydromassage par jet d'eau et chromothérapie.



Extendable hose and mixer taps included.

Manguera extensible y grifería monomando incluidos.

Douchette et robinetterie incluses.



Water pump for a quick evacuation.

Bomba de agua para un desagüe rápido.

Pompe à eau pour une évacuation rapide.



The seats slides to adjust the position and facilitate access.

Asiento deslizable para ajustar la posición y facilitar el acceso.

L'assise glisse pour régler la position et faciliter l'accès.



Anita

Pedicure armchair · Sillón de pedicura · Fauteuil de pédicure

ENG_ Offers a unique experience in any corner. Created to make use of the space.

ES_ Ofrece una experiencia única en cualquier rincón. Creado para aprovechar el espacio.

FR_ Offre une expérience unique n'importe où. Créé pour profiter de l'espace.



Injected PU armrests
Brazos de PU inyectado
Accoudoir en PU injecté

Height adjustable and swivel seat by hydraulic pump
Asiento regulable en altura y giratorio mediante bomba hidráulica
Assise réglable en hauteur et pivotante par pompe hydraulique

Height adjustable manually rotating footrest
Reposapiés ajustable en altura y giratorio manualmente
Repose-pieds réglable en hauteur et pivotant manuellement

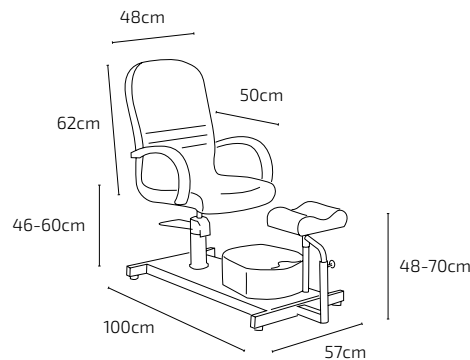

Foot bath with non-slip mat
Bañera para pies con alfombra anti-deslizante
Vasque pour pieds avec tapis anti-dérapant



Feeling good



Akland collection



Edd



Gala

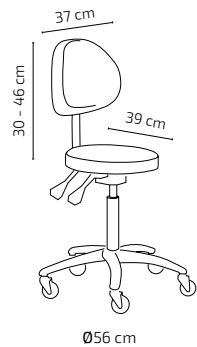

53-73 cm
38-45 cm (XS)



Rita



Eli

ENG_ Aesthetic stools created to enjoy their ergonomics optimally.

ES_ Taburetes de estética creados para disfrutar de su ergonomía de manera óptima.

FR_ Tabourets d'esthétique créés pour jouir de son ergonomie de manière optimale.

Available with smaller gas lift stem (XS)

Disponibles con pistón de gas más pequeño (XS)

Disponibles avec vérin à gaz plus petit. (XS)

Get your team ready!



It is possible to adjust the height and the inclination of the seat and backrest

Regulable en altura, inclinación del asiento y de respaldo ergonómico

Possibilité de régler la hauteur et l'inclinaison de l'assise et le dossier ergonomique



5 star aluminium base
Base estrella 5 radios aluminio
Base étoile 5 branches en aluminium



Silent and soft polyurethane wheels with anti-hair system

Ruedas de poliuretano ligeras y silenciosas con sistema antipelo

Roulettes en polyuréthane, douces et silencieuses avec système anti-cheveux



Gordon W

Stool · Taburete · Tabouret

ENG_ The perfect combination between movement and comfort.

ES_ La magnífica combinación entre el movimiento y la comodidad.

FR_ La parfaite combinaison entre mouvements et bien-être.

Gas spring height adjustable seat
Asiento con respaldo, ajustable en altura mediante pistón de gas
Assise avec dossier réglable en hauteur par vérin à gaz



Silent and soft polyurethane wheels with anti-hair system

Ruedas de poliuretano ligeras y silenciosas con sistema antipelo

Roulettes en polyuréthane, douces et silencieuses avec système anti-cheveux

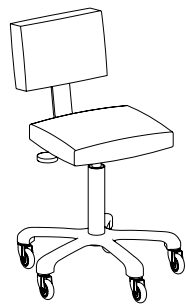

Ø66cm

49-69cm (GORDON W)

34-41cm (GORDON WXS)



Gordon WXS



Quin

Trolley · Carro · Chariot

ENG_ The best ally for the job.
Perfect dimensions.

ES_ El mejor aliado para el trabajo.
Medidas perfectas.

FR_ Le meilleur allié. Conçu pour
offrir un confort maximum.
Fabriqué pour perdurer dans le
temps.

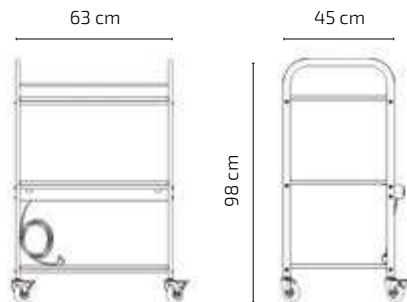

Polyurethane castors with anti hair protection. Two castors with brake

Ruedas de poliuretano antipelos, 2 de ellas con freno

Roulettes en polyuréthane anti-cheveux, 2 d'entre elles avec freins



Base with 4 plugs and a 1,80m cord
Base con 4 enchufes y un alargador de 1,80m

Base avec 4 prises et rallonge de 1,80 m



Reception & waiting area

Recepciones y esperas

Réceptions et salles d'attente

Floyd W

Reception · Recepción · Réception

ENG_ Versatile and elegant reception desk for displaying products in style.

ES_ Recepción versátil y elegante para exhibir productos con clase.

FR_ Réception polyvalente et élégante pour présenter des produits avec du style.



2 USB ports, EU and UK plug supported
2 puertos USB y enchufe EU/UK
2 ports USB et prises EU/UK

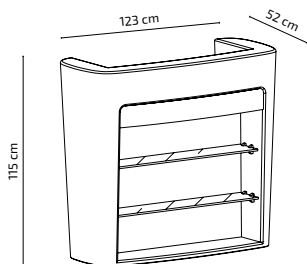

Fibber glass reception
Recepción de fibra de vidrio
Reception en fibre de verre

Sliding cristal doors product storage and LED lighting display

Expositor con LED y espacio para almacenar, separado con puertas correderas de cristal

Présentoir avec éclairage LED et espace de rangement avec portes coulissantes en verre

Doors and drawers with lock
Puertas y cajones con llave
Portes et tiroirs avec clé



Acrylic front panel
Panel frontal acrílico
Panneau avant acrylique



Louise

Waiting table · Mesa de espera · Table d'attente

ENG_ Adaptable to all kinds of receptions.
Combines to perfection with chairs and sofas to create custom environments.

ES_ Adaptable a todo tipo de recepciones.
Combina a la perfección con sillas y sofás para crear ambientes personalizados.

FR_ Adaptable à tous types de réceptions.
Combine a la perfection avec chaises et canapés pour créer des ambiances personnalisées.

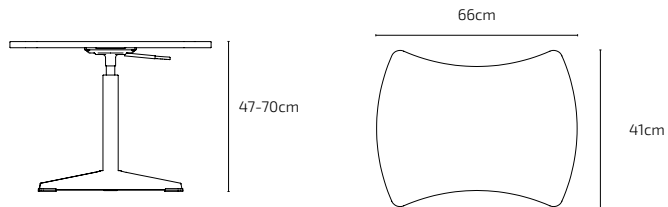

Gas spring height adjustable table
Mesa ajustable mediante pistón de gas
Table réglable par vérin à gaz



Mia basic

Waiting chair · Silla de espera · Chaise d'attente

ENG_ Ergonomic chair for total comfort. Offers style and design.

ES_ Silla ergonómica para disfrutar de un confort total. Ofrece estilo y diseño.

FR_ Chaise ergonomique pour jouir d'un confort total. Offre style et design.

Ergonomic chair, with metallic structure
Silla ergonómica, con estructura metálica
Chaise ergonomique avec structure métallique



- Ref. 1028-6/96/07
- Ref. 1028-6/96/11
- Ref. 1028-6/96/17
- Ref. 1028-6/96/98
- Ref. 1028-6/96/08

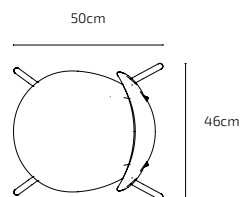
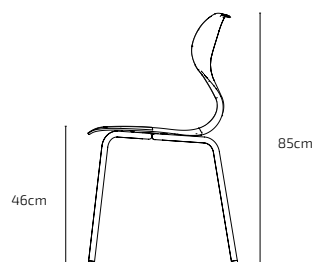

Chloe WX

Waiting chair · Silla de espera · Chaise d'attente

ENG_ Inevitable attraction, avant-garde style with an elegant and persistent design.

ES_ Atracción inevitable, de estilo vanguardista con un diseño elegante y persistente.

FR_ Son design contemporain offre un confort total et agréable, alliant la synergie entre fauteuil et être.

Metallic inner structure
Estructura interior metálica
Structure intérieure métallique

Injected PU foam
Espuma de PU inyectada
Mousse de PU injecté





Beauty Center





Tables and storage

Mesas y almacenaje

Tables et stockage

Square

Table · Mesa · Table

ENG_ Para espacios reducidos, mesas reducidas.

ES_ Para espacios reducidos, mesas reducidas.

FR_ Para espacios reducidos, mesas reducidas.



Adjustable legs
Pies ajustables en altura
Pieds réglable en hauteur

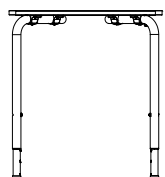

65 - 76 cm

50 cm

68 cm



Space

Table · Mesa · Table

ENG_ Provides a light and stylized vision while ensuring long durability.

ES_ Aporta una visión ligera y estilizada a la vez que asegura una larga durabilidad.

FR_ Légère et stylisée à la fois que robuste qui assure une longue durée de vie.

Perfect table for offices and meetings
Mesa ideal para reuniones o despachos
Table idéale pour réunions ou bureaux



TAMAÑOS · SIZES · TAILLES

120X65 cm	Ref. 260R-6-07/22
180X65 cm	Ref. 260R-6-08/22
120X80 cm	Ref. 260R-6-05/22
140X80 cm	Ref. 260R-6-04/22
160X80 cm	Ref. 260R-6-01/22
180X80 cm	Ref. 260R-6-02/22



69 cm

76 cm

Alufloop

Folding table · Mesa abatible · Table rabattable

ENG_ Dynamics table that brings versatility to a workspace. Fold down, move and store.

ES_ Mesa dinámica que aporta versatilidad a un espacio de trabajo. Abatir, desplazar y guardar.

FR_ Créé pour apporter polyvalence à un espace de travail lorsqu'il est nécessaire. Rabattre, déplacer et ranger.



TAMAÑOS · SIZES · TAILLES

139x70 cm

Ref. 2048DNR-01/22

160x80 cm

Ref. 2048DNR-02/22

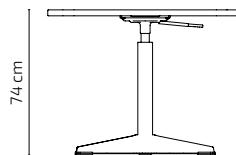

Folding table, perfect for using in different spaces

Mesa plegable, ideal para usar en diferentes espacios

Table pliante, idéale pour utiliser dans différents espaces



Victory collection

ENG_ Created to succeed. Perfect for product display and storage. It offers design, sturdiness and stability.

ES_ Creadas para triunfar. Perfectas para la exposición y almacenaje de productos. Ofrece diseño, robustez y estabilidad.

FR_ Créé pour triompher. Parfaite pour présenter et stocker des produits. Offre design, robustesse et stabilité.



80cm

VICTORY 532-502



80cm

VICTORY 532-501



80cm

VICTORY 632-504



160cm

VICTORY 534-501



160cm

VICTORY 534-509



160cm

VICTORY 534-508



160cm

VICTORY 634-508

Optional · Opcional · Optionnel



CERRADURA · LOCK · SERRURE
Ref. 521



PACK 4
RUEDAS · CASTORS · ROULETTES
Ref. 5240





Upholstery

Tapizados

Capitonnage



ITEMS AVAILABLE TO UPHOLSTER
ARTICULOS DISPONIBLES PARA TAPIZAR
ARTICLES DISPONIBLES POUR TAPISSER

STYLING CHAIRS · SILLONES DE CORTE
FAUTEUILS DE COUPE

OCEAN

DORA

FREYA

MOLLY

LORIS

FANDY

BARBER CHAIRS · SILLONES DE BARBERO
FAUTEUILS BARBIER

HUGO

HUGO B

JONES

CLINT

KIRK

JOEY

KARL

PRINCE

SILVIA B

SHAMPOO UNITS · LAVACABEZAS
BACS À SHAMPOING

CHARLY

BASIL

THOMAS

RALPH

JACOB

OLIVER

PETER

STOOLS · TABURETES · TABOURETS

GORDON

IAN

LEO

NIL

RECEPTIONS · RECEPCIONES · RÉCEPTIONS

BOB

SAM

JAY



**Customize your Mirplay
products**

**Personaliza tus productos
Mirplay**

**Personnalisez vos produits
Mirplay**

ENG_ If you wish to add a more personal touch to our products, take advantage of the good conditions we offer for re-upholstery.

ES_ Si necesitas darle un toque más personal a nuestros productos, aprovecha las buenas condiciones que ofrecemos de retapizado.

FR_ Si vous avez besoin de donner une touche plus personnelle à nos produits, profitez des bonnes conditions que nous offrons de re-tapissage.



Overview · Resumen · Resumé



p.12 Hugo



p.12 Hugo B



p.16 Clint B



p.16 Clint Br



p.20 Kirk



p.22 Jones



p.24 Joey



p.25 Pol



p.26 Karl



p.28 Prince



p.30 Silvia B



p.31 Catty



p.32 Millie



p.33 Layla



p.38 Ocean BF



p.38 Ocean F



p.38 Ocean S



p.38 Ocean R



p.40 Dora F



p.40 Dora BF



p.40 Dora S



p.40 Dora R



p.42 Chloe F



p.42 Chloe BF



p.42 Chloe S



p.42 Chloe R



p.42 Chloe WF



p.42 Chloe WBF



p.42 Chloe WS



p.42 Chloe WR



p.42 Chloe GF



p.42 Chloe GS

Overview · Resumen · Resumé



p.42 Chloe GR



p.42 Chloe RF



p.42 Chloe RS



p.42 Chloe RR



p.42 Chloe BLF



p.42 Chloe BLS



p.42 Chloe BLR



p.44 Freya



p.45 Molly



p.46 Loris F



p.46 Loris BF



p.46 Loris R



p.46 Loris S



p.48 Bertie



p.49 Fandy F



p.49 Fandy BF



p.49 Fandy R



p.49 Fandy S



p.50 Horace



p.52 Petra F



p.52 Petra BF



p.52 Petra S



p.52 Petra R



p.54 Gat



p.54 Brenda



p.55 Jilly



p.60 Charly



p.64 Basil



p.66 Thomas



p.68 Marvin



p.70 Ralph



p.72 Peter

Overview · Resumen · Resumé



p.73 Lee



p.73 Cole



p.74 Jacob



p.78 Oliver



p.80 Bonnie



p.80 Buddy



p.80 Rex



p.80 Den



p.81 Joker



p.84 Jules



p.86 Bobbie W



p.86 Bobbie B



p.87 Richard



p.88 Patrick W



p.88 Patrick B



p.89 Robin



p.90 Zoel W



p.90 Zoel B



p.91 Roger B



p.92 Poppy P



p.94 Chris



p.94 Jan



p.95 Troy



p.95 Dan



p.95 Todd



p.95 Mack



p.98 Twins



p.100 Gordon B



p.102 Ian



p.103 Leo



p.103 Nil



p.106 Wally

Overview · Resumen · Resumé



p.107 Noah



p.108 Alan



p.109 Holly



p.110 Skye



p.111 Iris



p.112 Vitus



p.113 Lenny



p.114 Adam



p.115 Jeff



p.115 Moe



p.118 Floyd B



p.120 Finch



p.122 Adrian



p.124 Dylan



p.125 Thierry



p.126 Dock



p.128 Bob



p.128 Sam



p.128 Jay



p.130 Charlotte BL



p.130 Charlotte G



p.130 Charlotte R



p.132 Dora X



p.132 Petra X



p.132 Fandy X



p.132 Loris X



p.132 Ocean X



p.132 Chloe X



p.132 Chloe BLX



p.132 Chloe GX



p.132 Chloe RX

Overview · Resumen · Resumé



p.136 Joanne



p.138 Eva



p.140 Maya



p.142 Cecil



p.144 Mary



p.146 Yvette



p.148 Liv



p.150 Miriam



p.152 Olga



p.157 Pillie



p.154 Nilsa



p.156 Sansa



p.160 Remi



p.161 Emily



p.162 Silvia W



p.166 Lucía



p.168 Marion



p.170 Olson



p.171 Mat



p.172 Vicky



p.174 Anita



p.178 Edd



p.178 Gala



p.178 Rita



p.178 Eli



p.178 Edd XS



p.178 Gala XS



p.178 Rita XS



p.178 Eli XS



p.180 Gordon W



p.180 Gordon WXS



p.180 Gordon XS

Overview · Resumen · Resumé



p.180 Ian XS



p.180 Leo XS



p.180 Nil XS



p.181 Quin



p.184 Floyd W



p.186 Louise



p.187 Mia basic



p.188 Chloe WX



p.192 Square



p.192 Space



p.193 Alufloop



p.194 Victory 632-504



p.194 Victory 634-508



p.194 Victory 532-502



p.194 Victory 532-501



p.194 Victory 534-501



p.194 Victory 534-509



p.194 Victory 534-508





Follow us!



www.kappersleverancier.nl

