

MIHOGO

MIHOGO RX4.0

Electric Bike Operating Instructions V1.0

ADD: 445 LUCAS AVE LOS ANGELES, California, 90017 USA

E-mail: Support@mihogo.com

Website: <http://mihogo.com>



Please read this manual carefully and do not use the vehicle until you fully understand the performance of the vehicle. Please keep the instruction manual properly.

CONTENTS

1.Product Overview	01
2.Electric bicycle introduction	03
3.Assembly Instructions	04
4.Function introduction	10
5.Electric bicycle parameters	18
6.Safe use instructions	19
7.Recommends	21

1 Product Overview

The electric bicycle



Accessories

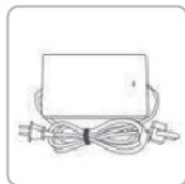

Accessories x1



Instruction x1



Toolkit x1

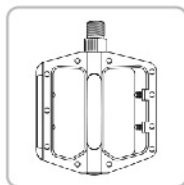

Pedal x2

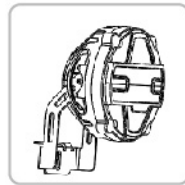

Front light x1

 Please carefully check whether the items in the packaging box are complete. If there is any lack or damage, please contact our customer service.

2 Electric bicycle introduction



3 Assembly Instructions

1. Install the front wheel onto the front fork as explained below

⚠ WARNING

Do not touch the brake rotor, which has sharp edges and can cause serious injury. Touching the brake rotor or brake pads with bare skin can also transfer natural oils to either component, which can decrease braking performance. When installing the front wheel, ensure that you don't touch the brake rotor or pads with bare hands. Wear clean gloves if needed.

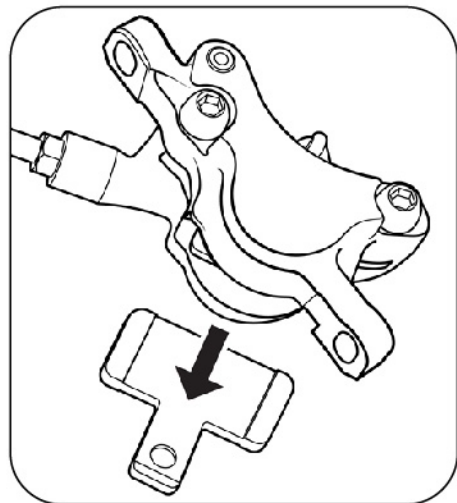

Install the skewer through the front wheel hub, starting from the brake-rotor side. Make sure not to touch the brake rotor. Reinstall the cone spring on the skewer. Ensure both cone springs point inward. Keep the lever open and thread on the thumbnut a couple of turns, leaving enough room for the fork dropouts.

- a Remove the hydraulic brake pad spacer from the brake caliper on the front wheel.

⚠ NOTICE

If the front wheel is not installed or if the hydraulic brake pad spacer is missing, do NOT squeeze the brake levers. Doing so can cause the brake pads to clamp together too much and prevent the brake rotor from fitting between the pads. If this happens to you, install the brake pad spacer back between the pads to create more space between the brake pads for the brake rotor.

- b Pay attention to the wheel axle installation in the order shown in the figure; Carefully lift the front of the bike and lower the fork onto the wheel so that the brake rotor enters the caliper, between the brake pads, and the axle enters the fork dropouts fully. If installing the front wheel is difficult, reinsert the pad spacer to create more space between the brake pads for the brake rotor. Then remove the spacer and install the wheel. If installing the front wheel is difficult, use a 5 mm Allen wrench to turn the inner pad adjustment dial counterclockwise one or two clicks to increase the space between the brake pads. Try to install the wheel again.

- c Check that the wheel is fully seated in the dropouts, that the wheel axle is level and parallel to the ground, and that the wheel is centered.

- d Use a 14mm open wrench to tight the wheel axle bolt to recommended torque value at 25-33Nm.

⚠ WARNING

An improperly secured front or rear wheel can cause loss of control, accidents, serious injury, or death. Check that both wheels are properly secured during assembly and before each ride.

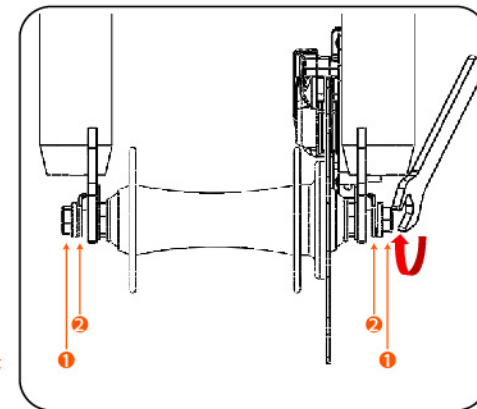

- * ① M10 flange nut
② Safety hook

2. Install the front fender and headlight.

- Assembly Fender support rod on the front fender.
- Locate the fender and headlight mounting hardware in the front fork arch.
- Pass the fender from the back of the front wheel, under the fork arch.
- Install the fender/headlight mounting hardware through the headlight bracket, fender, and fork .
- Plug in the headlight connector. Line up the internal notch and pins and external arrows, and press directly together without twisting.
- Check that the fender and headlight are centered.
- Adjust the headlight angle slightly downward so it will not blind oncoming traffic.

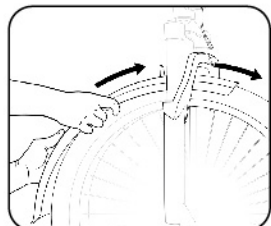
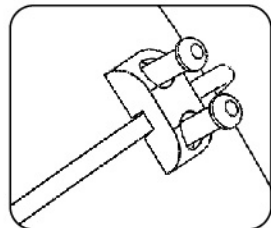

Pass the fender from the back of the front wheel.

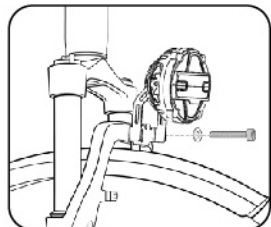

Headlight mounting hardware.

3. Install the pedals

- Locate the right-side pedal, which is marked "R," should have an "R" sticker attached, and has a smooth pedal axle. The right pedal goes on the crank on the drivetrain side of the bike, which has the chain and is the same as a rider's right side when seated on the bike.
- Place a pea-size or slightly smaller amount of bicycle grease onto the threads of the right pedal.
- Carefully thread the right pedal onto the right crank by turning clockwise (toward the front of the bike). Do so slowly and gently by hand. Do not cross thread or damage the threads.
- Place a pea-size or slightly smaller amount of bicycle grease onto the threads of the left pedal.
- Carefully thread the left pedal onto the left crank by turning counterclockwise (toward the front of the bike). The reverse threaded left pedal is marked with an "L," should have an "L" sticker attached, and has notches on the pedal axle. Thread slowly and gently by hand without cross-threading or damaging the threads.
- Tighten each pedal using a pedal wrench to avoid damage caused by wider wrenches.
- Torque each pedal to 35 Nm.
- Wipe off any excess bicycle grease.

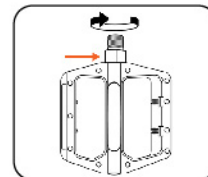

Right pedal with smooth pedal axle.

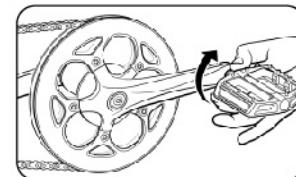

Thread the right pedal onto the right crank gently by hand, turning clockwise.

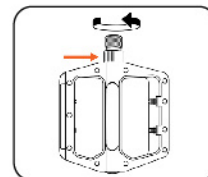

Left pedal with notches on the pedal axle.

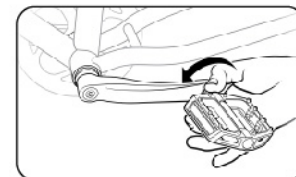

Thread the left pedal onto the left crank gently by hand, turning counterclockwise.

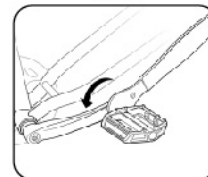

Pedal wrench on left pedal.

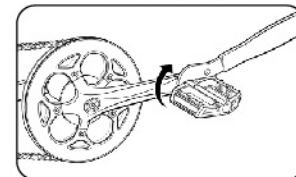

Pedal wrench on right pedal.

4. Prepare your ebike's power system for use, assembly the front battery

- a** we need to fold the frame to assemble the battery.
- b** There is a safety lock on the buckle; first press the button down on the folding buckle, if you find it very difficult to press down the button you can press the buckle to the frame first.
- c** Use two fingers to pull the buckle out.
- d** Fold the frame until the included angle is about 120°.
- e** make sure that the battery locking pin is not out and then insert the battery.
- f** The battery must be locked after it is installed in place.
⚠ WARNING
No lock the battery will lead to the interface is inaccurate and easy to be damaged.
- g** Carefully unfold the frame, and let the discharge socket be identical with the battery port.
⚠ WARNING
Make sure that the discharge lines of the power supply have been connected before the connection.
- h** Closed the buckle, then make sure that the button is out.
⚠ WARNING
Make sure the safety lock is working, first make sure the button is out of the buckle, second the folding buckle can not be opened by pulling hard.

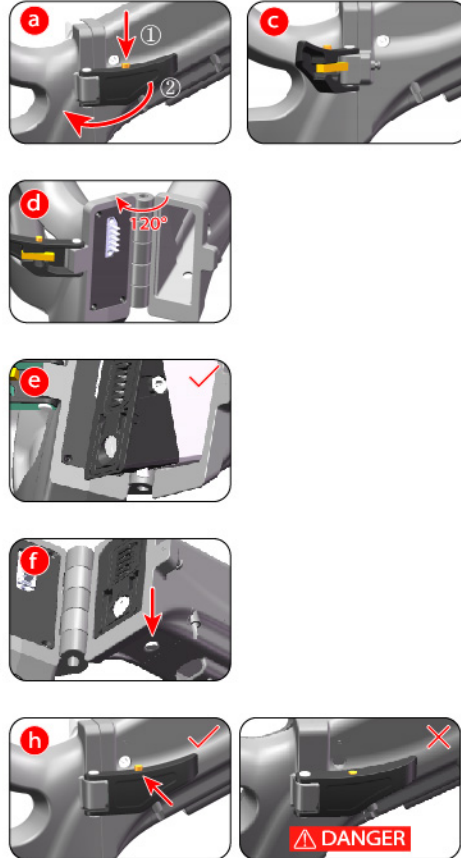

5. Adjusting the seat height

An ideal seat height for most riders allows them to be comfortable and get the best pedaling efficiency. When the rider is seated, they should be able to place the ball of their foot on the pedal at its lowest position while their leg is almost fully extended, with the knee slightly bent. The seat should never be so high that the rider must rock side to side or fully straighten their legs while pedaling. And the seat must never be pulled out so far that the minimum insertion point is above the seat tube (see illustration). Depending on a rider's preference, ability, and amount of experience with bike and ebike riding, lowering the seat so the rider can put one or both feet on the ground without dismounting from the seat may offer a safer and more comfortable experience while operating the bike;



Seatpost out TOO FAR The minimum insertion point on the seatpost must be inserted into the

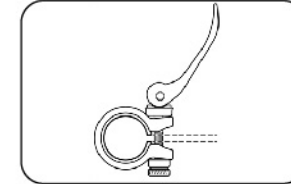

Open the quickrelease lever

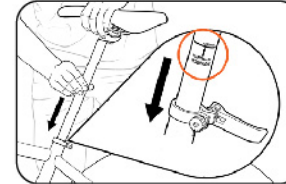

Insert the seatpost, ensuring the minimum insertion point (circled in orange) goes into the seat tube



Close the quick-release lever using your palm

1. Open the seatpost quick-release lever.
2. Slide the seatpost in or out of the seat tube to a height appropriate for your leg length and preference. Do not extend the seatpost beyond the minimum insertion marking etched onto the seatpost.
3. Align the quick release clamp opening with the notch in the seat tube, and close the quick-release lever fully. Closing the lever should require enough pressure that it leaves an imprint in your hand. When closed, the seat should not move up, down, left, or right. If needed, adjust the lever tension by turning the adjustment nut opposite the quick-release lever.
4. Try out your seat fit, and repeat steps 1-3 if the seat position needs a bit more adjusting.

⚠ DANGER

Overextending the seatpost can cause it to break or fall off your bike, which will put you at very high risk of serious injury or death. Avoid this danger by inserting your seatpost into the seat tube far enough that the minimum insertion point is no longer visible.

6. Adjusting for comfort and safety

The following steps are critical for your comfort and safety, and must be performed before your first bike ride. We recommend that you consult a bike fitting professional such as a certified, reputable bike mechanic who specializes in bike fit.

7. Adjusting the seat angle and horizontal position

Seat adjustment bolt with Allen wrench Many riders will prefer the seat to be roughly parallel to the ground, with its horizontal position in the middle of the range marked on the seat rails. To change the angle and horizontal position of the seat:

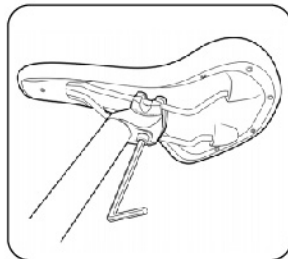

Seat adjustment bolt with Allen wrench

1. Use a 6 mm Allen wrench to loosen (but do not remove) the seat adjustment bolt on the clamp located underneath the seat.
2. Move the seat backward or forward and tilt to adjust the angle. Do not exceed the limit markings etched into one of the seat rails, which show how far you can safely move the seat forward and backward.
3. Ensure the top of the seat rail clamp is aligned directly over the bottom of the clamp so that the seat adjustment bolt will clamp the seat rails properly. Then, while holding the seat in the desired position, use a 6 mm Allen wrench to tighten the seat

⚠ WARNING

A loose seat clamp or seat adjustment bolt can cause loss of control, bike/property damage, serious injury, or death. Prior to first use, be sure to tighten the seat clamp via the seat adjustment bolt properly. Regularly check to make sure that the seat adjustment bolt is properly tightened and the clamp is secure on the seat rails.

8. Assembly the rear fender

1. Disassemble the screw on the Rear shelf;
2. Move the rear fender Connecting piece to the tube hole;
3. Fix with bolts and nuts; let the fender in the center of the wheel.

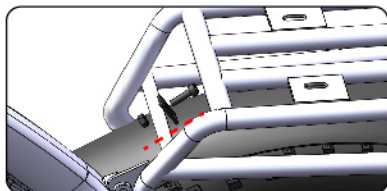

4 Function introduction

1. Definition of instrument display content



Basic parameters of display

dimension	length, width and height	89.3*60.8*80 (mm)
	screen size	3.5"
screen	pixel	320x480 PX
Core data	Working voltage	48V
	Working temperature	-20°, +50°
	Waterproof grade	IP67

2. Display key definition

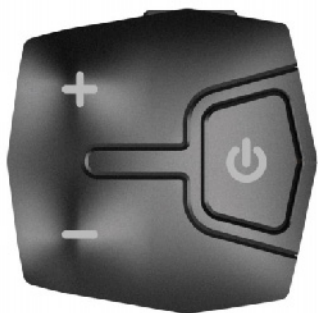

KEY	FUNCTION
" + " key	Short press to Gear upshift
	Long press to turn the headlight on/off
	Short press to choose list after enter the setting
" ⏻ " key	Long press to turn the Power on/off
	Short press to enter the instrument setting
" - " key	Short press to Gear downshift
	Short press to choose list after enter the setting

* Remarks: Long press more than 2.5 seconds
Short press less than 0.5 second

3. General operation

- 1 Long press ⏻ to turn the Power on; No password by default, if you want to set a password Please follow the setting instructions;
- 2 Default gear 0 for startup, press " + " to choose the assisted gear 1 to 5; the e-bike no working at zero gear, Power assisted gear is at 1-5 gear. The fastest speed is at 5 gear. The Half throttle can reach the fastest speed at any gear at 1-5 gear;
- 3 Long press " + " to open the headlight;

4. Display settings

Long press ⏻ to turn the Power on, short press ⏻ to enter setting menu. Press " + " or " - " to choose the menu, and short press ⏻ to select; Press " + " or " - " to choose "exit" to quit;

a. How to set a password

- 1 Enter setting menu to choose the " password"; and then choose the "start password "4-digit password can be set, and each digit is between 0-9. Press ⏻ to confirm.

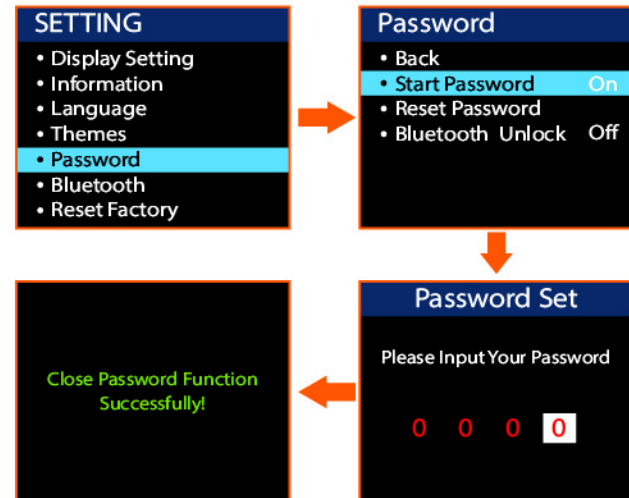

2 Reset password :Enter setting menu to choose the " password"; and then choose the "reset password"; enter the old password and reset the new password;

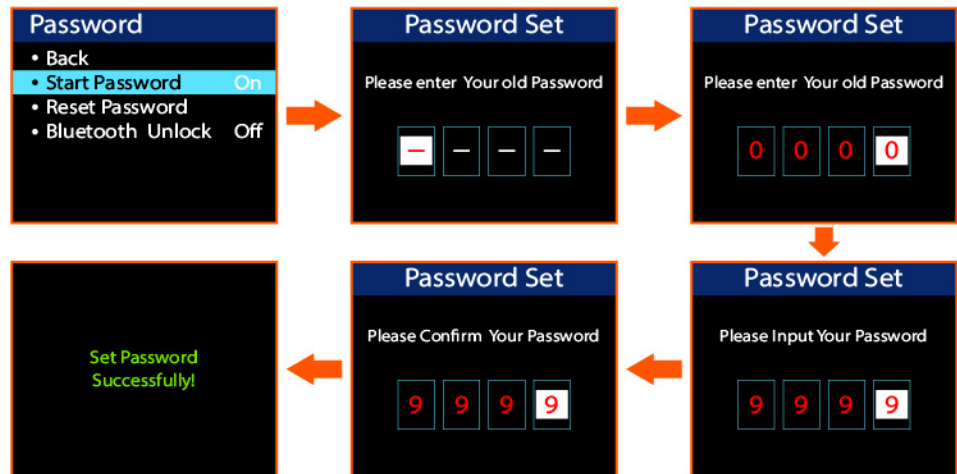

WARNING

Please don't forget the password you set ,otherwise you can not open the bike; in case you forget the password ,the only thing you can do is to contact MIHOGO ;

b. How to build bluetooth connectivity

Enter setting menu to choose the "Bluetooth", Open the downloaded mobile app to scan the QR code for connection.

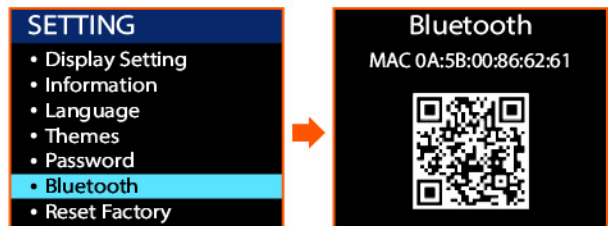

c. Bluetooth lock settings

Enter setting menu to choose the " password"; and then choose the "Bluetooth Unlock", on mean Bluetooth lock open, You can enter the interface when the Bluetooth connected mobile phone is close to you without entering the password ;Do not turn off the display. When your phone is far away from the set Bluetooth range, the instrument will turn off automatically;

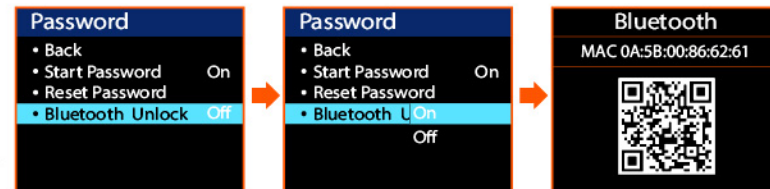

d. BT RSSI Level

Enter setting menu to choose the "BT Rssi Level", Level form 1 to 5 ,level 1 is the shortest Bluetooth connection distance,level 5 is the largest Bluetooth connection distance;



e. Brightness setting

Enter setting menu to choose the "Brightness" there are four level to choose ; 100% is the brightest;

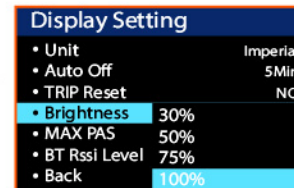

f. Boost Drive setting

Enter setting menu to choose the "Boost Drive", choose "Assistance" means stepping mode, Half throttle no working; choose "Shifter" means half throttle can work, assistance can not work; The factory mode defaults to S&A assistance and throttle both work;

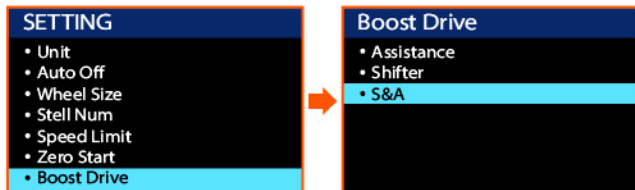

g. Zero start setting

Enter setting menu to choose the "Zero Start", "on" means e-bike can go once you operate Half throttle in any situation under the gear on 1-5; "Off" means e-bike can not go by operate the throttle if your e-bike is no speed under the gear on 1-5;

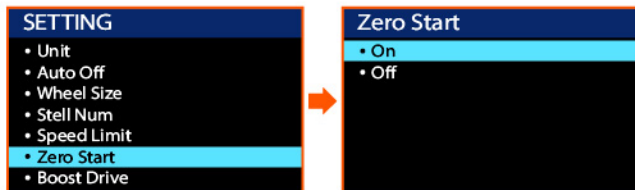

h. Speed Limit setting

Enter setting menu to choose the "Speed Limit", you can choose speed limit from 25KM to 50KM;

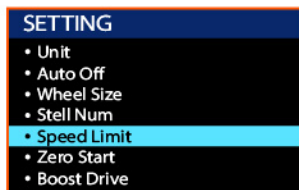

i. Error code

ERROR CODE	FAULT DESCRIPTION
04	The speed control handle does not return to its original position
05	Speed regulating handle fault
07	Overvoltage protection
08	Hall signal line fault of motor
09	Motor phase line fault
10	The temperature in the motor is too high
11	Motor temperature sensor fault
12	Current sensor fault
13	Battery internal temperature fault
14	The temperature in the controller is too high
15	Controller temperature sensor fault
21	Speed sensor failure
30	Communication failure
27	Controller overcurrent
33	Brake detection circuit fault
81	Bluetooth module fault
41	The total battery voltage is too high
42	The total battery voltage is too low
43	Excessive total current

5. Front fork function description

The suspension fork can move up and down to cushion bumps in the riding surface, which can make riding on a rough road or trail smoother and more comfortable. Depending on a rider's weight or preference, preload (suspension fork spring compression) can be adjusted. Adding preload will make the suspension stiffer, which can be better for heavier riders or those who prefer a stiffer, more efficient ride. Subtracting preload will make the suspension softer, which can be best for lighter riders or those who prefer maximum cushioning from bumps in the riding surface.

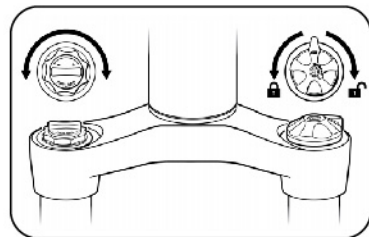

Suspension fork

⚠ WARNING

A low preload setting (for a "softer" ride) can cause your fork to compress when you brake, and the effect will be more dramatic for heavier riders and at higher speeds. If the fork compresses suddenly, that could cause loss of balance or a fall, resulting in serious injury or death.

We recommend you start riding with a higher preload setting. If you want to try a lower preload, practice riding at that setting in a safe location (flat and free of hazards that might require sudden braking) and begin at low to moderate speeds. Depending on a rider's preference, the suspension fork can also be locked out as a rigid fork, which will typically yield higher efficiency while pedaling.

To completely lock the suspension fork, turn the lockout lever, located on the suspension fork, in the direction of the arrow until it stops. To unlock the suspension fork, turn the lever in the other direction until it stops.

To adjust the resistance of the suspension fork, follow these steps:

1. Make sure the lockout lever is unlocked.
2. Turn the preload adjustment knob (located on the suspension fork and labeled "preload"). To make the suspension softer, subtract resistance by turning the preload adjustment knob in the direction of the small "-" on the knob. To make the suspension stiffer, add resistance by turning the preload adjustment knob in the direction of the small "+" on the knob.

5 Electric bicycle parameters

NO.	PERFORMANCE	PARAMETER
1	Product Size: Length, width,height (mm)	1790mm*640mm*1280mm
2	Center distance between front and rear wheels (mm)	1210mm
3	Net weight(kg)	37kg
4	Maximum speed (km / h)	45km/h
5	Max Load(kg)	200kg
6	Battery type	18650 power battery
7	Capacity (Ah)	28.8Ah
8	Nominal voltage (V)	48V
9	Motor type	Permanent magnet
10	Nominal power (W)	750W
11	Under voltage protection value (V)	39±2V
12	Maximum current (A)	22±1A

6 Safe use instructions

1. This charger is dedicated to the company's electric bicycle. It takes care of the battery and effectively improves the battery life.
2. Warning: The user must follow the instructions when charging, otherwise the consequences are at his own risk.
3. Tip: The original charger must be used.
4. Pay attention to the type and applicable voltage of the battery that the charger can charge, and it is strictly forbidden to mix them.
5. When charging, it should be placed in a ventilated environment. It is strictly forbidden to charge in a confined space or in a hot sun and high temperature environment. Do not place the charger in a saddle or tail box for charging. When charging, insert the battery first, then the power supply; after the charging is completed, first cut off the power supply, and then unplug the battery.
6. When the green light is on, the power supply should be cut off in time. Connect the charger to the AC power supply without load for a long time without charging is forbidden.
7. During the charging process, there is a peculiar smell, if the indicator light is abnormal, or the charger casing is overheated, stop charging immediately and repair or replace the charger.
8. During the use and storage of the charger, pay attention to avoid the entry of foreign objects, especially avoid the inflow of water or other liquids, so as not to cause a short circuit inside the charger. Try not to carry the charger with the car. If you really need to carry it, you should put it in the toolbox after absorbing the shock.
9. Do not disassemble or replace the components in the charger by yourself.

10. Every time you use an electric bicycle, you should fully charge it as soon as possible. This is beneficial to prolong the service life of the battery.
11. When the battery is in use, it is prohibited to over-discharge, under-charge, and over-charge, so as not to damage the battery and shorten the service life of the battery. The battery should not be close to open flames or high-temperature heat sources. It is strictly forbidden to expose to the sun in high temperature season to avoid damage to the battery.
12. It is recommended that the battery be deeply discharged regularly, once a generally month is appropriate. That is: long-distance riding until the under-voltage indicator shows that the battery is exhausted or the under-voltage protection device starts to work, at this time, turning off the power for charging, which effectively extend the service life of the battery.
13. If the electric bicycle is not used for a long time, the power supply should be cut off, and the battery should be removed from the car and put away. The battery is best placed in a cool place. It must be recharged once when stored for 20-30 days.
14. The cruising range and charging time will be affected by other objective factors such as driving habits, natural environment, battery life, etc. The parameter configuration table is for reference only. In order to design and use the vehicle safely, MIHOGO has the right to adjust the parameters and configuration content within the legal scope stipulated by law. The specific parameter configuration is subject to the actual sales vehicle.

7 Recommends

Be thoroughly educated about your bike before riding it

Practice riding your bike, braking, shifting gears, and using the throttle and pedal assist systems in a controlled location before venturing into traffic or other risky conditions. The electrical system on your ebike offers various levels of power assistance and lighting for different operating conditions and user preferences. Be sure you understand these features before riding. The throttle should provide smooth acceleration when

gradually applied. If the pedal assistance, throttle, or lighting is functioning abnormally, intermittently, or not at all, please discontinue using your ebike immediately and contact MIHOGO Bikes Product Support for assistance.

Take extreme care getting to know and learning to control the pedal assist and brake systems.

Know and obey all relevant local laws

It is your responsibility to research and understand relevant laws where you ride your bike. Such laws may cover required helmets and safety gear, required lights and reflectors, required hand signals, where you can legally ride a bike (bikes and ebikes may have different restrictions), how fast you can go, what (if any) cargo or passengers you can carry, rider age, and more.

Before using public transportation—buses, trains, etc.—to transport your ebike, check with the relevant transportation authority for any rules governing weight limits, tire widths, lithium-ion batteries, or any other rules that might pertain to ebikes.

When you ride on the road, assume you must, at minimum, follow all of the rules that cars must follow. For additional information regarding traffic and vehicle laws, contact the road traffic authority in your area.