

FIRMAN®

OWNER'S MANUAL PORTABLE GENERATOR



MODEL NUMBER
P03611

Rev Level:00

IMPORTANT: Read all safety precautions and instructions carefully before operating equipment.



Ensure engine is stopped and level before performing any maintenance or service.

Record product information to reference when ordering parts or obtaining warranty coverage.



**DO NOT RETURN TO
STORE!**



CALL US FIRST!
CUSTOMER HOTLINE
1-844-347-6261

FOR QUESTIONS OR SERVICE
INFORMATION

Serial Number: _____

Purchase Date: _____

P/N:336745460 Rev:05

Table of Contents

Introduction	1	Trouble Shooting	23
Safety Precautions	2	Parts Diagram and Parts List	24
Unpacking the Generator	6	Generator Parts Diagram	24
Parts Included	6	Engine Parts Diagram	26
Removal of Shipping Supports	7	Parts List	27
Controls and Features	8	Service Information	28
Generator	8	Warranty	28
Control Panel	9		
Specifications	10		
Add Engine Oil	11		
Low Oil Shutdown	11		
Add Fuel	12		
Operation at High Altitude	12		
Grounding	13		
Connecting to a Building's Electrical System	13		
Operation	14		
Generator Location	14		
Surge Protection	14		
Starting the Generator	15		
Connecting Electrical Loads	16		
Stopping the Engine	16		
Low Oil Shutdown	17		
Do Not Overload Generator	17		
Maintenance And Storage	18		
Maintenance Schedule	18		
Engine Maintenance	19		
Change Engine Oil	19		
Air Filter Maintenance	19		
Spark Plug Maintenance	20		
Cleaning Fuel Strainer	20		
Inspect Muffler and Spark Arrester	20		
Generator Maintenance	21		
Service and Storage	22		

INTRODUCTION











Thank you for purchasing a FIRMAN generator.

This manual contains safety information to make you aware of the hazards and risks associated with generator products and how to avoid them. This generator is designed and intended only for supplying electrical power for operating compatible electrical lighting, appliances, tools and motor loads, and is not intended for any other purpose. It is important that you read and understand these instructions thoroughly before attempting to start or operate this equipment. **Save these original instructions for future reference.**



This manual covers operation and maintenance of the FIRMAN generators. All information in this publication is based on the latest production information available at the time of approval for printing. The manufacturer reserves the right to change, alter or other wise improve the generator and this documentation at any time without prior change.

Important Safety Information

The manufacturer cannot possibly anticipate every possible circumstance that might involve a hazard. The warnings in this manual and the tags and decals affixed to the unit are therefore not all-inclusive. If you use a procedure, work method or operating technique that the manufacturer does not specifically recommend you must satisfy yourself that it is safe for you and others. You must also make sure that the procedure work method or operating technique that you choose does not render the generator unsafe.

SAFETY INFORMATION		
 DANGER	 WARNING	 CAUTION
 Toxic Fumes	 Risk of Electric Shock	 Explosion Hazard
 Fire Hazard	 Rotating Parts Entanglement Hazard	 Hot Surface. Do Not Touch the Surface.
 Kickback	 Operator's Manual	

SAFETY PRECAUTIONS

⚠ DANGER	
Using a generator indoors CAN KILL YOU IN MINUTES . Generator exhaust contains carbon monoxide. This is a poison you cannot see or smell.	
 NEVER use inside a home or garage, EVEN IF doors and windows are open.	 Only use OUTSIDE and far away from windows, doors, and vents.
Avoid other generator hazards. READ MANUAL BEFORE USE.	

⚠ WARNING POISONOUS GAS HAZARD.



Engine exhaust contains carbon monoxide, a poisonous gas that could kill you in minutes. You **CANNOT** smell it, see it, or taste it. Even if you do not smell exhaust fumes, you could still be exposed to carbon monoxide gas.

- Operate this product **ONLY** outside far away from windows, doors and vents to reduce the risk of carbon monoxide gas from accumulating and potentially being drawn towards occupied spaces.
- Install battery-operated carbon monoxide alarms or plug-in carbon monoxide alarms with battery back-up according to the manufacturer's instructions. Smoke alarms cannot detect carbon monoxide gas.
- **DO NOT** run this product inside homes, garages, basements, crawlspaces, sheds, or other partially-enclosed spaces even if using fans or opening doors and windows for ventilation. Carbon monoxide can quickly build up in these spaces and can linger for hours, even after this product has shut off.
- **ALWAYS** place this product downwind and point the engine exhaust away from occupied spaces. If you start to feel sick, dizzy, or weak while using this product, shut it off and get to fresh air **RIGHT AWAY**. See a doctor. You may have carbon monoxide poisoning.

FOR RESIDENTS OF CALIFORNIA

⚠ WARNING: This product and the engine exhaust from this product can expose you to chemicals including CO, which are known to the State of California to cause cancer or cause birth defects and other reproductive harm. For more information, go to www.P65Warnings.ca.gov.

- If you start to feel sick, dizzy or weak while using the portable generator, you may have carbon monoxide poisoning. Get out side to fresh air immediately and call 911 for emergency medical attention. Very high levels of CO can rapidly cause victims to lose consciousness before they can rescue themselves. **DO NOT** attempt to shut off the generator before moving to fresh air. Entering an enclosed space where a generator is or has been running may put you at greater risk of CO poisoning.

CORRECT USAGE

Example location to reduce risk of carbon monoxide poisoning

- ONLY use outside and downwind, far away from windows, doors and vents.
- Direct exhaust **AWAY** from windows, doors, and vents.

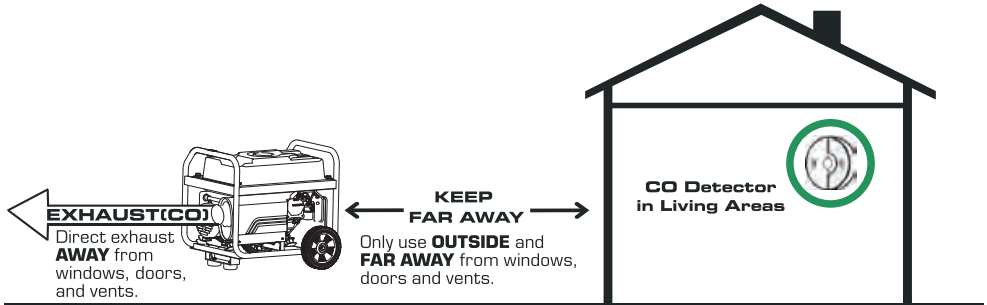

INCORRECT USAGE

Do not operate in any of the following locations:

- Near any door, window or vent
- Garage
- Basement
- Crawl Space
- Living Area
- Attic
- Entry Way
- Porch
- Mudroom

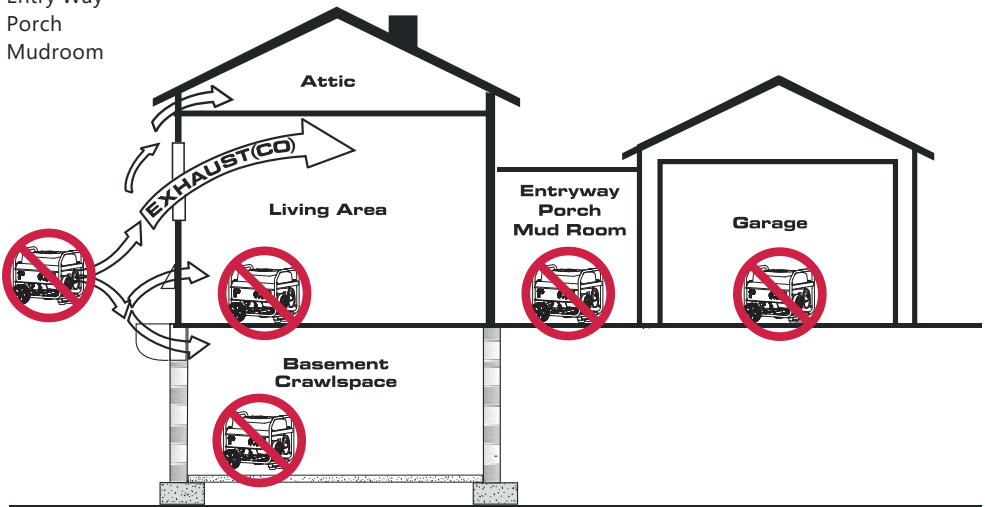

WARNING



Starter cord kickback (rapid retraction) will pull hand and arm toward engine faster than you can let go which could cause broken bones, fractures, bruises, or sprains resulting in serious injury.

- When starting engine, pull cord slowly until resistance is felt and then pull rapidly to avoid kickback.
- **NEVER** start or stop engine with electrical devices plugged in and turned on.

WARNING



Fuel and its vapors are extremely flammable and explosive which could cause burns, fire, or explosion resulting in death or serious injury and/or property damage.

WHEN ADDING OR DRAINING FUEL

- Turn generator engine OFF and let it cool at least 2 minutes before removing fuel cap. Loosen cap slowly to relieve pressure in tank.
- Fill or drain fuel tank outdoors.
- **DO NOT** overfill tank. Allow space for fuel expansion.
- If fuel spills, wait until it evaporates before starting engine.
- Keep fuel away from sparks, open flames, pilot lights, heat, and other ignition sources.
- Check fuel lines, tank, cap, and fittings frequently for cracks or leaks. Replace if necessary.
- **DO NOT** light a cigarette or smoke.

WHEN STARTING EQUIPMENT

- Ensure spark plug, muffler, fuel cap, and air cleaner are in place.
- **DO NOT** crank engine with spark plug removed.

WHEN OPERATING EQUIPMENT

- **DO NOT** operate this product inside any building, carport, porch, mobile equipment, marine applications, or enclosure.
- **DO NOT** tip engine or equipment at angle which causes fuel to spill.
- **DO NOT** stop engine by moving choke control to "Start" position.

WHEN TRANSPORTING, MOVING OR REPAIRING EQUIPMENT

- Transport/move/repair with fuel tank EMPTY or with fuel shutoff valve OFF.
- **DO NOT** tip engine or equipment at angle which causes fuel to spill.
- Disconnect spark plug wire.

WHEN STORING FUEL OR EQUIPMENT WITH FUEL IN TANK

- Store away from furnaces, stoves, water heaters, clothes dryers, or other appliances that have pilot light or other ignition source because they could ignite fuel vapors.

WARNING

- This generator does not meet U. S. Coast Guard Regulation 33CFR-183 and should not be used on marine applications.
- Failure to use the appropriate U. S. Coast Guard approved generator could result in death or serious injury and/or property damage.

WARNING



Generator voltage could cause electrical shock or burn resulting in death or serious injury.

- Use approved transfer equipment, suitable for the intended use, to prevent backfeed by isolating generator from electric utility workers.

- When using generator for backup power, notify utility company.
- Use a ground fault circuit interrupter (GFCI) in any damp or highly conductive area, such as metal decking or steel work.
- **DO NOT** touch bare wires or receptacles.
- **DO NOT** use generator with electrical cords which are worn, frayed, bare or otherwise damaged.
- **DO NOT** operate generator in the rain or wet weather.
- **DO NOT** handle generator or electrical cords while standing in water, while barefoot, or while hands or feet are wet.
- **DO NOT** allow unqualified persons or children to operate or service generator.

WARNING



Exhaust heat/gases could ignite combustibles, structures or damage fuel tank causing a fire, resulting in death or serious injury and/or property damage.

Contact with muffler area could cause burns resulting in serious injury.

- **DO NOT** touch hot parts and **AVOID** hot exhaust gases.
- Allow equipment to cool before touching.
- It is a violation of California Public Resource Code, Section 4442, to use or operate the engine on any forest-covered, brush-covered, or grass-covered land unless the exhaust system is equipped with a spark arrester, as defined in Section 4442, maintained in effective working order. Other states or federal jurisdictions may have similar laws. Contact the original equipment manufacturer, retailer, or dealer to obtain a spark arrester designed for the exhaust system installed on this engine.
- Replacement parts must be the same and installed in the same position as the original parts.

WARNING



Unintentional sparking could cause fire or electric shock resulting in death or serious injury.

WHEN ADJUSTING OR MAKING REPAIRS TO YOUR GENERATOR

- Disconnect the spark plug wire from the spark plug and place the wire where it cannot contact spark plug.

WHEN TESTING FOR ENGINE SPARK

- Use approved spark plug tester.
- **DO NOT** check for spark with spark plug removed.

WARNING



Starter and other rotating parts could entangle hands, hair, clothing, or accessories resulting in serious injury.

- **NEVER** operate generator without protective housing or covers.
- **DO NOT** wear loose clothing, jewelry or anything that could be caught in the starter or other rotating parts.
- Tie up long hair and remove jewelry.

CAUTION

Excessively high operating speeds could result in minor injury. Excessively low operating speeds impose a heavy load.

- **DO NOT** tamper with governor spring, links or other parts to increase engine speed. Generator supplies correct rated frequency and voltage when running at governed speed.
- **DO NOT** modify generator in any way.

NOTE:

Exceeding generators wattage/amperage capacity could damage generator and/or electrical devices connected to it.

- **DO NOT** exceed the generator's wattage amperage capacity.
- Start generator and let engine stabilize before connecting electrical loads.
- Connect electrical loads in OFF position, then turn ON for operation.
- Turn electrical loads OFF and disconnect from generator before stopping generator.

NOTE:

Improper treatment of generator could damage it and shorten its life.

- Use generator only for intended uses.
- If you have questions about intended use, ask dealer or contact local service center.
- Operate generator only on level surfaces.
- DO NOT expose generator to excessive moisture, dust, dirt, or corrosive vapors.
- DO NOT insert any objects through cooling slots.
- If connected devices overheat, turn them off and disconnect them from generator.
- Shut off generator if:
 - Electrical output is lost.
 - Equipment sparks, smokes, or emits flames.
 - Unit vibrates excessively.

WARNING

Medical and Life Support Uses.

- In case of emergency, call 911 immediately.
- NEVER use this product to power life support devices or life support appliances.
- NEVER use this product to power medical devices or medical appliances.
- Inform your electricity provider immediately if you or anyone in your household depends on electrical equipment to live.
- Inform your electrical provider immediately if a loss of power would cause you or anyone in your household to experience a medical emergency.

UNPACKING THE GENERATOR

- Open carton and Remove packaging materials.
- Remove generator, accessories boxes, and literature from carton. If any items are missing or damaged, contact our product service department at 1-844-347-6261.

Parts Included

Your gasoline powered generator ships with the following parts:

1. Engine Oil(Bottle)	1
2. Oil Funnel	1
3. Wrench for Spark plug	1
4. Double Open wrench (10mm & 12mm)	2
5. Manual	1
6. Quick Reference Guide	1

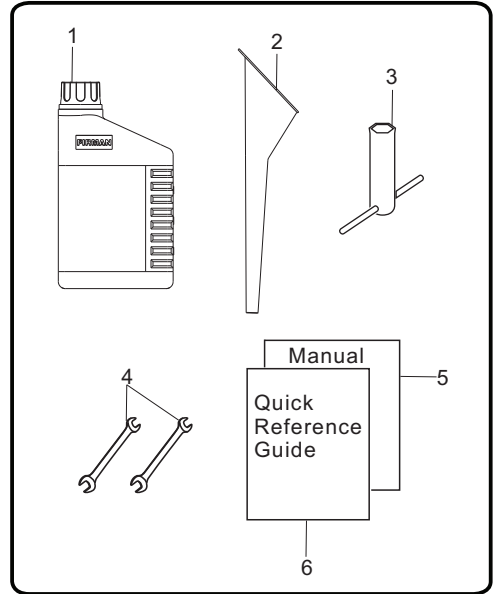

REMOVAL OF SHIPPING SUPPORTS

Before you can run your new generator, follow these simple instructions:

The following items must be removed before running your new generator. In order to protect your generator these items have been added to ensure safe delivery of your new generator.

⚠ CAUTION

Failure to remove these items can result in damage to your generator, possible Personal injury and void your warranty.

Refer to the following instructions and pictures to remove the attached engine support brackets (red) under the engine.

1. Before filling the engine oil, tip the generator back onto its recoil frame end as indicated in this picture. Place the generator on the flattened cardboard box or other protective surface.

2. Remove the indicated bolts and nuts from the red engine support brackets. You may use the appropriate wrenches provided.

3. You may discard these brackets, as they are no longer required for normal operation of your generator.

Your generator is now ready for use. Refer to your owner's manual for proper oil fill and startup instructions.

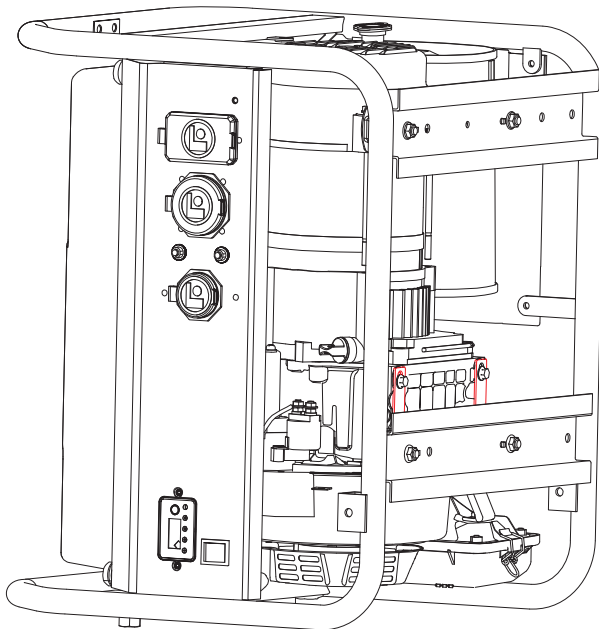

Supplied wrenches

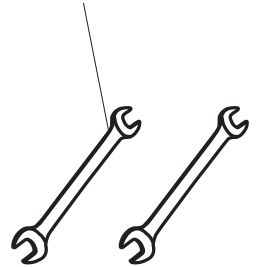

Engine Support Brackets (red color)

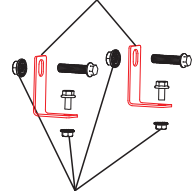

Remove these 4 nuts & bolts as indicated.

CONTROLS AND FEATURES

Generator

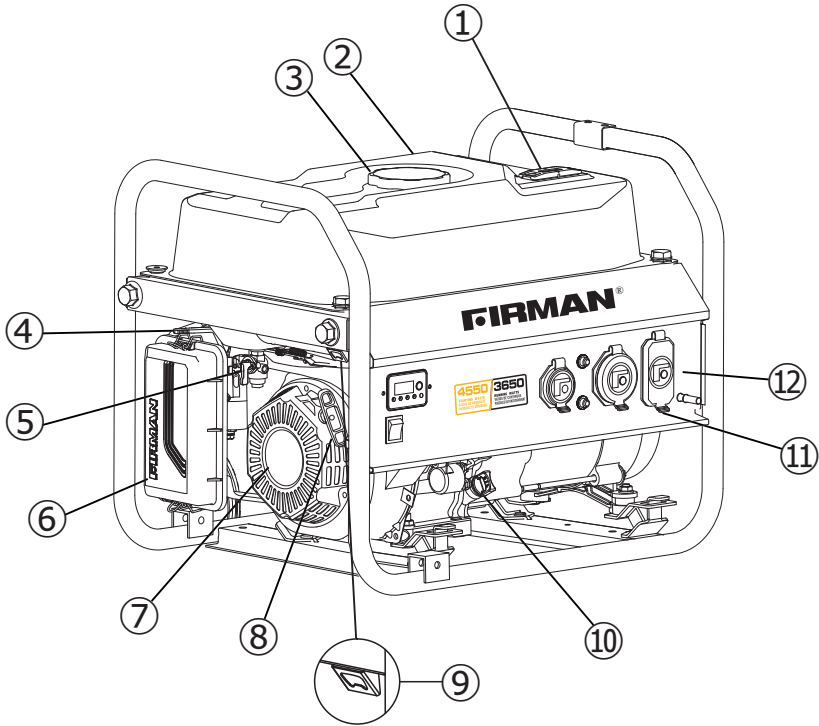

- 1- Fuel Gauge
- 2- 5.0 Gallon Capacity Fuel Tank
- 3- Fuel Cap
- 4- Choke Lever
- 5- Fuel Valve
- 6- Air Filter
- 7- 208cc FIRMAN OHV Engine
- 8- Recoil Starter

- 9- Bottle Opener
- 10 - Oil Filler Cap
- 11 - Outlet Cover
- 12 - Control Panel

NOTE:

This model ships from factory **without wheel kit**. To find out about wheel kit and other accessories, please visit our website www.firmangenerators.com or call customer service 1-844-347-6261.

*We are always working to improve our products. Therefore, the enclosed product may differ slightly from the image on this page.

Control Panel

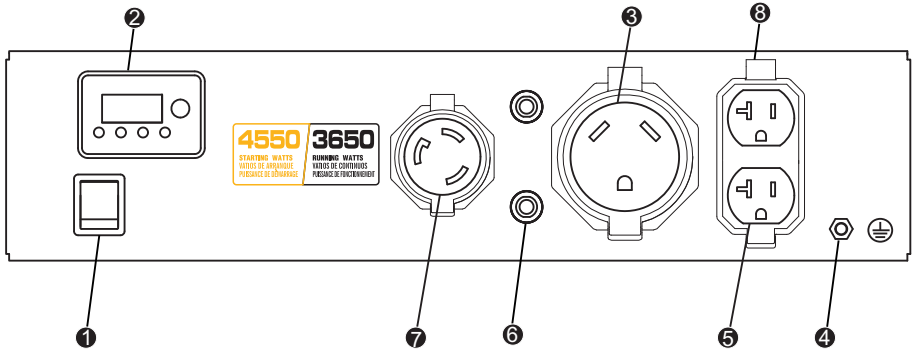

NOTE:

Total power drawn from all receptacles must not exceed the name plate rating.

- ① **Engine Switch** – Flip the switch to the “ON”(I) position and pull the recoil starter to start the generator. Turn to the “OFF”(O) position to turn off the generator.
- ② **4-1 Data-Minder(Multi-Meter)** – Push the SELECT button to show the Voltage, Hertz and running hours. If the low oil indicator is lit, check the oil level.

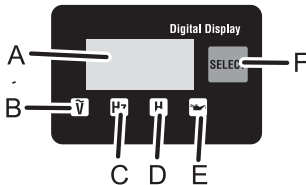

- A - Digital display
- B - AC voltage indicator
- C - Frequency indicator
- D - Hour indicator
- E - Low oil indicator
- F - Select button

- ③ **120V, 30A RV** (NEMA TT-30R)
Maximum full load 30 Amp current may be drawn from this 120 Volt receptacle.
- ④ **Ground Terminal** – Consult an electrician for local grounding regulations.
- ⑤ **120V, 20A Duplex** – (NEMA 5-20R) 20 Amp of current may be drawn from this 120 Volt receptacle.
- ⑥ **Circuit Breakers** – The receptacles are protected by an AC circuit protector. If the generator is overloaded or an external short circuit occurs the circuit protector will trip. If this occurs, disconnect all electrical loads and try to determine the cause of the problem before attempting to use the generator again. If overloading causes the circuit protector to trip, reduce the load.
Note: Continuous tripping of the circuit protector may cause damage to generator or equipment. The circuit protector may be reset by pushing the button of the protector.
- ⑦ **120V, 30A Twist-Lock** (NEMA L5-30R)
Maximum full load 30 Amp current may be drawn from this 120 Volt receptacle.
- ⑧ **Outlet Cover** - Protect the receptacles from dust and debris.

SPECIFICATIONS

Model	P03611
Starting Watts	4550
Running Watts	3650
Rated AC Voltage	120V
Rated Frequency	60Hz
Phase	Single
Voltage Regulator	AVR
Power Factor	1
Total Harmonic Distortion(THD)	Standard
Alternator Type	Brushed
Engine	FIRMAN
Engine Type	Single Cylinder, 4-Stroke OHV Air Cooled
Displacement	208cc
Low Oil Shutdown	Yes
Ignition System	Breakless Ignition Type, Flywheel Magneto
Starting System	Recoil
Fuel	Unleaded Automotive Gasoline
Capacity Fuel Tank	5.0 Gallon
Lubricating Oil Capacity	20.3 oz(0.6L)
Carburetor Type	Float
Air Cleaner	Polyurethane Type
P.T.O. Shaft Rotation	Counter Clockwise (Facing P.T.O.)
Oil Type	See "Add Engine Oil" Section
AC Grounding System	Neutral Bonded To Frame

AN IMPORTANT MESSAGE ABOUT TEMPERATURE:

Your Firman Power Equipment product is designed and rated for continuous operation at ambient temperatures up to 40°C (104°F). When your product is needed, your product may be operated at temperatures ranging from -15°C (5°F) to 50°C (122°F) for short periods. If the product is exposed to temperatures outside this range during storage, it should be brought back within this range before operation. In any event, the product must always be operated outdoors, in a well-ventilated area and away from doors, windows and other vents.

- When operated above 77°F(25°C) there may be a decrease in power.
- Maximum wattage and current are subject to and limited by such factors as fuel BTU content ambient temperature, altitude, engine condition and etc. Maximum power decreases about 3.5% for each 1,000 feet above sea level; and will also decrease about 1% for each 10°F(6°C) above 60°F(16°C) ambient temperature.

Add Engine Oil

CAUTION

DO NOT attempt to crank or start the engine before it has been properly filled with the recommended type and amount of oil. Damage to the generator as a result of failure to follow these instructions will void your warranty.

NOTE:

The recommended oil type is 10W-30 automotive oil. However outdoor temperatures will determine the space proper oil viscosity for the engine. Use the chart to select the best for the outdoor temperature range expected.

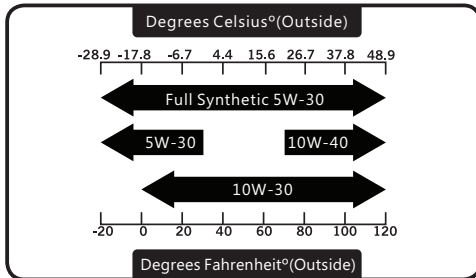

1. Place generator on a flat, level surface.
2. Clean area around oil fill and remove yellow oil fill cap/dipstick.
3. Wipe dipstick clean.

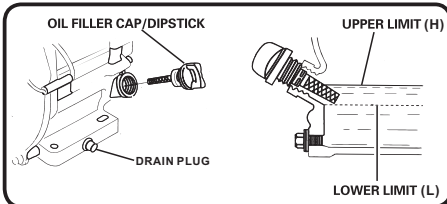
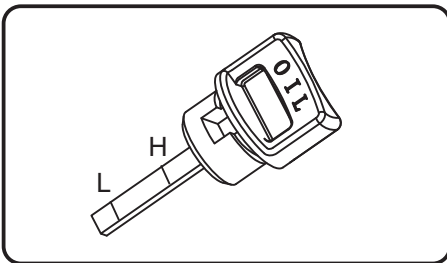

4. Using oil funnel, slowly pour contents of provided oil bottle into oil fill opening to the "H" mark on dipstick. Be careful do not overfill. Overfilling with oil could cause the engine to not start or hard starting.

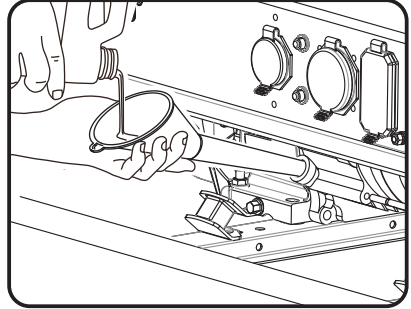

5. Replace oil fill cap/dipstick and fully tighten.
6. Oil level should be checked prior to each use or at least every 8 hours of operation. Keep oil level maintained.

CAUTION

The engine is equipped with a low oil shut-off and will stop when the oil level in the crankcase falls below the threshold level.

NOTE:

We consider the first 5 hours of run time to be the break-in period for the unit. During the break in period stay at or below 50% of the running watt rating and vary the load occasionally to allow stator windings to heat and cool. Adjusting the load will also cause engine speed to vary and help seat piston rings.

Low oil shutdown

The unit is equipped with a low oil shutdown. If the oil level becomes lower than required, the sensor will activate a warning device or stop the engine.

If generator shuts off and the oil level is within specifications, check to see if generator is sitting at an angle that forces oil to shift. Place on an even surface to correct this. If engine fails to start, the oil level may not be sufficient to deactivate low oil level switch. Make sure the sump is completely full of oil.

Add Fuel

Fuel must meet these requirements:

- Clean, fresh, unleaded gasoline.
- Use regular UNLEADED gasoline with the generator engine with a minimum 87 octane / 87 AKI (91 RON).

For high altitude use, see "Operation at High Altitude".

- Do not use gasoline with more than 10% alcohol such as E85 or ethanol.

NOTE: Avoid generator damage.

Failure to follow Operator's Manual for fuel recommendations voids warranty.

- DO NOT use unapproved gasoline such as E85.
- DO NOT mix oil in gasoline.
- DO NOT modify engine to run on alternate fuels.

WARNING



Fuel and its vapors are extremely flammable and explosive which could cause burns, fire or explosion resulting in death, serious injury and/or property damage.

WHEN ADDING FUEL

- Fill fuel tank outdoors.



DO NOT overfill tank. Allow space for fuel expansion. If the tank is overfilled, fuel can overflow onto a hot engine and cause fire or explosion. Wipe up any spilled fuel immediately.

- If fuel spills, wait until it evaporates before starting engine.
- Keep fuel away from sparks, open flames, pilot lights, heat, and other ignition sources.
- Check fuel lines, tank, cap and fittings frequently for cracks or leaks. Replace if necessary.



DO NOT light a cigarette or smoke when filling the fuel tank.

1. Clean area around fuel fill cap, remove cap.
2. Slowly add unleaded fuel to fuel tank. Be careful not to fill above the red fuel level indicator. This allows adequate space for fuel expansion.
3. Install fuel cap and let any spilled fuel evaporate before starting engine or wipe up any spilled gasoline.

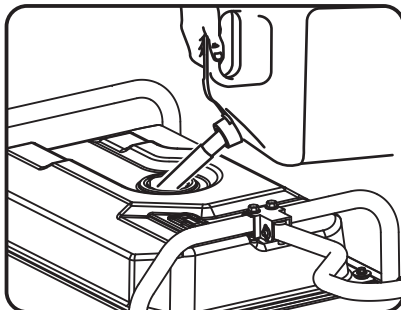

CAUTION

- Slowly add unleaded gasoline to fuel tank.
- Do not overfill tank.
- Do not fill above the red line indicator. This will allow expansion in hot weather and prevent overflow.



IMPORTANT: It is important to prevent gum deposits from forming in fuel system parts such as the carburetor, fuel hose or tank during storage. Alcohol-blended fuels (called gasohol, ethanol or methanol) can attract moisture, which leads to separation and formation of acids during storage. Acidic gas can damage the fuel system of an engine while in storage. To avoid engine problems, the fuel system should be emptied before storage of 30 days or longer. See the " Long Term Storage" section. Never use engine or carburetor cleaner products in the fuel tank as permanent damage may occur.

Operation at High Altitude

At altitudes over 5,000 feet (1524 meters), a minimum 85 octane / 85 AKI (89 RON) gasoline is acceptable.

The density of air at high altitude is lower than at sea level. Engine power is reduced as the air mass and air-fuel ratio decrease. Engine power and generator output will be reduced approximately 3.5% for every 1000 feet of elevation above sea level. This is a natural trend and cannot be changed by adjusting the engine. At high altitudes

increased exhaust emissions can also result due to the increased enrichment of the air fuel ratio.

Other high altitude issues can include hard starting, increased fuel consumption and spark plug fouling. To alleviate high altitude issues other than the natural power loss, **FIRMAN** can provide a high altitude carburetor main jet. The alternative main jet and installation instructions can be obtained by contacting Customer Support. Installation instructions are also available in the Technical Bulletin area of the FIRMAN internet site. The part number and recommended minimum altitude for the application of the high altitude carburetor main jet is listed in the table below.

	208cc	Altitude
Altitude main jet 1	335717002	3000-6000Feet
Altitude main jet 2	335717003	6000-8000Feet

WARNING

Operation using the alternative main jet at elevations lower than the recommended minimum altitude can damage the engine. For operation at lower elevations, the standard main jet must be used. Operating the engine with the wrong engine configuration at a given altitude may increase its emissions and decrease fuel efficiency and performance.

Grounding

The National Electric Code requires your generator must be properly connected to an appropriate ground to help prevent electric shock.

WARNING



Failure to properly ground the generator can result in electric shock.

A ground terminal connected to the frame of the generator has been provided on the control panel. For remote grounding, connect a length of heavy gauge (12 AWG minimum) copper wire between the generator ground terminal and a copper rod driven into the ground. We strongly recommend that you consult with a qualified electrician to ensure compliance with local electrical codes.

THERE IS A PERMANENT CONDUCTOR BETWEEN THE GENERATOR (STATOR WINDING) AND THE FRAME.

Connecting to a Building's Electrical System

Connections for standby power to a building's electrical system must be made by a qualified electrician. The connection must isolate the generator power from utility power or other alternative power sources and must comply with all applicable laws and electrical codes.

WARNING



Generator voltage could cause electrical shock or burn resulting in death or serious injury.

- Use approved transfer equipment to prevent backfeed by isolating generator from electric utility workers.
- When using generator for backup power, notify utility company.
- Use a ground fault circuit interrupter (GFCI) in any damp or highly conductive area, such as metal decking or steel work.
- DO NOT touch bare wires or receptacles.
- DO NOT use generator with electrical cords which are worn, frayed, bare or otherwise damaged.
- DO NOT operate generator in the rain or wet weather.
- DO NOT handle generator or electrical cords while standing in water, while barefoot, or while hands or feet are wet.
- DO NOT allow unqualified persons or children to operate or service generator.

OPERATION

Generator Location

WARNING

Make sure you review each warning in order to prevent fire hazard.

- Keep area clear of inflammables or other hazardous materials.
- Select a site that is dry, well ventilated and protected from the weather.
- Keep exhaust pipe clear of foreign objects.
- Keep generator away from open flame.
- Keep generator on a stable and level surface.

CAUTION

Tilting can cause fuel spillage.

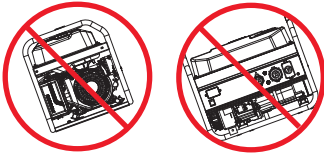

- Do not block generator air vents with paper or other material.

DANGER

Using a generator indoors **CAN KILL YOU IN MINUTES.**

Generator exhaust contains carbon monoxide. This is a poison you cannot see or smell.



NEVER use inside a home or garage, **EVEN IF** doors and windows are open.



Only use OUTSIDE and far away from windows, doors, and vents.

Avoid other generator hazards.
READ MANUAL BEFORE USE.

WARNING

POISONOUS GAS HAZARD.



Engine exhaust contains carbon monoxide, a poisonous gas that could kill you in minutes. You **CANNOT** smell it, see it, or taste it. Even if you do not smell exhaust fumes, you could still be exposed to carbon monoxide gas.

- Operate this product **ONLY** outside far away from windows, doors and vents to reduce the risk of carbon monoxide gas from accumulating and potentially being drawn towards occupied spaces.
- Install battery-operated carbon monoxide alarms or plug-in carbon monoxide alarms with battery back-up according to the manufacturer's instructions. Smoke alarms cannot detect carbon monoxide gas.
- **DO NOT** run this product inside homes, garages, basements, crawlspaces, sheds, or other partially-enclosed spaces even if using fans or opening doors and windows for ventilation. Carbon monoxide can quickly build up in these spaces and can linger for hours, even after this product has shut off.
- **ALWAYS** place this product downwind and point the engine exhaust away from occupied spaces. If you start to feel sick, dizzy, or weak while using this product, shut it off and get to fresh air **RIGHT AWAY**. See a doctor. You may have carbon monoxide poisoning.

Surge Protection

CAUTION

Voltage fluctuation may impair the proper functioning of sensitive electronic equipment.

Electronic devices, including computers and many programmable appliances use components that are designed to operate within a narrow voltage range and may be affected by momentary voltage fluctuations. While there is no way to prevent voltage fluctuations, you can take steps to protect sensitive electronic equipment.

Install UL1449, CSA-listed, plug-in surge suppressors on the outlets feeding your sensitive equipment. Surge suppressors come in single- or multi-outlet styles. They're designed to protect against virtually all short-duration voltage fluctuations.

Starting the Generator

1. Before starting the generator, check for loose or missing parts and for any damage which may have occurred during shipment.
2. Check oil level and fuel.

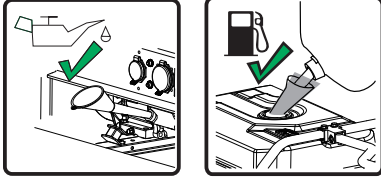

3. Disconnect all electrical loads from the generator. Never start or stop the generator with electrical devices plugged in or turned on.

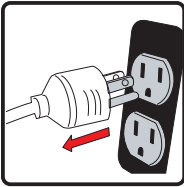

4. Turn the fuel valve to the "ON" (I) position.



5. Flip the engine switch to the "ON" (I) position.



6. Move the choke lever to the "START" position.

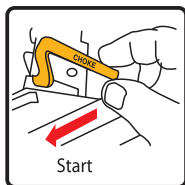

7. Pull the starter cord slowly until resistance is felt and then pull rapidly.

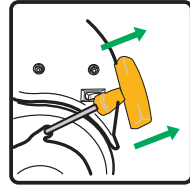

8. Do not over-choke. As soon as engine starts and warms up, move the choke lever to the "RUN" position.

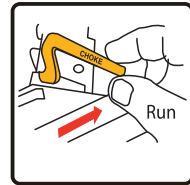

9. Allow generator to run at no load for few minutes upon each initial start-up to permit engine and generator to stabilize.

⚠ WARNING



Starter cord kickback (rapid retraction) will pull hand and arm toward engine faster than you can let go which could cause broken bones, fractures, bruises, or sprains resulting in serious injury.

When starting engine, pull cord slowly until resistance is felt and then pull rapidly to avoid kickback.

NOTE:

Keep choke lever in "START" position for only 1 pull of the recoil starter. After first pull, move choke lever to the "RUN" position for up to the next 3 pulls of the recoil starter. Too much choke leads to sparkplug fouling/engine flooding due to the lack of incoming air. This will cause the engine not to start.

NOTE:

If engine starts after 3 pulls but fails to run, or if unit shuts down during operation, make sure unit is on a level surface and check for proper oil level in crankcase. This unit may be equipped with a low oil protection device. If so, oil must be at proper level for engine to start.

Connecting Electrical Loads

This unit has been pretested and adjusted to handle its full capacity. Before starting the generator, disconnect all load. Apply load only after generator is running. Voltage is regulated via the engine speed adjusted at the factory for correct output. Readjusting will void warranty.

CAUTION

When applying a load, do not exceed the maximum wattage rating of the generator when using one or more receptacles. Also, do not exceed the amperage rating of any one receptacle.

Do not apply heavy electrical load during break-in period (the first five hours of operations).

1. Let engine stabilize and warm up for a few minutes after starting.
2. Ensure circuit breaker on control panel is in on position.
3. Plug in and turn on the desired 120 or 240 Volt AC, single phase, 60Hz electrical loads. It is better to attach the item with largest load first.

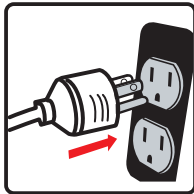

NOTE:

Connecting a generator to your electric utility company's power lines or to another power source may be against the law. In addition this action, if done incorrectly, could damage your generator and appliances and could cause serious injury or even death to you or a utility worker who may be working on nearby power lines. If you plan to run a portable electric generator during an outage, please notify your electric utility company immediately and remember to plug your appliances directly into the generator. Do not plug the generator into any electric outlet in your home. Doing so could create a connection to the utility company power lines. You are responsible for ensuring that your generator's electricity does not feed back into the electric utility power lines. If the generator will be connected to a building

electrical system, consult your local utility company or a qualified electrician. Connections must isolate generator power from utility power and must comply with all applicable laws and codes.

Stopping the Engine

1. Turn off and remove entire electrical loads. Never start or stop the generator with electrical devices plugged in or turned on.

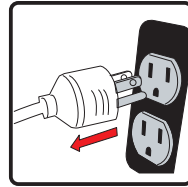

Let the generator run at no-load for two minutes to stabilize internal temperatures of the engine and generator.

2. Press the engine switch to the "OFF" (O) position.

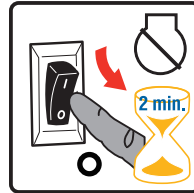

Do not leave the generator until it has completely stopped.

3. Turn the fuel valve to the "OFF" (O) position.

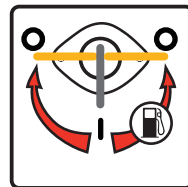

If a cover is used, do not install until unit has cooled.

WARNING



Fuel and its vapors are extremely flammable and explosive which could cause burns, fire or explosion resulting in death, serious injury and/or property damage.

DO NOT stop engine by moving choke control to "START" position.

Important: Always ensure that the Fuel Valve and the Engine Switch are in the "OFF" position when the engine is not in use.

NOTE:

If the engine will not be used for a period of two weeks or longer, please see the Storage section for proper engine and fuel storage.

Low Oil Shutdown

If the engine oil drops below a preset level, an oil switch will stop the engine. Check oil level with dipstick.

If oil level is between LOW and HIGH mark on dipstick:

1. DO NOT try to restart the engine.
2. Contact an Authorized FIRMAN Service Dealer.
3. DO NOT operate engine until oil level is corrected.

If oil level is below LOW mark on dipstick:

1. Add oil to bring level to HIGH mark.
2. Restart engine and if the engine stops again a low oil condition may still exist. DO NOT try to restart the engine.
3. Contact an Authorized FIRMAN Service Dealer.
4. DO NOT operate engine until oil level is corrected.

Do Not Overload Generator

Overloading a generator in excess of its rated wattage capacity can result in damage to the generator and to connected electrical devices.

To prolong the life of your generator and attached devices, follow these steps to add electrical load:

1. Start the generator with no electrical load attached.
2. Allow the engine to run for several minutes to stabilize.
3. Plug in and turn on the first item. It is best to attach the item with the largest load first.
4. Allow the engine to stabilize.
5. Plug in and turn on the next item.
6. Allow the engine to stabilize.
7. Repeat steps 5-6 for each additional item.

MAINTENANCE AND STORAGE

MAINTENANCE SCHEDULE

ITEM	NOTES	Daily(Before operation)	Initial 25 hours	Every 50 hours	Every 100 hours (or annual)	Every 250 hours
Spark Plug	Check condition. Adjust gap and clean. Replace if necessary.				✓	
Engine Oil	Check oil level.	✓				
	Replace.		✓		✓	
Air Filter	Clean, replace if necessary.			✓		
Fuel Filter	Clean fuel filter and fuel tank strainer. Replace if necessary.				✓	
Fuel Line	Check fuel hose for cracks or other damage. Replace if necessary.	✓				
Exhaust System	Check for leakage. Retighten or replace gasket if necessary.	✓				
	Check spark arrester screen. Clean/Replace if necessary.				✓	
Engine	Check adjust valve clearance.*					✓
	Clean combustion chamber.*					✓
Fittings/ Fasteners	Check. Replace if necessary.				✓	

* To be performed by knowledgeable/experienced owner or by authorized service center.

General Recommendations

Regular maintenance will improve the performance and extend the life of the generator. See any authorized dealer for service.

The generator's warranty does not cover items that have been subjected to operator abuse or negligence. To receive full value from the warranty, the operator must maintain the generator as instructed in this manual.

Some adjustments will need to be made periodically to properly maintain your generator.

All service and adjustments should be made at least once each season. Follow the requirements in the Maintenance Schedule chart above.

Notice Once a year you should clean or replace the spark plug and replace the air filter. New spark plugs and clean air filter assure proper fuel-air mixture and help your engine run better and last longer.

ENGINE MAINTENANCE

To prevent accidental starting, remove and ground spark plug wire before performing any service.

Change Engine Oil

Change engine oil every 100 hours.
(for a new engine, change oil after 25 hours.)

If you are using your generator under extremely dirty or dusty conditions, or in extremely hot weather, change the oil more often.

CAUTION

Avoid prolonged or repeated skin contact with used motor oil.

- Used motor oil has been shown to cause skin cancer in certain laboratory animals.
 - Thoroughly wash exposed areas with soap and water.
- (a) Drain oil by removing the drain plug and the oil filler cap while the engine is warm.

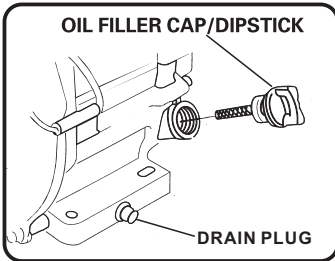

NOTE:

Please use a container to dispose of the oil at an approved recycling center.

(b) Reinstall the drain plug and fill the engine with oil until it reaches the HIGH(H) level on the oil filler cap.

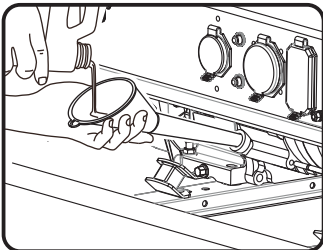

- Use fresh and high quality lubricating oil to the specified quantity.
If contaminated or deteriorated oil is used or the quantity of the engine oil is not sufficient, engine damage will result and its life will be greatly shortened.

Air Filter Maintenance

Maintaining an air filter in proper condition is very important. Dirt induced through improperly installed, improperly serviced, or inadequate elements damages and wears out engines. Always keep the element clean.

(a) Take out the air cleaner, clean it well in kerosene and dry it.

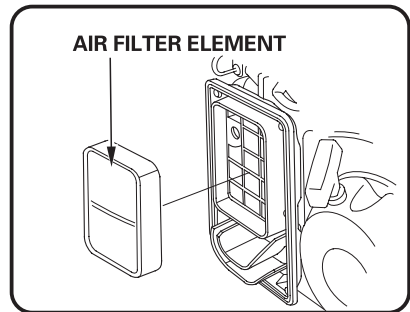
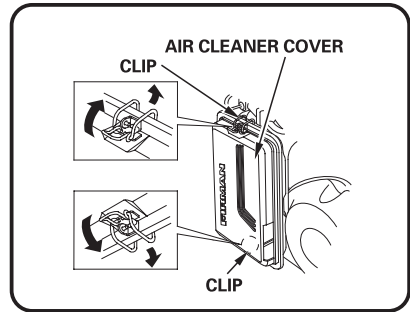

(b) After wetting the element with clean engine oil squeeze it tight by hand.

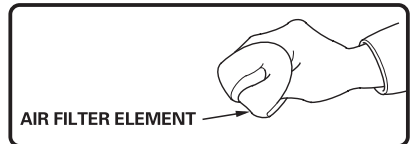

(c) Lastly, put the element in the case and install it securely.

Spark Plug Maintenance

Changing the spark plug will help your engine to start easier and run better.

- Remove the spark plug cap.
- Remove spark plug using provided wrench.

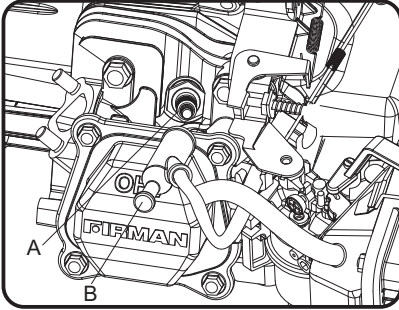

A- Spark plug
B- Spark plug cap

- Inspect spark plug for damage and clean with a wire brush before reinstalling
- Adjust the electrode gap to 0.7 to 0.8 mm (0.028" to 0.031").
- Seat spark plug in position and thread by hand to prevent cross threading.
- Tighten plug with provided wrench and put the cap back on spark plug.

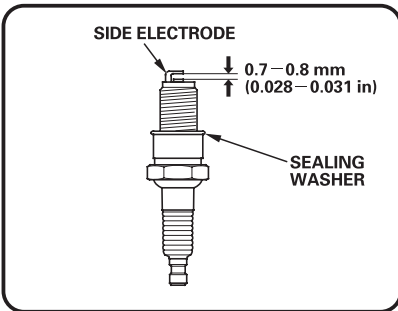

SPARK PLUG: TORCH F6RTC
NGK BPR6ES
CHAMPION RN9YC equivalent.

Maintenance Valve Clearance

- Intake: 0.1 - 0.15 mm (0.004 - 0.006 in.)
 - Exhaust: 0.1 - 0.15 mm (0.004 - 0.006 in.)
- To be performed by knowledgeable/experienced owner or by authorized service center.

Cleaning Fuel Strainer

Dirt and water in the fuel are removed by the fuel strainer.

- Remove the strainer cup and throw away water and dirt.
- Clean the screens and strainer cup with gasoline.
- Tightly fasten the cup to main body, making sure to avoid fuel leak.

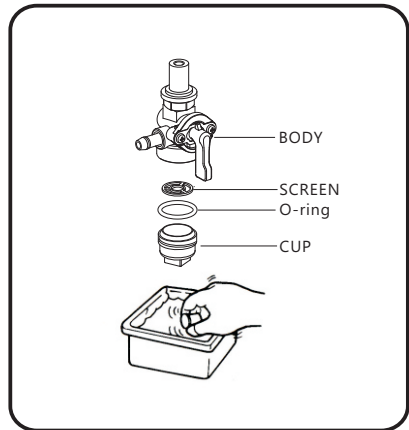

Inspect Muffler and Spark Arrester

Inspect the muffler for cracks, corrosion, or other damage. Remove the spark arrester, if equipped, and inspect for damage or carbon blockage. If replacement parts are required, make sure to use only original equipment replacement parts.

⚠ WARNING



Exhaust heat/gases could ignite combustibles, structures or damage fuel tank causing a fire, resulting in death or serious injury and/or property. Contact with muffler area could cause burns resulting in serious injury.

- **DO NOT** touch hot parts and **AVOID** hot exhaust gases.
- Allow equipment to cool before touching.
- Keep at least 5 feet (1.5 m) of clearance on all sides of generator including overhead.
- Replacement parts must be the same and installed in the same position as the original parts.

Clean or replace spark arrester as follows:

Depending on the type fuel used, the type and amount of lubricant used, and/or your operating conditions, the exhaust part and muffler may become blocked with carbon deposits. If you notice power loss, you may need to remove these deposits to restore performance.

1. Allow the engine to cool completely before servicing the spark arrester.
2. Remove the screws securing the spark arrester in place and then remove it from the muffler.

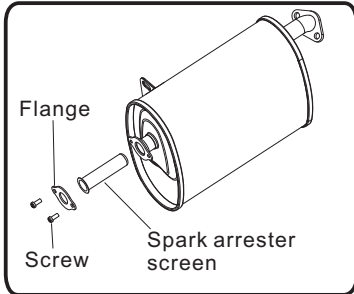

3. Carefully remove the carbon deposits from the spark arrester screen with a wire brush.

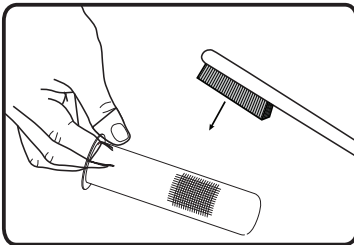

4. Replace the spark arrester if it is damaged.
5. Position the spark arrester in the muffler and attach with the screws.

⚠ CAUTION

Failure to clean the spark arrester will result in degraded engine performance.

GENERATOR MAINTENANCE

Make certain that the generator is kept clean and stored properly. Only operate the unit on a flat, level surface in a clean, dry operating environment. **DO NOT** expose the unit to extreme conditions, excessive dust, dirt, moisture or corrosive vapours.

⚠ CAUTION

DO NOT use a garden hose to clean the generator. Water can enter the generator through the cooling slots and damage the generator windings.

Use a damp cloth to clean exterior surfaces of the generator.

Use a soft bristle brush to remove dirt and oil. Use an air compressor (25 PSI) to clear dirt and debris from the generator.

Inspect all air vents and cooling slots to ensure that they are clean and unobstructed.

SERVICE AND STORAGE

Infrequent Service

If the unit is used infrequently, difficult starting may result. To eliminate hard starting, follow these instructions:

1. Run the generator at least 30 minutes every month.
2. Run the generator, then close the fuel shut-off valve and allow the unit to run until the engine stops.
3. Move the engine switch to the "OFF" position.

Long Term Storage

It is important to prevent gum deposits from forming in essential fuel system parts such as the carburetor, fuel hoses or tank during storage. Also, experience indicates that alcohol-blended fuels (called gasohol, ethanol or methanol) can attract moisture, which leads to separation and formation of acids during storage. Acidic gas can damage the fuel system of an engine while in storage.

When the generator set is not being operated, or is being stored for more than one month, follow these instructions to avoid engine problems:

- 1-**ADD** a properly formulated commercially **FUEL STABILIZER** to the tank if it is not already added.
- 2-Operate the engine for 5-10 minutes to circulate treated fuel into fuel lines and carburetor before shutdown.
- 3- After engine cools down, remove all gasoline from the fuel tank. Use a commercially available, non-conductive vacuum siphon.

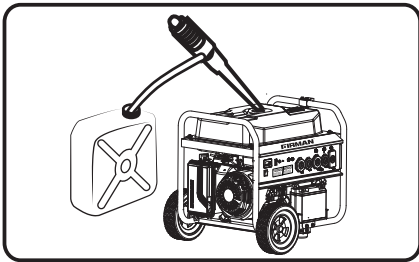

DANGER

Drain fuel into approved container outdoors, away from open flame. Be sure engine is cool. Do not smoke.

- 4-**FUEL STARVATION:** Start and run the generator until it stops from lack of fuel. This will dry out all remaining fuel in tank, fuel lines and carburetor.
- 5-Allow the unit to cool entirely before cleaning and storage.
- 6-Change oil with recommended grade oil.
- 7-Remove spark plug and pour about one teaspoon of engine oil through the spark plug hole, then pull the recoil starter several times to distribute the oil for lubricating the cylinder. Reattach the spark plug. Pull recoil slowly until resistance is felt. This will close the valves so moisture cannot enter engine cylinder. Gently release recoil starter.

8-Keep the engine switch and fuel valve on "OFF" position.

9-Cover the unit and store in a clean, dry place out of direct sunlight. **NEVER USE WATER TO CLEAN GENERATOR.**

NOTE:

- We recommend always using a fuel stabilizer. **A FUEL STABILIZER** will minimize the formulation of fuel gum deposits during storage, the fuel stabilizer can be added to the gasoline in the fuel tank, or into the gasoline in a storage container.
- If it is not practical to empty the fuel tank and the unit is to be stored for some time, use a commercially available **FUEL STABILIZER** added to the gasoline to increase the life of the gasoline. Run the unit for 5-10 minutes, turn off the fuel valve and allow to run until engine stops from lack of fuel (**FUEL STARVATION**).
- Any damages or hazards caused by using improper fuel, improperly stored fuel, and/or improperly formulated stabilizers, are not covered by manufacturer's warranty.
- Do not store gasoline from one season to another season.

TROUBLE SHOOTING

Problem	Cause	Correction
Engine is running, but no AC output is available.	<ol style="list-style-type: none"> 1. Circuit breaker is open. 2. Fault in generator. 3. Poor connection or defective cord set. 4. Connected device is bad. 	<ol style="list-style-type: none"> 1. Reset circuit breaker. 2. Contact authorized service facility. 3. Check and repair. 4. Connect another device that is in good condition.
Engine runs good at no-load but "bogs down" when loads are connected.	<ol style="list-style-type: none"> 1. Short circuit in a connected load. 2. Engine speed is too slow. 3. Generator is overloaded. 4. Shorted generator circuit. 5. Clogged or dirty fuel filter. 	<ol style="list-style-type: none"> 1. Disconnect shorted electrical load. 2. Contact authorized service facility. 3. See Don't Overload Generator 4. Contact authorized service facility. 5. Clean or replace fuel filter.
Engine will not start; starts and runs rough or shuts down when running.	<ol style="list-style-type: none"> 1. Engine switch set to OFF (O) position. 2. Fuel shutoff lever is in OFF (O) position. 3. Low oil level. 4. Dirty air cleaner. 5. Out of fuel. 6. Stale fuel. 7. Spark plug wire not connected to spark plug. 8. Bad spark plug. 9. Water in fuel. 10. Flooded. 11. Excessively rich fuel mixture. 12. Intake valve stuck open or closed. 13. Engine has lost compression. 14. Clogged or dirty fuel filter. 	<ol style="list-style-type: none"> 1. Set engine switch to ON (I) position. 2. Move fuel shutoff lever to ON (I) position. 3. Fill crankcase to proper level or place generator on level surface. 4. Clean or replace air cleaner. 5. Fill fuel tank. 6. Drain fuel tank and carburetor; fill with fresh fuel. 7. Connect wire to spark plug. 8. Replace spark plug. 9. Drain gas tank and carburetor; fill with fresh fuel. 10. Wait 5 minutes and re-crank engine. 11. Contact authorized service facility. 12. Contact authorized service facility. 13. Contact authorized service facility. 14. Clean or replace fuel filter.
Engine lacks power.	<ol style="list-style-type: none"> 1. Load is too high. 2. Dirty air filter. 3. Clogged or dirty fuel filter. 4. Clogged spark arrester. 	<ol style="list-style-type: none"> 1. Don't Overload Generator 2. Replace air filter. 3. Clean or replace fuel filter. 4. Clean or replace spark arrester.
Engine "hunts" or falters.	<ol style="list-style-type: none"> 1. Carburetor is running too rich or too lean. 2. Clogged or dirty fuel filter. 	<ol style="list-style-type: none"> 1. Contact authorized service facility. 2. Clean or replace fuel filter.
Engine shuts down when running.	<ol style="list-style-type: none"> 1. Out of fuel. 2. Dirty air cleaner. 3. Low oil level. 	<ol style="list-style-type: none"> 1. Fill fuel tank. 2. Clean or replace air cleaner. 3. Fill crankcase to proper level or place generator on level surface.

PARTS DIAGRAM AND PARTS LIST

P03609 Parts Diagram

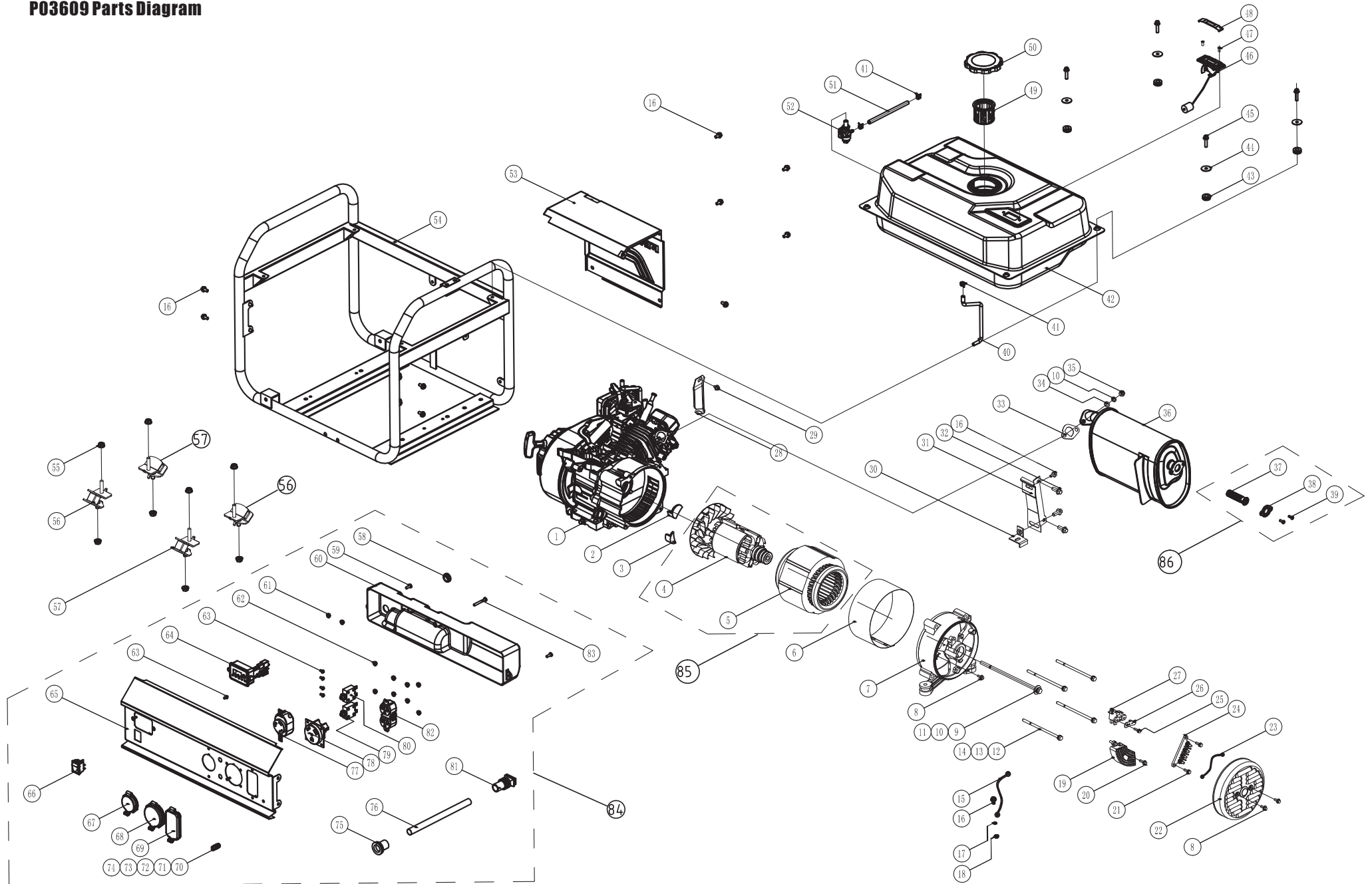

FIRMAN 208cc Engine Parts List

NO.	Part Number	Description	Qty.
1	336723500	Crankcase Subassembly.	1
2	336723501	Locating Pins	2
3	336723502	Sensor, Engine Oil	1
4	336723503	Flg. Bolt M6×12	8
5	336723504	Camshaft Assy.	1
6	336723505	Bearing	2
7	336723506	Gear, Crankshaft	1
8	336723507	Woodruff Key	1
9	336723508	Crankshaft	1
10	336723509	Gear, Drive	1
11	336723510	Gasket, Crankcase	1
12	336723511	Oil Dipstick Assy	1
13	336723512	Cover, Crankcase	1
14	336723513	Seal, Oil	2
15	336723514	Flg. Bolt M8×32	6
16	336723515	Rod, Connecting	1
17	336723516	Clip, Piston Pin	2
18	336723517	Pin, Piston	1
19	336723518	Piston	1
20	336723519	Ring Set, Oil	1
21	336723520	Ring, The Second	1
22	336723521	Ring, The First	1
23	336723522	Flg. Bolt M6×8	3
24	336723523	Air Guide Lower	1
25	336723524	Gasket, Cylinder Head Cover	1
26	336723525	Cover Subassembly, Cylinder Head	1
27	336723526	Flg. Bolt M6×15	7
28	336723527	Flg. Bolt M8×55	4
29	336723528	Nut, Valve Lock	2
30	336723529	Nut Valve Adjusting	2
31	336723530	Breather Tube	1
32	336723531	Rocker, Valve	2
33	336723532	Rotator, Valve	1
34	336723533	Retainer, Intake Valve	1
35	336723534	Retainer, Exhaust Valve	1
36	336723535	Spring, Valve	2
37	336723536	Oil Seal, Valve	2
38	336723537	Bolt, Valve Adjusting	2
39	336723538	Plate Subassembly, Lifter Stopper	1
40	336723539	Exhaust Valves Stud Bolt	2
41	336723540	Head Subassembly, Cylinder	1
42	336723541	Valve, Intake	1
43	336723542	Valve, Exhaust	1
44	336723543	Push Rod	2
45	336723544	Tappet, Valve	2
46	336723545	Washer, Drain Bolt	2
47	336723546	Bolt, Drain Plug	2
48	336723547	Locating Pins	2
49	336723548	Gasket, Cylinder Head	1
50	336723549	Stud, Intake	2
51	336723550	Gasket, Inlet	1
52	336723551	Plate, Carburetor Insulator	1
53	336723552	Gasket, Carburetor	1

NO.	Part Number	Description	Qty.
54	336723553	Carburetor	1
55	336723554	Gasket., Air Cleaner	1
56	336723555	Nut M6	3
57	336723556	Spark Plug	1
58	336723557	Elbow, Air Cleaner	1
59	336723558	Clapboard	1
60	336723559	Mounting Bolt, Air Cleaner	4
61	336723560	Element, Air Cleaner	1
62	336723561	Cover, Air Cleaner	1
63	336723562	Control Assembly	1
64	336723563	Shaft, Governor Arm	1
65	336723564	Rocker Shim	1
66	336723565	Pin, Shaft	1
67	336723566	Arm, Governor	1
68	336723567	Bolt, Governor Arm	1
69	336723568	Spring, Governor Arm	1
70	336723569	Rod, Governor	1
71	336723570	Spring, Throttle Return	1
72	336723571	Retainer, Diode	1
73	336723572	Wind Deflectors	1
74	336723573	Ignition Coil	1
75	336723574	Flg. Bolt M6×25	2
76	336723575	Protect Circle	1
77	336723616	Fan Cover Comp	1
78	336723577	Flg. Bolt M6×20	1
79	336723578	Air Guide, Right Side	1
80	336423505	Gasket Set	1
81	336723580	Locknut	1
82	336723581	Pulley,starter	1
83	336723582	Cooling Fan	1
84	336723583	Flywheel Comp	1
85	336723584	Grip,starter	1
86	336723585	Case Comp.,recoil Starter	1
87	336723586	Spring,starter Return	1
88	336723587	Cord	1
89	336723588	Pulley,recoil Starter	1
90	336723589	Spring,patchet	2
91	336723590	Patchet,starter	2
92	336723591	Pawl Guide	1
93	336723592	Clip Sprg.,pawl Guide	1
94	336723593	Screw,pawl Guide	1
95	336723594	Gov.,gear Shaft	1
96	336723595	Inner Washer,gear	1
97	336723596	Gear, Governor	1
98	336723597	Clip, Governor Gear	1
99	336723598	Bushing, Governor Gear	1
100	336713532	Auspuffdichtung	1
101	336423500	Recoil Starter Set	1
102	336423501	Governing Gear Set	1
103	336423502	Air Cleaner Set	1
104	336423503	Carburetor Set	1
105	336423504	Piston Rings Set	1

SERVICE INFORMATION

CONTACT THE FIRMAN PRODUCT SERVICE DEPARTMENT AT 1-844-347-6261

or at

www.firmanpowerequipment.com

**to obtain warranty service
information or to order
replacement parts or
accessories.**

HOW TO ORDER REPLACEMENT PARTS

Even quality built equipment such as the electric generator you have purchased might need occasional replacement parts to maintain it in good condition over the years. To order replacement parts, please give the following information:

1. Model No., Rev. Level and Serial No. and all specifications shown on the Model No./Serial No. plate.
2. Parts number or numbers as shown in the Parts List section.
3. A brief description of the trouble with the generator.

REGISTER YOUR PRODUCT

Register your Firman generator online at www.firmanpowerequipment.com

WARRANTY

FIRMAN Three (3) Year Limited Warranty

Warranty Qualifications

FIRMAN GENERATOR will register the warranty upon receipt of your Warranty Registration Card and a copy of your sales receipt from one of FIRMAN's retail locations as proof of purchase. Please submit your warranty registration and your proof of purchase within ten (10) days of the date of purchase.

Repair/Replacement Warranty

FIRMAN warrants to the original purchaser that the mechanical and electrical components will be free of defects in material and workmanship for a period of one (1) year (parts and labor) and three (3) years (parts) from the original date of purchase 90 days [parts and labor] and 180 days [parts] for commercial & industrial use. Transportation charges on product submitted for repair or replacement under this warranty are the sole responsibility of the purchaser. This warranty only applies to the original purchaser and is not transferable.

Do Not Return the Unit to the Place of Purchase

Contact the FIRMAN Service Center and FIRMAN will troubleshoot any issue via phone or e-mail. If the problem is not corrected by this method, FIRMAN will, at its option, authorize evaluation, repair or replacement of the defective part or component at a FIRMAN Service Center. FIRMAN will provide you with a case number for warranty service. Please keep it for future reference. Repairs or replacements without prior authorization, or at an unauthorized repair facility, will not be covered by this warranty.

Warranty Exclusions

This warranty does not cover the following repairs and equipment:

Normal Wear

Your product needs periodic parts and service to perform well. This warranty does not cover repair when normal use has exhausted the life of a part or the equipment as a whole.

Installation, Use and Maintenance

This warranty will not apply to parts and/or labor if your product is deemed to have been misused, neglected, involved in an accident, abused, loaded beyond the generator's limits, modified, installed improperly or connected incorrectly to any electrical component.

Normal maintenance is not covered by this warranty.

Other Exclusions

This warranty excludes:

- cosmetic defects such as paint, decals, etc.
- wear items
- accessory parts
- failures due to acts of God and other force majeure events beyond the manufacturer's control
- problems caused by parts that are not original FIRMAN parts
- units used for prime power in place of existing utility power where utility is present or in place of utility power where utility power service does not normally exist.

Limits of Implied Warranty and Consequential Damage

FIRMAN disclaims any obligation to cover any loss of time, use of this product, freight, or any incidental or consequential claim by anyone from using this product. THIS WARRANTY IS IN LIEU OF ALL OTHER WARRANTIES, EXPRESS OR IMPLIED, INCLUDING WARRANTIES OF MERCHANTABILITY OR FITNESS FOR A PARTICULAR PURPOSE.

A unit provided as an exchange will be subject to the warranty of the original unit. The length of the warranty governing the exchanged unit will remain calculated by reference to the purchase date of the original unit.

This warranty gives you certain legal rights which may change from state to state. Your state may also have other rights you may be entitled to that are not listed within this warranty.

Contact Information

You may contact FIRMAN at:

Address

Firman Power Equipment Inc.
Attn: Customer Service
8716 West Ludlow Dr. Suite #6
Peoria, AZ 85381
www.firmanpowerequipment.com

*We are FIRMAN POWER - And we are here for you.
Customer Service Desk - 1-844-347-6261(1-844-FIRMAN1)
6am PST(9am EST) until 8pm EST(5pm PST)
Technical Service Desk - 1-844-347-6261(1-844-FIRMAN1)
6am PST(9am EST) until 8pm EST(5pm PST)
24/7 Tech Support - 1-844-347-6261(1-844-FIRMAN1)*

FIRMAN POWER EQUIPMENT INC. Emission Control System Warranty

CALIFORNIA AND FEDERAL EXHAUST AND EVAPORATIVE EMISSIONS CONTROL WARRANTY STATEMENT

YOUR WARRANTY RIGHTS AND OBLIGATIONS

The California Air Resources Board, US Environmental Protection Agency ("US EPA") and FIRMAN POWER EQUIPMENT INC.(FIRMAN) are pleased to explain the emissions control systems warranty on your 2019-2020 or later Small Off-Road Engine ("SORE") and engine powered equipment. In California, new equipment that use small off-road engines must be designed, built and equipped to meet the State's stringent anti-smog standards. FIRMAN must warrant the emissions control systems on your SORE and engine powered equipment for the periods of time listed below provided there has been no abuse, neglect or improper maintenance of your small off-road engine or equipment leading to the failure of the emissions control system. Your emissions control system may include parts such as the carburetor or fuel-injection system, the ignition system, catalytic converter, fuel tanks, fuel lines (for liquid fuel and fuel vapors), fuel caps, valves, canisters, filters, clamps and other associated components. Also included may be hoses, belts, connectors, and other emission-related assemblies.

Where a warrantable condition exists, FIRMAN will repair your SORE and engine powered equipment at no cost to you including diagnosis, parts and labor.

MANUFACTURER'S WARRANTY COVERAGE:

The exhaust and evaporative emissions control system on your small off-road engine and engine powered equipment is warranted for two years. If any emissions-related part on your small off-road engine and engine powered equipment is defective, the part will be repaired or replaced by FIRMAN.

OWNER'S WARRANTY RESPONSIBILITIES:

As the SORE and engine powered equipment owner, you are responsible for the performance of the required maintenance listed in your owner's manual. FIRMAN recommends that you retain all receipts covering maintenance on your SORE and engine powered equipment, but FIRMAN cannot deny warranty coverage solely for the lack of receipts or for your failure to ensure the performance of all scheduled maintenance.

As the SORE and engine powered equipment owner, you should however be aware that FIRMAN may deny you warranty coverage if your small off-road engine or engine powered equipment or a part has failed due to abuse, neglect, or improper maintenance or unapproved modifications.

You are responsible for presenting your small off-road engine and engine powered equipment to a FIRMAN distribution center or service center as soon as the problem exists. The warranty repairs shall be completed in a reasonable amount of time, not to exceed 30 days.

If you have any questions regarding your warranty rights and responsibilities, you should contact FIRMAN at 1-844-347-6261 or support@firmanpowerequipment.com.

FIRMAN Emission Control Defects Warranty Provisions

The warranty period begins on the date the engine/equipment is delivered to an ultimate purchaser. FIRMAN warrants to the ultimate purchaser and each subsequent purchaser that the engine is:

Designed, built, and equipped so as to conform with all applicable regulations adopted by the Air Resources Board and US EPA; and Free from defects in materials and workmanship that cause the failure of a warranted part to be identical in all material respects to the part as described in the engine manufacturers application for certification.

The warranty on emissions-related parts is as follows:

- (1) Any warranted part that is not scheduled for replacement as required maintenance in the owner's manual supplied, is warranted for the warranty period stated above. If any such part fails during the period of warranty coverage, the part will be repaired or replaced by FIRMAN at no charge to the owner. Any such part repaired or replaced under the warranty will be warranted for the remaining warranty period.
- (2) Any warranted part that is scheduled only for regular inspection in the owner's manual supplied, is warranted for the warranty period stated above. Any such part repaired or replaced under warranty will be warranted for the remaining warranty period.
- (3) Any warranted part that is scheduled for replacement as required maintenance in the owner's manual supplied, is warranted for the period of time prior to the first scheduled replacement point for that part. If the part fails prior to the first scheduled replacement, the part will be repaired or replaced by FIRMAN at no charge to the owner. Any such part repaired or replaced under warranty will be warranted for the remainder of the period prior to the first scheduled replacement point for the part.
- (4) Repair or replacement of any warranted part under the warranty must be performed at no charge to the owner at a warranty station.
- (5) Notwithstanding the provisions of Subsection (4) above, warranty services or repairs must be provided by FIRMAN that are franchised to service the subject engines.
- (6) The owner must not be charged for diagnostic labor that leads to the determination that a warranted part is in fact defective, provided that such diagnostic work is performed at a warranty station.
- (7) FIRMAN is liable for damages to other engine components proximately caused by a failure under warranty of any warranted part.

- (8) Throughout the emissions warranty period defined in Subsection (b)(2), FIRMAN will maintain a supply of warranted parts sufficient to meet the expected demand for such parts.
- (9) Any replacement part may be used in the performance of any warranty maintenance or repairs and must be provided without charge to the owner. Such use will not reduce the warranty obligations of the manufacturer.
- (10) Add-on or modified parts that are not exempted by the Air Resources Board may not be used. The use of any non-exempted add-on or modified parts by the ultimate purchaser will be grounds for disallowing a warranty claim.
- The manufacturer will not be liable to warrant failures of warranted parts caused by the use of a non-exempted add-on or modified part.

PARTS COVERED BY WARRANTY

Listed below are the parts (if equipped) covered by the Federal and California Emission Control System Warranty.

<p>1. Ignition system including:</p> <ul style="list-style-type: none"> - Spark plug - Ignition coil <p>2. Fuel metering system:</p> <ul style="list-style-type: none"> - Fuel tank - Fuel cap - Fuel lines (for liquid fuel and fuel vapors) and related fittings/clamps - Fuel regulator, carburetor and internal parts. <p>3. Catalytic muffler assembly including:</p> <ul style="list-style-type: none"> - Exhaust manifold - Catalytic converter - Muffler gasket -pulse valve 	<p>4. Air induction system including:</p> <ul style="list-style-type: none"> - Intake pipe/manifold - Air cleaner <p>5. Crankcase breather assembly including:</p> <ul style="list-style-type: none"> - Breather connection tube <p>6. Fuel tank evaporative emission control system including:</p> <ul style="list-style-type: none"> - Purge valves - Carbon canister - Vapor hoses and fitting/clamps
--	--

Limitations

This Emission Control System Warranty shall not cover any of the following:

- (a) Consequential damages such as loss of time, inconvenience, loss of use of the engine or equipment, etc.
- (b) Diagnosis and inspection fees that do not result in eligible warranty service being performed.

FIRMAN POWER EQUIPMENT INC.
 Email: support@firmanpowerequipment.com
 www.firmanpowerequipment.com

Firman Power Equipment Inc.
8716 West Ludlow Dr. Suite #6
Peoria, AZ 85381
www.firmanpowerequipment.com