



**DGE2000 Series Dual-Channel
Arbitrary Waveform Generator
User Manual**

For product support, visit: www.owon.com.hk/download

Nov 2022 Edition V1.0.0

Copyright © LILLIPUT Company. All rights reserved.

The LILLIPUT's products are under the protection of the patent rights, including ones which have already obtained the patent rights and those which are applied for. The information in this manual will replace all materials published.

The information in this manual was correct at the time of printing. However, LILLIPUT will continue to improve products and reserves the rights to change specification at any time without notice.

owon[®] is the registered trademark of the LILLIPUT Company.

Fujian LILLIPUT Optoelectronics Technology Co., Ltd.

No. 19, Heming Road

Lantian Industrial Zone, Zhangzhou 363005 P.R. China

Tel: +86-596-2130430

Fax: +86-596-2109272

Web: www.owon.com

E-mail: info@owon.com.cn

General Warranty

We warrant that the product will be free from defects in materials and workmanship for a period of 3 years from the date of purchase of the product by the original purchaser from our company. The warranty period for accessories such as probes, battery is 12 months. This warranty only applies to the original purchaser and is not transferable to a third party.

If the product proves defective during the warranty period, we will either repair the defective product without charge for parts and labour, or will provide a replacement in exchange for the defective product. Parts, modules and replacement products used by our company for warranty work may be new or reconditioned like new. All replaced parts, modules and products become the property of our company.

In order to obtain service under this warranty, the customer must notify our company of the defect before the expiration of the warranty period. Customer shall be responsible for packaging and shipping the defective product to the designated service centre, a copy of the customers proof of purchase is also required.

This warranty shall not apply to any defect, failure or damage caused by improper use or improper or inadequate maintenance and care. We shall not be obligated to furnish service under this warranty a) to repair damage resulting from attempts by personnel other than our company representatives to install, repair or service the product; b) to repair damage resulting from improper use or connection to incompatible equipment; c) to repair any damage or malfunction caused by the use of not our supplies; or d) to service a product that has been modified or integrated with other products when the effect of such modification or integration increases the time or difficulty of servicing the product.

Please contact the nearest Sales and Service Offices for services.

Excepting the after-sales services provided in this summary or the applicable warranty statements, we will not offer any guarantee for maintenance definitely declared or hinted, including but not limited to the implied guarantee for marketability and special-purpose acceptability. We should not take any responsibilities for any indirect, special or consequent damages.

Table of Contents

1.General Safety Requirement	1
2.Safety Terms and Symbols	2
3.General Inspection	3
4.Quick Start	4
Front Panel Overview	4
Rear Panel Overview	5
Power On.....	6
User Interface.....	6
5.Panel Operation	7
Channel Setting.....	7
Select the channel for configuration	7
To Display/Edit Both Channels	7
Turn on/off channel output.....	8
Waveform Setting.....	8
Output Sine Wave	8
Set the frequency/period.....	9
Set the amplitude	9
Set the offset	9
Set the high level.....	10
Set the low level	10
Set the Phase	10
Output Square Wave	10
Output Ramp Wave	11
Set the symmetry	12
Output Pulse Wave	12
Set the pulse width/duty cycle	13
Set the rising/falling time.....	16
Output Noise Wave	16
Output Arbitrary Wave	16
Select build-in wave (including DC)	17
File Sore Syetem.....	22
Generate Sweep (Sweep).....	24
Generate Burst (Burst)	25
Output the Modulated Waves	27
AM (Amplitude Modulation)	27
FM (Frequency Modulation)	29
PM (Phase Modulation).....	30

FSK (Frequency Shift Keying)	31
Utility Function Setting	32
Display Settings.....	32
Brightness Control	32
Screen Saver	32
Separator.....	33
CH1/2 Settings.....	33
System Settings.....	34
Language.....	34
Beeper.....	34
USB Device Type	34
Restore to the factory setting	34
Firmware Update.....	36
6.Troubleshooting.....	37
7.Specification.....	38
Waveforms.....	38
Frequency Characteristics	38
Amplitude Characteristics	39
Signal Characteristics.....	39
Modulation Characteristics	40
Sweep Characteristics.....	41
Burst Characteristics.....	42
Input/Output Characteristics.....	42
General Specifications	42
8.Appendix	43
Appendix A: Accessories	43
Appendix B: General Care and Cleaning.....	43

1. General Safety Requirement

Before any operations, please read the following safety precautions to avoid any possible bodily injury and prevent this product or any other products connected from damage. In order to avoid any contingent danger, this product is only used within the range specified.

Only the qualified technicians can implement the maintenance.

To avoid Fire or Personal Injury:

Use Proper Power Cord. Use only the power cord supplied with the product and certified to use in your country.

Product Grounded. This instrument is grounded through the power cord grounding conductor. To avoid electric shock, the grounding conductor must be grounded. The product must be grounded properly before any connection with its input or output terminal.

Limit operation to the specified measurement category, voltage, or amperage ratings.

Check all Terminal Ratings. To avoid fire or shock hazard, check all ratings and markers on the instrument. Refer to the user's manual for more information about ratings before connecting the instrument. Do not exceed any of ratings defined in the following section.

Do not operate without covers. Do not operate the instrument with covers or panels removed.

Use Proper Fuse. Use only the specified type and rating fuse for this instrument.

Avoid exposed circuit. Do not touch exposed junctions and components when the instrument is powered.

Do not operate if in any doubt. If you suspect damage occurs to the instrument, have it inspected by qualified service personnel before further operations.

Use your instrument in a well-ventilated area. Inadequate ventilation may cause an increasing of temperature or damages to the instrument. Please keep the instrument well ventilated, and inspect the air outlet and the fan regularly.

Do not operate in wet conditions. To avoid short circuit inside the instrument or electric shock, never operate the instrument in a humid environment.

Do not operate in an explosive atmosphere.

Keep instrument surfaces clean and dry.

2. Safety Terms and Symbols

Safety Terms

Terms in this Manual. The following terms may appear in this manual:



Warning: Warning indicates the conditions or practices that could result in injury or loss of life.



Caution: Caution indicates the conditions or practices that could result in damage to this product or other property.

Terms on the Product. The following terms may appear on this product:

Danger: It indicates an injury or hazard may immediately happen.

Warning: It indicates an injury or hazard may be accessible potentially.

Caution: It indicates a potential damage to the instrument or other property might occur.

Safety Symbols

Symbols on the Product. The following symbol may appear on the product:



Hazardous Voltage



Refer to Manual



Protective Earth Terminal



Chassis Ground



Test Ground

3. General Inspection

After you get a new generator, it is recommended that you should make a check on the instrument according to the following steps:

1. Check whether there is any damage caused by transportation.

If it is found that the packaging carton or the foamed plastic protection cushion has suffered serious damage, do not throw it away first till the complete device and its accessories succeed in the electrical and mechanical property tests.

2. Check the Accessories

The supplied accessories have been already described in *Appendix A: Accessories* of this manual. You can check whether there is any loss of accessories with reference to this description. If it is found that there is any accessory lost or damaged, please get in touch with our distributor responsible for this service or our local offices.

3. Check the Complete Instrument

If it is found that there is damage to the appearance of the instrument, or the instrument can not work normally, or fails in the performance test, please get in touch with our distributor responsible for this business or our local offices. If there is damage to the instrument caused by the transportation, please keep the package. With the transportation department or our distributor responsible for this business informed about it, a repairing or replacement of the instrument will be arranged by us.

4. Quick Start

Front Panel Overview

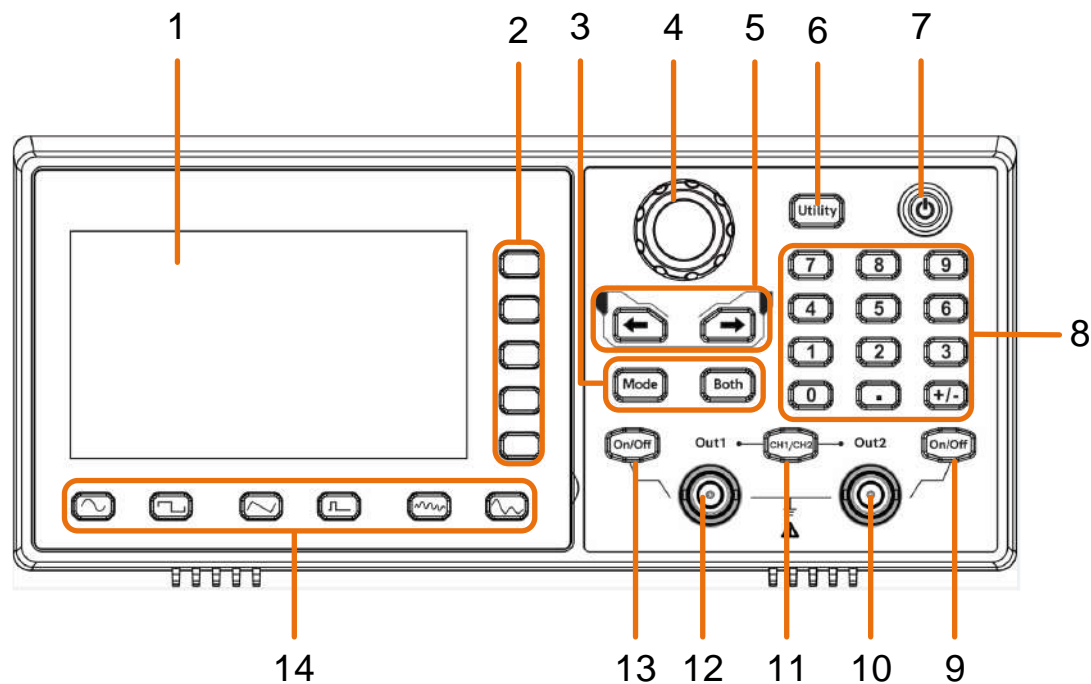







Figure 4-1: Front Panel Overview

1	LCD	Display the user interface
2	Menu selection keys	Includes 5 keys to activate the corresponding menu
3	Operation keys	Mode: output the modulated waveform Both: Display the editable parameters of both channels.
4	Knob	Change the currently selected value, also used to select the arbitrary waveform types and arb data file name. When in the sweep manual mode, press this knob to trigger manually
5	Direction key	Move the cursor of the selected parameter
6	Utility	set the utility function
7	Power button	Turn on/off the waveform generator.
8	Number keypad	Input the parameter

9	On/Off button	Turns the output of the CH2 channel on or off. When the output is turned on, the backlight of the button lights up
10	Out 2	Output CH2 signal
11	CH1/CH2	Switch channel displayed on the screen between CH1 and CH2
12	Out 1	Output CH1 signal
13	On/Off button	Turns the output of the CH1 channel on or off. When the output is turned on, the backlight of the button lights up
14	Waveform Selection area	Includes: Sine  , Square  , Ramp  , Pulse  , Noise  , Arb Wave 

Rear Panel Overview

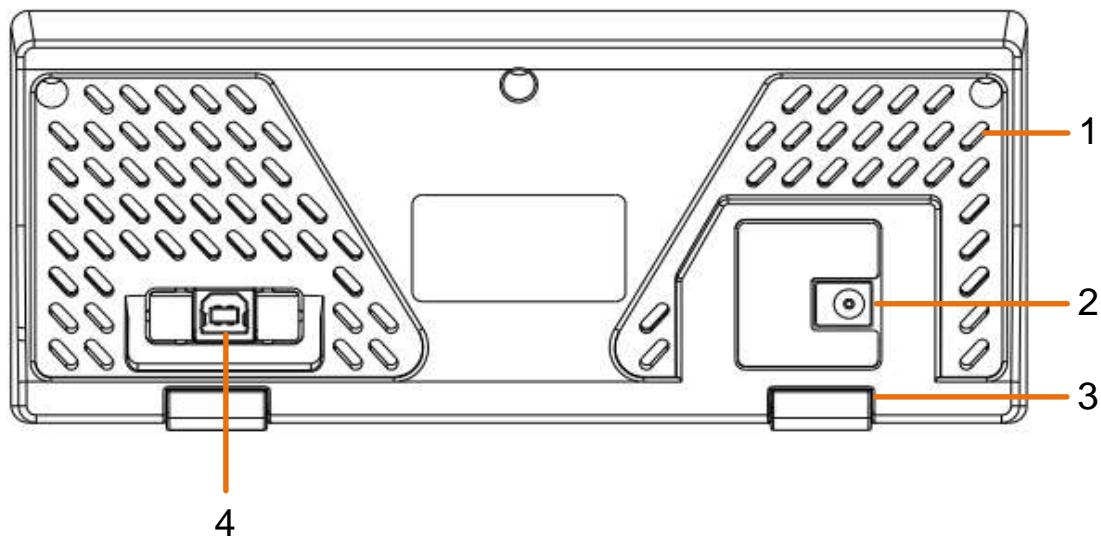

Figure 4-2: Rear Panel Overview

1	Air vents	
2	Power input connector	DC power input connector
3	Foot Stool	Tilt the signal generator for easy operation.
4	USB Device interface	Used to connect a USB type B controller. Can be connected with PC, the signal generator can be controlled by the host computer software.

Power On

- (1) Connect the instrument to the AC power using the DC power adapter provided in the attachment.



Warning:

To prevent electric shock, make sure the instrument is properly grounded.

- (2) Press the **power button** on the front panel. The back of the power channel switch will light up, and the buzzer will sound.

User Interface

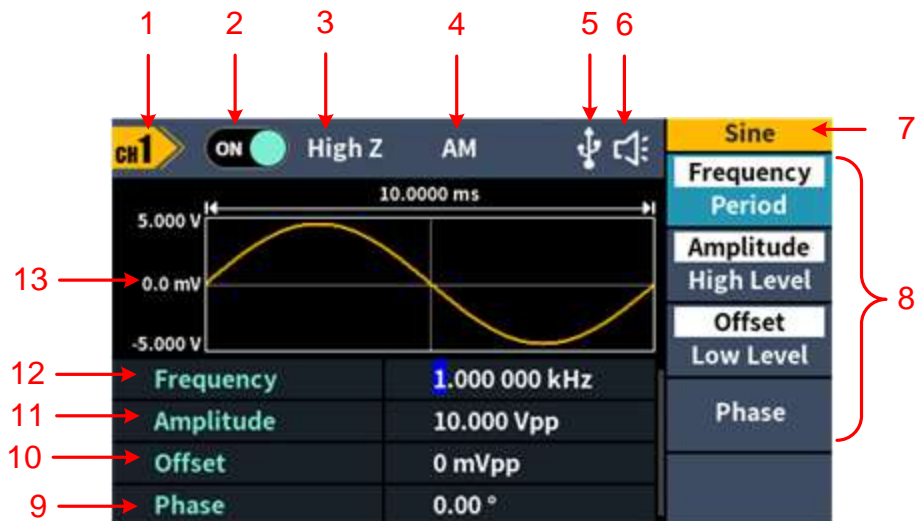

Figure 4-3: User Interface

1	Display channel name
2	Display channel switch status
3	Display load
4	Current waveform mode
5	Lights up the indicator when connected to the USB Host via the USB DEVICE interface
6	Buzzer
7	Menu title
8	Current waveform or mode setting menu
9	Start phase

10	Offset / low level, depending on the right highlighted menu item
11	Amplitude / high level, depending on the right highlighted menu item
12	Frequency/Period, depending on the highlighted menu item on the right
13	Display current waveform

5. Panel Operation

Channel Setting

Select the channel for configuration

Before configuring waveform parameters, you must first select the channel you want to configure. Press **CH1 /CH2** to switch to the desired channel, and the user interface displays channel information.

To Display/Edit Both Channels

Press **Both** button to display the parameters of both channels.

To switch channel: Press **CH1/2** to switch the editable channel.

To select waveform: Press **Waveform selection buttons** to select waveform of current channel.

To select parameter: Press **Menu selection keys** to choose the **Parameter 1** to **Parameter 4** (**Corresponding keys 2-4**) ; Press it again to switch the current parameter such as Frequency/Period.

To edit parameter: Turn the **knob** to change the value of cursor position. Press **←/→** direction key to move the cursor. (The number keys can not be used to input.)

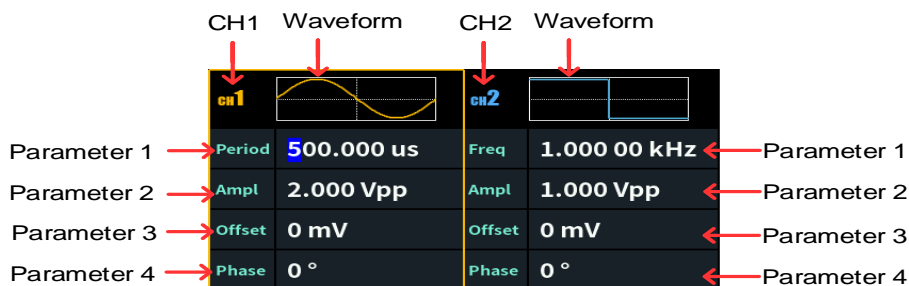







Figure 5-1: The User Interface of **Both** button

Turn on/off channel output

Press CH1 **On/Off** or CH2 **On/Off** on the front panel to turn on/off the corresponding channel output. The backlight of the button will light up when it is set to output.

Waveform Setting

Sine, square, ramp, pulse, noise or arbitrary waves can be set and output. Press the waveform selection button on the front panel: sine , square , ramp , pulse , noise , arbitrary wave , and enter the corresponding waveform setting interface. The waveform is different and the parameters that can be set are different.

Note: The following setting waveform uses CH1 channel as an example. If you need to set CH2 channel, please refer to CH1 channel specific operation.

Output Sine Wave

Press , the screen displays the user interface of the sine wave. The Sine waveform parameters can be set by operating the Sine setting menu on the right.

The sine wave menu includes: **Frequency/Period**, **Amplitude/High Level**, **Offset/Low Level** and **Phase**. The menu can be operated by the menu selection button on the right.

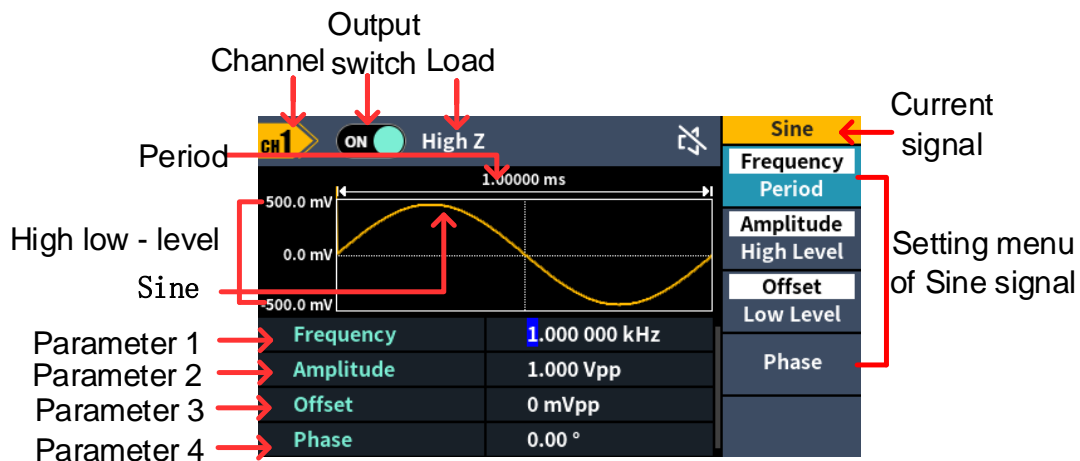

Figure 5-2: Sine wave user interface

Set the frequency/period

- Press **CH1/CH2**, Select Display **CH1** channel.
- Press the On/Off button on the CH1, enable channel CH1.
- Press the **Frequency/Period** softkey, the selected menu item is highlighted in white, and a cursor will display on the corresponding parameter item in **Parameter 1**. Press the **Frequency/Period** softkey to switch the frequency and period.

There are two ways to change the selected parameter value:

- Turn the **knob** to increase or decrease the value at the cursor. Press the **←/→** arrow key to move the cursor left or right.
- Press a number key on the **numeric keypad** directly, the screen will pop out the data input box, input the desired value. Press the **MHz**, **kHz**, **Hz**, **mHz**, **uHz** softkeys to select the unit of the parameter, confirm numeric input. Press the **Back** softkey to cancel the current input parameter value.



Figure 5-3: Use the numeric keypad to set the frequency

Set the amplitude

Press the **Amplitude/High Level** softkey to confirm whether the **Amplitude** menu item is highlighted; if not, press the **Amplitude/High Level** softkey to switch to **Amplitude**. In **Parameter 2** of Figure 5-2, a blinking cursor appears in the parameter value of amplitude. Turn the **knob** to change the value directly, or use the **numeric keypad** to input the desired value and choose the unit.

Set the offset

Press the **Offset/Low Level** softkey to confirm whether the **Offset** menu item is highlighted; if not, press the **Offset/Low Level** softkey to switch to **Offset**. In **Parameter 3** of Figure 5-2, a blinking cursor appears in the parameter value of

offset. Turn the **knob** to change the value directly, or use the **numeric keypad** to input the desired value and choose the unit.

Set the high level

Press the **Amplitude/High Level** softkey to confirm whether the **High Level** menu item is highlighted; if not, press the **Amplitude/High Level** softkey to switch to **High Level**. In **Parameter 2** of Figure 5-2, a blinking cursor appears in the parameter value of high level. Turn the **knob** to change the value directly, or use the **numeric keypad** to input the desired value and choose the unit.

Set the low level

Press the **Offset/Low Level** softkey to confirm whether the **Low Level** menu item is highlighted; if not, press the **Offset/Low Level** softkey to switch to **Low Level**. In **Parameter 3** of Figure 5-2, a blinking cursor appears in the parameter value of low level. Turn the **knob** to change the value directly, or use the **numeric keypad** to input the desired value and choose the unit.

Set the Phase

Press the **Phase** softkey, the **Phase** menu item is highlighted. In **Parameter 4** of Figure 5-2, a blinking cursor appears in the parameter value of Phase. Turn the **knob** to change the value directly, or use the **numeric keypad** to input the desired value and choose the unit.

Output Square Wave

Press , the screen displays the user interface of the square wave. The Square waveform parameters can be set by operating the Square setting menu on the right.

The square wave menu includes: **Frequency/Period**, **Amplitude/High Level**, **Offset/Low Level**, and **Phase**.

To set the Frequency/Period, Amplitude/High Level, Offset/Low Level, Phase, please refer to *Output Sine Wave* on page 8.

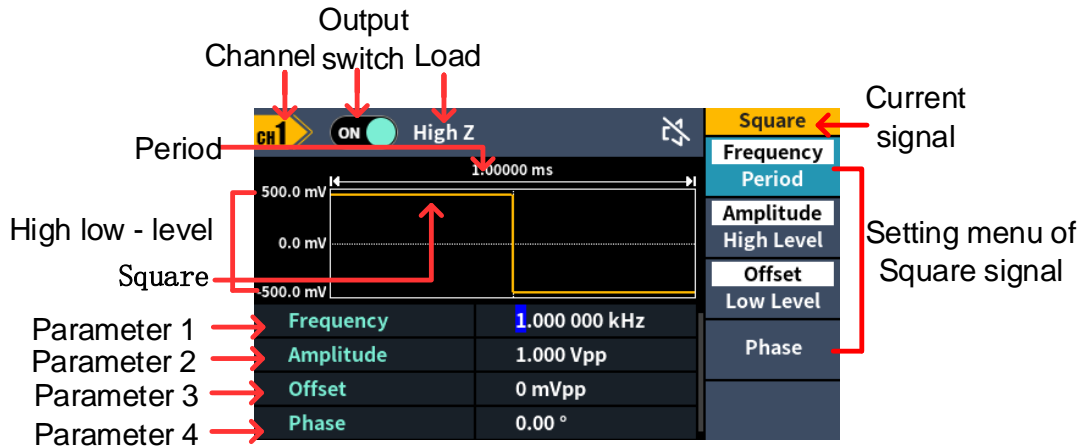



Figure 5-4: Square wave user interface

Output Ramp Wave

Press , the screen displays the user interface of the ramp wave. The Ramp waveform parameters can be set by operating the Ramp setting menu on the right.

The ramp menu includes: **Frequency/Period**, **Amplitude/High Level**, **Offset/Low Level**, **Phase**, and **Symmetry**.

To set the Frequency/Period, Amplitude/High Level, Offset/Low Level, Phase, please refer to *Output Sine Wave* on page 8.

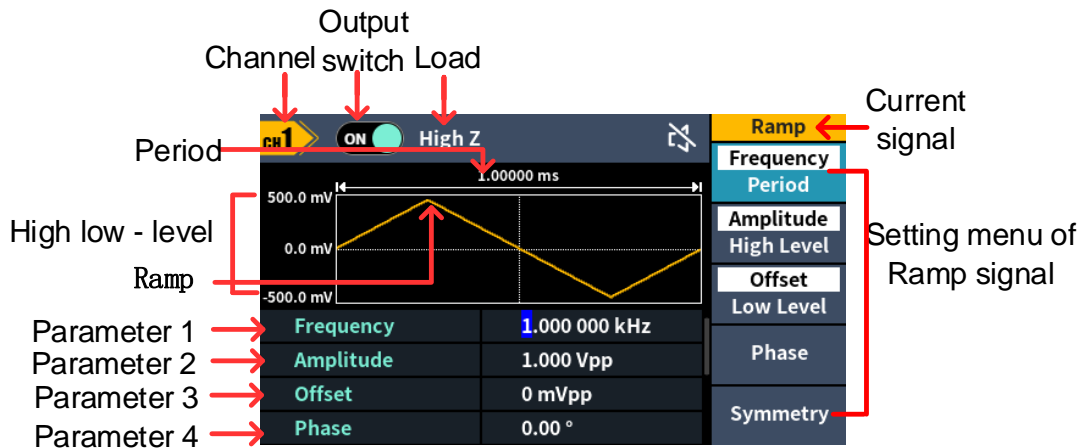

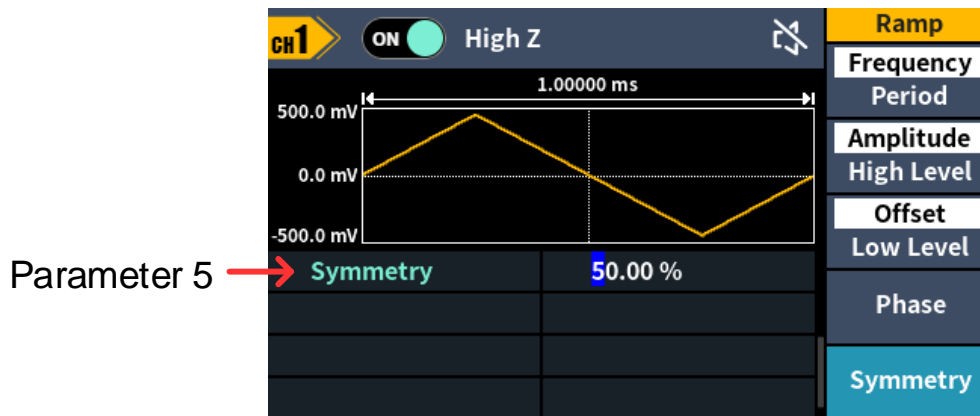

Figure 5-5: Ramp wave user interface

Set the symmetry

Press the **Symmetry** softkey, the **Symmetry** menu item is highlighted. In **Parameter 5** of Figure 5-5, a blinking cursor appears in the parameter value of symmetry. Turn the **knob** to change the value directly, or use the **numeric keypad** to input the desired value and choose the unit.

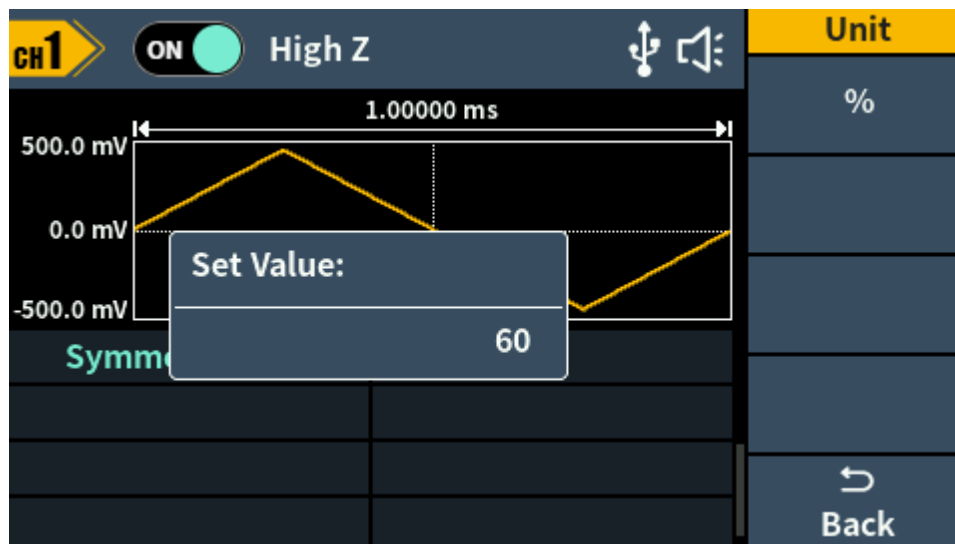



Figure 5-6: Set the symmetry of ramp wave

Glossary

Symmetry: Sets the percentage of the period during which the ramp waveform is rising.

Output Pulse Wave

Press , the screen displays the user interface of the pulse wave. The Pulse waveform parameters can be set by operating the Pulse setting menu on the right.

The pulse wave menu includes: **Frequency/Period**, **Amplitude/High Level**,

Offset/Low Level, Phase, Pulse Width/Duty Cycle, and RiseTime/FallTime.
 To set the Frequency/Period, Amplitude/High Level, Offset/Low Level, Phase, please refer to *Output Sine Wave* on page 8.

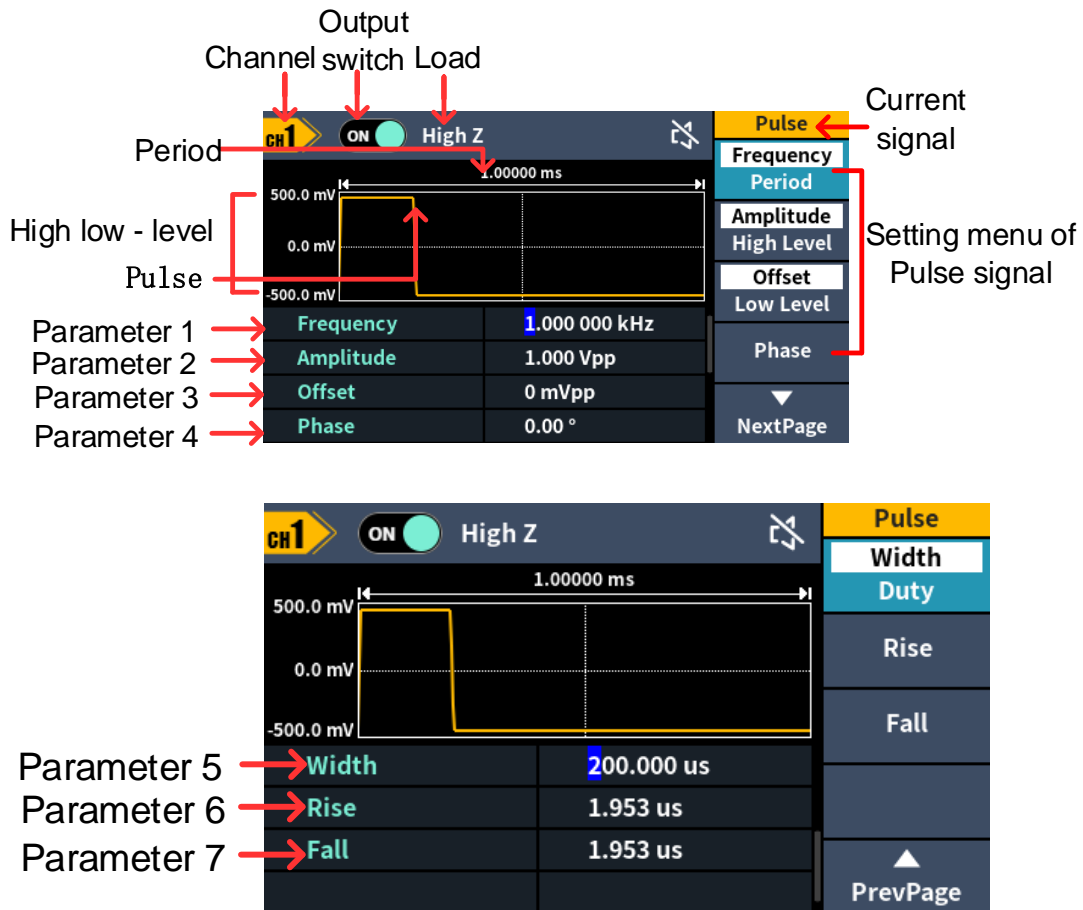

Figure 5-7: Pulse wave user interface

Set the pulse width/duty cycle

Press the **Width/DutyCyc** softkey, the chosen menu item is highlighted. Press the **Width/DutyCyc** softkey to switch between Pulse Width and Duty Cycle. In **Parameter 5** of Figure 5-7, a blinking cursor appears in the parameter value. Turn the **knob** to change the value directly, or use the **numeric keypad** to input the desired value and choose the unit.

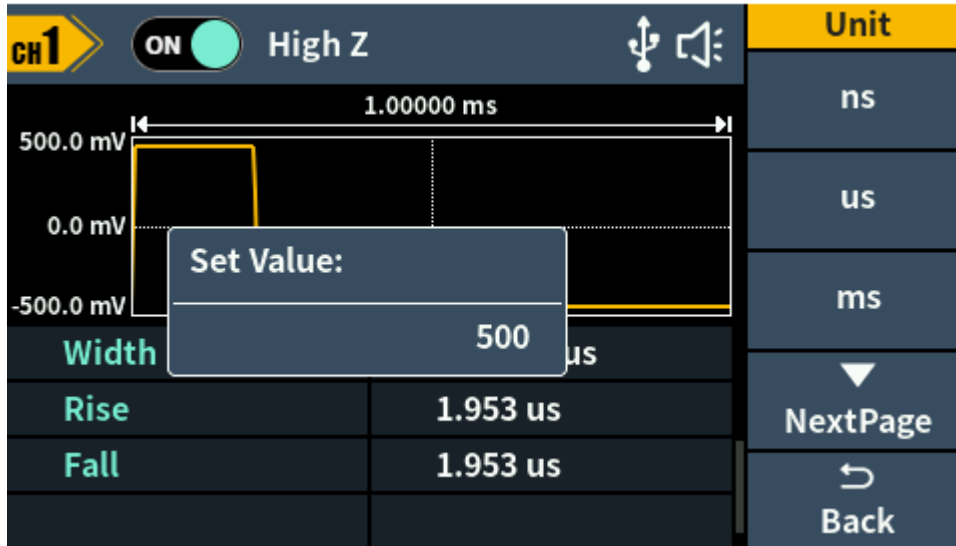

Figure 5-8: Set the pulse width

Glossary

Pulse Width

PW is an abbreviation for pulse width and is divided into positive pulse width and negative pulse width.

The positive pulse width is the time interval from 50% of the rising edge to 50% of the adjacent falling edge.

The negative pulse width is the time interval from 50% of the falling edge to 50% of the adjacent rising edge.

The pulse width is determined by the period and duty cycle of the signal. The calculation formula is pulse width = period * duty cycle.

Duty Cycle

In a series of ideal pulse sequences (such as a square wave), the ratio of the duration of the positive pulse to the total pulse period.

Pulse/Duty Cycle

The pulse width is defined as the time interval from the 50% threshold of the amplitude of the rising edge of the pulse to the 50% threshold of the amplitude of the next falling edge, as shown in the following figure.

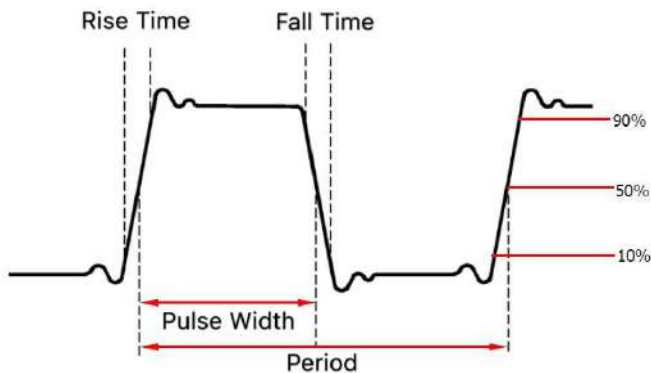

- The settable range of pulse width is limited by the "minimum pulse width" and "pulse period"
 $\text{Pulse width} \geq \text{minimum pulse width}$
 $\text{Pulse width} \leq \text{pulse period} - \text{minimum pulse width}$
- The pulse duty cycle is defined as the pulse width as a percentage of the pulse period.
- The pulse duty cycle is associated with the pulse width, and modifying one of the parameters will automatically modify the other parameter. The pulse duty cycle is limited by the "minimum pulse width" and "pulse period".
 $\text{Pulse duty cycle} \geq \text{minimum pulse width} \div \text{pulse period} \times 100\%$
 $\text{Pulse duty cycle} \leq (1 - 2 \times \text{minimum pulse width} \div \text{pulse period}) \times 100\%$

Set the rising/falling time

Press the **Rise/Fall** softkey, the chosen menu item is highlighted. Press the **Rise/Fall** softkey to switch between Rising Time and Falling Time. In **Parameter 6** of Figure 5-7, a blinking cursor appears in the parameter value. Turn the **knob** to change the value directly, or use the **numeric keypad** to input the desired value and choose the unit.

Output Noise Wave

The noise wave which the generator output is white noise. Press , the screen displays the user interface of the noise wave. The Noise waveform parameters can be set by operating the Noise setting menu on the right.

The noise wave has no frequency and periodic parameters.

The noise wave menu includes: **Amplitude/High Level, Offset/Low Level**.

To set the Amplitude/High Level, Offset/Low Level, please refer to *Output Sine Wave* on page 8.

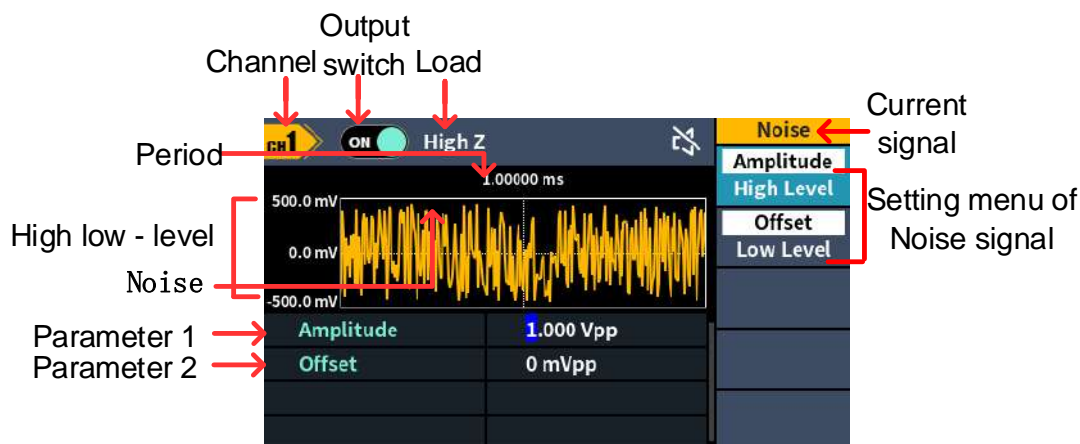



Figure 5-9: Noise wave user interface

Output Arbitrary Wave

Press , the screen displays the user interface of the arbitrary wave. The Arbitrary waveform parameters can be set by operating the Arbitrary setting menu on the right.

The arbitrary wave menu includes: **Frequency/Period, Amplitude/High Level, Offset/Low Level, Phase, Built-in Waveform** and **Store**.

To set the Frequency/Period, Amplitude/High Level, Offset/Low Level, Phase, please refer to *Output Sine Wave* on page 8.

The Arbitrary signal consists of two types: the system built-in waveform and the user-definable waveform.

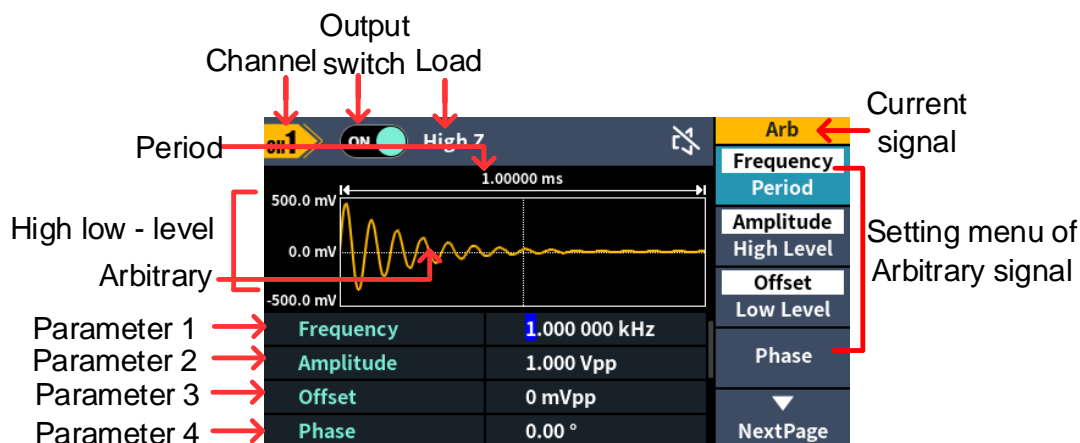

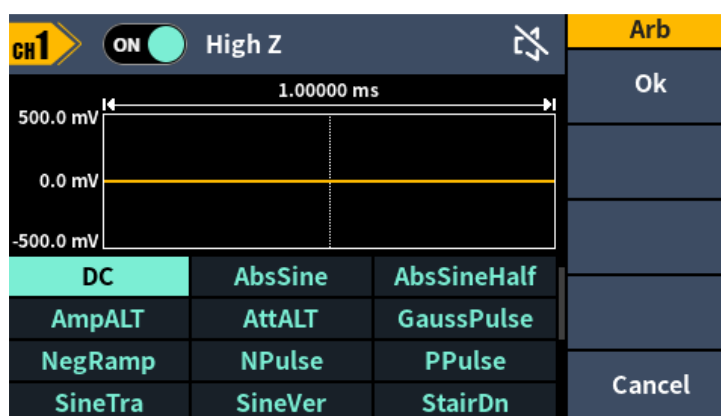

Figure 5-10: Arbitrary wave user interface

Select build-in wave (including DC)

There are 152 types of waveforms built in the generator, the number of waveform points is 8192 points, and the highest upper limit frequency is 15MHz. To select a built-in waveform, the steps are as follows:

- (1) Press the  **Arb** wave button, then press the **NextPage** button to enter the nextpage menu.
- (2) Press the **Built-in** softkey to enter the built-in wave menu.
- (3) Press **Common**, **Medical treatment**, **Standard** softkeys to select the built-in wave type.
 Press **NextPage** softkey to enter the next page, select the built-in wave type: **Maths**, **Trigonometric**, **Window function**.
 Press **NextPage** softkey to enter the next page, select the built-in wave type: **Engineering**, **Seg Mod** (Segmentation Modulation) and **Fan test**.
 For example, select **Common** to enter the interface shown below.



- (4) Turn the **knob** to select the desired waveform, for example, select **DC**. Press the **OK** softkey to enter the Arbitrary function.

Note: DC is a type of built-in waveform, located in the **Common** type, named "DC".

Built-in wave list

5. Panel Operation

Name	Description
Common	
DC	Direct current
AbsSine	Absolute sine
AbsSineHalf	Absolute half-sine
AmpALT	Gain oscillation curve
AttALT	Attenuation oscillation curve
GaussPulse	Gauss pulse
NegRamp	Negative ramp
NPulse	Negative pluse
PPulse	Positive pluse
SineTra	Sine-Tra wave
SineVer	Sine-Ver wave
StairDn	Stair downward
StairUD	Stair upward/downward
StairUp	Stair upward
Trapezia	Trapezia
Medical treatment	
Heart	Heart
Cardiac	Cardiac
LFPulse	Low frequency pulse electrotherapy waveform
Tens1	Neuroelectric stimulation therapy waveform 1
Tens2	Neuroelectric stimulation therapy waveform 2
Tens3	Neuroelectric stimulation therapy waveform 3
EOG	Electrooculogram
EEG	electroencephalogram
Pulseilogram	Ordinary pulse curve
ResSpeed	Ordinary expiratory flow rate curve
Standard	
Ignition	Automobile internal combustion engine ignition waveform
TP2A	Automotive transients due to inductance in the wiring
ISP	Automobile starting profile with oscillation
VR	Working voltage profile of the car when resetting
TP1	Automotive transients due to power cuts
TP2B	Car transients due to startup switching off
TP4	Car working profile during start-up
TP5A	Car transients due to the power cut of battery
TP5B	Car transients due to the power cut of battery
SCR	Sintering temperature release map
Surge	Surge signal
Maths	
Airy	Airy function
Besselj	Type I Bessel function

5.Panel Operation

Bessely	Type II Bessel function
Cauchy	Cauchy distribution
X^3	Cubic function
Erf	Error function
Erfc	Remnant error function
ErfcInv	Anti-complement error function
ErfInv	Inverse error function
Dirichlet	Dirichlet function
ExpFall	Exponential decline function
ExpRise	Exponential rise function
Laguerre	Four Laguerre polynomials
Laplace	Laplace distribution
Legend	Five Legendre polynomials
Gauss	Gaussian distribution, also known as the normal distribution
HaverSine	Semi-positive function
Log	Base 10 logarithmic function
LogNormal	Lognormal distribution
Lorentz	Lorentz function
Maxwell	Maxwell distribution
Rayleigh	Rayleigh distribution
Versiera	Tongue line
Weibull	Weber distribution
Ln(x)	Natural logarithmic waveform
X^2	Square function
Round	Round wave
Chirp	Linear frequency modulation
Rhombus	Diamond wave
Trigonometric function	
CosH	Hyperbolic cosine
Cot	Cotangent function
CotH	Hyperbolic cotangent
CotHCon	Concave hyperbolic cotangent
CotHPro	Raised hyperbolic cotangent
CscCon	Recessed cosecant
Csc	Cosecant
CscPro	Raised cosecant
Csch	Hyperbolic cosecant
CschCon	Depressed hyperbolic cosecant
CschPro	Raised hyperbolic cosecant
RecipCon	Reciprocal of the depression
RecipPro	Raised countdown
SecCon	Depression secant
SecPro	Raised secant

5. Panel Operation

SecH	Hyperbolic secant
Sinc	Sinc function
SinH	Hyperbolic sine
Sqrt	Square root function
Tan	Tangent function
TanH	Hyperbolic tangent
ACos	Inverse cosine function
ACosH	Inverse hyperbolic cosine function
ACot	Anti-cotangent function
ACotCon	Inverse cotangent function
ACotPro	Raised inverse cotangent function
ACotH	Inverse hyperbolic cotangent function
ACotHCon	Inverse hyperbolic cotangent function
ACotHPro	Raised inverse hyperbolic cotangent function
Acsc	Anti-cosecting function
ACscCon	Concave inverse cosecting function
ACscPro	Raised anti-cosecting function
AcscH	Anti-hyperbolic cosecant
ACscHCon	Inverse hyperbolic cotangent function
ACscHPro	Raised inverse hyperbolic cosecant function
Asec	Inverse cut function
ASecCon	Inverse tangent function
ASecPro	Raised arctangent function
ASecH	Inverse hyperbolic secant function
ASin	Inverse sine function
ASinH	Inverse hyperbolic sine function
ATan	Arc tangent function
ATanH	Inverse hyperbolic tangent function
Window function	
Bartlett	Bartlett window
BarthannWin	Modified Bartlett window
Blackman	Blackman window
BlackmanH	BlackmanH window
BohmanWin	BohmanWin window
Boxcar	Rectangular window
ChebWin	Chebyshev window
FlattopWin	Flat top window
Hamming	Hamming window
Hanning	Hanning window
Kaiser	Kaiser window
NuttallWin	The smallest four Blackman-Harris windows
ParzenWin	Parzen window
TaylorWin	Taylaor window

5. Panel Operation

Triang	Triangle window, also call Fejer window
TukeyWin	Tukey window
Engineering Window	
Butterworth	Butterworth filter
Combin	Combined function
CPulse	C-Pulse signal
CWPulse	CW pulse signal
RoundHalf	Half-round wave
BandLimited	Band limited signal
BlaseiWave	Blasting vibration "time-vibration speed" curve
Chebyshev1	Type I Chebyshev filter
Chebyshev2	Type II Chebyshev filter
DampedOsc	Damped oscillation "time-displacement" curve
DualTone	Dual audio signal
Gamma	Gamma signal
GateVibar	Gate self-vibration signal
LFMPulse	Chirp signal
MCNoise	Mechanical construction noise
Discharge	NiMH battery discharge curve
Quake	Seismic wave
Radar	Radar signal
Ripple	Ripple
RoundsPM	RoundsPM wave
StepResp	Step response signal
SwingOsc	Swing oscillation kinetic energy-time curve
TV	TV signal
Voice	Voice signal
Segement Modulation	
AM	Sinusoidal segmented AM wave
FM	Sinusoidal segmented FM wave
PM	Sinusoidal segmented PM wave
PWM	Pulse width segmented PWM wave
Fan test	
64n/1024	Order adjustment (n is an integer, the range is 0 - 16)

File Sore Syetem

Supports communication with a computer via a USB port. Using the Waveform Editor software installed on the computer, the signal generator can be operated on the computer to control the output and write the file to the signal generator.

The instrument settings can be saved as files in internal memory. Up to 16 instrument settings can be saved in the instrument internal memory.

Note: Please go to our official website to obtain the Waveform Editor communication software and install it.

Communication with PC

- (1) **Set the USB device protocol type of the signal generator:** Press **Utility** → **System** → **USBDev**, switch to PC.
- (2) **Connection:** Connect the USB Device interface on the rear panel of the signal generator to the **USB interface** of the computer with a USB cable.
- (3) **Install the driver:** Run Waveform Editor software on the computer. Follow the instructions to install the driver. The path of the driver is the USBDRV folder in the directory where the Waveform Editor communication software is located, such as "C:\Program Files (x86)\DS_Wave\Waveform Editor\USBDRV".
- (4) **Host computer communication port setting:** Open the Waveform Editor software, click "Communications" in the menu bar, select "Ports-Settings", in the setting dialog box, select the communication port as "USB". After the connection is successful, the connection status prompt in the lower right corner of the software interface turns green.

Reading waveform

- (1) Please visit our official website to obtain the installation package and decompress it.
- (2) Double click "Waveform Editor.exe" icon to run the software.

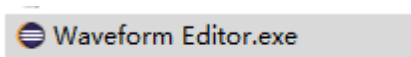

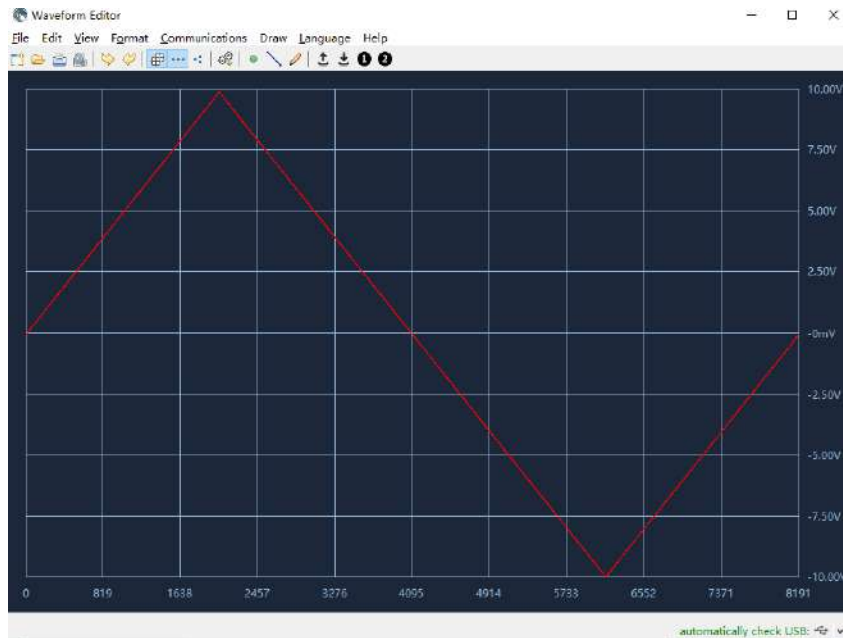

- (3) Enter the "Waveform Editor" interface.
- (4) Select the required waveform on the instrument.
- (5) Under Waveform Editor software interface, click "Read Waveform Icon  " button, and the waveform will be readed and displayed on the screen.



Write and Recall waveform

We can use the Line Draw, Hand Draw and Point Edit mode in the Waveform Editor to edit the required waveform, and save and display it on the instrument by writing.

- (1) Under Waveform Editor software interface, Click "Write waveform Icon  " button.
- (2) After the writing is successful, the "File transfer completed" prompt box will be displayed in the waveform editor. Click "OK".
- (3) On the instrument, the screen shows "Any wave has been updated to USERX(X is 0-15)".
- (4) Press the  Arb Wave button ,then press the **NextPage** button to enter the nextpage menu.
- (5) Press the **Store** soft key to enter the file system, and then press the **Enter** soft key to enter the file system. Select the file name "USERX" that has just written the waveform.
- (6) Press the **Call out** soft key, the screen displays "File read successfully", then press the  arbitrary wave key, the written waveform can be viewed on the instrument.

Note: The file size is displayed on the right of the file. If 0B is displayed, the file is empty.

Generate Sweep (Sweep)

In sweep mode, the generator varies its output from the start frequency to the stop frequency within the specified sweep time. Sweep can be generated by **Sine**, **Square**, **Ramp** or **Arbitrary** wave (except DC).

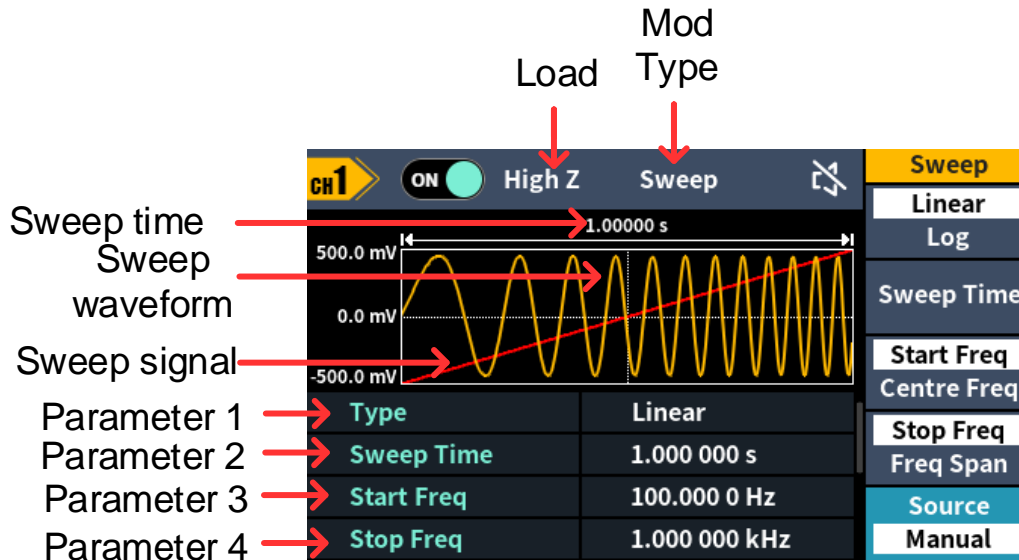







Figure 5-11: Sweep mode user interface

How to set the parameters of Sweep

- (1) When the output signal is **Sine**, **Square**, **Ramp** or **Arbitrary** wave (except DC), press the front panel **Mode** function key, then press the **Sweep** to enter the sweep mode.
- (2) Press , , , or  to select the sweep waveform. For example, when selecting a sine wave, press  to display the sweep waveform and parameters, and change the parameters. For details, please refer to *Output Sine Wave* on page 8. Press the **Mode** to return to the sweep mode interface.
- (3) Press the **Type** softkey to switch the sweep type.

When **Linear** is selected, the output frequency of the instrument varies linearly during the sweep.

When **Log** is selected, the output frequency of the instrument varies in a logarithmic fashion during the sweep.

When **Step** is selected, the output frequency of the instrument steps from start frequency to stop frequency. The duration of the output signal on each frequency point is determined by sweep time and step number. Press the **Step** softkey to set the desired step number.
- (4) Press the **Sweep Time** softkey to set the sweep time, the time span of the

sweep for which the frequency changes from the start frequency to stop frequency. The range is from 1ms to 500s.

- (5) Start frequency and stop frequency are the upper and lower limits of the frequency for frequency sweep. The generator sweeps from the start frequency to the stop frequency and then returns back to the start frequency. Press the **StartFreq/CtrFreq** softkey to highlight **StartFreq**, note that **StopFreq** in **StopFreq/FreqSpan** is also highlighted, input the desired frequencies.

You can also set the frequency boundaries of frequency sweep through center frequency and frequency span.

$$\text{Center Frequency} = (\text{Start Frequency} + \text{Stop Frequency}) / 2$$

$$\text{Frequency Span} = \text{Stop Frequency} - \text{Start Frequency}$$

Press the **StartFreq/CtrFreq** softkey to highlight **CtrFreq**, note that **FreqSpan** in **StopFreq/FreqSpan** is also highlighted, input the desired frequencies.

For different instrument models and different waveforms, the setting ranges of frequency are different. For detailed information, please refer to **Sweep characteristics** in *Specification* on page 38.

- (6) Press the **source** softkey to select the trigger source.

Internal means using the internal trigger source.

Manual means using manual trigger. In sweep interface, each time you press the **knob** under the current channel on the front panel, a sweep will be generated.

Generate Burst (Burst)

Burst pulse train can produce a variety of waveform functions of the pulse train waveform output. Burst can last for certain times of waveform cycle (N-Cycle Burst). Burst can apply to **Sine**, **Square**, **Ramp**, **Pulse** and **Arbitrary** waveforms(except DC).

Glossary

Burst:

The set of pulses transmitted together is called a "burst". The various signal generators are commonly referred to as the BURST function.

N cycle burst:

Contains a specific number of waveform cycles, each of which is initiated by a trigger event.

The waveform of the cyclic pulse train refers to the waveform of the specified number of cycles output after the signal generator receives the trigger signal

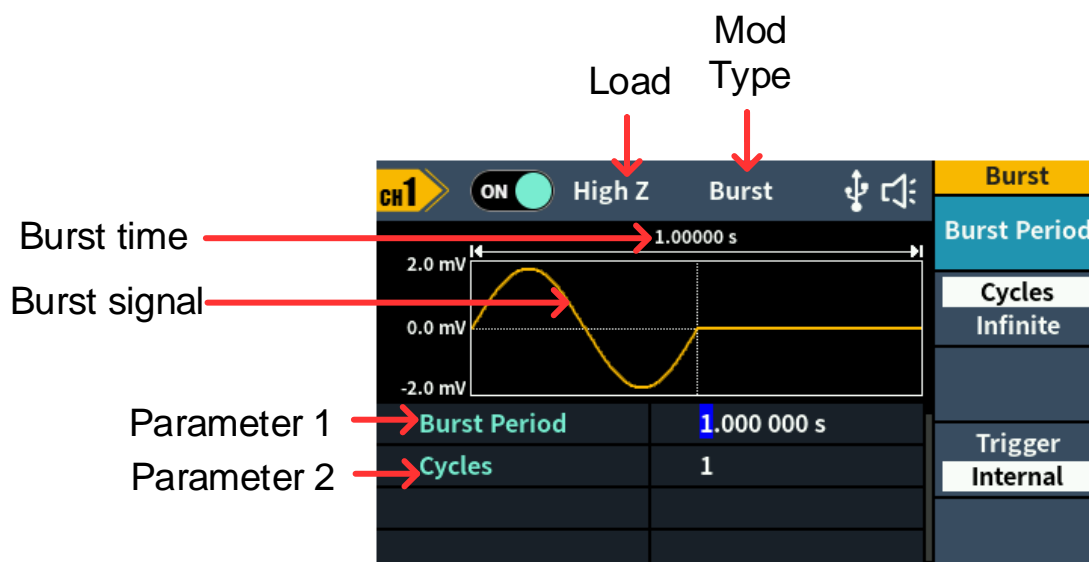







Figure 5-12: N-Cycle burst user interface



(1) When the output signal is **Sine**, **Square**, **Ramp**, **Pulse** or **Arbitrary** wave (except DC), press the front panel **Mode** function key, then press the **Burst** to enter the burst mode.

(2) Press , , , , or  to select the burst waveform. For example, when selecting a sine wave, press  to display the burst waveform and parameters, and change the parameters. For details, please refer to *Output Sine Wave* on page 8. Press the **Mode** to return to the burst mode interface.

Note: Before configuring the waveform parameters, you must first select the channel you want to configure. Press **CH1/CH2** to select the corresponding channel, and the corresponding channel area in the user interface will light up.

(3) Press the **Cycles/Infinite** softkey to highlight **Cycles**, input the number of cycles, which is the number of waveform cycles to be output for each N-cycle pulse train. The range is from 1 to 60 000.

When **Infinite** is selected, the cycle number of the waveform is set as an infinite value. The generator outputs a continuous waveform after receiving trigger signal.

Note: In burst mode, the upper limit of the carrier frequency is half of the max frequency of the original carrier. Taking a Sine wave as an example, the maximum frequency is 70 MHz. Press , and set the carrier to 70 MHz, then press the **Mode** mode key, then press , you can see the carrier frequency is changed to 35MHz.

Note:

- If needed, Burst Period will increase to cater to the specific number of cycles.
 - For an infinite-cycle Burst, **External** or **Manual** Trigger is needed to activate burst.
-

- (4) Burst trigger source could be internal, external or manual. The generator will generate a burst output when a trigger signal is received and then wait for the next trigger. Press the **Trigger** to select the source.

Internal means using the internal trigger source. The generator can only output N-cycle burst and the burst frequency is determined by the burst period. Burst period is only available when **Cycles** and **Internal** trigger is highlighted. Press the **Burst Period** softkey to set the burst period, which is the time from the start of a burst to the start of the next burst. The range is from 20 ns to 500 s (Min = Cycles * Period).

Manual means using manual trigger. In N-cycle burst interface, each time you press the **Knob** under the current channel on the front panel, a burst will be generated.

Output the Modulated Waves

Supported modulation types include: AM (Amplitude Modulation), FM (Frequency Modulation), PM (Phase Modulation), FSK (Frequency Shift Keying).

Press the **Mode** function key, select the modulation type, to enter the setup menu. To turn off the modulation, press the **Mode** function button again.

Note: The following output modulation waveform uses CH1 as an example. If you need to set CH2, please refer to CH1 operation.

AM (Amplitude Modulation)

The modulated waveform consists of the carrier wave and the modulating wave. For AM, the amplitude of the carrier wave varies with the instantaneous voltage of the modulating wave. The AM user interface is shown below.

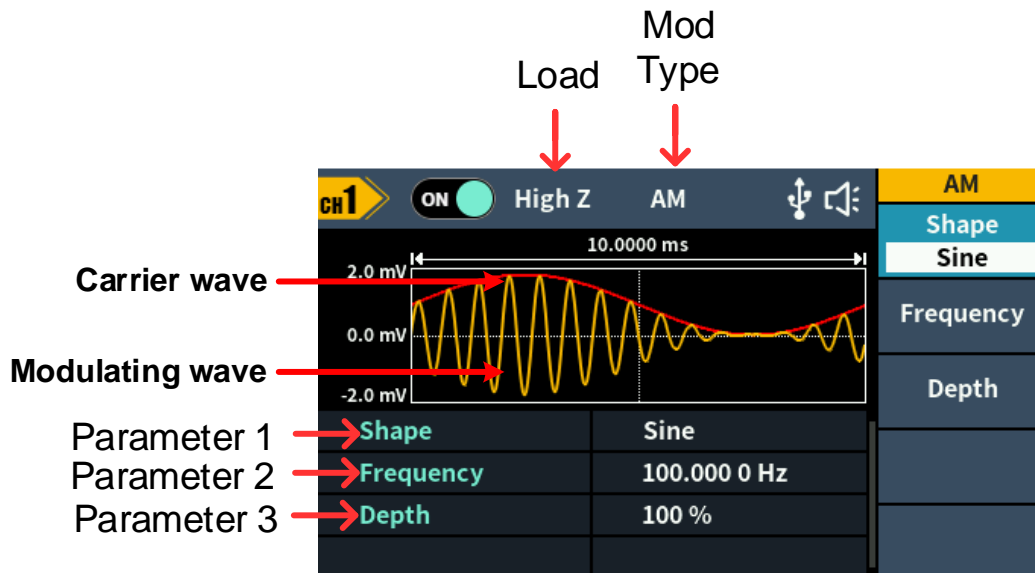





Figure 5-13: AM user interface

How to set the parameters of AM

- (1) Press the **Mode** function key, then press the **AM** softkey to enter the AM user interface.
- (2) **Select carrier wave shape:**
The carrier wave can be **Sine**, **Square**, **Ramp**, or **Arbitrary** wave (except DC). Press , , , or  to select a desired carrier wave shape.
- (3) **Set carrier wave parameters:**
Press the **wave shape key** of the selected carrier wave to display the waveform and parameters of the carrier wave. You can change the parameters of the carrier wave. Press **Mode** to return to the modulation mode interface.
- (4) **Select modulating wave shape:**
Press the **Shape** softkey, then press the **Sine**, **Square**, **Ramp**, **Noise**, or **Arb** softkey to select the modulating wave.
- (5) **Set modulating wave frequency:**
Press the **Frequency** softkey to set the modulating wave frequency. The range is 2 mHz – 1 MHz (for internal source only).
- (6) **Set modulation depth:**
Press the **Depth** softkey to set the modulation depth. The range is 0% - 100%.

Glossary

AM frequency

The frequency of the modulating waveform.

Modulation Depth

The amplitude range of modulating waveform. In 0% modulation, the output amplitude is half of the specified value. In 100% modulation, the output amplitude is equal to the specified value. For an external source, the depth of AM is controlled by the voltage level of the signal connected to the **Mod/FSK/Trig** connector at the rear panel. +1 V corresponds to the currently set depth 100%.

FM (Frequency Modulation)

The modulated waveform consists of the carrier wave and the modulating wave. For FM, the frequency of the carrier wave varies with the instantaneous voltage of the modulating wave. The FM user interface is shown below.

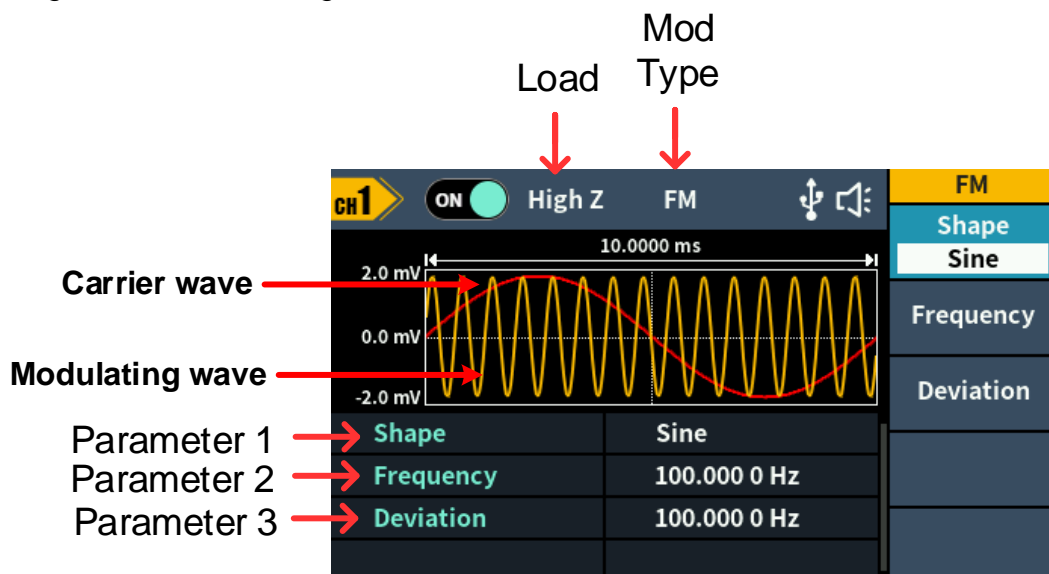





Figure 5-14: FM user interface

How to set the parameters of FM

- (1) Press the **Mode** function key, then press the **FM** softkey to enter the FM user interface.
- (2) **Select carrier wave shape:**
The carrier wave can be **Sine**, **Square**, **Ramp**, or **Arbitrary** wave (except DC). Press , , , or  to select a desired carrier wave shape.
- (3) **Set carrier wave parameters:**
Press **the wave shape key** of the selected carrier wave to display the waveform and parameters of the carrier wave. You can change the

parameters of the carrier wave. Press **Mode** to return to the modulation mode interface.

(4) **Select modulating wave shape:**

Press the **Shape** softkey, then press the **Sine**, **Square**, **Ramp**, **Noise**, or **Arb** softkey to select the modulating wave.

(5) **Set modulating wave frequency:**

Press the **Frequency** softkey to set the modulating wave frequency. The range is 2 mHz – 1 MHz (for internal source only).

(6) **Set frequency deviation:**

Frequency deviation is the deviation of the modulating wave frequency relative to the carrier wave frequency. Press the **Deviation** softkey to set the FM frequency deviation. Frequency deviation range: $1 \mu\text{Hz} \leq \text{deviation} < \text{upper limit}$ (upper limit is **carrier frequency** or **carrier maximum frequency minus carrier frequency**, the smaller of the two).

PM (Phase Modulation)

The modulated waveform consists of the carrier wave and the modulating wave. For PM, the phase of the carrier wave varies with the instantaneous voltage of the modulating wave. The PM user interface is shown below.

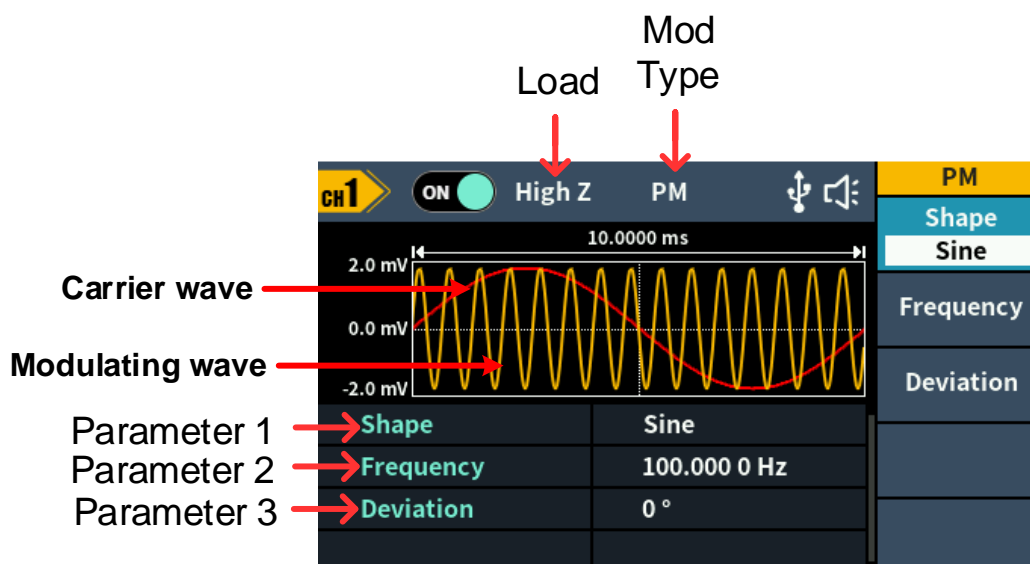





Figure 5-15: PM user interface

How to set the parameters of PM

- (1) Press the **Mode** function key, press the **NextPage** softkey, then press the **PM** softkey to enter PM user interface.
- (2) **Select carrier wave shape:**

The carrier wave can be **Sine**, **Square**, **Ramp**, or **Arbitrary** wave (except DC). Press , , , or  to select a desired carrier wave shape.

(3) Set carrier wave parameters:

Press **the wave shape key** of the selected carrier wave to display the waveform and parameters of the carrier wave. You can change the parameters of the carrier wave. Press **Mode** to return to the modulation mode interface.

(4) Select modulating wave shape:

Press the **Shape** softkey, then press the **Sine**, **Square**, **Ramp**, **Noise**, or **Arb** softkey to select the modulating wave.

(5) Set modulating wave frequency:

Press the **PM Frequency** softkey to set the modulating wave frequency. The range is 2 mHz – 1 MHz (for internal source only).

(6) Set phase deviation:

Phase deviation is the deviation of the modulating wave phase relative to the carrier wave phase. Press the **Deviation** softkey to set the PM phase deviation. The range of phase deviation is from 0° to 180°.

FSK (Frequency Shift Keying)

Frequency Shift Keying modulation is a modulation technique that shifts the output signal frequency between two frequencies: the carrier frequency and hop frequency. The shift frequency (FSK rate) is determined by the internal signal level. The FSK user interface is shown below.

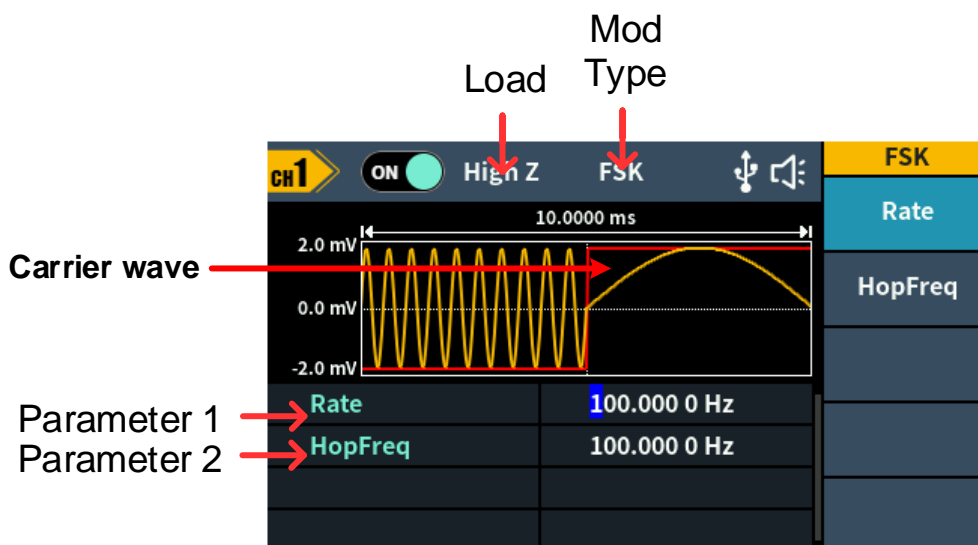





Figure 5-16: FSK user interface

How to set the parameters of FSK



- (1) Press the **Mode** function key, press the **NextPage** softkey, then press the **PM** softkey to enter FSK user interface.
- (2) **Select carrier wave shape:**
The carrier wave can be **Sine**, **Square**, **Ramp**, or **Arbitrary** wave (except DC). Press , , , or  to select a desired carrier wave shape.
- (3) **Set carrier wave parameters:**
Press the **wave shape key** of the selected carrier wave to display the waveform and parameters of the carrier wave. You can change the parameters of the carrier wave. Press **Mode** to return to the modulation mode interface.
- (4) **Press the Rate** softkey to set the FSK rate. The rate at which the output frequency shifts between the carrier frequency and the hop frequency is determined by FSK rate. The range is 2 mHz – 1 MHz.
- (5) **Set hop frequency:**
Press the **Hop Frequency** softkey to set the hop frequency. The carrier wave frequency shifts to the hop frequency with the specified FSK rate, and then returns to the original frequency.

Utility Function Setting

Press the front panel **Utility** function key to enter the utility menu. You can set the parameters of the generator such as: display settings, CH1/2 settings, and system settings. Press **Utility** again to exit the utility menu.

Display Settings

Brightness Control

- (1) Press the front panel **Utility** function key, press the **Display** softkey.
- (2) Press the **Backlight** softkey to select **Backlight**.
- (3) Turn the **knob** to adjust the value on the current cursor, use the / direction key to move cursor left or right, or use the **numeric keypad** to enter the parameter and then select % as unit. The range is from 0% to 100%.

Screen Saver

If there is no operation within the set screen saver time, the screen enters the protection mode (minimize screen brightness to protect the screen and save energy). Press any key (except the power button) to restore the brightness before entering the screen saver.

- (1) Press the front panel **Utility** function key, press the **Display** softkey.
- (2) Press the **ScrSaver** softkey to select **On** or **Off**.
- (3) At **On** status, you can set the screen saver time. Turn the **knob** to adjust the value on the current cursor, use the **←/→** direction key to move cursor left or right, or use the **numeric keypad** to enter the parameter and then select Minute as unit. The screen saver time range is 1 to 999 minutes.

Separator

The user can set the separator of the screen display data.

- (1) Press the front panel **Utility** function key, press the **Display** softkey.
- (2) Press the **Separator** softkey to toggle between **Comma**, **Space**, and **Nothing**.

Taking the frequency parameter as an example:

Comma **1.000,000,0**

Space **1.000 000 0**

Nothing **1.0000000**

CH1/2 Settings

Load

For either of **Out1** and **Out2** connector at the front panel, the generator has a 50Ω fixed serial output impedance. If the actual load does not match the specified value, the voltage level displayed would not match the voltage level of the component under test. This function is used to match the displayed voltage with the expected one.

The step to set the CH1 or CH2 load value is as follows:

- (1) Press the **Utility** function key, press the **CH1/2 Set** softkey.
- (2) Press the **CH1 Load** or **CH2 Load** softkey, press it again to select **High Z** or * **ohm** ("*" represents a value, the default is 50Ω).
- (3) To change the load value, after selecting * **ohm**, turn the **knob** to adjust the value on the current cursor, use the **←/→** direction key to move cursor left or right, or use the **numeric keypad** to enter the parameter and then select unit. The load range is 1ohm to 10kohm.

Warning: Setup the correct load for right application.

Align Phase : Select **Align Phase** in the bottom menu to align the initial phase

of two channel signals.

System Settings

Language

- (1) Press the front panel **Utility** function key, press the **System** softkey.
- (2) Press the **Language** softkey to switch the display language.

Beeper

When the beeper is turned on, the beeper sounds when users operate the front panel or when an error occurs.

- (1) Press the front panel **Utility** function key, press the **System** softkey.
- (2) Press the **Beeper** softkey to toggle between **On** or **Off**.

USB Device Type

The user can set the communication protocol type of the USB Device interface at the rear panel.

- (1) Press the front panel **Utility** function key.
- (2) Press the **USBDEV** softkey to toggle between **PC** and **USBTMC**.
 - **PC**: This is the internal communication protocol. Select this option when connecting to the Waveform Editor software via the USB Device interface.
 - **USBTMC**: Select this option when you need to use the USBTMC communication protocol standard.

Restore to the factory setting

- (1) Press the front panel **Utility** function key, select **System** softkey, then press the **Nextpage** softkey.
- (2) Press the **Factory Set** softkey, and then press the **OK** softkey to restore the generator to the factory default settings.

Table 5-1: The factory default settings

Output Configuration	Factory Setting
CH1 signal output switch	Off
CH2 signal output switch	Off
Function	Sine
Frequency	1 kHz

5. Panel Operation

Amplitude/Offset	1 Vpp / 0 Vdc
Basic Waveform	Factory Setting
Frequency	1 kHz
Period	1 ms
Amplitude	1 Vpp
Offset	0 V
High Level	500 mV
Low Level	-500 mV
Phase	0°
Ramp Wave Symmetry	50%
Pulse Width	200 us
Pulse Duty Cycle	20%
Pulse Rising Time	1.953125 us
Pulse Falling Time	1.953125 us
Build-in Wave	X ²
Modulation Waveform	Factory Setting
Modulation type	AM
AM	
Modulating Waveform	Sine
AM Frequency	100 Hz
Modulation Depth	100%
FM	
Modulating Waveform	Sine
FM Frequency	100 Hz
Frequency Deviation	100 Hz
PM	
Modulating Waveform	Sine
PM Frequency	100 Hz
Phase Deviation	0°
FSK	
FSK Rate	100 Hz
Hop Frequency	100 Hz
Sweep	Factory Setting
Sweep Time	1 s

Sweep Type	Linear
Start Frequency	100 Hz
Stop Frequency	1 kHz
Center Frequency	550 Hz
Frequency Span	900 Hz
Burst	Factory Setting
Burst Period	1 s
Number of Cycles	1
Trigger Source	Internal
Utility	Factory Setting
Backlight	50%
Screen Saver	On
Screen Saver Time	30 Minute
Thousand Separator	Space
CH1 load	High Z
CH2 load	High Z
USB device	USB TMC
Language	Factory Delivery Setting
Beeper	On

Firmware Update

Use the rear-panel USB port to update your instrument firmware using a USB memory device.

Caution: Updating your instrument firmware is a sensitive operation, to prevent damage to the instrument, do not power off the instrument or remove the USB memory device during the update process.

To update your instrument firmware, do the following:

1. Press the **Utility** button,press the **System** softkey,press **Nextpage** to next page,press **Upgrade** ,the instrument weill have a prompt message.
2. Press the **OK** button,the external disk icon is displayed on the PC .
3. Visit the company's website on the PC and select the required instrument firmware upgrade package for the corresponding model. Download the " AG. upp " file in the firmware upgrade package to the PC, and copy the firmware to the external disk that is displayed.
4. Restart the device. After the device is powered on, the upgrade status is

displayed.

5. After finished the upgrade, the instrument will shut down automatically.
6. Press the  button to power on the instrument(Press **Utility** to check whether the version is the desired target version)

6. Troubleshooting

1. The screen is still black and there is no display after you press the power switch, please follow the steps below:

- Check whether the power is connected correctly.
- Check whether the fuse below the power connector meets the specified type and rating and in good condition (the cover can be pried open with a flat-blade screwdriver).
- Restart the instrument after completing the above inspections.
- If the problem still exists, please contact us for our service.

2. The measured value of the output signal amplitude does not match the displayed value:

Check whether the actual load value of the signal is consistent with the load value set in the instrument. Please refer to CH1/2 Settings on page 33.

If you encounter other problems, please try to restart the instrument. If it still can not work properly, please contact us for our service.

7. Specification

All technical specifications are guaranteed when the following conditions are met, unless otherwise stated.

- The signal generator must be operated continuously for more than 30 minutes at the specified operating temperature (20°C to 30°C) to meet these specifications;
- The signal generator is in the calibration internal and has performed a self-calibration.

In addition to the specifications marked with the word "Typical", the specifications used are guaranteed.

Waveforms

Waveforms		
Bandwidth	DGE2035	35 MHz
	DGE2070	70 MHz
Sample Rate	DGE2035	125MSa/s
	DGE2070	300MSa/s
Vertical Resolution	14 bits	
Channel	2	
Standard Waveforms	Sine wave, square wave, ramp wave, pulse wave, noise	
Arbitrary Waveforms	Sinc, exponential rise, exponential decline, electrocardiogram, Gaussian, semi-positive, Lorentz, dual audio, DC voltage totaling more than 150 kinds	

Frequency Characteristics

Frequency Characteristics (Frequency resolution to 1 μ Hz)		
Sine wave	DGE2035	1 μ Hz ~ 35MHz
	DGE2070	1 μ Hz ~ 70MHz
Square wave	DGE2035	1 μ Hz ~ 15MHz
	DGE2070	1 μ Hz ~ 20MHz
Pulse wave	DGE2035	1 μ Hz ~ 15MHz
	DGE2070	1 μ Hz ~ 20MHz
Ramp wave	DGE2035	1 μ Hz - 1 MHz
	DGE2070	1 μ Hz - 2 MHz
Noise wave (-3 dB)	20 MHz BW (AWGN)	
Arbitrary wave	1 μ Hz - 10 MHz	
Frequency resolution	1 μ Hz or 7 significant figures	

7.Specification

Frequency stability	± 30 ppm at $0 \pm 40^\circ\text{C}$
Frequency aging rate	± 30 ppm per year

Amplitude Characteristics

Amplitude Characteristics (not specifically labeled, the load defaults to 50 Ω)		
Output amplitude	DGE2035	2mVpp ~ 20Vpp ($\leq 10\text{MHz}$) High Z 2mVpp ~ 10Vpp ($\leq 35\text{MHz}$) High Z 1mVpp ~ 10Vpp ($\leq 10\text{MHz}$) 50 Ω 1mVpp ~ 5Vpp ($\leq 35\text{MHz}$) 50 Ω
	DGE2070	2mVpp ~ 20Vpp ($\leq 10\text{MHz}$) High Z 2mVpp ~ 10Vpp ($\leq 70\text{MHz}$) High Z 1mVpp ~ 10Vpp ($\leq 10\text{MHz}$) 50 Ω 1mVpp ~ 5Vpp ($\leq 70\text{MHz}$) 50 Ω
Amplitude accuracy	\pm (1% of setting + 1 mVpp) (Typical 1kHz sine, 0V offset)	
Amplitude resolution	1mVpp or 4 digits	
DC offset range (AC +DC)	DGE2035	$\pm(10 \text{ Vpk} - \text{Amplitude Vpp}/2)$ High Z ($\leq 10\text{MHz}$) $\pm(5\text{Vpk} - \text{Amplitude Vpp}/2)$ High Z ($\leq 35\text{MHz}$) $\pm(5 \text{ Vpk} - \text{Amplitude Vpp}/2)$ 50 Ω ($\leq 10\text{MHz}$) $\pm(2.5 \text{ Vpk} - \text{Amplitude Vpp}/2)$ 50 Ω ($\leq 35\text{MHz}$)
	DGE2070	$\pm(10\text{Vpk} - \text{Amplitude Vpp}/2)$ High Z ($\leq 10\text{MHz}$) $\pm(5\text{Vpk} - \text{Amplitude Vpp}/2)$ High Z ($\leq 70\text{MHz}$) $\pm(5 \text{ Vpk} - \text{Amplitude Vpp}/2)$ 50 Ω ($\leq 10\text{MHz}$) $\pm(2.5 \text{ Vpk} - \text{Amplitude Vpp}/2)$ 50 Ω ($\leq 70\text{MHz}$)
DC offset accuracy	\pm (1 % of setting + 1 mV + amplitude Vpp * 0.5%)	
Offset resolution	1 mVpp or 4 digits	
Output Impedance	50 Ω (Typical)	

Signal Characteristics

Signal Characteristics	
Sine	
Bandwidth flatness (relative to 1 kHz Sine wave, 1 Vpp)	$\leq 10\text{MHz}$: $\pm 0.3\text{dB}$ $\leq 35\text{MHz}$: $\pm 0.5\text{dB}$ $\leq 70\text{MHz}$: $\pm 1\text{dB}$
Harmonic distortion	Typical (0dBm) DC to 1MHz: $< -65\text{dBc}$ 1MHz to 35MHz: $< -60\text{dBc}$ 35MHz to 60MHz: $< -50\text{dBc}$
Total harmonic distortion	$< 0.2\%$, 10 Hz to 20 kHz, 1 Vpp
Non-harmonic distortion	Typical (0dBm) $\leq 10\text{MHz}$: $< -70\text{dBc}$ $> 10\text{MHz}$: $< -70\text{dBc} + 6\text{dB/ sound interval}$

7.Specification

Phase noise	Typical (0dBm, 10kHz offset) 10MHz: ≤ -110 dBc/Hz	
Square		
Rise/fall time	< 20ns	
Jitter (rms), typical (1Vpp, 50 Ω)	200ps + 30ppm	
Overshoot	< 5%	
Ramp		
Linearity	< 1% of peak output (typical 1 kHz, 1 Vpp, symmetry 50%)	
Symmetry	0% to 100%	
Pulse		
Period	DGE2035	67 ns to 1 Ms
	DGE2070	50 ns to 1 Ms
Pulse Width	≥ 24 ns	
Rise and fall time	≥ 15 ns	
Overshoot	< 5%	
Jitter (rms), typical (1Vpp, 50 Ω)	200ps + 30ppm	
Noise		
Types	Gaussian white noise	
Bandwidth (-3dB)	20 M	
Arbitrary wave		
Bandwidth	10M	
Waveform length	2 to 8K points	
Sampling rate	DGE2035	125Ma/s
	DGE2070	300Ma/s
Amplitude accuracy	14 bits	

Modulation Characteristics

Modulation Characteristics	
Modulation Type	AM, FM, PM, FSK
AM	
Carrier	Sine wave, square wave, ramp wave, arbitrary wave (except DC)
Modulated signal source	Internal
Internal modulation waveform	Sine wave, square wave, ramp wave, white noise
Internal amplitude modulation frequency	2 MHz to 100 kHz
Depth	0.0% to 100.0%
FM	

7.Specification

Carrier	Sine wave, square wave, ramp wave, arbitrary wave (except DC)
Modulated signal source	Internal
Internal modulation waveform	Sine wave, square wave, ramp wave, white noise
Internal modulation frequency	2 mHz to 100 kHz
Frequency offset	$1 \mu\text{Hz} \leq \text{offset} < \text{carrier frequency}$
PM	
Carrier	Sine wave, square wave, ramp wave, arbitrary wave (except DC)
Modulated signal source	Internal
Internal modulation waveform	Sine, square, ramp, white noise
Internal phase modulation frequency	2 mHz to 100 kHz
Phase deviation range	0° to 180°
FSK	
Carrier	Sine wave, square wave, ramp wave, arbitrary wave (Except DC)
Modulated signal source	Internal
Internal modulation waveform	50% square wave
FSK rate	2 mHz to 1MHz
FSK hopfreq	$2 \text{ mHz} \leq \text{offset} < \text{maximum frequency of corresponding carrier}$

Sweep Characteristics

Sweep Characteristics	
Carrier	Sine, square wave, ramp wave, arbitrary wave (Except DC)
Minimum/maximum starting frequency	$1 \mu\text{Hz}$ (minimum) / maximum frequency of corresponding carrier
Minimum/maximum termination frequency	$1 \mu\text{Hz}$ (minimum) / maximum frequency of corresponding carrier
Types	Linear, logarithmic
Sweep time	1 ms to $500 \text{ s} \pm 0.1\%$
Trigger source	Internal, manual

Burst Characteristics

Burst Characteristics	
Waveform	Sine wave, square wave, ramp wave, pulse wave and arbitrary wave (Except DC)
Types	N-cycle
N-cycle trigger source	Internal, manual
Carrier frequency	$1 \mu\text{Hz} \leq \text{Offset} \leq \text{Maximum frequency of corresponding carrier} / 2$
N-cycle trigger cycle	DGE2035 58 ns ~ 1 Ms (Min = Cycles * Period)
	DGE2070 29 ns ~ 1 Ms (Min = Cycles * Period)
periodicity	$1 \sim 60000$ (Max = Burst Period / Period) /infinite

Input/Output Characteristics

Input/Output Characteristics	
Communication Interface	USB Device

General Specifications

Display	
Display type	3.6-inch color LCD display
Display resolution	480 Horizontal x272 Vertical pixels
Display color	65536 colors, 16 bits, TFT
Power	
Voltage	DC 5V /3A
Power consumption	Less than 15W
Environment	
Temperature	Working temperature: 0 °C to 40 °C
	Storage temperature: -20 °C to 60 °C
Relative humidity	Less than 35°C: ≤ 90% relative humidity 35°C to 40°C: ≤ 60% relative humidity
Height	Operating 3,000 meters Non-operation 12,000 meters
Mechanical Specification	
Dimension	200mm (Length) x 68.5 mm (Height) x 73.6mm (Width)
Weight	Approx. 0.5 kg
Others	
Adjustment interval	The recommended calibration interval is one year

8. Appendix

Appendix A: Accessories

- 1 xDC power adapter
- 1 x USB power cable
- 1 x Quick Guide
- 1 x BNC/Q9 cable
- 1 x BNC to alligator cable
- 1 x USB communication cable

Appendix B: General Care and Cleaning

General Maintenance

Do not store or leave the instrument where the liquid crystal display will be exposed to direct sunlight for long periods of time.

Caution: To avoid any damage to the instrument or probe, do not exposed it to any sprays, liquids, or solvents.

Cleaning

Inspect the instrument and probes as often as operating conditions require. To clean the instrument exterior, perform the following steps:

1. Wipe the dust from the instrument and probe surface with a soft cloth. Do not make any scuffing on the transparent LCD protection screen when clean the LCD screen.
2. Disconnect power before cleaning your instrument. Clean the instrument with a wet soft cloth not dripping water. It is recommended to scrub with soft detergent or fresh water. To avoid damage to the instrument or probe, do not use any corrosive chemical cleaning agent.

 **Warning:** Before power on again for operation, it is required to confirm that the instrument has already been dried completely, avoiding any electrical short circuit or bodily injury resulting from the moisture.
