

MIDI LOOPER MANUAL v1.1

NOTE: THIS MANUAL FOLLOWS THE IDEAL LEARNING CURVE. PLEASE FOLLOW IT AS YOU SET UP THE MIDI LOOPER AND DO YOUR FIRST LOOPS.



CONTENT

INTRODUCTION

-

SETTING UP

- INITIAL CONNECTION
- SET THE MIDI CHANNELS
- CONNECT AND SELECT YOUR CLOCK SOURCE CHANNELS
- FURTHER CONNECTIONS

LOOPING

- RECORDING INITIAL LOOP
- OVERDUB / OVERWRITE
- ERASE
- CLEARING A LOOP AND MAKING A NEW ONE
- LOOPING FLOW CHART
- MUTE
- PATTERN SELECTION

MODIFYING THE LOOPS

- LENGTH
- QUANTIZE
- VELOCITY
- TRANSPOSE
- STRETCH
- SHUFFLE
- HUMANIZE

EXTERNAL CONTROL

- RETRIGGER
- VELOCITY CV
- TRANSPOSE CV
- RESET
- DIVIDER
- PEDAL CONTROL

LOOPING CCs AND PITCH BEND

-

FIRMWARE UPDATE

-

MIDI IMPLEMENTATION CHART

- RECEIVES
- TRANSMITS
- MIDI THRU

SETUP EXAMPLES

- SETUP EXAMPLE 01
- SETUP EXAMPLE 02
- SETUP EXAMPLE 03
- SETUP EXAMPLE 04
- SETUP EXAMPLE 05

INTRODUCTION

Midilooper is a device that listens to MIDI messages (control information about notes, dynamics and other parameters) and loops them in a similar way an audio looper would loop pieces of audio. However, loops of MIDI messages remain in the control domain, which means a lot of other processes can happen on top of them - timbre modulation, envelope adjustments etc.

Since looping is one of the fastest and most intuitive ways of music-making, we made the controls of the Midilooper quickly accessible to encourage uninterrupted flow.

Midilooper can be synchronized either by MIDI clock or analog clock, or it can also run on its own clock (tap tempo/free running).

Midilooper has 3 voices that can each be assigned to a different MIDI channel, allowing it to control and loop 3 different pieces of gear. Each voice can be individually recorded, muted, overdubbed, or cleared.

Midilooper also offers some basic processing of the recorded information: transposition, velocity locking and shifting, quantization, shuffle, humanization (random variations of velocity), adjusting the length of the loop, or doubling and halving of the playback speed.

In addition, it features CV and trigger inputs to integrate with modular synths: reset, retrigger, velocity, and transpose. It can also be controlled by connecting foot pedals.

MIDI LOOPER V 1.0 RECOGNIZE AND
RECORDS THESE TYPES OF MESSAGES:

MIDI NOTE

MIDI CHANNEL (1-16)
ON OR OFF
NOTE NUMBER (0-127)
VELOCITY (0-127)

MIDI CC

= CONTROL CHANGE
(MOD WHEEL OR KNOBS)
MIDI CHANNEL (1-16)
CONTROL NUMBER (0-127)
CONTROL VALUE (0-127)

MIDI PITCH BEND

MIDI CHANNEL (1-16)
PITCH BEND VALUE
(0-16383)

SPECIAL CCS

SPECIAL TYPE OF CCS
ARE INTERPRETED
DIFFERENTLY:
- SUSTAIN PEDAL
- ALL NOTES OFF ETC.

MIDI AFTERTOUCH

MIDI CHANNEL (1-16)
MIDI AFTERTOUCH (0-127)
ONLY CHANNEL AFTERTOUCH

READS AND INTERPRETS THE REAL TIME
MESSGES (THEY DO NOT HAVE MIDI CHANNEL)

MIDI CLOCK

MIDI STOP

MIDI START

MIDI CONTINUE

SETTING UP

Midilooper listens to all MIDI Channels and forwards MIDI messages only on the MIDI channel assigned to a selected voice. Use buttons A, B, C to select a voice.

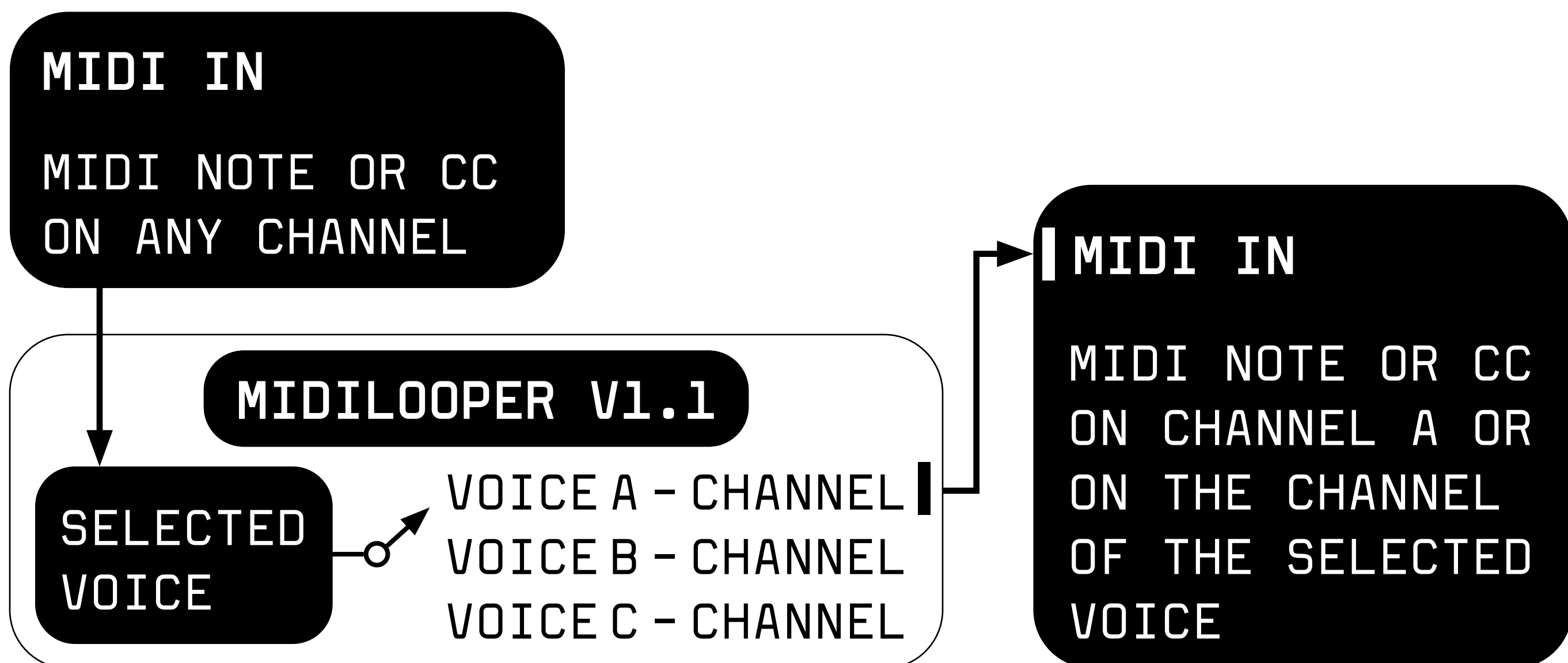

INITIAL CONNECTION

- 1 Connect any keyboard or controller that outputs MIDI to the MIDI Input of the Midilooper.
- 2 Connect the MIDI Out of Midilooper to any synth or sound module that receives MIDI.
- 3 (optional) Connect MIDI Out 2 of the Midilooper to another synth
- 4 Connect USB power to Midilooper

TIP: TO SEE WHETHER YOU ARE RECEIVING MIDI INFORMATION THE FIRST DOT ON THE DISPLAY WILL BLINK (ONLY WHEN THE PLAYER IS STOPPED).

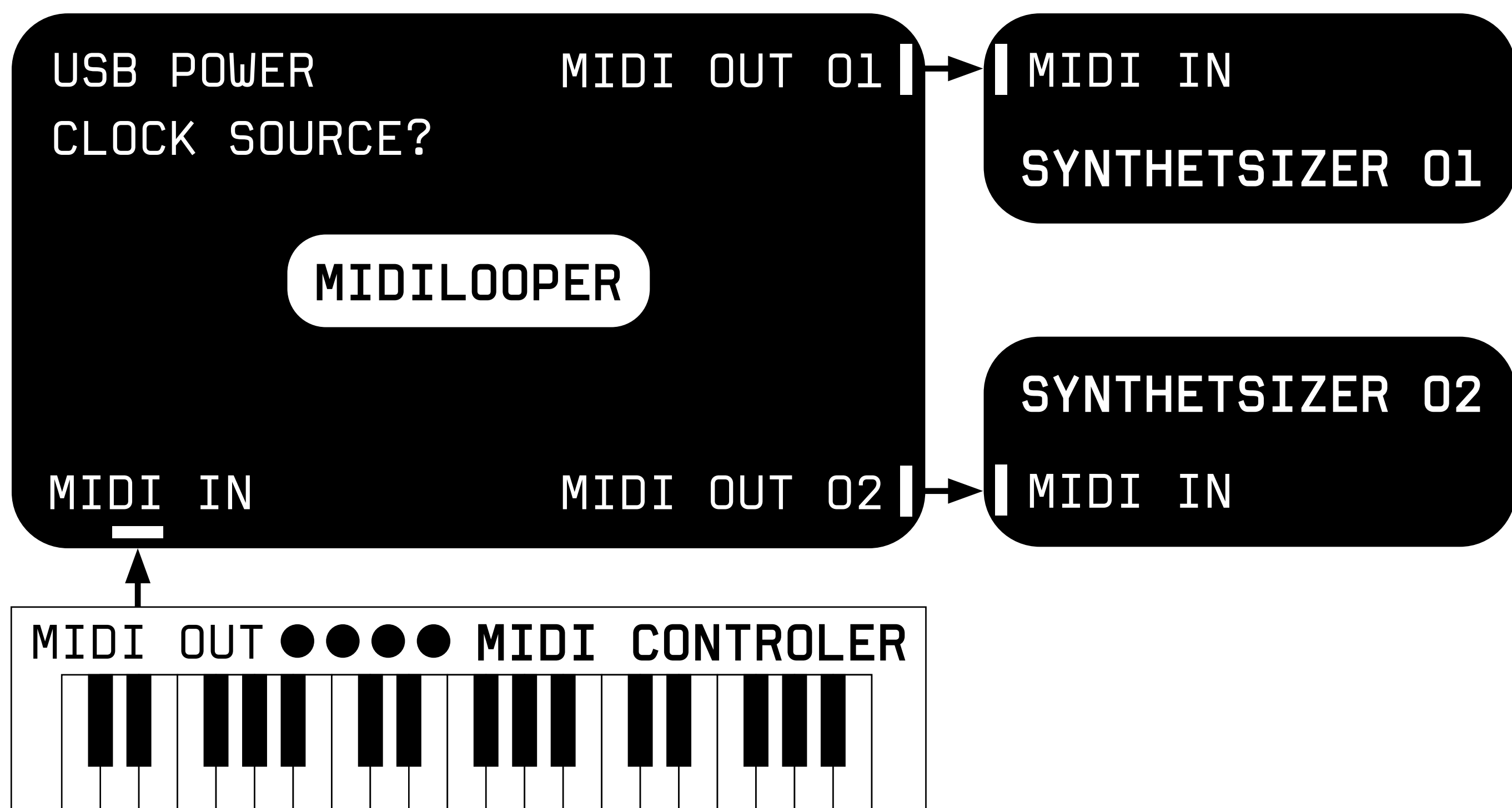

SET THE MIDI CHANNELS

You should know

In button combinations these buttons act as arrows:

REC = UP

PLAY/STOP = DOWN

Voice buttons A, B, and C select the voice. Select voice A by pressing the button and set up its output MIDI channel by holding FN+A+UP/DOWN. The display will show the MIDI channel number.

Set the MIDI input channel on your synth to the same channel.

If done correctly, playing notes on your keyboard should play these notes on your synth. If it does not, check the connections, power and MIDI channel settings on both the Midilooper, and your synth. Follow the same procedure for setting up voice B and C.

TIP: AT THIS POINT YOU MIGHT ALSO WANT TO ADD STATIC OCTAVE OFFSET TO YOUR VOICES (EACH SYNTH YOU MIGHT WANT PLAYING IN A DIFFERENT OCTAVE). TO DO THAT, PRESS FN+TRANSPOSE+VOICE+UP/DOWN

Getting MIDI feedback?

MIDI feedback can occur in some synths when using MIDI In and MIDI Out on the synth. Try disabling MIDI Thru and Local Control on the synth. In case you cannot or don't want to do some of these you can activate the MIDI feedback filter on the Midilooper. While selecting the MIDI channel on the voice that is feedbacking, press the CLEAR button. This will turn on the MIDI FEEDBACK FILTER or in other words: disable the live playback on that particular channel, and only looped material will play back. Changing to any other MIDI channel will reset this feature to its initial off state.

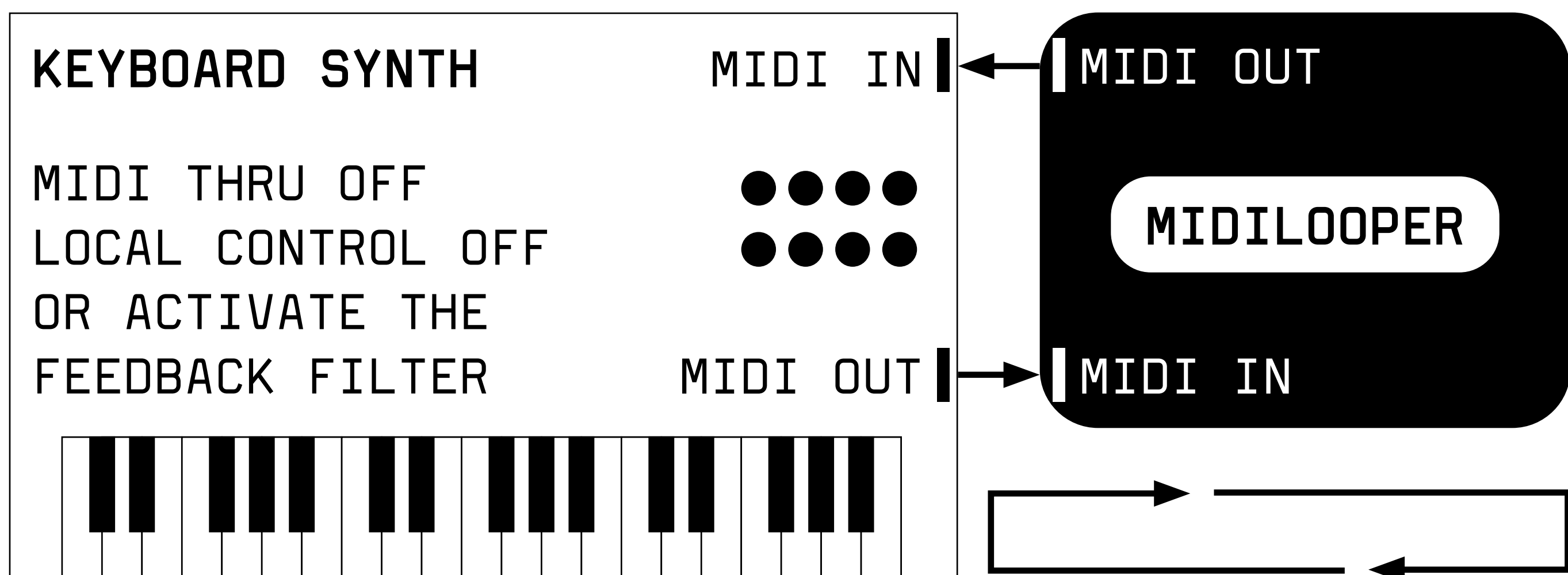

CONNECT AND SELECT YOUR CLOCK SOURCE

There are several options of clocking the Midilooper.

You can select the clock source by FN+PLAY/STOP. The selection cycles in the following order:

- 1 MIDI Clock on MIDI Input (display arrow pointing to MIDI In)
- 2 Analog clock on Clock Input (REC LED On)*
- 3 MIDI Clock on Clock Input (REC LED blinking) - you might need MIDI to mini jack adaptor to use this option**
- 4 Tap tempo (Clear LED On) - tempo set by FN+CLEAR = TAP
- 5 Free running (Clear LED blinking) - no clock needed! The tempo is set by the length of the initial recording (as with audio loopers)
- 6 USB Midi - display says UB and LENGTH Led lights up

* If you are using an analog clock, you might want to adjust the DIVIDER.

** Beware that there are incompatible versions of the standard MIDI connector (5pin DIN) to 3,5mm (1/8 inch) TRS MIDI jacks adapters on the market. The variants developed during a period before standardisation of the minijack MIDI (around mid 2018). We comply with the standard specified by midi.org.

TIP: TO SEE WHETHER YOUR CLOCK IS ACTIVE, YOU CAN

FURTHER CONNECTIONS

Metronome Out - headphones metronome output.

Reset In - makes the Midilooper go to the first step.

CVs or Pedals - 3 jack inputs which can be either used as CV inputs or as pedal inputs to control the Midilooper interface. The CVs can influence one, two or all voices.

To select if CV is active for a voice hold the voice button for 5 seconds and then use:

QUANTIZE button to activate the RETRIGGER

VELOCITY button to activate VELOCITY CV

TRANSPOSE button to active TRANSPOSE CV

If none of the voices are set to receive CV on that particular jack, the jack will act as a pedal input.

RETRIGGER input will act as RECORD button

VELOCITY input will act as CLEAR button

TRANSPOSE input will cycle thru the voices

TIP: YOU CAN CONNECT ANY SUSTAIN TYPE PEDAL TO CONTROL THE RECORD BUTTON, CLEAR BUTTON OR THE VOICE SELECTION. YOU MIGHT NEED TO USE AN ADAPTER TO MAKE IT 3.5MM ($\frac{1}{8}$ ") INSTEAD OF THE MORE STANDARD 6.3MM ($\frac{1}{4}$ ").THE INPUTS RESPOND TO A CONTACT BETWEEN THE TIP AND THE SLEEVE. YOU CAN ALSO BUILD YOUR OWN PEDAL BY PUTTING ANY BUTTON CONTACT BETWEEN THE TIP AND THE SLEEVE OF THE JACK CONNECTOR. IT ONLY DETECTS TIP-SLEEVE CONTACT.

FURTHER CONNECTIONS

Connect Midilooper to your computer with a USB cable and look for it in your Midi devices. It is a class compliant USB Midi device so it will not need drivers on most computers. Use USB as input for the Midilooper for looping, use it to sync the Midilooper.

Midilooper also mirrors its output to USB so you can play your software synths.

NOTE: MIDILOOPER IS NOT USB HOST YOU CANNOT PLUG IN USB MIDI CONTROLLER INTO THE MIDILOOPER. USB MIDI MEANS THAT MIDILOOPER WILL SHOW UP AS A MIDI DEVICE IN YOUR COMPUTER.

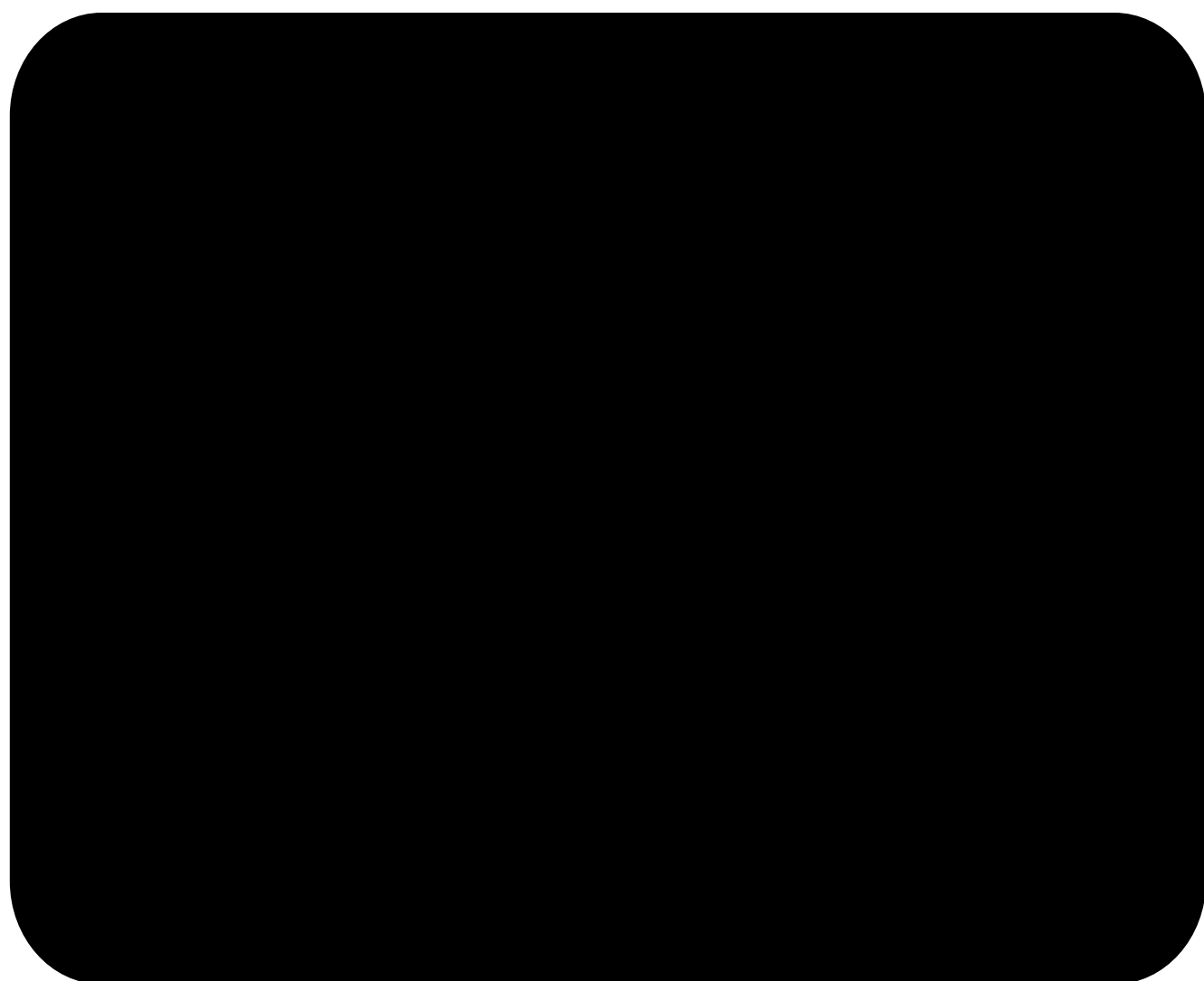
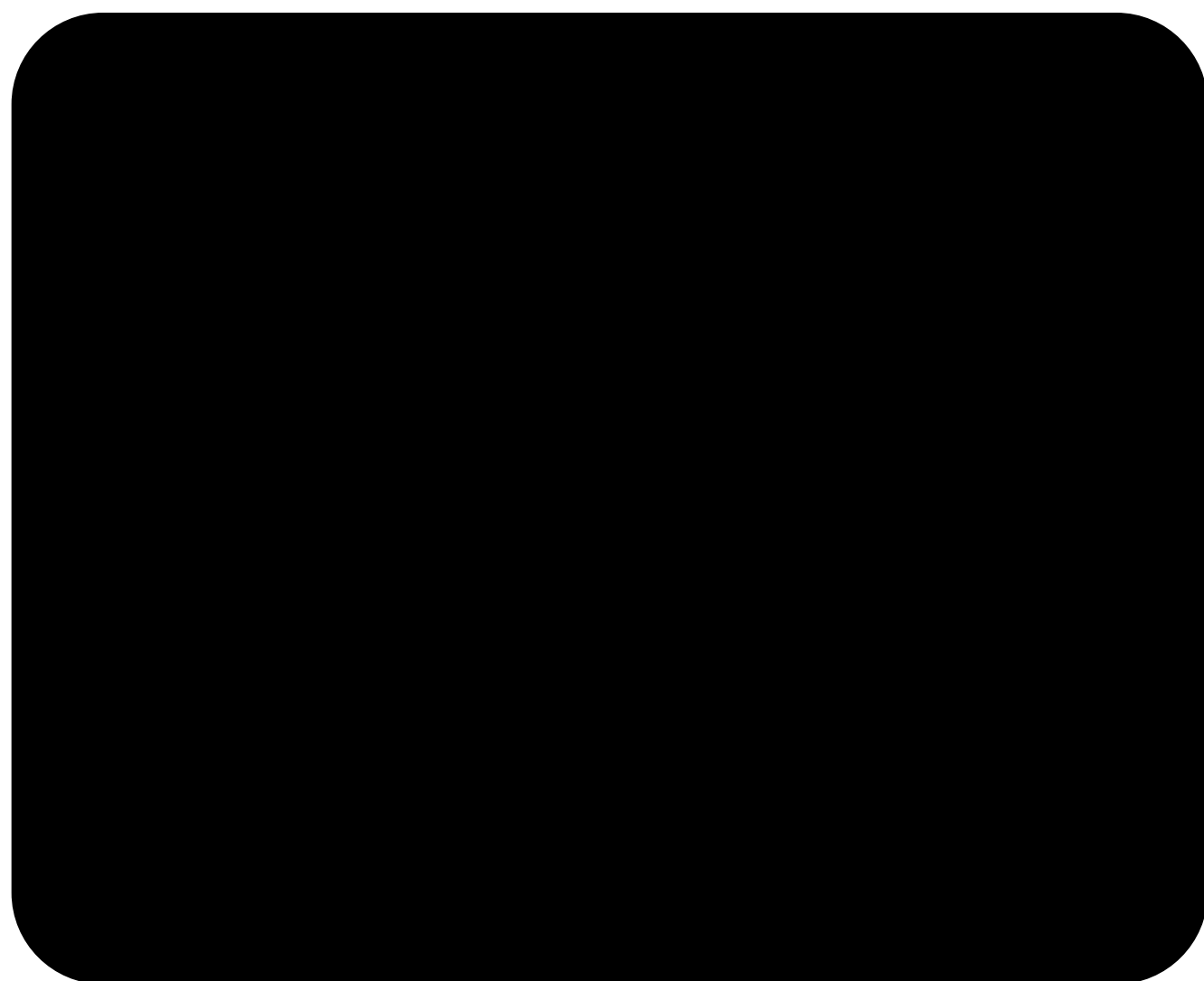

LOOPING

RECORDING INITIAL LOOP

Press the RECORD button to “arm” the recording. The recording will start with the first received MIDI Note or as soon as you press the PLAY/STOP button.

To finish the loop press the RECORD button again at the end of the phrase. Now the LENGTH LED will light up green to indicate you have established a loop length. The length establishes itself automatically for all the voices.

You can change the length for each voice individually, or use the CLEAR function to establish the length by recording (see further).

OVERDUB / OVERWRITE

Once the initial recording has been completed you can either switch the voice and record a loop for a different instrument, or you can add layers to the same voice. Recording with the switch in OVERDUB mode will keep adding new layers. However, in OVERWRITE mode, the initially recorded material will be deleted as soon as at least one note is held and recorded.

ERASE

Use the ERASE button while playback to delete recorded information only while the ERASE button is held down. Works for the selected voice.

CLEARING A LOOP AND MAKING A NEW ONE

To clear a loop of a selected voice press the CLEAR button once. This will delete all the recorded material, while also resetting the loop length. The clearing operation will also “arm” the recording.

Double click the CLEAR button to clear all voices, reset the loop lengths, stop the player and arm the recording. This macro will prepare the Midilooper for a new loop in a single gesture.

LOOPING FLOW CHART

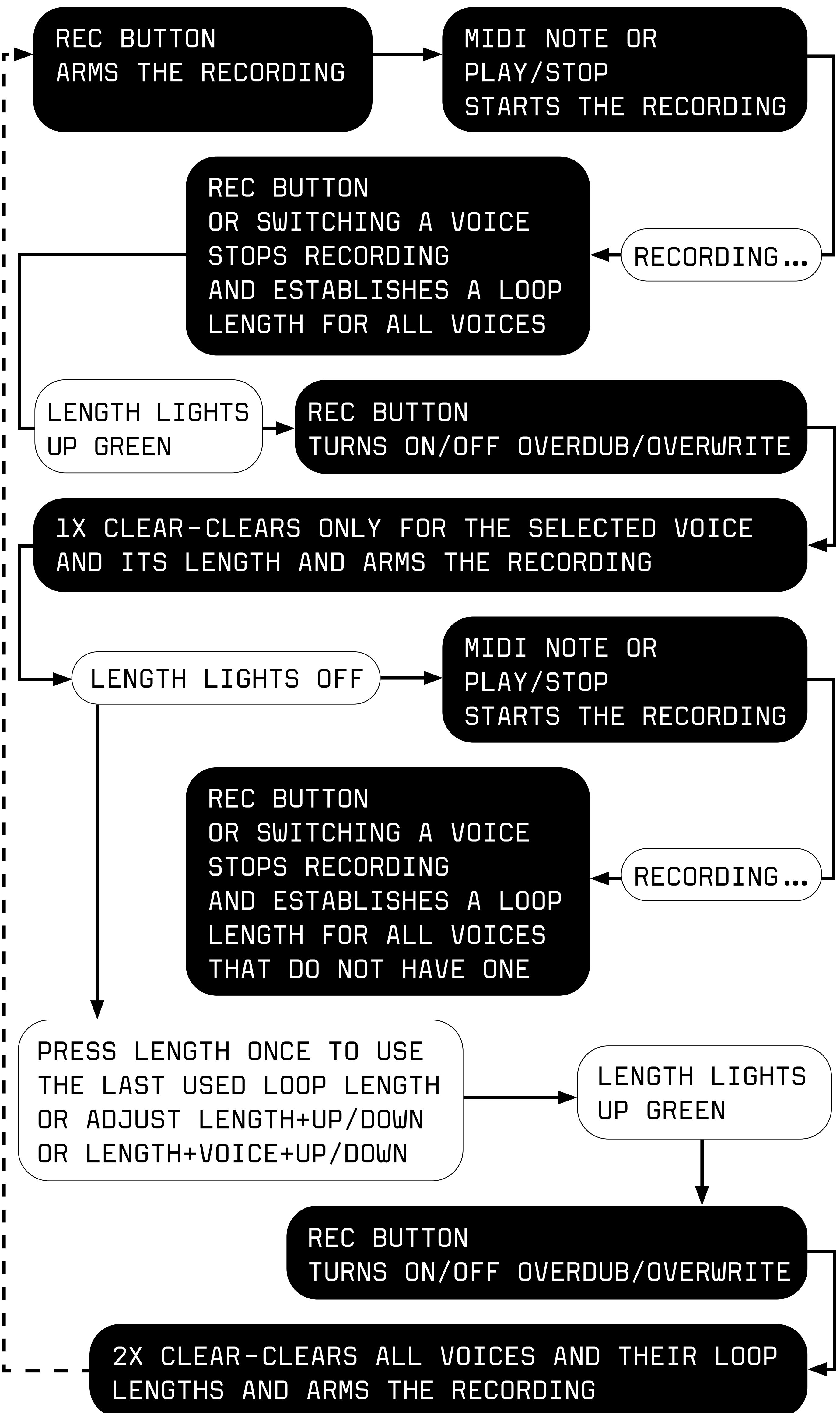

MUTE

Hold the CLEAR button and press the individual voice buttons to MUTE and UNMUTE the voices.

PATTERN SELECTION

The recorded loops for all 3 voices are a pattern. To change between 12 different patterns, hold down the PLAY button and press one of the voice buttons to select one of the three patterns. There are four groups of three patterns and to access a different pattern groups press one of the four smaller buttons (LENGTH, QUANTIZE, VELOCITY, TRANSPOSE) while still holding the PLAY button.

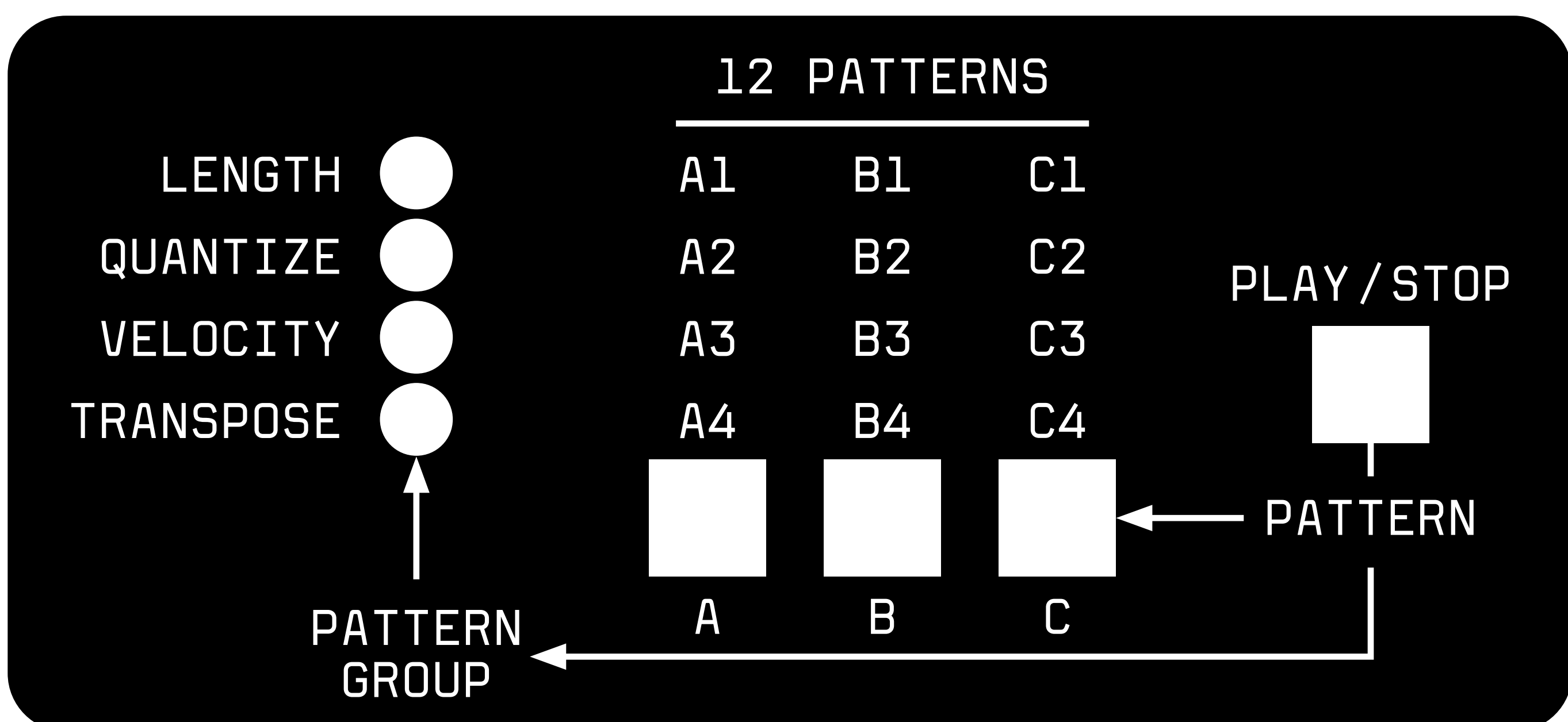

SAVING PATTERNS

To save all patterns press FN+REC. Patterns are stored with these settings: quantize, shuffle, humanize, velocity, length, stretch. All other global settings are saved automatically (Clock selection, MIDI channels etc.)

UNDO

Holding CLEAR and pressing REC toggles between UNdo or REdo. Mistakes might happen and if they do there is one Undo to save you. Undo rolls back the latest action. Be it recording, clearing or erasing. REdo will roll back the latest UNdo so you can also use this feature more creatively. For example to add a new overdub layer remove it and add it again.

MODIFYING THE LOOPS

LENGTH

The LENGTH of your loop can be changed either globally: LENGTH+UP/DOWN or per voice: LENGTH+VOICE+UP/DOWN. The display will show how long the loop is (in beats). Adjusting Length will change in increments of 4 beats 1 bar. To make finer increments TAP and HOLD LENGTH + UP/DOWN to change the Length in increments of +/- 1.

Recording the initial loop will always quantize the loop length to a bar (4 beats). Recorded Loopleght could be longer than 256 beats. Only the display cannot display more numbers than that. Pressing the LENGTH without initial loop established (LENGTH light off) will take the last used Length and set it.

EXAMPLES OF DISPLAYED LOOP LENGTHS

	08.	16.	24.	32.	40.	48.	56.	64.
LENGTH X=	8	16	24	32	40	48	56	64

AND FURTHER DISPLAYED WITH "DOTS" AS:

	08.	16.	24.	32.	40.	48.	56.	64.
64+X=	72	80	88	96	104	112	120	128

	08.	16.	24.	32.	40.	48.	56.	64.
128+X=	136	144	152	160	168	176	184	192

	08.	16.	24.	32.	40.	48.	56.	64.
192+X=	200	208	216	224	232	240	248	256

QUANTIZE

Quantize aligns your recorded material to the grid. Turn it ON or OFF by a single press of the QUANTIZE button.

The amount of QUANTIZE can be changed either globally:

QUANTIZE+UP/DOWN

or per voice: QUANTIZE+VOICE+UP/DOWN.

The number on the display represents the type of grid to which the recorded material will be quantized.

QUANTIZATION OPTIONS

00	NO QUANTISATION (USE IT FOR NO QUANTISATION ON ONE VOICE)
32	QUANTIZES TO 1/32 TH NOTES
16	QUANTIZES TO 1/16 TH NOTES
08	QUANTIZES TO 1/8 TH NOTES
04	QUANTIZES TO QUARTER NOTES
03	QUANTIZES TO TRIPPLETS
06	QUANTIZES TO SEXTUPLETS

VELOCITY

Activating VELOCITY will filter the velocity of all recorded notes and make it a static value.

The value of VELOCITY can be changed either globally:

VELOCITY+UP/DOWN,

or per voice: VELOCITY+VOICE+UP/DOWN.

Tip: If you go with velocity below “00” you will get to “NO” for “normal” or “no-change” of velocity. This way, only certain voices can be affected by VELOCITY.

TRANSPOSE

In Transpose mode, the recorded material can be transposed via live input on your keyboard. The Transpose mode is accessed by pressing the TRANSPOSE button and exited by pressing any of the voice buttons.

To select which voices are affected by the Transpose mode hold down TRANSPOSE and press the voice buttons to activate/deactivate its effect per voice.

Transposition will apply relatively to a root note. To select the root note, hold the TRANSPOSE button and play a MIDI Note via the MIDI Input (DOTS will light up on the display to indicate that the root note has been set).

When the root note has been selected, pressing notes on the keyboard will be transposing recorded material for the selected voices relative to the root note. The last pressed note will stay in effect.

Exiting the Transpose mode will remove the transposition but the root note will be remembered.

NOTE: FOR TRANSPOSE MODE TO TAKE EFFECT AT LEAST ONE OF THE VOICES NEEDS TO BE ACTIVATED AND THE ROOT NOTE HAS TO BE SELECTED.

STRETCH

Stretch can make the recorded loop play at quarter, third, half, double, triple or quadruple speed.

Press: FN+LENGTH+UP/DOWN to change the stretch.

It applies only to the selected voice and it will become active at the moment you release the buttons.

SHUFFLE

Shuffle adds delays to certain 16th notes to achieve a swing effect.

Press: FN+QUANTIZE+UP/DOWN to adjust the amount of Shuffle.

Positive values delay every second 16th note by a set percentage to achieve a swing effect. Negative values add respective amounts of random timing delays to all sent MIDI messages to achieve a more human timing feel.

It applies only to the selected voice and is rendered after the Quantize.

HUMANIZE

Humanize randomly alters the velocity of played MIDI notes.

Perform: FN+VELOCITY+UP/DOWN to set different amounts of Humanize.

The higher the amount, the more the VELOCITY gets randomly affected.

It applies only to the selected voice and is rendered after the Quantize.

OCTAVE

You might also want to add a static octave offset to your voices. Each synth can play in a different octave, or you might want to change this performatively.

Perform: FN+TRANSPOSE+VOICE+UP/DOWN to change the Octave offset per voice.

EXTERNAL CONTROL

RETRIGGER

The Retrigger input will reset envelopes by sending Note Off and Note On in successive order for sustained notes and short Note On and Note Off for the last set of notes played in legato. This will apply to all the notes that have been played in legato even after they are released. “Played in legato” means that as long as you keep overlaying the end of one note with the beginning of another, or until you release all notes, the Midilooper will remember all these notes as played in legato. Simply put, if you play and release a chord and then apply the Retrigger - those notes will be retriggered. The Retrigger can be applied to one, two, or all voices. See [Further Connections](#) on how to assign the CV inputs.

VELOCITY CV

The Velocity CV input adds to the Velocity value of the live-played, recorder or retriggered notes. This can be used in conjunction with the Velocity feature or simply to add accents to certain notes. The Velocity CV can be applied to one, two, or all voices. See [Further Connections](#) on how to assign the CV inputs.

TRANSPOSE CV

The Transpose CV input adds to the Note value of the recorded material. The input is scaled volt per octave. This can be used in conjunction with the Transpose or Octave feature. The Transpose CV can be applied to one, two, or all voices. See [Further Connections](#) on how to assign the CV inputs.

RESET

The Reset input will make the Midilooper go to the first step. It will not play the step, however. Only the clock of the selected clock source will play the first step.

DIVIDER

This option allows you to upscale/downscale your input tempo from the analog clock input. Press FN+ERASE+UP/DOWN to change the divider. The most common clock is every 16th note, however, it could also be faster like 32nd notes or slower like 8th or 4th notes. The display shows the selected number. When “01” is selected, the player will only be advanced per analog clock pulse. Use this option when you work with an irregular clock.

FN+ERASE+UP/DOWN=DIVIDER
SETS SPEED OF ANALOG CLOCK

01 24 PPQN MIDI CLOCK SPEED = 1 PULSE PER STEP
DOES NOT INTERNALLY MULTIPLY THE
CLOCK COULD BE USED WITH DIN SYNC

32 8 PPQN 1 PULSE PER 1/32TH NOTE
SOME MODULAR SYNTHS

16 4 PPQN 1 PULSE PER 1/16TH NOTE
MODULAR SYNTHS

08 2 PPQN 1 PULSE PER 1/8TH NOTE

04 1 PPQN 1 PULSE PER 1/4TH NOTE
TV SHOW AUDIENCE

PPQN = NUMBER OF PULSES PER QUARTER NOTE

NOTE: THE ANALOG CLOCK IS INTERNALLY UPSCALED TO MIDI CLOCK (24 PPQN = PULSES PER QUARTER NOTE) AND SETTING THE DIVIDER WILL FURTHER INFLUENCE THE BEHAVIOUR OF QUANTIZE AND OTHER TIME-BASED SETTINGS.

See [Connect and select your clock source](#) for more information.

PEDAL CONTROL

The user interface can be controlled by foot pedals.
See [Further Connections](#) on how to use external pedals.

LOOPING CCs AND PITCH BEND AND AFTERTOUCH

Control Change and Pitch Bend and Aftertouch (channel) messages can be recorded and looped as well. As with MIDI Notes, the Midilooper will listen to these on all channels and forward them / play them back only on the channels assigned to its voices. The overdub/overwrite mode does not apply to these messages.

Once the first CC of a certain number is received, the Midilooper will remember when it was tweaked, and it will start recording the loop for this CC number. Once it finishes the loop and comes to the same position in the loop as the first CC of that number, it will stop recording the CC and will start the playback of the recorded values.

After that point, any newly arriving CC will act as the first CC and will start the recording until a full loop is reached.

This applies in parallel to all CC numbers (except the special CCs: sustain pedal, all notes off etc.).

TIP: PLAY/STOP+CLEAR = CLEAR ONLY CCS FOR THE SELECTED VOICE.

The logic of Pitch Bend and Aftertouch recording is the same as of the CCs.

FIRMWARE UPDATE

The firmware version is shown on the display in two following frames when you start up the device.

If shown as F1 and then 0.0 read it as Firmware 1.0.0 .

The latest firmware can be found here: <https://bastl-instruments.github.io/midilooper/>

To update the firmware follow this procedure:

- 1 Hold down the Velocity button while connecting the Midilooper to your computer via USB
- 2 The display shows “UP” as for firmware update mode, and MIDILOOPER will show up as an external DISC on your computer (mass storage device)
- 3 Download the latest firmware file (file name midilooper_mass_storage.uf2)
- 4 Copy this file to the MIDILOOPER disc on your computer (Velocity LED will start blinking to confirm success)
- 5 Safely remove (eject) the MIDILOOPER disc from your computer, but do NOT disconnect the USB cable!
- 6 Press the Velocity Button to start the firmware update (the LEDs around the Velocity button will blink, and the device will start up with the new firmware - check the firmware version on the display on startup)

MIDI IMPLEMENTATION CHART

RECEIVES

On all channels:

Note On, Note Off

Pitch Bend

CC (64=sustain)

Channel mode messages:

All Notes Off

MIDI Real Time Messages:

Clock, Start, Stop, Continue

TRANSMITS

On selected channels:

Note On, Note Off

Pitch Bend

CC

MIDI Real Time Messages:

Clock, Start, Stop, Continue

MIDI THRU

MIDI Thru of MIDI Real Time Messages - only when MIDI Clock is selected as a Clock source.

SETUP EXAMPLE 01

NO CLOCK SOURCE - FREE RUNNING MODE
LOOPING MIDI FROM A MIDI CONTROLLER

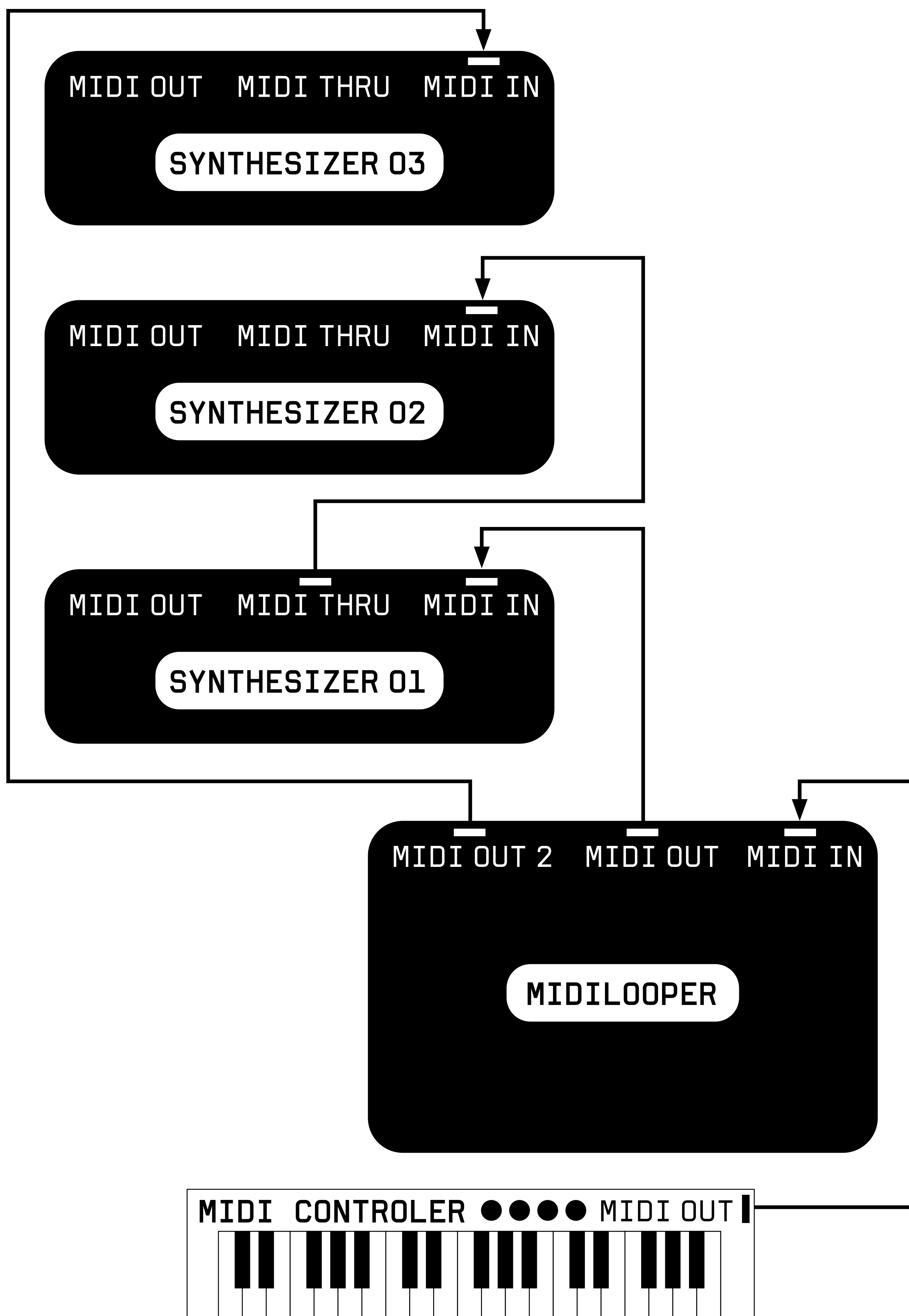

SETUP EXAMPLE 02

SYNCED BY MIDI CLOCK

LOOPING MIDI FROM MORE COMPLEX INSTRUMENT

LISTENING TO METRONOME ON HEADPHONES

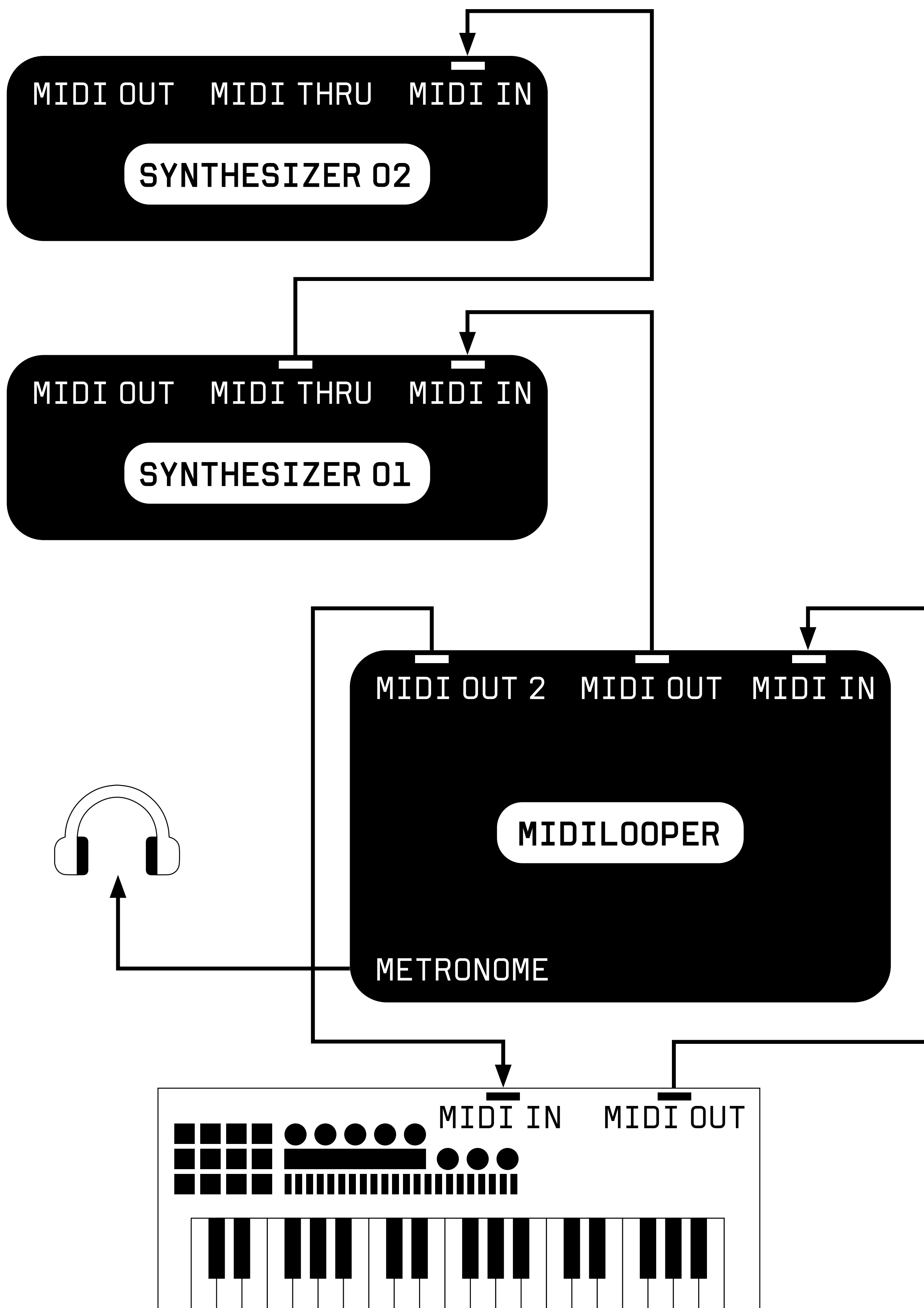

SETUP EXAMPLE 03

SYNCED TO DRUM MACHINE VIA MIDI CLOCK (VIA TRS JACK)
LOOPING MIDI FROM A MIDICONTROLLER
CONTROLLING LOOPER WITH FOOTPEDALS

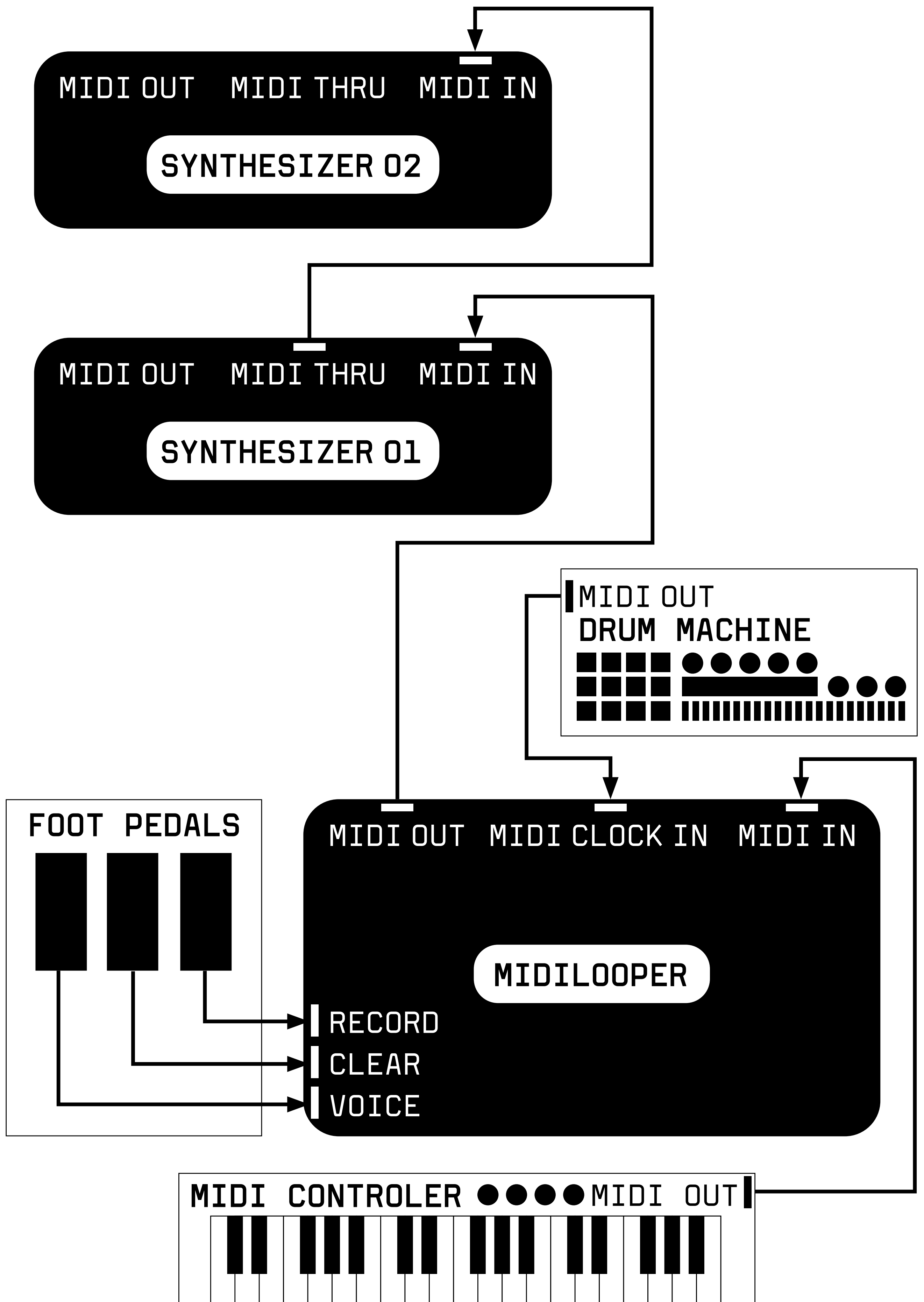

SETUP EXAMPLE 04

SYNCED TO ANALOG CLOCK FROM MODULAR SYNTHESIZER
LOOPING MIDI FROM A KEYBOARD SYNTH
CONTROLLED BY CVS AND TRIGGERS FROM A MODULAR SYNTH

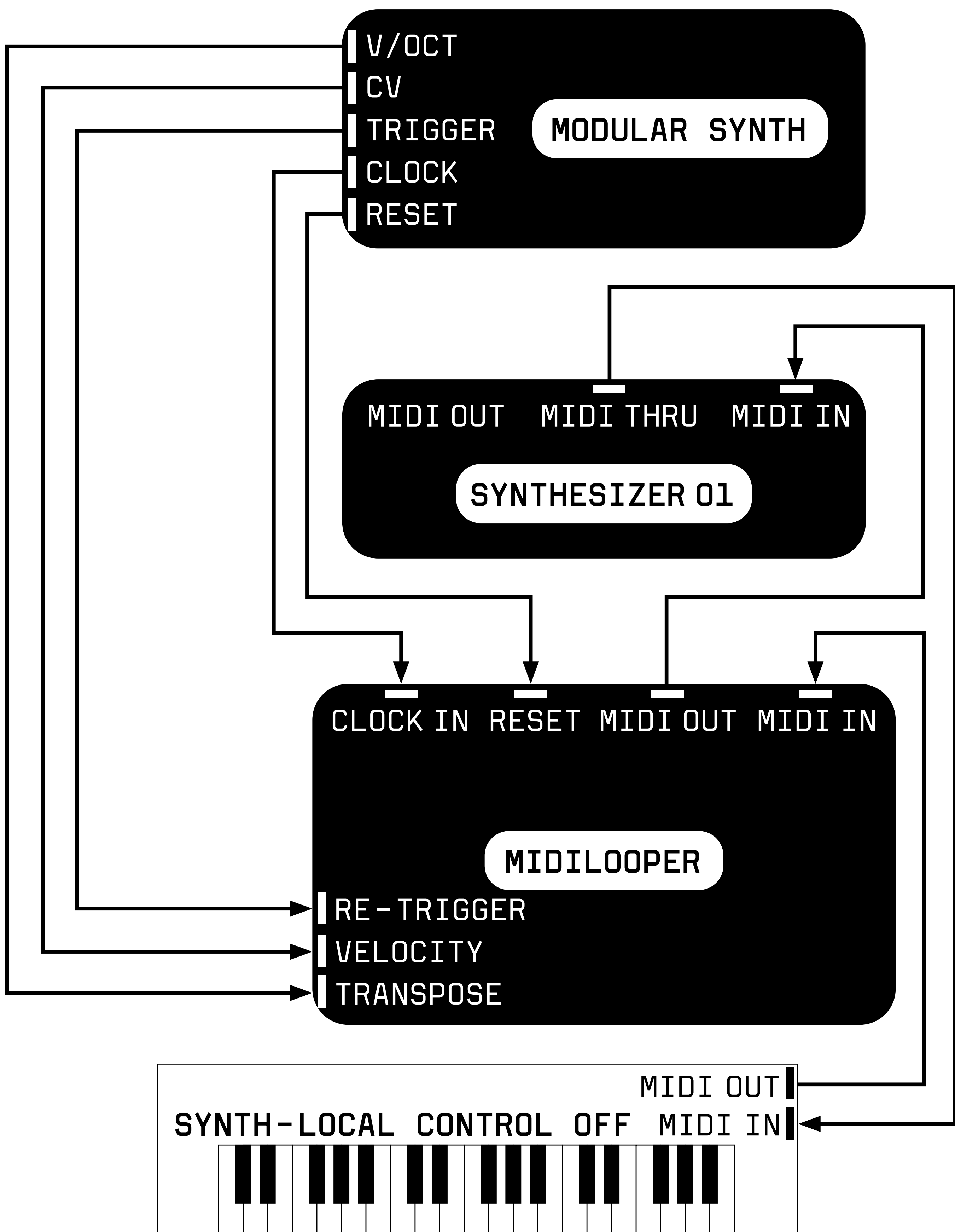

SETUP EXAMPLE 05

SYNCED BY USB MIDI CLOCK

LOOPING MIDI FROM LAPTOP

LISTENING TO METRONOME ON HEADPHONES

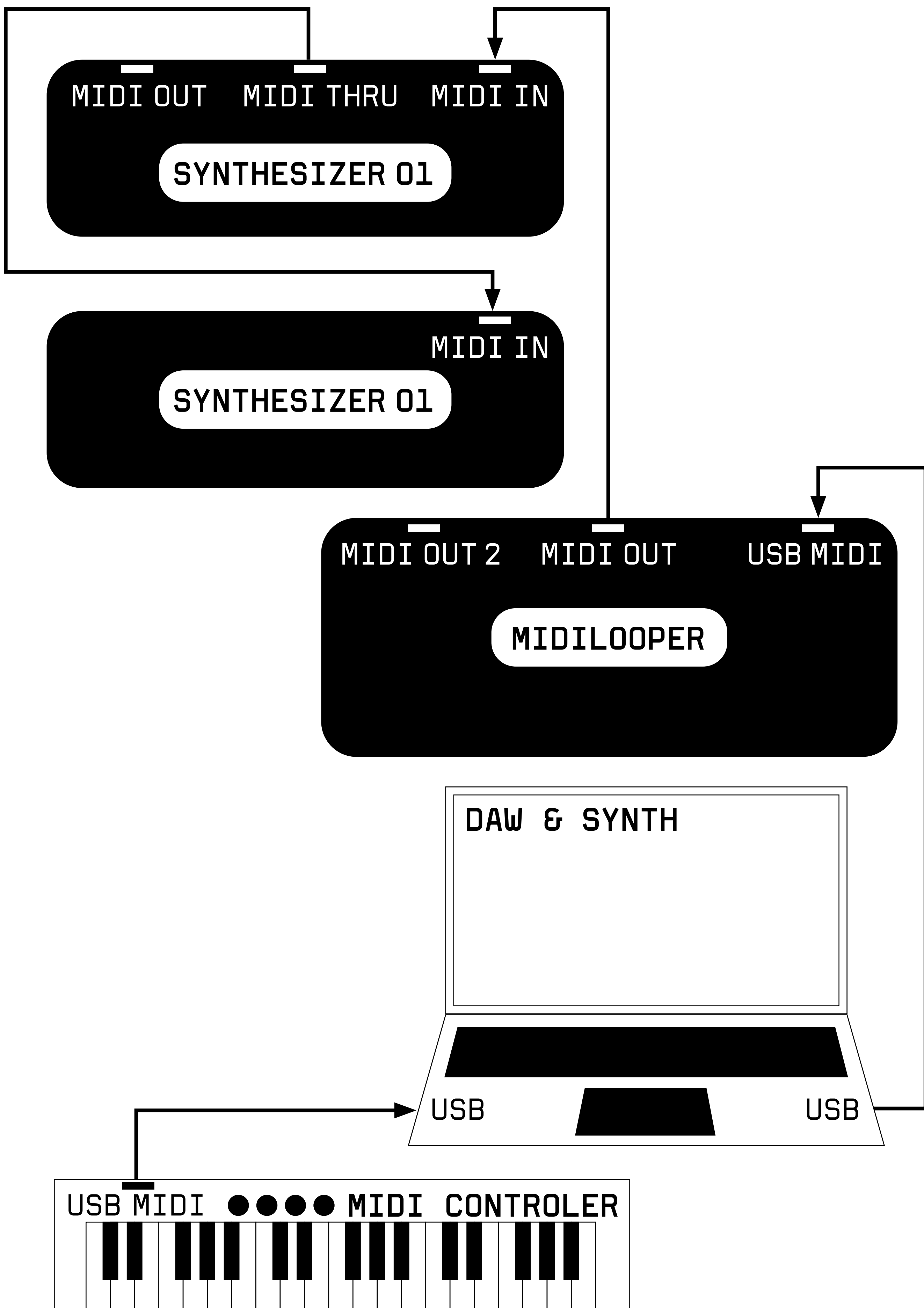

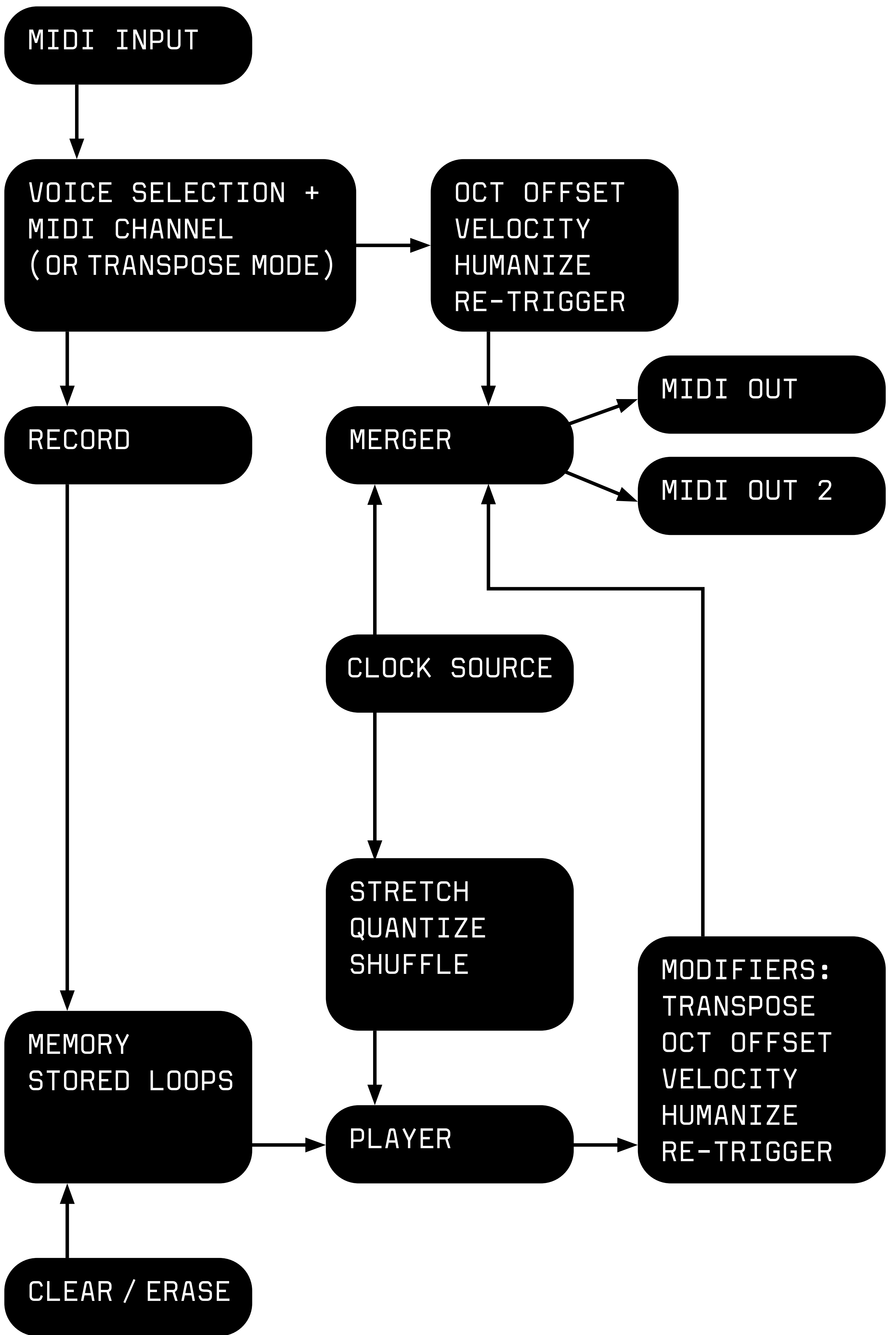

**Go to www.bastl-instruments.com
for more info and video tutorials.**