

User's Guide



Babyface Pro *FS*

Crafted with Passion

24 Bit / 192 kHz ✓

TotalMix™



SteadyClock FS™



SyncCheck™

USB 2.0 Digital I/O System
24 Channels Analog / ADAT / SPDIF Interface
24 Bit / 192 kHz Digital Audio
24 x 12 Matrix Router
MIDI I/O
MIDI Remote Control
Stand-Alone Operation
Class Compliant Operation

Safety Instructions and Proper use



Read the manual carefully and completely before using the device. Pay attention to the following information on how to use and operate the Babyface Pro safely. Improper use can lead to loss of warranty claims (see warranty statement on page 96).

Proper Use

The Babyface Pro is a digital audio interface for professional audio applications for use with CE approved class B computers with USB slot.



To comply with the European CE standard, the Babyface Pro must be used with a CE approved Class B computer. All connecting cables must be shielded. The computer and all cables connected to the Babyface Pro must be properly grounded. Operation with non-certified computers and cables may cause interference to other devices as well as the Babyface Pro.

Safety Instructions

The Babyface Pro has no user-serviceable parts. Repair work must only be carried out by qualified personnel.

The Babyface Pro must not come into contact with water or humidity. Extreme temperatures must be avoided.

Changes or modifications of the Babyface Pro not approved by RME may void the warranty and guarantee.



Unauthorized servicing/repair voids warranty. Only use accessories specified by the manufacturer.



► **General**

1	Introduction	8
2	Package Contents	8
3	System Requirements	8
4	Brief Description and Characteristics	8
5	First Usage - Quick Start	
5.1	Connectors – Controls – Display.....	9
5.2	Quick Start.....	11
5.3	Operation at the Unit	11

► **Installation and Operation - Windows**

6	Hardware Installation	14
7	Driver and Firmware	
7.1	Driver Installation	14
7.2	De-installing the Drivers	15
7.3	Firmware Update.....	15
8	Configuring the Babyface Pro	
8.1	Settings Dialog – General	16
8.2	Settings Dialog – Pitch	18
9	Operation and Usage	
9.1	Playback.....	19
9.2	DVD Playback (AC-3 / DTS)	19
9.3	Notes on WDM.....	20
9.4	Channel Count under WDM.....	21
9.5	Multi-client Operation	21
9.6	Analog Recording.....	22
9.7	Digital Recording.....	22
9.8	Digital Connections	23
9.9	Clock Modes - Synchronization.....	24
10	Operation under ASIO	
10.1	General.....	25
10.2	Channel Count under ASIO.....	25
10.3	Known Problems	26
11	Using more than one Babyface Pro	26
12	DIGICheck Windows	27
13	Hotline – Troubleshooting	28

► **Installation and Operation - Mac OS X**

14	Hardware Installation	30
15	Driver and Firmware	
15.1	Driver Installation.....	30
15.2	De-installing the Drivers	31
15.3	Firmware Update.....	31
16	Configuring the Babyface Pro	
16.1	Settings Dialog – General	32
16.2	Clock Modes - Synchronization.....	33
17	Mac OS X FAQ	
17.1	MIDI doesn't work.....	34
17.2	Repairing Disk Permissions	34
17.3	Supported Sample Rates	34
17.4	Channel Count under Core Audio	34
17.5	Various Information	35

18	Using more than one Babyface Pro	35
19	DIGICheck Mac	36
20	Hotline – Troubleshooting	37

▶ TotalMix FX

21	Routing and Monitoring	
21.1	Overview	40
21.2	The User Interface	42
21.3	The Channels.....	43
	Settings.....	45
	Equalizer.....	46
21.4	Section Control Room.....	48
21.5	The Control Strip	49
	21.5.1 View Options	50
	21.5.2 Snapshots - Groups	51
	21.5.3 Channel Layout – Layout Presets	52
	21.5.4 Scroll Location Markers.....	53
21.6	Reverb and Echo	54
21.7	Preferences.....	57
	21.7.1 Store for Current User or all Users	58
21.8	Settings	59
	21.8.1 Mixer Page	59
	21.8.2 MIDI Page	60
	21.8.3 OSC Page	61
	21.8.4 Aux Devices	62
21.9	Hotkeys and Usage.....	63
21.10	Menu Options.....	64
21.11	Menu Window	65
22	The Matrix	
22.1	Overview	65
22.2	Elements of the Matrix View	65
22.3	Operation	66
23	Tips and Tricks	
23.1	ASIO Direct Monitoring (Windows)	66
23.2	Copy a Submix.....	66
23.3	Doubling the Output Signal (Mirror)	66
23.4	Delete a Submix.....	66
23.5	Copy and Paste everywhere	67
23.6	Recording a Submix - Loopback.....	67
23.7	MS Processing.....	68
23.8	Program start options (Windows)	68
24	MIDI Remote Control	
24.1	Overview	69
24.2	Mapping	69
24.3	Setup.....	70
24.4	Operation	70
24.5	MIDI Control.....	71
24.6	Loopback Detection	72
24.7	OSC (Open Sound Control)	72
25	DAW Mode	73
26	TotalMix Remote	74

► **Technical Reference**

27 Technical Specifications

27.1	Analog	78
27.2	MIDI	79
27.3	Digital	79
27.4	Digital Inputs	79
27.5	Digital Outputs	79
27.6	General	80

28 Technical Background

28.1	Lock and SyncCheck	80
28.2	Latency and Monitoring	81
28.3	USB Audio	82
28.4	DS – Double Speed	83
28.5	QS – Quad Speed	83
28.6	Noise Level in DS / QS Mode	84
28.7	SteadyClock	84

29 Diagrams

29.1	Block Diagram Babyface Pro FS	85
29.2	Connector Pinouts	86

► **Stand-Alone and Class Compliant Modes**

30	General	88
31	System Requirements for iPad Operation	88
32	Operation	88
32.1	Useful Hints	89
32.2	Class Compliant under Windows/Mac OS X	89
33	Supported Inputs and Outputs	
33.1	Class Compliant Mode	90
33.2	Stand-Alone Mode	90
34	Operation at the Unit	91
35	Application Examples Stand-Alone Mode	93
36	Useful Notes	93

► **Miscellaneous**

37	Accessories	96
38	Warranty	96
39	Appendix	97
40	Declaration of Conformity	98

User's Guide



Babyface Pro *FS*

► General

1. Introduction

Thank you for choosing RME's Babyface Pro FS. This unique portable desktop audio interface is capable of transferring analog and digital audio data directly to Windows and Mac computers. The latest Plug and Play technology guarantees a simple installation, even for the inexperienced user. Numerous unique features put the Babyface Pro FS at the very top of the range of computer-based audio interfaces.

The Babyface Pro has drivers for Windows 7 / 8 / 10 and Mac OS X x86 (Intel).

Our high-performance philosophy guarantees maximum system performance by executing as many functions as possible not in the driver (i.e. the CPU), but within the audio hardware.

2. Package Contents

- Babyface Pro FS
- Cable USB 2.0 A plug to right angle B plug, length 39" (1m)
- Cable USB 2.0 C plug to right angle B plug, length 39" (1m)
- MIDI breakout cable
- Carrying box
- Manual

3. System Requirements

- Windows 7 or up, Intel Mac OS X (10.6 or up)
- 1 USB 2.0 port or USB 3 port
- Computer with at least Pentium Core 2 Duo CPU

4. Brief Description and Characteristics

- Housing machined from a block of aluminium
- Intuitive and efficient user interface
- Mic stand thread on the bottom for free positioning
- All settings can be changed in real-time
- Buffer sizes/latencies from 48 up to 8192 samples selectable
- 4 channels 96 kHz/24 bit Record/Playback via ADAT optical (S/MUX)
- Clock modes slave and master
- Automatic and intelligent master/slave clock control
- Unsurpassed Bitclock PLL (audio synchronization) in ADAT mode
- SteadyClock FS: Jitter-immune, super-stable digital clock
- DDS technology for free setting of the sample rate
- SyncAlign guarantees sample aligned and never swapping channels
- SyncCheck tests and reports the synchronization status of input signals
- TotalMix for latency-free submixes and perfect ASIO Direct Monitoring
- TotalMix: 288 channel mixer with 46 bit internal resolution
- TotalMix FX: 3-band EQ, Low Cut, Reverb, Echo
- 1 x MIDI I/O, 16 channels high-speed MIDI
- 2 digitally controlled microphone inputs in reference quality
- 2 balanced line outputs, level +19 dBu
- 1 x headphone output with separate driver stages for high and low impedance phones
- DIGICheck DSP: Level meter in hardware, peak- and RMS calculation

5. First Usage – Quick Start

5.1 Connectors – Controls – Display

The top of the Babyface Pro features a hi-precision rotary encoder, 6 buttons, 4 LED bands and 6 status LEDs.

The four **LED bands** show the current gain, the input and output level, and the channel to be set, all dependent on the current mode. The lowest LEDs signal phantom power (+48 V, orange) and DIM, the highest one overload (clip, red).

The **rotary encoder** is used to change various parameters directly at the unit. The 4 buttons IN, A (SET), (MIX) B and OUT directly access the respective function.

IN gives access to Gain control and phantom power. Press IN several times to step through the inputs 1/2, 3/4 and Optical (SPDIF/ADAT). Press SELECT several times to step through left, right or both channels, as indicated by flashing LEDs. Then turn the wheel to change the gain, or press SET to activate phantom power (only in stand-alone mode). Phantom power is signalled by two orange LEDs at the bottom of meters 1 and 2.

OUT gives access to the output volume control. Press OUT several times to step through the outputs 1/2, Phones and Optical (SPDIF/ADAT). Then turn the wheel to change the level. To change the output balance press and hold SELECT before turning the wheel.

DIM activates Dim for the Main Out as defined in TotalMix FX.

The input LED **Opt** also serves as synchronisation indicator for the digital input. It stays yellow when the input is selected but has no input signal (No Lock). It flashes green when the signal has been detected but is not fully synchronous (Lock). When in Sync, the color changes to a constant green. See also chapter 9.9 / 16.2, Clock Modes - Synchronisation.

The button **DIM** is also used for **Recall**, to load a specific listening volume for the Main Out that can be defined in TotalMix FX. Pushing the knob SET for 2 seconds when OUT is selected stores the current setting. If the volume (output level) had been changed pressing DIM for two seconds will restore the former value.

On the underside of the Babyface Pro FS there is a 3/8" thread for mounting the unit on tripods, as well as a recessed slide switch that sets the **maximum XLR output level to +19 dBu (default) or +4 dBu**. +4 dBu is recommended when connecting sensitive amplifiers or active monitors. It helps to reduce noise and to less lower the fader in TotalMix FX because the output level is then 15 dB lower.



The right side of the Babyface Pro has two instrument/line inputs, two headphone outputs, and a K-slot for theft protection locks/cables.

The analog inputs 3/4 are high impedance, unbalanced multi-purpose inputs with TS jacks. They include 9 dB fine digital gain control, and a choice of +4 dBu or -10 dBV reference level, controlled from the Tools menu of input channels 3 and 4 in TotalMix FX.



The output channels 3/4 feed two **Phones** outputs via two independent driver circuits, optimized for high (TRS 1/4", 6.35mm) and low impedance (TRS 1/8", 3.5mm) headphones. Their unbalanced output signal is – in terms of quality – identical to the ones at the XLR line outputs, but lower in level.

In case the phones output is to be used as line output an adapter TRS plug to RCA phono plugs, or TRS plug to two TS plugs is required. More on cable codes and pinouts can be found in chapter 29.2.

The back of the unit has the XLR inputs and outputs of channels 1/2 (setting the maximum output level is described on page 7)..

! *The short circuit protected, low impedance **XLR line outputs** do not operate servo balanced! When connecting unbalanced equipment, make sure pin 3 of the XLR output is not connected. A connection to ground might cause a decreased THD (higher distortion) and increased power consumption!*

The Babyface Pro has two analog **microphone** inputs that can operate as **line** inputs with levels up to +19 dBu, when set to 0 dB gain and PAD active. The electronic input stage uses a servo balanced design which handles unbalanced and balanced signals correctly, automatically adjusting the level reference.

! *When using unbalanced cables with the **XLR inputs** pin 3 of the XLR jack should be connected to ground. Otherwise noise may occur, caused by the unconnected negative input of the balanced input.*



The left side of the Babyface Pro has an optical input and output, a power supply connector, a USB socket and a 6-pin MINI DIN connector for the included MIDI breakout cable.

Optical I/O (TOSLINK): The unit automatically detects SPDIF or ADAT input signals. The optical output can operate as ADAT or SPDIF output, depending on the current setting in the Settings dialog.

USB 2.0: Standard USB socket for connection to the computer. Please make sure the Babyface Pro can have the full voltage/current delivered from the computer by using hi-quality USB cables (like the one included), no USB extension cables and no USB hubs. When connected to USB 3 only the USB 2 protocol will be used.

Socket for power connection. Unburdens the computer's power supply, or ensures a stable power supply, in case it proves to be insufficient when taken from the computer. This socket supports locking type jacks as found on the optional RME DC power supply. After inserting the connector carefully turn it by 90° so that it locks.

5.2 Quick Start

After the driver installation (chapter 7 / 15), connect the inputs to the analog signal source.

The analog input sensitivity can be changed at the unit (IN, SELECT) or in TotalMix FX (Tools, Gain). To achieve the best signal to noise ratio, adjust your analog source to its highest output level and then decrease the input gain in TotalMix or at the Babyface itself to make sure that the loudest signal reaches about -3dBFS.

The XLR line inputs of the Babyface Pro can be used with +4 dBu and -10 dBV line signals. The electronic input stage can handle balanced (XLR, TRS jacks) and unbalanced (TS jacks) input signals correctly.

On the analog playback side (the DA side), an adjustment of the analog output level is available by the rotary encoder (select desired output via OUT), or in TotalMix FX.

The output signal of channels 3/4, Phones, can be set freely using the rotary encoder. These outputs are optimized for headphones, but can also be used as line outputs.

The Babyface Pro digital inputs and output support the formats SPDIF and ADAT optical.

TotalMix FX remembers all settings, and loads these automatically when the Babyface Pro drivers are loaded.

5.3. Operation at the Unit

Operation at the unit in online mode (drivers installed under Windows and Mac OS X, PC mode chosen at the unit) covers the most useful actions and situations in daily operation. Clearly labelled buttons together with an intuitive operation scheme give direct access to volume, monitoring and setup.

Input Gains

The gains of all four analog inputs can be controlled directly by the big encoder knob. Use IN to select input 1/2 or 3/4, then push SELECT several times to step through left channel, right channel or both. The selected channel and amount of gain is shown by a single LED flashing in the left INPUT level meters. Turn the wheel to increase or decrease the gain. The three INPUT LEDs also show overload. Too hot levels will not be missed even if the level meter currently shows a quieter channel.

Output Volume

Select one of the three outputs via OUT, then turn the wheel. The current fader position of TotalMix FX (which moves in sync) is displayed via flashing single LEDs in the output level meter. The three output LEDs also show overload. Too hot levels will not be missed even if the level meter currently shows a quieter channel.

0 dB position: reduce the gain so that the yellow LED just turns off.

OUT can also be reassigned to perform Speaker B switching in the Options/Key Commands dialog in TotalMix FX.

Output Balance

Select one of the three outputs via OUT, then hold down SELECT. The right level meters show two bars, lit up until the yellow LEDs. Turn the wheel to move the stereo image more to the left or right. This setting equals an adjustment of the PAN knob in a stereo hardware output of TotalMix FX, and indeed the knob in the software will move in sync.

DIM

Works on the hardware output defined as Main Output in TotalMix FX. Therefore the DIM LEDs will not be lit when stepping through the other two outputs. The applied attenuation is the one defined in TotalMix FX. DIM can also be used as hotkey for many other actions, among the switching to Speaker B or Talkback. Use the Options/Key Commands dialog in TotalMix FX to assign one of them to DIM.

Recall

Pushing DIM for two seconds sets the Main output volume to the value formerly saved for Recall. The Recall value can also be set directly at the unit by holding SET down for two seconds.

Monitoring – MIX

Additionally to the extensive routing and mixing options in TotalMix FX, which provide perfect monitoring solutions, the monitoring level of all three input sources to all three output destinations can be controlled directly at the unit. No need to grab the mouse and bring TM FX into the foreground! Operation is easy and logical:

- Use **OUT** to select the output for the monitoring, i.e. where the signal will be routed to
- Use **IN** to select the input with the signal that should be monitored
- Push **MIX**. The input level LEDs start to flash
- Use **SELECT** to choose between left, right or both channels
- Turn the encoder to set the actual monitoring level

While the setup is simplified (no panorama available) it is still very efficient and will address most needs. Note that direct control covers only channels 1/2 from ADAT.

TotalMix FX in Submix view (default) will highlight the currently selected submix and move the corresponding input fader in sync with the Babyface Pro, so that the ongoing process can be controlled and followed easily at the screen. This helps in setup and understanding of the monitoring function.

Switch digital output format (SPDIF <> ADAT)

Use OUT to select the optical output (Opt.). Push SET. The level meter will signal ADAT mode with 8 LEDs, SPDIF mode with 2 LEDs turned on. Use SELECT to switch between them. This setting is also available in the driver's Settings dialog.

In stand-alone mode with the input Opt currently active the left level meters will show the status of the incoming optical signal in the same way, on the left level meters.

Hotkeys A (SET) and B (MIX)

In online mode SET and MIX have only one function each (setting the Recall volume and starting the direct monitoring control). Both functions are also available in TotalMix FX at the computer, but both buttons can be reconfigured (like DIM) to perform many other functions, like Talkback, global mute, Mono, External Input, changing Snapshots and Channel Layouts and more. Just select the function that suits your personal workflow best.

LED Brightness

Default brightness is 25%. The LEDs can be changed to 50% and 100% brightness, where 100% obviously will cause a higher power consumption. This might be useful in daylight conditions. The difference between 25% and 100% is 0.5 Watts or 100 mA higher load at 5V bus power with all LEDs lit. To step through the three brightness states hold down SELECT and push IN several times.

User's Guide



Babyface Pro *FS*

► Installation and Operation – Windows

6. Hardware Installation

To simplify installation it is recommended to first install the drivers before the unit is connected to the computer. But it will also work the other way round.

In case the level meters of the Babyface Pro show **CC** during power-on: the unit is in **Class Compliance** mode and will **not** work under Windows. Remove the USB cable, hold SELECT and DIM button down, plug-in the USB cable or the power supply. This procedure changes between CC and normal mode. When the LED Level meters change to **PC** the normal mode is active.

When using a power supply (stand-alone mode), holding down SELECT and DIM for more than two seconds repeatedly changes between PC and CC. Note that changing the operating mode is not supported during normal USB operation, so any USB connection has to be removed.

Chapter 28.3 explains how to find the ideal USB port.

7. Driver and Firmware

7.1 Driver Installation

RME is constantly updating their drivers, and modern computers mostly do not have a CD drive anymore. Therefore please download the drivers from the RME website at <http://rme.to/downloads>. Unzip the downloaded file and start the driver installation with *rmein-staller.exe*.

Start *rmein-staller.exe* and follow the instructions of the installer. After installation connect computer and Babyface Pro. Windows detects the new hardware as **Babyface Pro** and installs the drivers automatically.

After a reboot, the icons of TotalMix FX and Settings dialog appear in the notification area. Windows might hide them behind the triangle, click on it to access them and to configure their appearance.

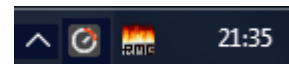

Driver Updates do not require to remove the existing drivers. Simply install the new driver over the existing one.

Possible reasons why a Babyface Pro is not found automatically:

- The Babyface Pro is in Class Compliant mode. See above.
- The USB port is not active in the system (check the Device Manager)
- The USB cable is not, or not correctly inserted into the socket
- The Babyface Pro does not receive any or not enough power. Remove current-consuming hard drives from nearby ports. Avoid USB extension cables and USB hubs. Use an external power supply, any standard one delivering 9 - 14 V DC with at least 1 A will work. The connector needs to have – outside, + inside.

7.2 De-installing the Drivers

A de-installation of the driver files is not necessary. Thanks to full Plug & Play support, the driver files will not be loaded after the hardware has been removed.

Unfortunately Windows Plug & Play methods do not cover the additional autorun entries of TotalMix, the Settings dialog, and the registration of the ASIO driver. These entries can be removed from the registry by a software de-installation request. This request can be found (like all de-installation entries) in *Control Panel, Programs and Features (XP: Add or Remove Programs)*. Click on the entry 'RME Fireface USB'. Here it is also possible to remove the driver itself. Select *Windows Driver Package – RME Fireface USB*, then *Uninstall*.

7.3 Firmware Update

The Flash Update Tool updates the firmware of the Babyface Pro to the latest version. It requires an already installed driver. Please download the FUT from the RME website at <http://rme.to/downloads>.

Unzip the downloaded file and start the firmware update with **fut_usb.exe**. The Flash Update Tool displays the current revision of the Babyface Pro's firmware, and whether it needs an update or not. If so, then simply press the 'Update' button. A progress bar will indicate when the flash process is finished (Verify Ok).

After the update the Babyface Pro needs to be reset. This is done by powering down the Babyface Pro for 5 seconds. A reboot of the computer is not necessary.

When the update unexpectedly fails (status: failure), the unit's Safety BIOS will be used from the next boot on, the unit stays fully functional. The flash process should then be tried again.

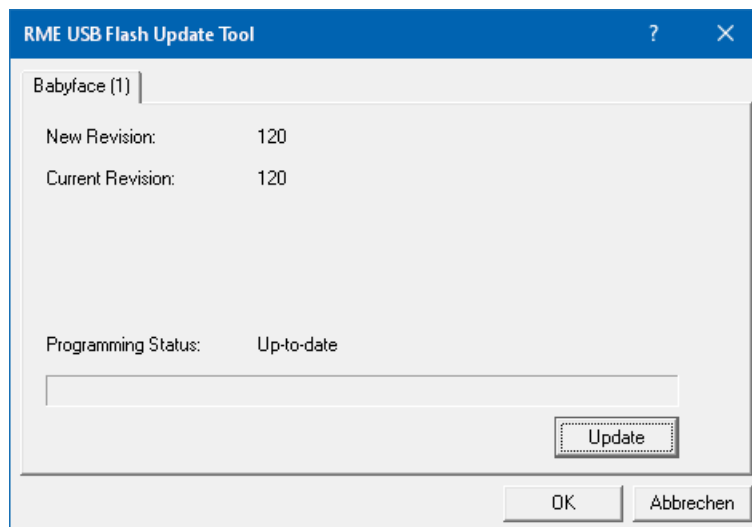

8. Configuring the Babyface Pro

8.1 Settings Dialog - General

Configuration of the Babyface Pro is done via its own settings dialog. The panel 'Settings' can be opened:

- by clicking on the fire symbol in the Task Bar's notification area

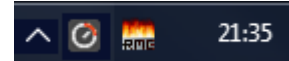

The mixer of the Babyface Pro (TotalMix FX) can be opened:

- by clicking on the FX symbol in the Task Bar's notification area

The hardware of the Babyface Pro offers a number of helpful, well thought-out practical functions and options which affect how the card operates. The following is available in the Settings dialog:

- Latency
- Configuration of the digital I/O
- Current sample rate
- Synchronization behaviour
- State of input and output

Any changes made in the Settings dialog are applied immediately - confirmation (e.g. by clicking on OK or exiting the dialog) is not required.

However, settings should not be changed during playback or record if it can be avoided, as this can cause unwanted noises.

Also, please note that even in 'Stop' mode, several programs keep the recording and playback devices active, which means that any new settings might not be applied immediately.

The tab **About** includes information about the current driver and firmware version plus three more options:

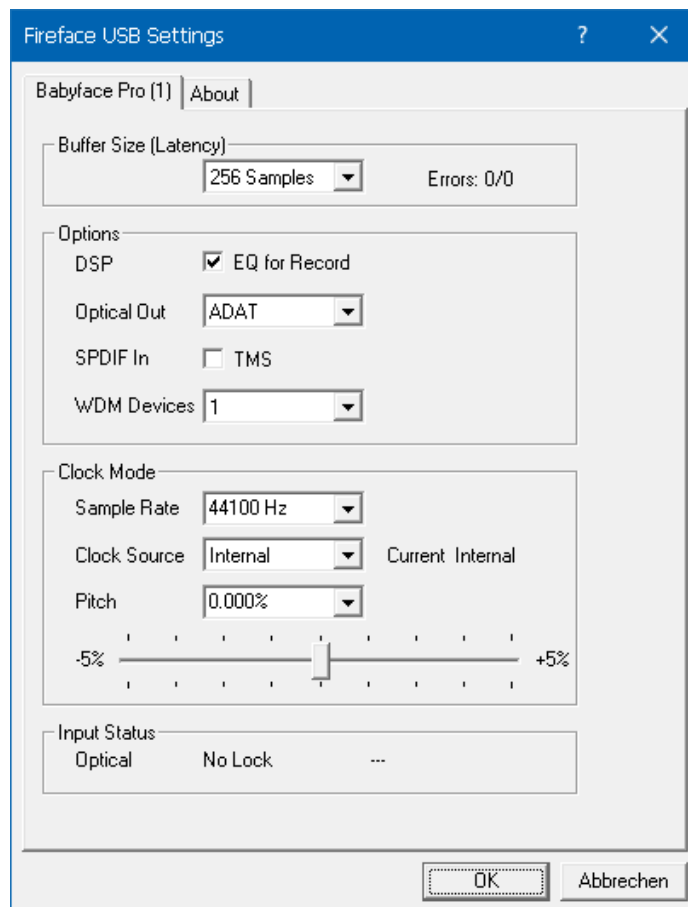

Lock Registry

Default: off. Checking this option brings up a dialog to enter a password. Changes in the Settings dialog are no longer written to the registry. As the settings are always loaded from the registry when starting the computer, this method provides an easy way to define an initial state for the Babyface Pro.

Enable MMCSS for ASIO activates support with higher priority for the ASIO driver. Note: At this time, activating this option seems to be useful only with the latest Cubase/Nuendo at higher load. With other software this option can decrease performance. The change becomes active after an ASIO reset. Therefore it is easy to quickly check which setting works better.

Sort ASIO Devices

Changes the order only of the ASIO channels when using more than one interface.

Buffer Size

The setting *Buffer Size* determines the latency between incoming and outgoing ASIO and WDM data, as well as affecting system stability (see chapter 9.1 / 10).

Errors does not refer to buffer errors, but USB transmission errors. The display will be reset on any start of a playback/record. More information can be found in chapter 28.3.

Options

DSP – EQ for Record

Switches the 3-band EQ and Low Cut of all input channels into the recording path. In case Loopback has been activated the EQ and Low Cut of the Output channel is also placed into the recording path. See also chapter 23.6.

Optical Out

The optical TOSLINK output can operate as ADAT or SPDIF output. The Channel Status is fixed to Consumer state.

Note: The optical input detects the incoming format automatically.

SPDIF In

TMS activates the transmission of Channel Status data and Track Marker information from the SPDIF input signal to a software that supports receiving it. If not needed this option should be turned off.

WDM Devices

Reduce the number of WDM devices to the ones really needed to improve performance of the operating system.

Clock Mode

Sample Rate

Sets the currently used sample rate. Offers a central and comfortable way of configuring the sample rate of all WDM devices to the same value, as since Vista the audio software is no longer allowed to set the sample rate. However, an ASIO program can still set the sample rate by itself.

During record/playback the selection is greyed out, so no change is possible.

Clock Source

The unit can be configured to use its own clock (Internal = Master) or the digital input signal (Optical = Slave). If the external source isn't available (Input Status No Lock), the unit will change to the internal clock. The current clock source is displayed as *Current*.

Pitch

More information on Pitch is available in chapter 8.2.

Input Status

Indicates presence of a valid signal at the optical input (Lock, No Lock) and whether the signal is synchronous (Sync). The third column shows the sample frequency detected by the hardware (coarse recognition, 32 kHz, 44.1 kHz, 48 kHz etc.). In *Clock Mode* the clock reference is shown. See also chapter 28.1.

8.2 Settings Dialog - Pitch

Usually soundcards and audio interfaces generate their internal clock (master mode) by a quartz. Therefore the internal clock can be set to 44.1 kHz or 48 kHz, but not to a value in between. SteadyClock, RME's sensational Low Jitter Clock System, is based on a Direct Digital Synthesizer (DDS). This superior circuitry can generate nearly any frequency with highest precision.

DDS has been implemented into the Babyface Pro with regard to the needs of professional video applications, as well as to maximum flexibility. The section Pitch includes both a list of typical video frequencies (so called pull up/pull down at 0.1% and 4%) and a fader to freely change the basic sample rate in steps of 1 Hz (!) over a range of +/- 5%.

! The Pitch function requires the Babyface Pro to be in clock mode Master (Internal)! The frequency setting will only be applied to this one specific Babyface Pro!

! Changing the sample rate during record/playback often results in a loss of audio, or brings up warning messages of the audio software. Therefore the desired sample rate should be set at least coarsely before starting the software.

Coarse

Coarse modification in steps of 50 Hz is done by clicking with the mouse to the left and right of the fader knob.

Fine

Fine modification in steps of 1 Hz is done by using the left/right cursor keys.

Reset

Ctrl key plus left mouse click.

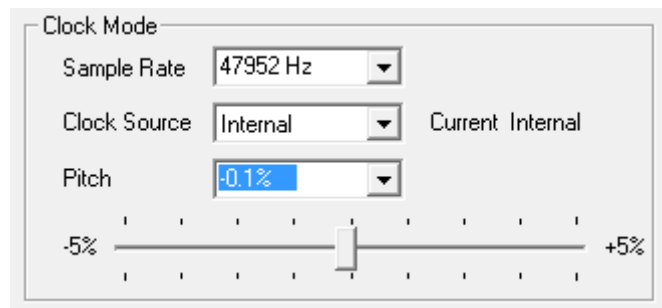

Application examples

Pitch allows for a simultaneous change of speed and tune during record and playback. From alignment to other sources up to creative effects – everything is possible.

Pitch enables you to intentionally de-tune the complete DAW. This way, the DAW can match instruments which have a wrong or unchangeable tuning.

Pitch allows for the change of the sample rate of all WDM devices at the same time. Since Vista this is no longer possible via the audio program, thus requires a manual reconfiguration of all WDM devices. Changing the sample rate from the Settings dialog solves this problem. As the change within the system requires some time, record/playback should not be started immediately, but only after at least 5 seconds after a change.

Tip: the current CPU load can be used to determine if the audio subsystem has finished the re-configuration.

9. Operation and Usage

9.1 Playback

In the audio application being used, Babyface Pro must be selected as output device. This can often be found in the *Options*, *Preferences* or *Settings* menus under *Playback Device*, *Audio Devices*, *Audio* etc.

! *WDM playback devices are not available if the number of WDM devices is set to 0 in the Settings dialog.*

We recommend switching all system sounds off (via *>Control Panel /Sounds<*). Although the Babyface Pro comes with extensive support for system audio, setting it to be the *Default Device* for playback could cause problems when working with ASIO.

Increasing the number and/or size of audio buffers may prevent the audio signal from breaking up, but also increases latency i.e. output is delayed. For synchronized playback of audio and MIDI (or similar), be sure to activate the checkbox 'Get position from audio driver'.

Note: Since Vista the audio application can no longer control the sample rate under WDM. Therefore the driver of the Babyface Pro includes a way to set the sample rate globally for all WDM devices within the Settings dialog, see chapter 8.1.

9.2 DVD-Playback (AC-3/DTS)

Popular DVD software players can send their audio data stream to any AC-3/DTS capable receiver via the Babyface Pro SPDIF output.

! *The sample rate must be set to 48 kHz in the Babyface Pro Settings dialog, or the software will only playback the down-mixed analog signal via SPDIF.*

In some cases a Babyface Pro output device has to be selected in *>Control Panel / Sound / Playback<* and be set as *Default*, or the software will not recognize it.

The DVD software's audio properties now show the options 'SPDIF Out' or similar. When selecting it, the software will transfer the non-decoded digital multichannel data stream to the Babyface.

Note: This 'SPDIF' signal sounds like chopped noise at highest level.

Multichannel

DVD software player can also operate as software decoder, sending a DVD's multichannel data stream directly to the analog outputs of the Babyface Pro. For this to work select the WDM playback device 'Loudspeaker' of the Babyface Pro in *>Control Panel/ Sound/ Playback <* as *Default*.

The playback software's audio properties now list several multichannel modes. If one of these is selected, the software sends the decoded analog multichannel data to the Babyface Pro. TotalMix can then be used to playback via any desired output channels.

The typical channel assignment for surround playback is:

1 – Left 2 – Right 3 – Center 4 - LFE (Low Frequency Effects)
5 - SL (Surround Left) 6 - SR (Surround Right)

Note 1: Selecting the Babyface Pro to be used as system playback device is against our recommendations, as professional interfaces should not be disturbed by system events. Make sure to re-assign the selection after usage or to disable any system sounds (tab Sounds, scheme 'No audio').

Note 2: The DVD player will be synced backwards from the Babyface Pro. This means when using AutoSync and/or word clock, the playback speed and pitch follows the incoming clock signal.

9.3 Notes on WDM

The driver offers one WDM streaming device per stereo pair, like **Analog 3+4 (Babyface Pro)**. WDM Streaming is Microsoft's current driver and audio system, directly embedded into the operating system. WDM Streaming is hardly usable for professional music purposes, as all data is processed by the so called Kernel Mixer, causing a latency of at least 30 ms. Additionally, WDM can perform sample rate conversions unnoticed, cause offsets between record and playback data, block channels unintentionally and much more.

Several programs do not offer any direct device selection. Instead they use the *playback device* selected in Windows under <Control Panel / Sound / Playback>.

Both the rare to find **WDM Kernel Streaming** and - under Windows 7 to 10 - **WASAPI Exclusive** bypass the WDM mixer.

Multi-Channel using WDM

The WDM Streaming device *Loudspeaker* (Analog 1+2) of the RME driver can operate as usual stereo device, or as up to 8-channel device.

An 8-channel playback using the Windows Media Player requires the speaker setup *7.1 Surround*. Configuration is done via >Control Panel / Sound / Playback / Loudspeaker / Configure <.

Via TotalMix FX the additional channels can then be sent to ADAT and thus to an external DA-converter.

9.4 Channel Count under WDM

The Babyface Pro's ADAT optical interface offers sample rates of up to 192 kHz using a standard ADAT recorder. For this to work single-channel data is spread to two or four ADAT channels using the *Sample Multiplexing* technique. This reduces the number of available ADAT channels from 8 to 4 or 2 per ADAT port.

Whenever the Babyface Pro changes into Double Speed (88.2/96 kHz) or Quad Speed mode (176.4/192 kHz) all devices no longer available vanish automatically.

WDM Stereo device	Double Speed	Quad Speed
Babyface Pro Analog (1+2)	Babyface Pro Analog (1+2)	Babyface Pro Analog (1+2)
Babyface Pro Analog (3+4)	Babyface Pro Analog (3+4)	Babyface Pro Analog (3+4)
Babyface Pro AS (1+2)	Babyface Pro AS (1+2)	Babyface Pro AS (1+2)
Babyface Pro ADAT (3+4)	Babyface Pro ADAT (3+4)	Babyface Pro ADAT (3+4)
Babyface Pro ADAT (5+6)	Babyface Pro ADAT (5+6)	Babyface Pro ADAT (5+6)
Babyface Pro ADAT (7+8)	Babyface Pro ADAT (7+8)	Babyface Pro ADAT (7+8)

Note: Since Vista the analog outputs 1/2 show up as *Loudspeaker*.

9.5 Multi-client Operation

RME audio interfaces support multi-client operation. Several programs can be used at the same time. The formats ASIO and WDM can even be used on the same playback channels simultaneously. As WDM uses a real-time sample rate conversion (ASIO does not), all active ASIO software has to use the same sample rate.

However, a better overview is maintained by using the channels exclusively. This is no limitation at all, because TotalMix allows for any output routing, and therefore a playback of multiple software on the same hardware outputs.

Inputs can be used from an unlimited number of WDM and ASIO software at the same time, as the driver simply sends the data to all applications simultaneously.

RME's sophisticated tool *DIGICheck* operates like an ASIO host, using a special technique to access playback channels directly. Therefore DIGICheck is able to analyse and display playback data from any software, no matter which format it uses.

9.6 Analog Recording

For recordings via the analog inputs the corresponding record device has to be chosen (Babyface Pro Analog (x+x)).

Channels 1 and 2 of the Babyface Pro have digitally controlled microphone preamps of the highest quality. The digital control offers a gain setting in steps of 1 dB within a range of 0 dB to +65 dB. The configuration is done either directly at the unit via the rotary encoder, or via the Settings panel of the input channels 1 and 2 in TotalMix, with the knob **Gain**. The current gain is displayed in dB beside the knob.

Additionally a PAD can attenuate the input signal by 11 dB, to prevent overloads by hard driven microphones or high level line signals. This useful feature extends the gain range and increases the maximum input level from +8 dBu up to +19 dBu at the XLR input.

Above the knob Gain the inputs can be set separately to provide **48V** phantom power at the XLR sockets. Phantom power is required for condenser microphones.



Input channels 3 and 4 are found as TS jacks on the right side of the Babyface Pro. These **Hi-Z universal inputs** have an input impedance of 1 MOhm. The input gain is controlled and performed digitally and limited to 9 dB. An additional hardware-based reference level optimizes the signal to noise ratio. Choices are +4 dBu and -10 dBV.

It often makes sense to monitor the input signal or send it directly to the output. This can be done at zero latency using **TotalMix FX** (see chapter 21).

An *automated* control of real-time monitoring can be achieved by Steinberg's ASIO protocol with RME's ASIO drivers and any ASIO 2.0 compatible program. When 'ASIO Direct Monitoring' has been switched on, the input signal is routed in real-time to the output whenever a recording is started (punch-in).

9.7 Digital Recording

Unlike analog soundcards which produce empty wave files (or noise) when no input signal is present, digital interfaces always need a valid input signal to start recording.

Taking this into account, RME added a comprehensive I/O signal status display to the Babyface Pro, showing sample frequency, lock and sync status in the Settings dialog, and a status LED directly at the unit.

The sample frequency shown in the Settings dialog is useful as a quick display of the current configuration of the unit and the connected external equipment. If no sample frequency is recognized, it will read 'No Lock'.

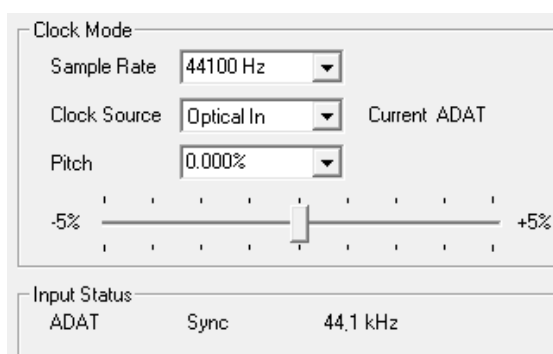

This way, configuring any suitable audio application for digital recording is simple. After connection the Babyface Pro displays the current and external sample frequency. This parameter can then be changed in the application's audio attributes (or similar) dialog.

9.8 Digital Connections

ADAT

The ADAT optical input of the Babyface Pro is fully compatible with all ADAT optical outputs. RME's unsurpassed Bitclock PLL prevents clicks and drop outs even in extreme varipitch operation, and guarantees a fast and low jitter lock to the digital input signal. A usual TOSLINK cable is sufficient for connection. More information on Double Speed (S/MUX) can be found in chapter 28.4.

ADAT In

Interface for a device sending an ADAT signal to the Babyface Pro. Carries the channels 1 to 8. When receiving a Double Speed signal, this input carries the channels 1 to 4, at Quad Speed the inputs 1 and 2.

ADAT Out

Interface for a device receiving an ADAT signal from the Babyface Pro. Transmits channels 1 to 8. When sending a Double Speed signal, this port carries channels 1 to 4, at Quad Speed the channels 1 and 2.

Note: To use the optical output as ADAT port set the option Optical to **ADAT** in the Settings dialog.

SPDIF

The optical input automatically switches to SPDIF operation when such a signal is detected. The audio information is then shown in TotalMix on the first two ADAT channels, AS 1 and AS 2.

Activating the option TMS in the Windows Settings dialog enables RME's DIGICheck to analyze the Channel Status of the input signal.

To send out SPDIF from the optical output, select the option *Optical – SPDIF* in the Settings dialog. The output signal in TotalMix has to be present on the first ADAT channels, AS 1+2.

MIDI

Babyface Pro offers one MIDI I/O via two 5-pin DIN jacks. The MIDI ports are added to the system by the driver. Using MIDI capable software, these ports can be accessed under the name *Babyface Pro Midi*. Using more than one Babyface Pro, the operating system adds a consecutive number to the port name, like *Babyface Pro MIDI (2)* etc.

The MIDI ports support multi-client operation. A MIDI input signal can be received by several programs at the same time. Even the MIDI output can be used by multiple programs simultaneously. However, due to the limited bandwidth of MIDI, this kind of application will often show various problems.

9.9 Clock Modes - Synchronization

In the digital world, all devices must be either Master (clock source) or Slave (clock receiver). Whenever several devices are linked within a system, there must always be a single master clock.

! *A digital system can only have one master! If the Babyface Pro's clock mode is set to 'Internal', all other devices must be set to 'Slave'.*

The Babyface Pro utilizes a very user-friendly, intelligent clock control, called **AutoSync**. Selecting *Optical* as Clock Source, the system constantly scans the digital input for a valid signal. If any valid signal is found, the Babyface Pro switches from the internal quartz (*Clock Source – Current Internal*) to a clock extracted from the input signal (*Clock Source – Current ADAT or SPDIF*). The difference to a usual slave mode is that whenever the clock reference fails, the system will automatically use its internal clock and operate in clock mode Master.

AutoSync guarantees that record and record-while-play will always work correctly. In certain cases however, e.g. when the inputs and outputs of a DAT machine are connected directly to the Babyface Pro, AutoSync may cause feedback in the digital carrier, so synchronization breaks down. To solve this problem switch the Babyface Pro clock mode to Master (Clock Source – Internal).

In some situations changing the clock mode can not be avoided. Example: A CD player is connected to the SPDIF input. Try recording a few samples from the CD and you will be disappointed - few CD players can be synchronized. The samples will inevitably be corrupted, because the signal from the CD player is read with the clock from the Babyface Pro, being out of sync. In this case, the Clock Source should be set temporarily to *Optical In*.

RME's exclusive **SyncCheck** technology (first implemented in the Hammerfall) enables an easy to use check and display of the current clock status. *Input Status* indicates whether there is a valid signal (Lock, No Lock) for the optical input, or if there is a valid *and* synchronous signal (Sync). In the field *Clock Source* the clock reference is shown. See chapter 28.1.

Under WDM the Babyface Pro will (has to) set the sample rate. Therefore the error shown to the right can occur. A stable signal with a sample rate of 32 kHz is detected at the ADAT input (Sync), but Windows audio had been set to 44100 Hz before. The red color of the text label signals the error condition, and prompts the user to set 32000 Hz manually as sample rate. Under ASIO the audio software sets the sample rate, so that such an error can not happen. If the input sample rate is different then there will be no Sync indication.

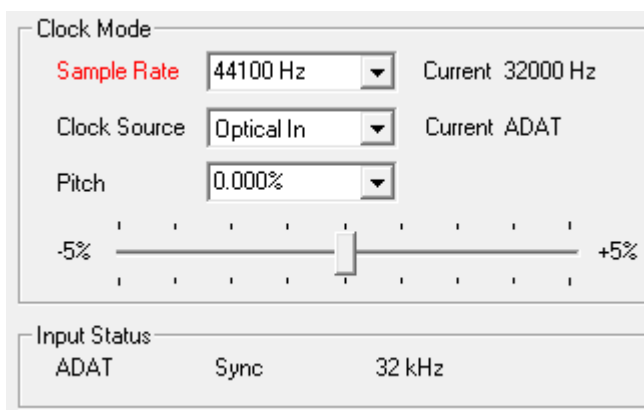

With RME's AutoSync and SyncCheck, finally anyone can master this common source of error, previously one of the most complex issues in the digital studio world.

10. Operation under ASIO

10.1 General

Start the ASIO software and select **ASIO Fireface USB** as the audio I/O device or the audio driver.

The Babyface Pro supports *ASIO Direct Monitoring* (ADM).

The Babyface Pro MIDI I/O can be used with both MME MIDI and DirectMusic MIDI.

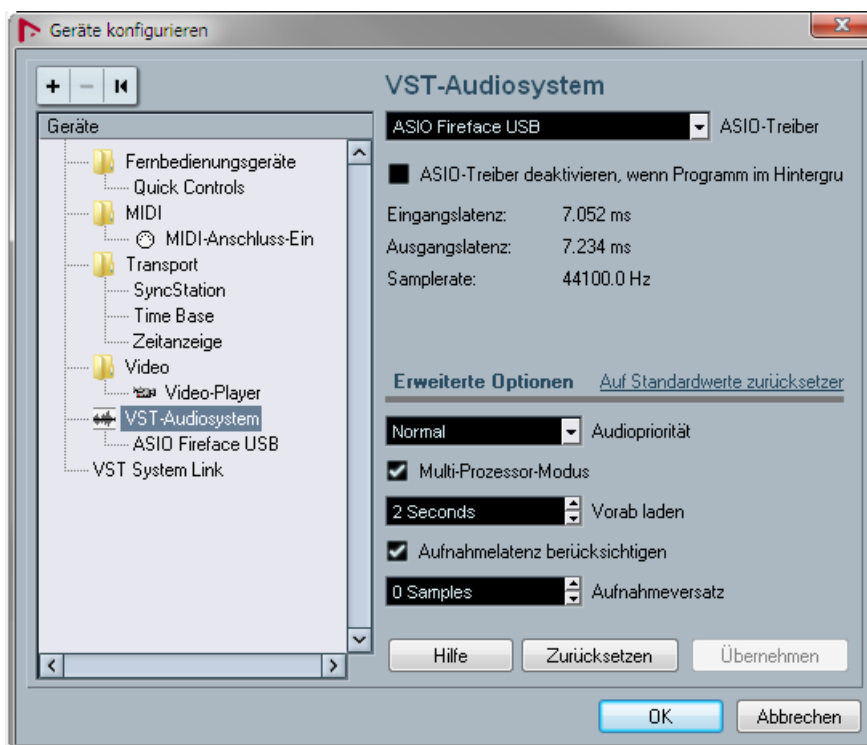

10.2 Channel Count under ASIO

At a sample rate of 88.2 or 96 kHz, the ADAT optical input and output operates in S/MUX mode, so the number of available channels is reduced from 8 to 4.

At a sample rate of 176.4 and 192 kHz, the ADAT optical input and output operates in S/MUX4 mode, so the number of available channels is limited to 2.

Note: When changing the sample rate range between Single, Double and Quad Speed the number of channels presented from the ASIO driver will change too. This may require a reset of the I/O list in the audio software.

Single Speed	Double Speed	Quad Speed
Babyface Pro Analog 1 to 4	Babyface Pro Analog 1 to 4	Babyface Pro Analog 1 to 4
Babyface Pro AS 1 to 2	Babyface Pro AS 1 to 2	Babyface Pro AS 1 to 2
Babyface Pro ADAT 3 to 4	Babyface Pro ADAT 3 to 4	Babyface Pro ADAT 3 to 4
Babyface Pro ADAT 5 to 6	Babyface Pro ADAT 5 to 6	Babyface Pro ADAT 5 to 6
Babyface Pro ADAT 7 to 8	Babyface Pro ADAT 7 to 8	Babyface Pro ADAT 7 to 8

10.3 Known Problems

If a computer does not provide sufficient CPU-power and/or sufficient USB-bus transfer rates, then drop outs, crackling and noise will appear. Such effects can be avoided by using a higher buffer setting/latency in the Settings dialog of the Babyface Pro. Furthermore PlugIns should be deactivated temporarily to make sure they do not cause these problems.

More information can be found in chapter 28.3.

Another common source of trouble is incorrect synchronization. ASIO does not support asynchronous operation, which means that the input and output signals not only have to use the same sample frequency, but also have to be in sync. All devices connected to the Babyface Pro must be properly configured for Full Duplex operation. As long as SyncCheck (in the Settings dialog) only displays *Lock* instead of *Sync*, the devices have not been set up properly!

The same applies when using more than one Babyface Pro - they all have to be in sync. Else a periodically repeated noise will be heard.

The Babyface Pro supports *ASIO Direct Monitoring* (ADM). Please note that not all programs support ADM completely or error-free. The most often reported problem is the wrong behaviour of panorama in a stereo channel. Also try to avoid setting the TotalMix FX hardware outputs (third row) to mono mode. This will most likely break ADM compatibility.

In case of a drift between audio and MIDI, or in case of a fixed deviation (MIDI notes placed close before or behind the correct position), the settings in Cubase/Nuendo have to be changed. At the time of print the option 'Use System Timestamp' should be activated. The Babyface Pro supports both MME MIDI and DirectMusic MIDI. It depends on the used application which one will work better.

11. Using more than one Babyface Pro

The current driver supports up to three RME USB devices. All units have to be in sync, i.e. have to receive valid digital sync information.

- If one of the units is set to clock mode Master, all others have to be set to clock mode Slave, and have to be synced from the master by feeding ADAT or SPDIF. The clock modes of all units have to be set up correctly in their Settings dialog.
- If all units are fed with a synchronous clock, i.e. all units show *Sync* in their Settings dialog, all channels can be used at once. This is especially easy to use under ASIO, as the ASIO driver presents all units as one.

Note: TotalMix FX is part of the hardware of each RME unit. Up to three mixers are available, but these are separated and can't interchange data. Therefore a global mixer for all units is not possible.

In real-world an operation of more than one Babyface Pro seems not very useful. The second unit must be synchronized using the optical input. The result is an extension by only 4 analog record and 4 analog playback channels (plus 8 digital via ADAT Out). It makes much more sense to directly connect an 8-channel converter to the ADAT I/O of one Babyface Pro, adding full 8 analog channels of record and playback.

On the other hand the second unit can even be used stand-alone, without any USB connection, and might serve as an emergency replacement in case the main unit fails.

12. DIGICheck Windows

The DIGICheck software is a unique utility developed for testing, measuring and analysing digital audio streams. Although this Windows software is fairly self-explanatory, it still includes a comprehensive online help. DIGICheck 5.93 operates as multi-client ASIO host, therefore can be used in parallel to any software, with both inputs and outputs (!). The following is a short summary of the currently available functions:

- **Level Meter.** High precision 24-bit resolution, 2/8/12 channels. Application examples: Peak level measurement, RMS level measurement, over-detection, phase correlation measurement, dynamic range and signal-to-noise ratios, RMS to peak difference (loudness), long term peak measurement, input check. Oversampling mode for levels higher than 0 dBFS. Supports visualization according to the K-System.
- **Hardware Level Meter for Input, Playback and Output.** Reference Level Meter freely configurable, causing near zero CPU load, because calculated from the Babyface Pro hardware.
- **Spectral Analyser.** World wide unique 10-, 20- or 30-band display in analog bandpass filter technology. 192 kHz-capable!
- **Vector Audio Scope.** World wide unique Goniometer showing the typical afterglow of a oscilloscope-tube. Includes Correlation meter and level meter.
- **Totallyser.** Spectral Analyser, Level Meter and Vector Audio Scope in a single window.
- **Surround Audio Scope.** Professional Surround Level Meter with extended correlation analysis, ITU weighting and ITU summing meter.
- **ITU1770/EBU R128 Meter.** For standardized loudness measurements.
- **Bit Statistics & Noise.** Shows the true resolution of audio signals as well as errors and DC offset. Includes Signal to Noise measurement in dB and dBA, plus DC measurement.
- **Channel Status Display.** Detailed analysis and display of SPDIF and AES/EBU Channel Status data.
- **Global Record.** Long-term recording of all channels at lowest system load.
- **Completely multi-client.** Open as many measurement windows as you like, on any channels and inputs or outputs!

DIGICheck is free but works only with RME interfaces. It is constantly improved and updated. The latest version is always available on our website www.rme-audio.com, section **Downloads / Software**.

13. Hotline – Troubleshooting

The input signal cannot be monitored in real-time

- ASIO Direct Monitoring has not been enabled within the DAW, and/or monitoring has been disabled globally (TotalMix Options).

The 8 ADAT channels don't seem to work

- The optical output has been switched to 'SPDIF' format. In TotalMix FX all channels and their assignments still exist, but the optical transmitter is then limited to two channels. The ADAT playback devices are still usable by routing and mixing them in TotalMix to other outputs.

Playback works, but record doesn't

- Check that there is a valid signal at the input. If so, the current sample frequency is displayed in the Settings dialog.
- Check whether the Babyface Pro has been selected as recording device in the audio application.
- Check whether the sample frequency set in the audio application ('Recording properties' or similar) matches the input signal.
- Check that cables/devices have not been connected in a closed loop. If so, set the system's clock mode to Master.

Crackle during record or playback

- Increase the number and size of buffers in the 'Settings' dialog or in the application.
- Try different cables (optical) to rule out any defects here.
- Check that cables/devices have not been connected in a closed loop. If so, set the system's clock mode to 'Master'.
- Check the Settings dialog for displayed Errors.

Driver installation and Settings dialog/TotalMix work, but a playback or record is not possible

- While recognition and control of the device are low bandwidth applications, playback/record needs the full USB transmission performance. Therefore, defective USB cables with limited transmission bandwidth can cause such errors.

Windows does not show the recording and playback channels of the Babyface Pro.

- WDM playback devices are not available if the number of WDM devices is set to 0 in the Settings dialog.

User's Guide



Babyface Pro *FS*

▶ **Installation and Operation – Mac OS X**

14. Hardware Installation

Connect computer and Babyface Pro with the supplied USB cable. Mac OS X detects the new hardware as **Babyface Pro (serial number)**.

In case the level meters of the Babyface Pro show **CC** during power-on, and Settings dialog and TotalMix FX refuse to start: the unit is in **Class Compliance** mode. Remove the USB cable, hold SELECT and DIM button down, plug-in the USB cable or the power supply. This procedure changes between CC and normal mode. When the Level meters change to **PC** the normal mode is active.

When using a power supply (stand-alone mode), holding down SELECT and DIM for more than two seconds repeatedly changes between PC and CC. Note that changing the operating mode is not supported during normal USB operation, so any USB connection has to be removed.

15. Driver and Firmware

15.1 Driver Installation

RME is constantly updating their drivers, and modern computers mostly do not have a CD drive anymore. Therefore please download the drivers from the RME website at <http://rme.to/downloads>. Unzip the downloaded file and start the driver installation by double-clicking **Fireface USB.pkg**.

During driver installation the programs **Totalmix** (TotalMix FX) and **Fireface USB Settings** are copied to the Applications folder. They will automatically start into the dock if a Babyface Pro is connected. A reboot of the computer is not required.

Driver Updates do not require to remove the existing drivers. Simply install the new driver over the existing one.

Possible reasons why a Babyface Pro is not found after driver installation:

- The USB port is not active in the system (check in System Profiler, USB)
- The USB cable is not, or not correctly inserted into the socket
- The Babyface Pro does not receive any or not enough power. Remove current-consuming hard drives from nearby ports. Avoid USB extension cables or USB hubs. Use an external power supply, any standard one delivering 9 - 14 V DC with at least 1 A will work. The connector needs to have – outside, + inside.

15.2 De-installing the Drivers

In case of problems the driver files can be deleted manually by dragging them to the trash bin:

```
/Applications/Fireface USB Settings
/Applications/Totalmix
/System/Library/Extensions/FirefaceUSB.kext
/Users/username/Library/Preferences/de.rme-audio.TotalmixFX.plist
/Users/username/Library/Preferences/de.rme-audio.Fireface_USB_Settings.plist
/Library/LaunchAgents/de.rme-audio.firefaceUSBAgent.plist
```

Under the latest Mac OS the User/Library folder is not visible in the Finder. To unhide it start Finder, click on the menu item Go. Hold down the option (alt) key, then click on Library.

15.3 Firmware Update

The Flash Update Tool updates the firmware of the Babyface Pro to the latest version. It requires an already installed driver. Please download the FUT from the RME website at <http://rme.to/downloads>.

Unzip the downloaded file and start the firmware update with **Fireface USB Flash**. The Flash Update Tool displays the current revision of the Babyface Pro firmware and whether it needs an update or not. If so, simply press the 'Update' button. A progress bar will indicate when the flash process is finished (Verify Ok).

After the update the unit needs to be reset. This is done by powering down the Babyface Pro for 5 seconds. A reboot of the computer is not necessary.

When the update fails (status: failure), the unit's second BIOS will be used from the next cold boot on (Secure BIOS Technology). Therefore the unit stays fully functional. The flash process should then be tried again on a different computer.

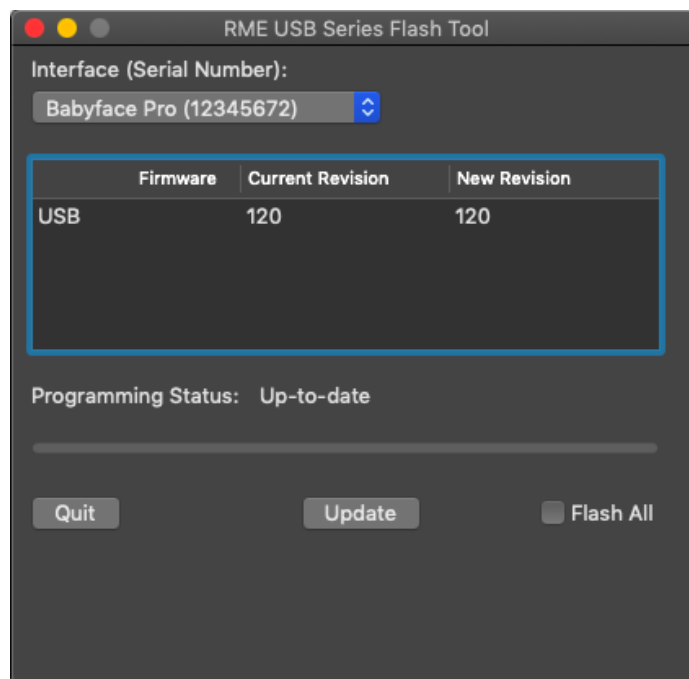

16. Configuring the Babyface Pro

16.1 Settings Dialog

Configuring the Babyface Pro is done via its own settings dialog. Start the program **Fireface USB Settings**. The mixer of the Babyface Pro (TotalMix FX) can be configured by starting the program **Totalmix**.

The Babyface Pro's hardware offers a number of helpful, well thought-out practical functions and options which affect how the card operates - it can be configured to suit many different requirements.

The following is available in the Settings dialog:

- Configuration of the digital I/O
- Current sample rate
- Synchronization behaviour
- State of input and output

Any changes performed in the Settings dialog are applied immediately - confirmation (e.g. by exiting the dialog) is not required.

However, settings should not be changed during playback or record if it can be avoided, as this can cause unwanted noises.

Use the drop down menu **Properties For** to select the unit to be configured.

On the right of it the current firmware and driver version is shown.

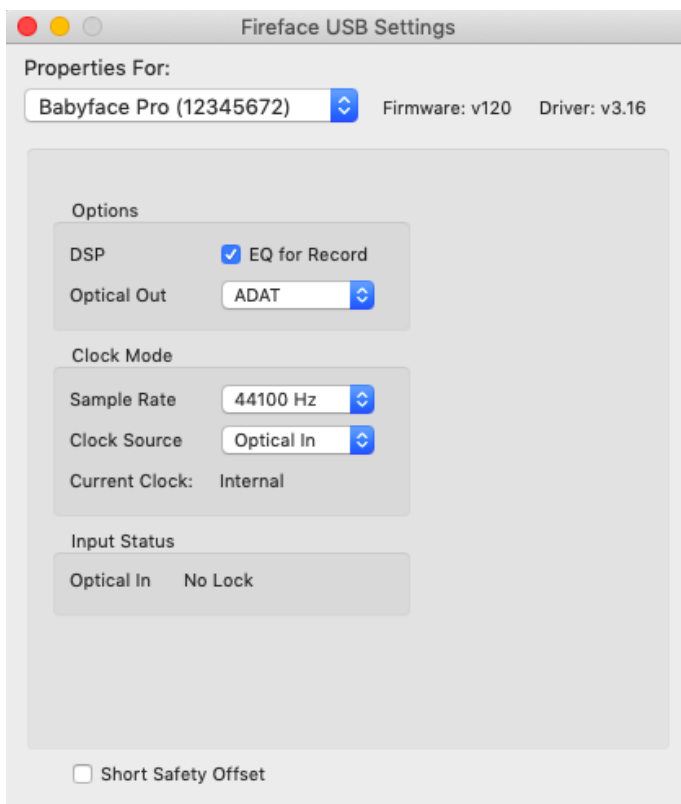

Options

DSP – EQ for Record

Switches the 3-band EQ and Low Cut of all input channels into the recording path. In case Loopback has been activated the EQ and Low Cut of the Output channel is placed into the recording path. See also chapter 23.6.

Optical Out

The optical TOSLINK output can operate as ADAT or SPDIF output. The Channel Status is fixed to Consumer state.

Note: The optical input detects the incoming format automatically.

Clock Mode

Sample Rate

Used to set the current sample rate. This is the same setting as in the Audio MIDI Setup, just added here for your convenience.

Clock Source

The unit can be configured to use its own clock (Internal = Master) or the digital input signal (Optical = Slave). If the external source isn't available (Input Status No Lock), the unit will change to the internal clock. The current clock source is displayed as *Current*.

Input Status

Indicates for the optical input whether there is a valid signal (Lock, No Lock), or if there is a valid *and* synchronous signal (Sync). The third column shows the sample frequency detected by the hardware (coarse recognition, 32 kHz, 44.1 kHz, 48 kHz etc.). In *Clock Mode* the clock reference is shown. See also chapter 28.1.

Short Safety Offset

Reduces overall latency by using smaller Safety Offsets. Change is performed in real-time. Smaller Safety Offsets might cause clicks and dropouts.

16.2 Clock Modes - Synchronization

In the digital world, all devices must be either Master (clock source) or Slave (clock receiver). Whenever several devices are linked within a system, there must always be a single master clock.

! *A digital system can only have one master! If the Babyface Pro's clock mode is set to 'Internal', all other devices must be set to 'Slave'.*

The Babyface Pro utilizes a very user-friendly, intelligent clock control, called **AutoSync**. Selecting *Optical* as Clock Source, the system constantly scans the digital input for a valid signal. If any valid signal is found, the Babyface Pro switches from the internal quartz (*Clock Mode* – Current Internal) to a clock extracted from the input signal (*Clock Mode* – Current ADAT or SPDIF). The difference to a usual slave mode is that whenever the clock reference fails, the system will automatically use its internal clock and operate in clock mode Master.

AutoSync guarantees that record and record-while-play will always work correctly. In certain cases however, e.g. when the inputs and outputs of a DAT machine are connected directly to the Babyface Pro, AutoSync may cause feedback in the digital carrier, so synchronization breaks down. To solve this problem switch the Babyface Pro clock mode to Master (Clock Source – Internal).

In some situations changing the clock mode can not be avoided. Example: A CD player is connected to the SPDIF input. Try recording a few samples from the CD and you will be disappointed - few CD players can be synchronized. The samples will inevitably be corrupted, because the signal from the CD player is read with the clock from the Babyface Pro, being out of sync. In this case, the Clock Source should be set temporarily to *Optical*.

RME's exclusive **SyncCheck** technology (first implemented in the Hammerfall) enables an easy to use check and display of the current clock status. *Input Status* indicates whether there is a valid signal (Lock, No Lock) for the optical input, or if there is a valid *and* synchronous signal (Sync). In the field *Clock Mode* the clock reference is shown. See chapter 28.1.

In practice, SyncCheck provides the user with an easy way of checking whether all digital devices connected to the system are properly configured. With AutoSync and SyncCheck, finally anyone can master this common source of error, previously one of the most complex issues in the digital studio world.

17. Mac OS X FAQ

17.1 MIDI doesn't work

In some cases the applications do not show the MIDI port. The reason for this is usually visible within the **Audio MIDI Setup – MIDI Window**. It displays no RME MIDI device, or the device is greyed out and therefore inactive. In most cases removing the greyed out device and again searching for MIDI devices will solve the problem.

The Babyface Pro is class compliant. Therefore it comes without a driver. OS X recognizes it as MIDI device and will be using it with the driver included in the operating system.

17.2 Repairing Disk Permissions

Repairing permission can solve problems with the installation process - plus many others. To do this, launch **Disk Utility** located in **Utilities**. Select your system drive in the drive/volume list to the left. The **First Aid** tab to the right now allows you to check and repair disk permissions.

17.3 Supported Sample Rates

RME's Mac OS X driver supports all sampling frequencies provided by the hardware. This includes **176.4 kHz** and **192 kHz**.

But not any software will support all the hardware's sample rates. The hardware's capabilities can easily be verified in the **Audio MIDI Setup – Audio Window**. Select the Babyface Pro. A click on **Format** will list the supported sample rates.

17.4 Channel Count under Core Audio

At a sample rate of 88.2 or 96 kHz, the ADAT optical input and output operates in S/MUX mode, so the number of available channels is reduced from 8 to 4.

At a sample rate of 176.4 and 192 kHz, the ADAT optical input and output operates in S/MUX4 mode, so the number of available channels is limited to 2.

It is not possible to change the number of Core Audio devices without a reboot of the computer. Therefore whenever the Babyface Pro changes into Double Speed (88.2/96 kHz) or Quad Speed mode (176.4/192 kHz) all devices stay present, but become partly inactive.

Single Speed	Double Speed	Quad Speed
Babyface Pro Analog 1 to 4	Babyface Pro Analog 1 to 4	Babyface Pro Analog 1 to 4
Babyface Pro AS 1 to 2	Babyface Pro AS 1 to 2	Babyface Pro AS 1 to 2
Babyface Pro ADAT 3 to 4	Babyface Pro ADAT 3 to 4	Babyface Pro ADAT 3 to 4
Babyface Pro ADAT 5 to 6	Babyface Pro ADAT 5 to 6	Babyface Pro ADAT 5 to 6
Babyface Pro ADAT 7 to 8	Babyface Pro ADAT 7 to 8	Babyface Pro ADAT 7 to 8

17.5 Various Information

The driver of the Babyface Pro requires at least Mac OS 10.6.

Programs that don't support card or channel selection will use the device chosen as **Input** and **Output** in the **System Preferences – Sound** panel.

Via **Launchpad – Other – Audio MIDI Setup** the Babyface Pro can be configured for the system wide usage in more detail.

Programs that don't support channel selection will always use channels 1/2, the first stereo pair. To access other inputs, use the following workaround with TotalMix: route the desired input signal to output channels 1/2. In the channel settings of outputs 1/2 activate *Loopback*. Result: the desired input signal is now available at input channel 1/2, without further delay/latency.

Use **Configure Speakers** to freely configure the stereo or multichannel playback to any available channels.

18. Using more than one Babyface Pro

OS X supports the usage of more than one audio device within an audio software. This is done via the Core Audio function **Aggregate Devices**, which allows to combine several devices into one. All units have to be in sync, i.e. have to receive valid sync information via a digital input signal.

- If one of the devices is set to clock mode Master, all others have to be set to clock mode Slave, and have to be synced from the master by feeding ADAT or SPDIF. The clock modes of all units have to be set up correctly in their Settings dialog.
- If all units are fed with a synchronous clock, i.e. all units show *Sync* in their Settings dialog, all channels can be used at once.

Note: TotalMix is part of the hardware of each device. Up to three mixers are available, but these are separated and can't interchange data. Therefore a global mixer for all units is not possible.

In real-world an operation of more than one Babyface Pro seems not very useful. The second unit must be synchronized using the optical input. The result is an extension by only 4 analog record and 4 analog playback channels (plus 8 digital via ADAT Out). It makes much more sense to directly connect an 8-channel converter to the ADAT I/O of one Babyface Pro, adding full 8 analog channels of record and playback.

On the other hand the second unit can even be used stand-alone, without any USB connection, and might serve as an emergency replacement in case the main unit fails.

19. DIGICheck Mac

The DIGICheck software is a unique utility developed for testing, measuring and analysing digital audio streams. Although this Windows software is fairly self-explanatory, it still includes a comprehensive online help. DIGICheck 0.73 operates in parallel to any software, showing all input data. The following is a short summary of the currently available functions:

- **Level Meter.** High precision 24-bit resolution, 2/8/12 channels. Application examples: Peak level measurement, RMS level measurement, over detection, phase correlation measurement, dynamic range and signal-to-noise ratios, RMS to peak difference (loudness), long term peak measurement, input check. Oversampling mode for levels higher than 0 dBFS. Supports visualization according to the K-System.
- **Hardware Level Meter for Input, Playback and Output.** Reference Level Meter freely configurable, causing near zero CPU load, because calculated from the Babyface Pro hardware.
- **Spectral Analyser.** World wide unique 10-, 20- or 30-band display in analog bandpass filter technology. 192 kHz-capable!
- **Vector Audio Scope.** World wide unique Goniometer showing the typical afterglow of a oscilloscope-tube. Includes Correlation meter and level meter.
- **Totalyser.** Spectral Analyser, Level Meter and Vector Audio Scope in a single window.
- **Surround Audio Scope.** Professional Surround Level Meter with extended correlation analysis, ITU weighting and ITU summing meter.
- **ITU1770/EBU R128 Meter.** For standardized loudness measurements.
- **Bit Statistics & Noise.** Shows the true resolution of audio signals as well as errors and DC offset. Includes Signal to Noise measurement in dB and dBA, plus DC measurement.
- **Completely multi-client.** Open as many measurement windows as you like, on any channels and inputs or outputs!

DIGICheck is constantly updated. The latest version is always available on our website www.rme-audio.com, section **Downloads / Software**.

20. Hotline – Troubleshooting

The unit and drivers have been installed correctly, but playback does not work:

- Is Babyface Pro listed in the System Profiler?
- Has Babyface Pro been selected as current playback device in the audio application?

The 8 ADAT channels don't seem to work

- The optical output has been switched to 'SPDIF' format. In TotalMix FX all channels and their assignments still exist, but the optical transmitter is then limited to two channels. The ADAT playback devices are still usable by routing and mixing them in TotalMix to other outputs.

Playback works, but record doesn't:

- Check that there is a valid signal at the input. If so, the current sample frequency is displayed in the Settings dialog.
- Check whether the Babyface Pro has been selected as recording device in the audio application.
- Check whether the sample frequency set in the audio application ('Recording properties' or similar) matches the input signal.
- Check that cables/devices have not been connected in a closed loop. If so, set the system's clock mode to 'Master'.

Crackle during record or playback:

- Increase the number and size of buffers in the application.
- Try different cables (coaxial or optical) to rule out any defects here.
- Check that cables/devices have not been connected in a closed loop. If so, set the system's clock mode to 'Master'.

Driver installation and Settings dialog/TotalMix work, but a playback or record is not possible

- While recognition and control of the device are low bandwidth applications, playback/record needs the full USB transmission performance. Therefore, defective USB cables with limited transmission bandwidth can cause such an error scheme.



User's Guide



Babyface Pro *FS*

▶ TotalMix FX

21. Routing and Monitoring

21.1 Overview

The Babyface Pro includes a powerful digital real-time mixer, based on RME's unique, sample-rate independent **TotalMix** technology. It allows for practically unlimited mixing and routing operations, with all inputs and playback channels simultaneously, to any hardware outputs. TotalMix FX adds 3-band parametric equalizer, low cut, echo and reverb.

Here are some typical applications for TotalMix:

- Setting up delay-free submixes (headphone mixes). The Babyface Pro allows for up to 6 fully independent stereo submixes. On an analog mixing desk, this would equal 12 Aux sends.
- Unlimited routing of inputs and outputs (free utilisation, patchbay functionality).
- Distributing signals to several outputs simultaneously. TotalMix offers state-of-the-art splitter and distributor functions.
- Simultaneous playback of different programs via a single stereo output. The ASIO multi-client driver supports the usage of several programs at the same time. If this happens on different playback channels TotalMix provides the means to mix and monitor these on a single stereo output.
- Mixing of the input signal to the playback signal (complete ASIO Direct Monitoring). RME is not only *the* pioneer of ADM, but also offers the most complete implementation of the ADM functions.
- Integration of external devices. Use TotalMix to insert external effects devices, be it in the playback or in the record path. Depending on the current application, the functionality equals insert or effects send and effects return, for example as used during real-time monitoring when adding some reverb to the vocals.

Every single input channel, playback channel and hardware output features a Peak and RMS level meter, calculated in hardware. These level displays are very useful to determine the presence and routing destinations of the audio signals.

For a better understanding of the TotalMix mixer you should know the following:

- As shown in the block diagram (next page), the record signal usually stays un-altered. TotalMix does not reside within the record path, and does not change the record level or the audio data to be recorded (exceptions: *EQ for Record* and *Loopback* mode).
- The hardware input signal can be passed on as often as desired, even with different levels. This is a big difference to conventional mixing desks, where the channel fader always controls the level for all routing destinations simultaneously.
- The level meters of input and playback channels are connected pre-fader, to be able to visually monitor where a signal is currently present. The level meters of the hardware outputs are connected post-fader, thus displaying the actual output level.

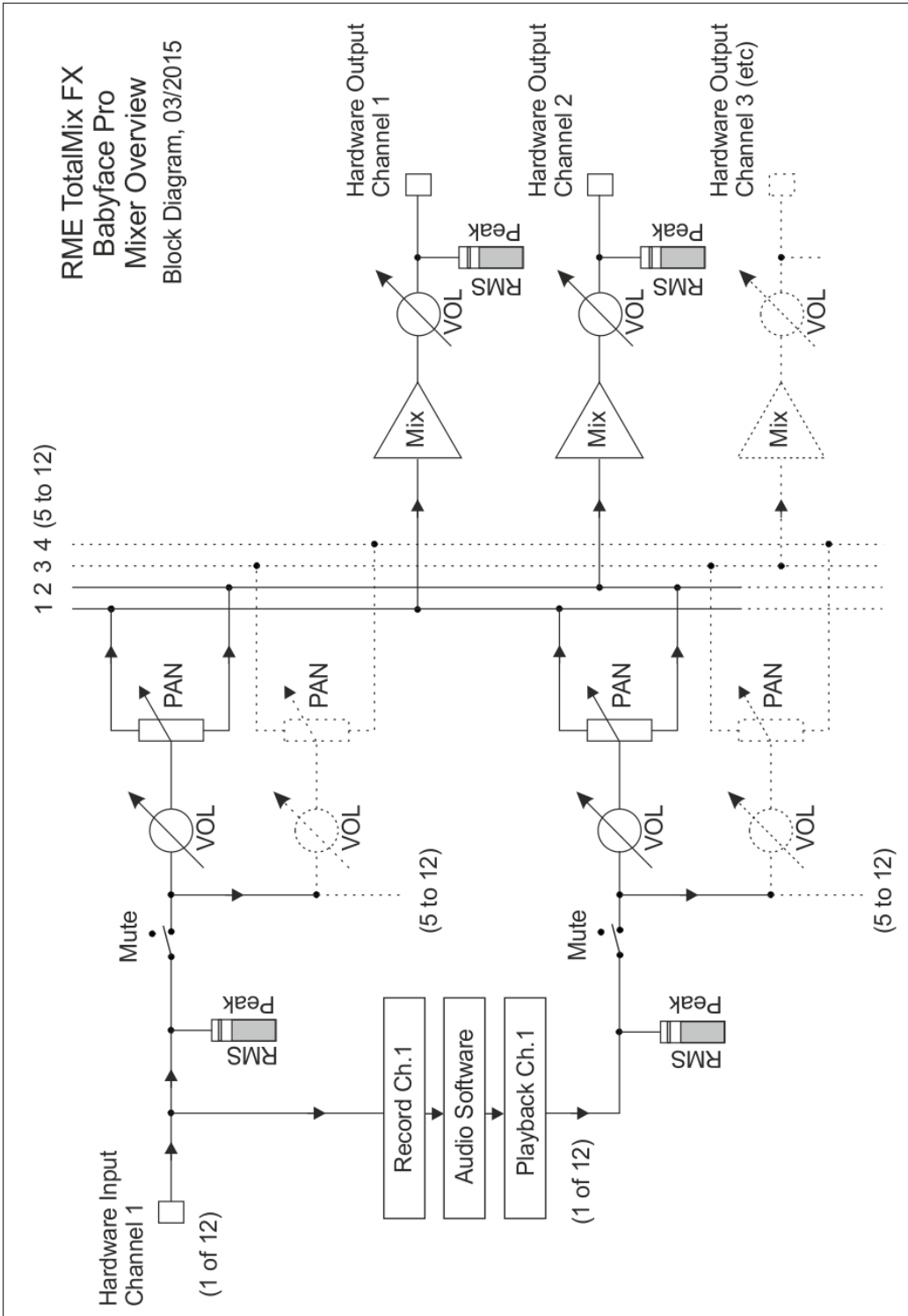

21.2 The User Interface

The visual design of the TotalMix mixer is a result of its capability to route hardware inputs and software playback channels to any hardware output. The Babyface Pro has 12 input channels, 12 software playback channels, and 12 hardware output channels:

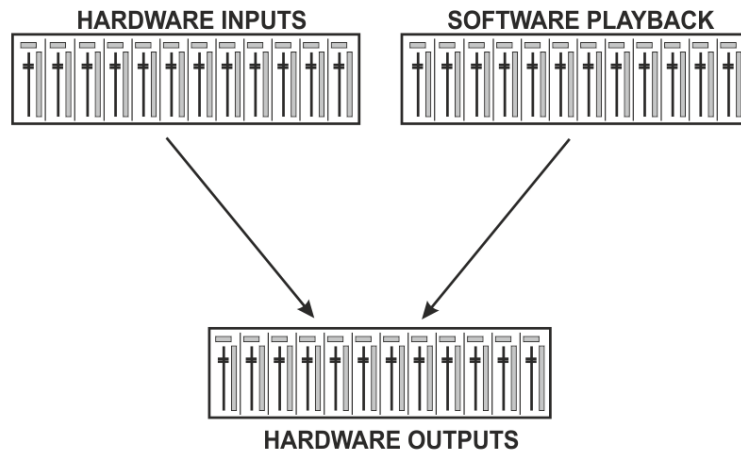

TotalMix can be used in the above view (View Options **2 Rows**). However, the default is a vertical alignment in three rows as known from an Inline desk, so that the row *Software Playback* equals the *Tape Return* of a real mixing desk:

- Top row: Hardware inputs. The level shown is that of the input signal, i.e. fader independent. Via fader and routing menu, any input channel can be routed and mixed to any hardware output (bottom row).
- Middle row: Playback channels (playback tracks of the audio software). Via fader and routing menu, any playback channel can be routed and mixed to any hardware output (bottom row).
- Bottom row: Hardware outputs. Here, the total level of the output can be adjusted. This may be the level of connected loudspeakers, or the level of any submix.

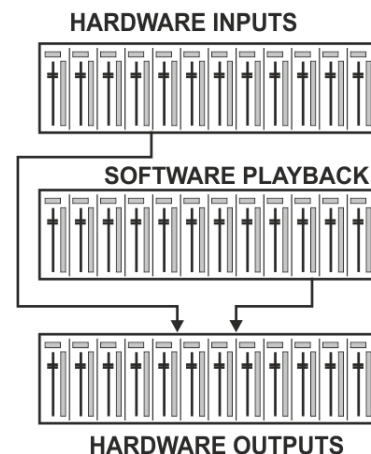

Usage in mode Submix View (Default)

Click on the Hardware Output channel in the third row where the audio signal is supposed to show up. This channel turns brighter, means it is selected as current submix. Now move the faders up from all sources – these are the input and playback channels, in the first and second row. That's it. The input (monitoring) and playback (DAW software) audio signals are now available at that very output, which can be verified immediately from the level meters reacting accordingly.

The following chapters explain step by step all functions of the user interface.

21.3 The Channels

A single channel can be switched between mono and stereo mode. The mode is set in the channel settings.

Channel name. The name field is the preferred place to select a channel by a mouse click. A double click opens a dialog to assign a different name. The original name will be shown when activating the option *Names* in the View Options.

Panorama. Routes the input signal freely to the left and right routing destination (lower label, see below). The level reduction in center position is -3 dB.

Mute and Solo. Input channels and playback channels each have a mute and solo button.

Numerical level display. Shows the current RMS or Peak level, updated twice per second. OVR means overload. The setting Peak/RMS is changed in the View Options.

Level meter. The meter shows both peak values (zero attack, 1 sample is enough for a full scale display) by means of a yellow line, and mathematically correct RMS values by means of a green bar. The RMS display has a relatively slow time constant, so that it shows the average loudness quite well. Overs are shown in red at the top of the bar. In the Preferences dialog (F2) the Peak Hold time, the over detection and the RMS reference can be set.



Fader. Determines the gain/level of the signal routed to the current routing destination (lower label). Please note that this fader is not *the* fader of the channel, but only the fader of the current routing. Compared to a standard mixing desk TotalMix does not have a channel fader, but only Aux Sends, as many as there are hardware outputs. Therefore TotalMix can create as many different Submixes as there are hardware outputs. This concept is understood best in the Submix View, but more on that later.

Below the fader the **Gain** is shown in a numerical display field, according to the current fader position. The fader can be:

- dragged with the left mouse button pressed
- moved by the mouse wheel
- set to 0 dB and $-\infty$ by a double click. The same happens with a single click plus held down Ctrl key.
- adjusted in fine mode by mouse drag and mouse wheel when holding the Shift key down

A Shift-click on a fader adds the fader to the **temporary fader group**. All faders now marked yellow are ganged, and move simultaneously in a relative way. The temporary fader group is deleted by a click on the F symbol in the upper right of the window.



The **arrow symbol** at the bottom minimizes the channel width to that of the level meters. Another click maximizes it again. A mouse click with held Ctrl key causes all channels to the right to enlarge and minimize at once.

The lowest field shows the current **routing target**. A mouse click opens the routing window to select a routing target. The list shows all activated routings of the current channel by arrows in front of the listed entries, the current one is shown in bold letters.



An arrow is only shown with an activated routing. A routing is seen as activated when audio data is sent. As long as the fader is set to $-\infty$ the current routing will be shown in bold letters, but not have an arrow in the front.

Trim Gain. After a click on the **T**-button one channel's faders are all synchronized. Instead of changing only a single routing the fader affects all the channel's active routings. For a better overview the faders currently not visible are indicated by orange triangles beside the fader path. When moving the fader the triangles also move to a new position, equalling the faders new settings.

Note that the fader button is set to the highest routing gain of all routings so that best control is offered. The gain (fader knob position) of the currently active routing (the submix selected in the third row) is shown as white triangle.

Background: TotalMix has no fixed channel fader. In case of the Babyface Pro there are 6 stereo Aux sends, shown alternately as single fader within the channel strip. The high number of Aux sends enables multiple and fully independent routings.

In some cases it is necessary to synchronize the gain changes of these routings. An example is the Post fader function, where a change of the singer's volume shall be performed identical to the volume change of the signal sent to the reverb device, so that the reverb level keeps its relation to the original signal. Another example is the signal of a guitar that is routed to different submixes, means hardware outputs, which gets much too loud during the solo part, and therefore needs to be reduced in volume on all outputs simultaneously. After a click on the Trim button this can be done easily and with a perfect overview.



As all channel's routings change simultaneously when Trim is active, this mode basically causes the same behaviour as a trim pot within the input channel, affecting the signal already before the mixer. That's how this function got its name.

In the View Options - *Show* the function Trim Gains can be globally switched on and off for all channels. The global Trim mode is recommended when using TotalMix FX as live mixing desk.

The Context Menu. With a right click on the input, playback and output channels their context menus provide advanced functionality (these menus are also available in the Matrix, but only directly on the channel labels). The entries are self-explanatory and automatically adjust to where the click is performed. On all of these the first entry opens the *Channel Layout* dialog. The input channels offer *Clear*, *Copy input*, *paste the input mix* and *paste its FX*. On a playback channel *Copy*, *Paste* and *Clear the playback mix* are available. On an output channel *Copy* and *Mirror* functionality for the current submix and *copying* of the FX settings is offered.

A click on the tool symbol opens the channel's **Settings** panel with differing elements. For example the Option PAD exists only in input channel 1/2, and the ADAT channels do not offer the phantom power option.

Stereo. Switches the channel to mono or stereo mode.

48V. Activates phantom power at the corresponding input. Serves as power supply for high quality condenser mics. This option should stay off with other sources to prevent failure by spikes.

PAD. Applies -11 dB damping for the XLR input signal. Also increases the input impedance.

Gain. Sets the gain for both analog inputs. The knob can be adjusted by dragging the mouse or by the mouse wheel. This also works when the mouse has been moved over the two gain displays. Then the gain can be changed separately for left and right channel, even when the channel is in stereo mode.

Width. Setting the stereo width. 1.00 equals full stereo, 0.00 mono, -1.00 swapped channels.

FX Send. Setting the level of the signal sent to the FX bus which feeds Echo and Reverb. The current setting is also visible with closed channel settings, because knob and small fader are always synchronized. To make this function as useful as possible FX Send is locked to the highest submix, thus imitating the *Aux Post Fader* function of a standard mixing desk. When moving the big fader both knob and small fader will also move. This way the reverb signal will always have the same relation to the dry signal.

The level of the signal sent to the effects can be controlled by the *FX In* level meters of the FX window. It becomes visible after a click on FX in the View Options.

MS Proc. Activates M/S processing within the stereo channel. Monaural information is sent to the left channel, stereo information to the right.

Phase L. Inverts the phase of the left channel by 180°.

Phase R. Inverts the phase of the right channel by 180°.

AN1→ 2. Available only in stereo mode of the AN 1/2 input pair. Copies the signal of input channel 1 (Mic/Line 1) to channel 2. Typical application: A microphone should be audible on both channels of a stereo recording.

Note: the functions Width, MS Proc, Phase L, Phase R and AN1→ 2 affect all routings of the respective channel.

Besides Stereo/Mono, Phase L und Phase R the settings of the Hardware Outputs have further options:

Note: Setting the reference level of both XLR outputs is done by a sliding switch on the bottom of the device (+4 dBu or +19 dBu).

FX Return. The effect signal (Echo and Reverb) is mixed to the respective hardware output by the duo knob/small fader.



Talkback. Activates this channel as receiver and output of the Talkback signal. This way Talkback can be sent to any outputs, not only the Phones in the Control Room section. Another application could be to send a certain signal to specific outputs by the push of a button.

No Trim. Sometimes channels need to have a fixed routing and level, which should not be changed in any case. An example is the stereo mixdown for recording of a live show. With *No Trim* active, the routing to this output channel is excluded from the Trim Gains function, therefore is not changed unintentionally.

Loopback. Sends the output data to the driver as record data. The corresponding submix can be recorded then. This channel's hardware input sends its data only to TotalMix, no longer to the recording software.

Another difference to the input and playback channels is the **Cue** button instead of Solo. A click on Cue sends the respective Hardware Output's audio to the **Main** Out, or any of the Phones outputs (option *Assign / Cue to* in the Control Room section). With this any hardware output can be controlled and listened to through the monitoring output very conveniently.



A click on EQ opens the **Equalizer** panel. It is available in all input and output channels, and affects all routings of the respective channel (pre fader). The panel includes a low cut and a 3-band parametric equalizer which can be activated separately.

EQ. Activated by the EQ button.

Type. Band 1 and 3 can operate in peak (bell) or shelf (shelving) mode. The middle band is fixed to peak mode.

Gain. All three bands can change their amplitude (amplification) between +20 dB to -20 dB.

Freq. The center frequency of the filter is adjustable between 20 Hz and 20 kHz. While in peak mode the center frequency is adjusted, in shelf mode the cut-off point (-3 dB) will be changed.

Q. The Quality factor of the filter is adjustable from 0.7 (wide) to 5.0 (narrow).

Lo Cut. Activated by the button Lo Cut. The slope of the high-pass filter is adjustable between 6, 12, 18 and 24 dB per octave. The cut-off point (-3 dB) is adjustable between 20 Hz and 500 Hz.



The frequency graphics give a precise overview of the filter results. Overlapping filters influence each other. This can be used to achieve more than 20 dB amplitude, or to generate difficult frequency response optimizations.

Note: TotalMix has an internal headroom of 24 dB. Extreme boosts with overlapping filters can therefore cause an internal overload. In any case such an overload is displayed by the Over LED of the channel's level meter.

Preset. Settings of the EQ and the Low Cut can be stored, loaded, and copied between channels at any time. A click on Preset opens a menu with several entries:

- **Recall:** Presets stored before by the user can be selected and loaded
- **Save to:** There are 16 storage places available (EQ Preset 1 to 16)
- **Import:** Loads a previously stored TM EQ file (.tmeq)
- **Export:** Stores the current state as TM EQ file (.tmeq)
- **Factory:** Includes 14 examples for the creative use of Low Cut and Equalizer
- **Reset:** Resets the Low Cut and EQ to have zero influence (Gain 0 dB)
- **Rename:** The EQ Presets 1 to 16 can be renamed. The changes will be shown in both lists Recall and Save to.

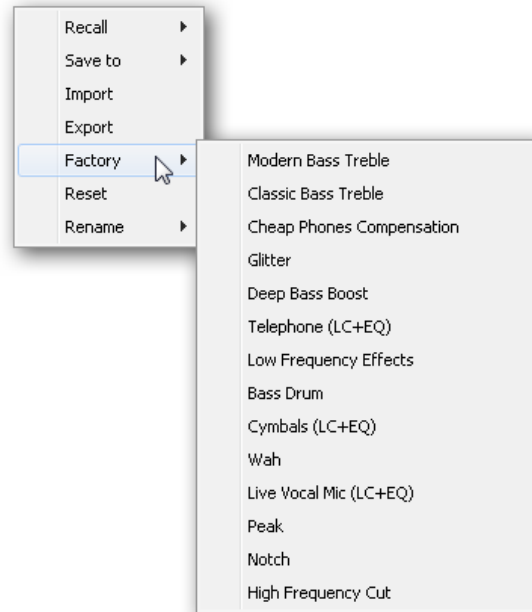

Notes on the EQ Presets

Copy between channels: The EQ Preset menu of all channels is identical. If an EQ setup is stored via *Save to* on one of the 16 storage places, it is then also available in any other channel via *Recall*.

Copy between Snapshots: The Presets are not saved in Snapshots, therefore do not change when a different Snapshot is loaded. Presets are saved in Workspaces and also loaded with these.

Copy between Workspaces: is done by the export and import function of the Preset menu. Important and useful Presets should always be saved as TM EQ file, so that they can not get lost even on accidental overwrite.

Factory Presets: loads like all Presets the settings of both Low Cut and EQ simultaneously. The current state, On or Off, is neither saved nor activated on load. With this a preset can be loaded anytime, but will not become active before the user decides to switch the EQ and/or LC on – except they had been active already before the load process. For this reason some Factory Presets have special names. For example Telephone (LC+EQ) will sound much better when the LC has been activated additionally to the EQ, as the LC is set to an unusual high frequency of 500 Hz here.

21.4 Section Control Room

In the section Control Room the menu *Assign* is used to define the **Main Out** which is used for listening in the studio. For this output the functions Dim, Recall, Mono, Talkback, External Input and Mute FX are automatically applied. On the unit the button DIM also follows this assignment.

Additionally the channel will be shifted from the Hardware Outputs into the Control Room section, and renamed *Main*. The same happens when assigning Main Out B or the Phones. The original name can be displayed by the function *Names* in the View Options - Show at any time.

Phones 1 and 2 will have dim (set in Settings) and a special routing applied when Talkback is activated. Also putting them beside the Main Out increases the overview within the output section greatly.

Dim. The volume will be reduced by the amount set in the Settings dialog (F3).

Recall. Sets the gain value defined in the Settings dialog. Can also be set at the unit in Output mode by holding down the SET button for two seconds.

Speaker B. Switches audio from Main Out to Main Out B. The faders of the channels Main and Speaker B can be ganged via Link. Via *Options / Key Commands* switching to Speaker B can also be controlled by the unit's **OUT, A, B** and **DIM** button.

Mono. Mixes left and right channel. Useful to check for mono compatibility and phase problems.

Talkback. A click on this button will dim all signals on the *Phones* outputs by an amount set up in the Settings of TotalMix FX. At the same time the control room's microphone signal (source defined in Settings) is sent to the *Phones*. The microphone level is adjusted with the channel's input fader.

External Input. Switches Main monitoring from the mix bus to the stereo input defined in the Settings dialog (F3). The relative volume of the stereo signal is adjusted there as well.

Mute FX. Mutes Reverb and Echo on the Main Out, to hear the mix without those effects.

Assign. Allows to define the Main Out, Main Out B, and up to two Phones outs.

The output for the Cue signal, which is usually Main, can also be set to one of the Phones outputs. The setting *Cue/PFL to* also controls the PFL monitoring.

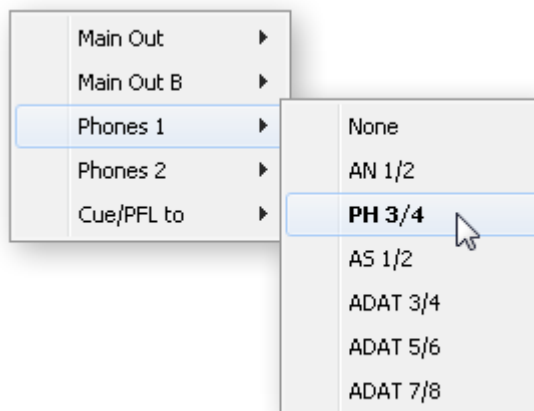

21.5 The Control Strip

The Control Strip on the right side is a fixed element. It combines different functions that are either required globally, or constantly used, and therefore should not be hidden in a menu. It can still be hidden via the top menu Window – Hide Control Strip.

The areas described in the following chapters can be minimized by a click on the arrow in their title bar.

Device selection. Select the unit to be controlled in case more than one is installed on the computer.

FX - DSP Meter. Shows the DSP load caused by activated EQs and Low Cuts. The DSP of the Babyface Pro has been designed so that an overload cannot occur. The display therefore is for information purposes only.

Undo / Redo. With the unlimited Undo and Redo changes of the mix can be undone and redone, at any time. Undo/Redo does not cover graphical changes (window size, position, channels wide/narrow etc.), and also no changes to the Presets. The accidental overwrite of an EQ Preset can not be undone.

Undo/Redo also operates across Workspaces. Therefore a completely differently set up mixer view can be loaded via Workspace, and with a single click on Undo the previous internal mixer state is returned – but the new mixer view stays.



Global Mute Solo Fader.

Mute. Global Mute operates in a pre fader style, muting all currently activated routings of the channel. As soon as any Mute button is pressed, the *Mute Master* button lights up in the Control Strip area. With this button all selected mutes can be switched off and on again. One can comfortably set up a mute group or activate and deactivate several mute buttons simultaneously.

Solo. As soon as any Solo button is pressed, the *Solo Master* button lights up in the Control Strip area. With this button all selected Solos are switched off and on again. Solo operates as Solo-in-Place, post fader style, as known from common mixing desks. A typical limitation for mixing desks, Solo working only globally and only for the Main Out, does not exist in TotalMix. Solo is always activated for the current submix only.

Fader. A Shift-click on a fader adds the fader to the **temporary fader group**. All faders now marked yellow are ganged, and move simultaneously in a relative way. The temporary fader group is deleted by a click on the F symbol.

21.5.1 View Options

The field **View Options** combines different functions of routing, the level meters and the mixer view.

Routing Mode

- **Submix:** The Submix view (default) is the preferred view and delivers the quickest overview, operation and understanding of TotalMix. The click on one of the Hardware Output channels selects the respective submix, all other outputs are darkened. At the same time all routing fields are set to this channel. With Submix view, it is very easy to generate a submix for any output: select the output channel, adjust the fader and pans of first and second row – finished.
- **Free:** The Free view is for advanced users. It is used to edit several submixes simultaneously, without the need to change between them. Here one works with the routings fields of the input and playback channels only, which then show different routing destinations.



Level Meters

- **Post FX.** Switches all level meters before (pre) or after (post) the effects. Level changes by these can be easily checked using this feature. Additionally the input signal can be checked for overloads. It is recommended to use Post FX as default setting, as the extreme reduction of a signal by LC/EQ is very seldom. Also all the Over displays of all level meters operate both pre and post, efficiently preventing overloads going unnoticed.
- **RMS.** The numerical level display in the channels displays peak or RMS.

Show

- **FX.** Opens the window to set up the effects Reverb and Echo.
- **Trim.** Activates all Trim buttons on all channels. TotalMix thus behaves like a conventional, simple mixing desk. Each fader affects all active routings of the channel simultaneously, as if the fader were a trim-pot in the hardware input.
- **2 Row.** Switches the mixer view to 2 rows. Hardware Inputs and Software Playbacks are placed side by side. This view saves a lot of space, especially in height.
- **Names.** Display of the original names of channels when they had been renamed by the user.

21.5.2 Snapshots - Groups

Snapshots. Snapshots include all mixer settings, but no graphical elements like window positions, window size, number of windows, visible EQs or Settings, scroll states, Presets etc. Only the state wide/narrow of the channels is registered. Moreover the Snapshot is only temporarily stored. Loading a Workspace causes the loss of all stored Snapshots, when these all had not been saved before in a Workspace, or separately via *File / Save Snapshot as*. Via *File / Load Snapshot* the mixer states can be loaded individually.

8 different mixes can be stored under individual names in the Snapshot section. A click on any of the 8 buttons loads the corresponding Snapshot. A double click on the name field opens the dialog *Input Name* to edit the name. As soon as the mixer state is changed the button starts flashing. A click on Store lets all buttons flash, whereby the last loaded one, the base of the current state, flashes inversely. The storage finishes by clicking the desired button (means storage place). The storage process is exited by another click on the flashing Store button.

The area Snapshots can be minimized by a click on the arrow in the title bar.

Groups. The area Groups provides 4 storage places each for fader, mute and solo groups. The groups are valid per Workspace, being active and usable in all 8 Snapshots. But with this they are also lost when loading a new workspace, in case they have not been saved before in a different Workspace.

Note: The Undo function will help in case of an accidental overwrite or deletion of the groups.

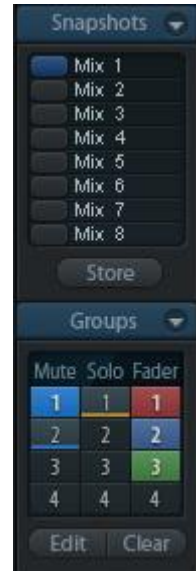

TotalMix uses flashing signals to guide you through the group setup. After a click on Edit and click on the desired storage place all desired functions for this group have to be activated or selected. The storage process is finished by another click on Edit.

When setting up a fader group make sure to not add faders that are at the most top or lowest position, except all faders of that group have this position.

The Mute groups operate – other than the global mute – exclusively for the current routing. This way you can not mute signals on all outputs unintentionally. Instead signals can be muted on specific submixes by the push of a button.

A solo group operates exactly like the global solo, signals outside the current routing are not affected.

21.5.3 Channel Layout - Layout Presets

To maintain overview within TotalMix FX channels can be hidden. Channels can also be excluded from being removed. Under *Options / Channel Layout* a dialog lists all I/Os with their current state. Selecting one or several channels enables the options to the right:

- **Hide Channel in Mixer/Matrix.** The selected channels are no longer shown in TotalMix FX, nor are they available via MIDI or OSC remote control.
- **Hide Channel in MIDI Remote 1-4.** The selected channels are hidden for MIDI remote (CC and Mackie Protocol).
- **Hide Channel in OSC Remote 1-4.** The selected channels are hidden for OSC remote control.

Hidden channels in Mixer/Matrix are still fully functional. An existing routing/mixing/FX processing stays active. But as the channel is no longer visible it can not be edited anymore. At the same time the hidden channels are removed from the list of remote controllable channels, to prevent them from being edited unnoticed.

Hidden channels in *MIDI Remote x* are removed from the list of remote controllable channels. Within an 8-channel block of a Mackie compatible control they are skipped. The control therefore is no longer bound to consecutive orders. For example it will control channels 1, 2, and 5 to 10, when channels 3 and 4 are hidden.

The same can be done for OSC. With unnecessary channels made invisible for the OSC remote the more important channels are available as one block on the remote.

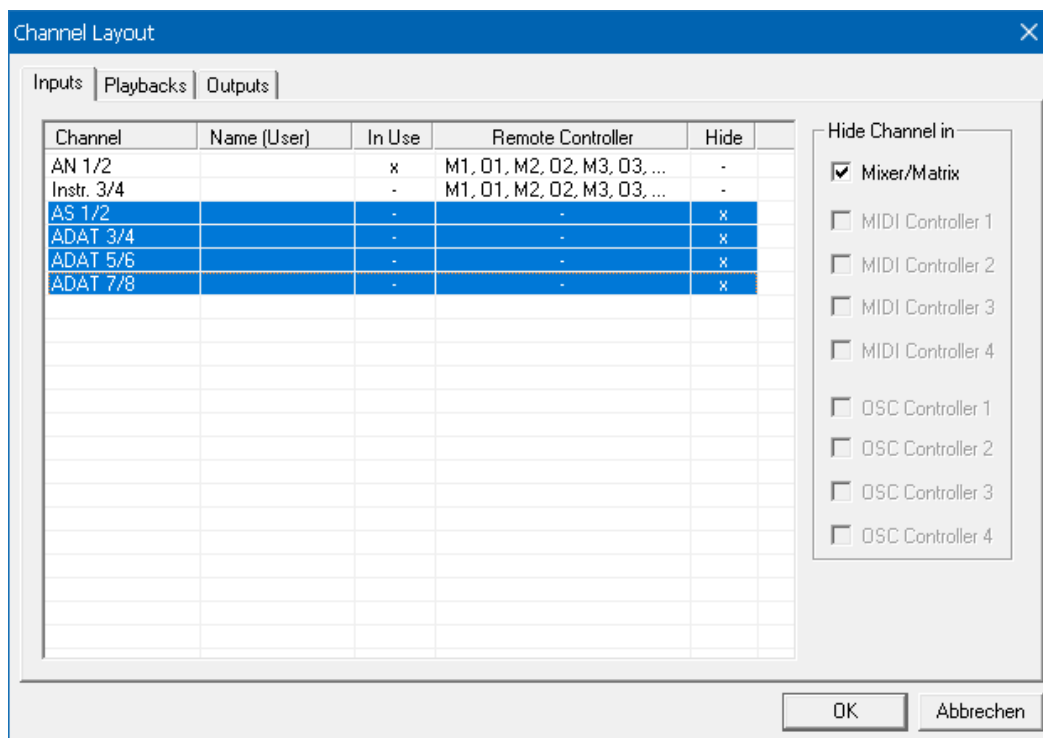

The dialog can be called directly from TotalMix by a right mouse click on any channel. The corresponding channel will then be preselected in the dialog.

In the above example ADAT channels have been made invisible. When ADAT is not used this is an easy way to remove them from the mixer completely.

Pages Inputs, Playbacks and Outputs are set up individually by the tabs at the top. A double click onto any line opens the edit field for the *Name (User)* column. Editing channel names in this dialog is quick, Enter jumps to the next line. The names of the channels in the Control Room section can only be changed this way.

After finishing those settings the whole state can be stored as **Layout Preset**. A click on *Store* and the desired memory slot makes the current channel layout recallable anytime. The button *All* makes all channels temporarily visible again.

With a simple click on a button it will then be possible to easily switch views of only the channels involved with the mixing of the drum section, the horn section, the violins, or any other useful view. An optimized remote layout can be activated here as well, with or without visible changes. Double-click the default slot name to enter any other name.



! *Layout Presets are stored within the Workspace, so make sure to save the current state before loading a different Workspace!*

The button *Sub* activates another useful special view. When in *Submix view*, *Sub* will cause all channels to disappear that are not part of the currently selected Submix/Hardware Output. *Sub* temporarily shows the mix based on all channels from Inputs and Playback row, independent from the current Layout Preset. That makes it very easy to see and to verify which channels are mixed/routed to the current output. *Sub* makes checking and verifying of mixes, but also the mix editing itself, a lot easier, and maintains perfect overview even with lots of channels.

21.5.4 Scroll Location Markers

Another feature to improve overview and working with TotalMix FX are scroll location markers (TotalMix view only). These are displayed automatically when the horizontal size of the TotalMix FX window is smaller than the channel display requires. Shown on the right side of the scrollbar of each row they have four elements:

- **Arrow to the left.** A left mouse click let the channels scroll to the very first one, or most left.
- **1.** Marker number 1. Scroll to the desired position and perform a right mouse click on 1. A dialog comes up with precise information. Once stored, a left mouse click will scroll the channels to the stored position.
- **2.** Marker number 2. See 1 for details.
- **Arrow to the right.** A left mouse click let the channels scroll the last one, or most right.



Scroll Location markers are stored in the Workspace.

Application Examples

While originally added to improve navigation in the HDSPe MADI FX (having 196 channels that never fit on any screen), the scroll location markers are also helpful with units having much less channels:

- When the TotalMix FX window is intentionally made small in width, so only a few channels are shown.
- When some or all EQ or Dynamics panels are open. Then all relevant settings are always visible, but require a lot of space horizontally.

21.6 Reverb and Echo

A click on FX in the *View Options - Show* brings up the Output FX panel. Here all parameters for the effects Reverb and Echo are adjusted.

The Babyface Pro uses a DSP engine within its FPGA for all the calculations of all the EQs and Low Cuts, in parallel to the TotalMix DSP mixing engine. However, Reverb and Echo are calculated on the host CPU - the computer. On current computers, this will not cause any noticeable CPU load.

The transmission of the stereo signal FX Send to the computer and the effects signal FX Out back to the Babyface Pro is done by two invisible ASIO channels. The delay (latency) generated by this method is of no consequence for the offered effects reverb and echo. But it is still taken into account for the adjustment of the Reverb PreDelay. The lowest value depends on the currently chosen buffer size (see Settings dialog, chapter 8.1).

Reverb. Activated by the On button.

Type. Lists different reverb types for selection. Available are:

- **Rooms Small, Medium, Large, Walls.** Room simulation of rooms in different size and behaviour.
- **Shorty** provides a short, rich and warm reverb.
- **Attack** slaps back.
- **Swagger** enriches and blows up the original sound source.
- **Old School** is just that.
- **Echoistic** has a heavy echo part within the reverb sound which brings some nice stereo effect as well.
- **8plus9** is a mixture of Old School and Echoistic.
- **Grand Wide** stands for a wide and open room and space.
- **Thicker** can be used as short reverb to enrich the original signal.
- **Space** has the most sizzle and longest reverb time.
- **Envelope.** Reverb effect where the volume course (envelope) is freely adjustable.
- **Gated.** Simpler version of the Envelope reverb for cut reverb effects.

Please note that all these reverb types are extremely flexible due to the available Smooth and Room Scale controls. Most of them can be used as short and long reverb, and sound totally different with Smooth turned to maximum or minimum.



TotalMix FX comes with factory presets and default values for all reverb types to ensure a fast setup time and quick results. Please take the time to experiment with them with different signals and different settings, to learn how different they can sound and can be used.

General Settings

PreDelay. Delay of the reverb signal. Adjustable from 0 ms up to 999 ms.

Low Cut. High-pass filter *before* the reverb generation, removes low frequency signals which should not cause a reverb sound. Adjustable from 20 Hz up to 500 Hz.

High Cut. Low-pass filter *after* the reverb generation. A reduction of the treble often lets the reverb sound more natural. Adjustable from 5 kHz up to 20 kHz.

Smooth. Softens the reverb effect, affects stereo width, density and sound colour. Adjustable from 0 up to 100.

Width. Adjusts the stereo width of the reverb signal from 100 (stereo) to 0 (mono).

Volume. Adjusts the level of the reverb effects signal sent to the FX return bus.

Special Settings for Room Types

Room Scale. Determines the size of the room, thus changing density and length of the reverb effect. Adjustable from 0.5 up to 3.0.

Special Settings for Envelope and Gated

Attack. Length of time for the volume increase of the reverb signal. Also called rise time. Adjustable from 5 ms up to 400 ms.

Hold. Length of time for the fixed volume part of the reverb signal. Adjustable from 5 ms up to 400 ms.

Release. Length of time for the volume decrease of the reverb signal. Adjustable from 5 ms up to 400 ms.

Special Settings for Space

Reverb Time. Sets the duration of the reverb referenced to a volume drop of 20 dB. Adjustable from 0.1 s up to 4.9 s.

High Damp. Sets the treble damping over time for the reverb signal. In principle, this is a low-pass filter like High Cut. Because of the operation principle of this reverb it shows a slightly different behaviour. Adjustable from 5 kHz up to 20 kHz.

Echo. Activated by the On button.

Type. Lists different echo algorithms for selection. Available are:

- **Stereo Echo.** Separated echo generators on left and right channel. As a result the echo follows the sound source within the stereo field.
- **Stereo Cross.** Echo generator on left and right channel with cross coupled feedback which is only working for the stereo parts of the input signal. In case the input signal is only left or right the Stereo Cross acts exactly like the Pong Echo.
- **Pong Echo.** Generates an echo that jumps between left and right channel, independent from the source signal's stereo position.

Settings

Delay Time. Sets the delay time for the first echo.

BPM. A double click on the lower value field offers a delay adjustment as *Beats Per Minute*.

Feedback. Feedback to produce further echoes.

Width. Adjusts the stereo width of the echo signal from 100 (stereo) to 0 (mono).

Volume. Adjusts the level of the echo effects signal sent to the FX return bus.

High Cut (HC). Option for more natural sound or intentional damping of the delayed signal.

Preset. Settings of the Reverb and the Echo can be stored, loaded, and copied between channels at any time. A click on Preset opens a menu with several entries:

- **Recall:** Presets stored before by the user can be selected and loaded
- **Save to:** There are 16 storage places available (Reverb/Echo Preset 1 to 16)
- **Import:** Loads a previously stored TM FX Reverb file (.tmrv) or a TM FX Echo file (.tmeo)
- **Export:** Stores the current state as TM FX Reverb file (.tmrv) or as TM FX Echo file (.tmeo)
- **Factory:** Includes 10 examples for the configuration of the Reverb
- **Reset:** Resets the Reverb or Echo
- **Rename:** The Presets 1 to 16 can be renamed. The changes will be shown in both lists Recall and Save to.

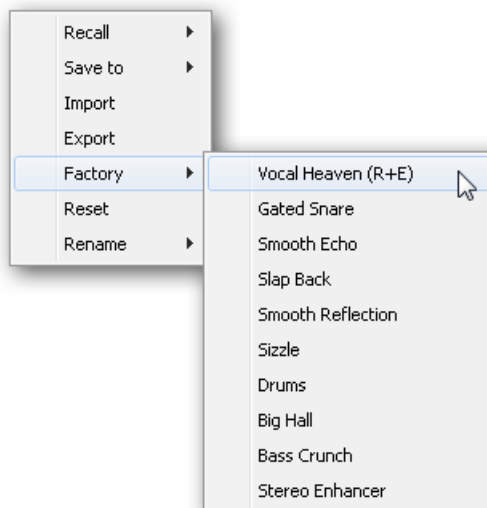

21.7 Preferences

The dialog Preferences can be opened via the *Options* menu or directly via F2.

Level Meters

- **Full scale samples for OVR.** Number of consecutive samples to trigger an over detection (1 to 10).
- **Peak Hold Time.** Hold time of the peak value. Adjustable from 0.1 up to 9.9 s.
- **RMS +3 dB.** Shifts the RMS value by +3 dB, so that full scale level is identical for Peak and RMS at 0 dBFS.

Mixer Views

- **FX Send follows highest Submix.** Locks the FX Send knob to the channel fader. As TotalMix supports multiple routings per channel, a definition is needed which fader (only one is visible) is the one that FX Send will follow. This is always the one with the highest fader position, means the highest gain.
- **FX Send follows Main Out mix.** Locks the FX Send knob to the channel fader only for the Main Out submix. This is a typical Live feature, where the FX Send is always tied to the fader for the most important output - the Main Out. When adjusting other submixes the FX send will not follow the fader movement.
- **Center Balance/Pan when changing Mono/Stereo.** When switching a stereo channel into two mono channels the panpots are set fully left and right. This option will set them to center instead.
- **Disable double click fader action.** Prevents unintentional gain settings, for example when using sensitive touchpads.
- **Disable mouse wheel operation.** Prevents unintentional changes when using the mouse wheel.
- **Store channel open/close in Layout Preset.** Also loads the state of the channel panels (Setting/EQ/Dyn).

Dynamic Meters

Not valid for the Babyface Pro.

Snapshots

- **Do not load - Main Volume, Main/Phones Volumes, Control Room Settings.** The selected values stored in the Snapshot are not loaded, so the current setting is not changed.

Device Handling

- **Always init...** and **Count MADI...** are not valid for the Babyface Pro.
- **Disable ASIO Direct Monitoring.** Disables ASIO Direct Monitoring (ADM) for the Babyface Pro within TotalMix FX.

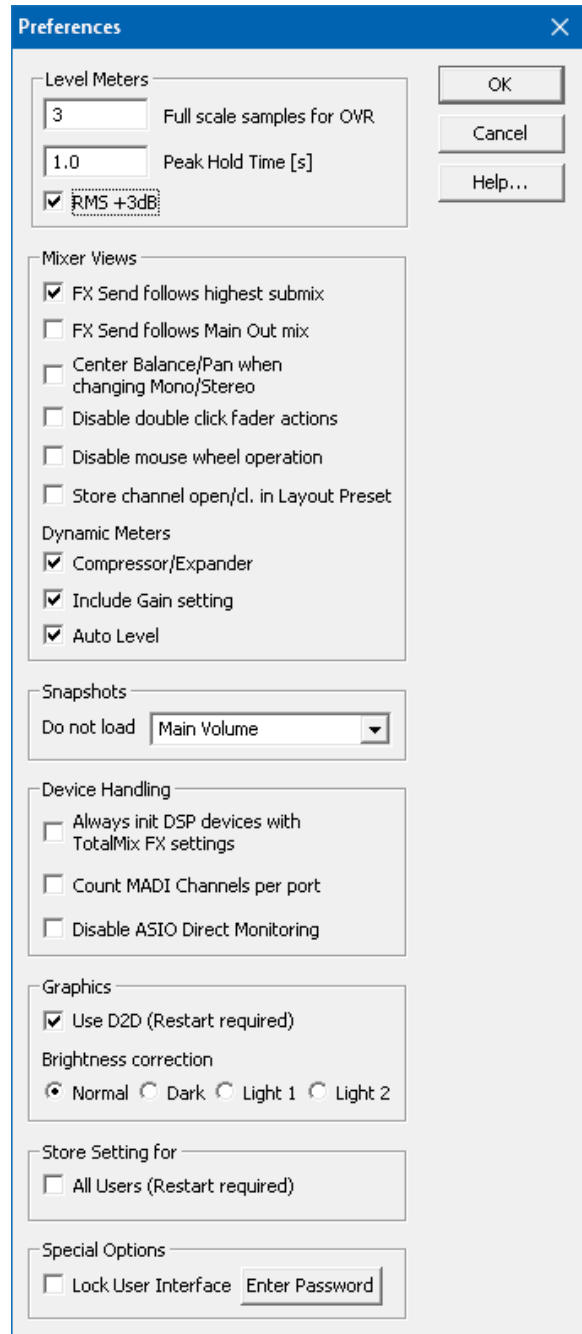

Graphics

- **Use D2D (Change requires restart).** Default on. Can be deactivated to use a compatible but CPU-taxing graphics mode, in case graphics problems show up.
- **Brightness correction.** Set TotalMix FX screen brightness to your taste, matching the monitor setting or the environment.

Store Setting for

- **All Users (Restart required).** See next chapter.

Special Options

- **Lock User Interface.** Default off. Can be activated to freeze the current mix state. Faders, buttons and knobs relating to the mix state cannot be moved anymore.
- **Enter Password (Windows only).** Secures the locked user interface with an additional password.

21.7.1 Store for Current or All Users

TotalMix FX stores all settings, workspaces and snapshots for the *current user* in:

XP: C:\Documents and Settings\Username\Local Settings\Application Data\TotalMixFX

Since Vista: C:\Users\Username\AppData\Local\TotalMixFX

Current User ensures that when workstations are used by several people they all find their own settings. In case the settings should be identical or given for any user, TotalMix FX can be changed to use the *All User* directory. An admin could even write protect the file **lastBabyface Pro1.xml**, which results in a complete reset to that file's content whenever TotalMix FX is restarted. The xml-file is updated on exit, so simply set up TotalMix as desired and exit it (right mouse click on the symbol in the notification area).

Paths under macOS X

Mac Current User: user/Library/Application Support/RME TotalMix FX

Mac All Users: /Library/Application Support/RME TotalMix FX

21.8 Settings

The dialog Settings can be opened via the *Options* menu or directly via F3.

21.8.1 Mixer Page

On the mixer page some typical settings for the mixer operation are set, like Talkback source, Dim amount when Talkback is active, the stored main volume or the input used for the External Input function.

Talkback

- **Input.** Selects the input channel of the Talkback signal (microphone in control room). Default: None.
- **Dim.** Amount of attenuation of the signals routed to the *Phones* in dB.

Listenback

- **Input.** Selects the input channel of the Listenback signal (microphone in recording room). Default: None.
- **Dim.** Amount of attenuation of the signals routed to the *Main Out* in dB.

Main Out

- **Recall.** User defined listening volume, activated by the Recall button at the unit or in TotalMix.
- **Dim.** Amount of attenuation for the Main Out in dB.
- **External Input.** Selects the stereo input that replaces the mix signal on the Main Out when activated. The volume of the stereo signal is adjusted by the slider Gain.

Solo/PFL Mode

- **Live Mode, PFL replaces Solo.** PFL means Pre Fader Listening. This feature is very useful when operating TotalMix in a live environment, as it allows to quickly listen/monitor any of the inputs by hitting the Solo button. Monitoring happens on the output set for the Cue signal via the Assign dialog.
- **Exclusive Solo/PFL Mode.** Only a single Solo or PFL can be active at a time. Activating a different one automatically deactivates the previous one.
- **2-Row Mode with only Input in first row.** The Software Playback channels are shifted to the lower row, beside the Hardware Outputs.

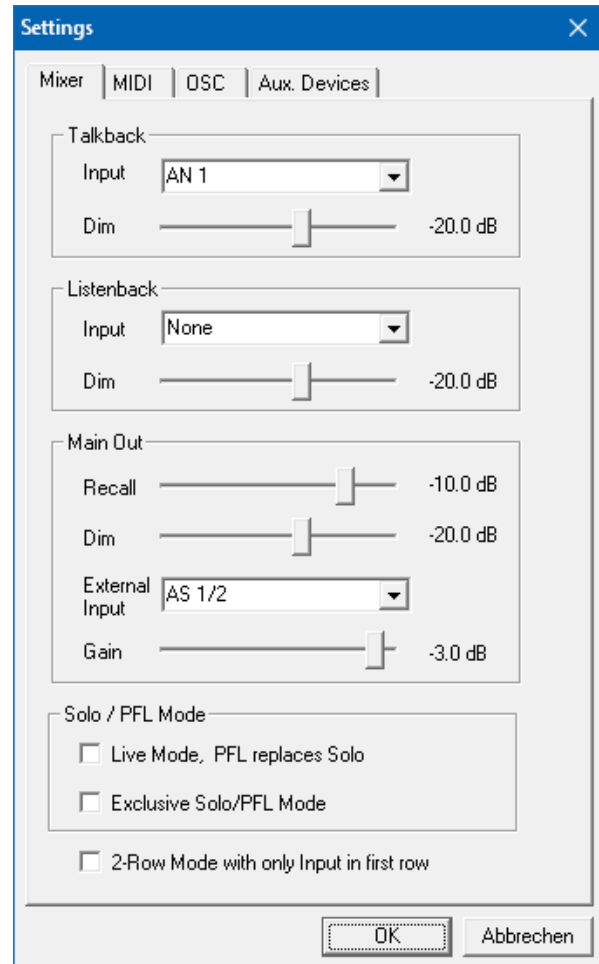

21.8.2 MIDI Page

The MIDI page has four independent settings for up to four MIDI remote controls, using CC commands or the Mackie Control protocol.

Index

Select one of four settings pages and thus remote controls. Settings are remembered automatically. To activate or deactivate any of the four remote controls check or uncheck 'In Use'.

MIDI Remote Control

- **MIDI In.** Input where TotalMix receives MIDI Remote data.
- **MIDI Out.** Output where TotalMix sends MIDI Remote data.
- **Disable MIDI in background.** Deactivates MIDI Remote Control as soon as another application is in the focus, or when TotalMix has been minimized.

Mackie Control Options

- **Enable Protocol Support.** When disabled TM FX will only react on the Control Change commands of chapter 24.5.
- **Extender to.** Sets the current remote to be an extender to the main remote. Both remotes will be shown as one block and navigate simultaneously.
- **Map Stereo to 2 Mono Channels.** One fader controls one (mono) channel. Should be disabled when stereo channels are used.
- **Submix Selection in Input/Playback Row.** Enables a selection of the submix when in first row, without having to change to the third row first. However, when using both mono and stereo channels first and third row usually do not match anymore, so the selection often becomes unclear this way.
- **Enable full LCD support.** Activates full Mackie Control LCD support with eight channel names and eight volume/pan values.
- **Send User defined Names.** Channel names defined by the user will be sent to the remote device via MIDI and – if supported – shown in its display.
- **Send Level Messages.** Activates the transmission of the level meter data. *Peak Hold* activates the peak hold function as set up for the TotalMix level meters in the preferences.

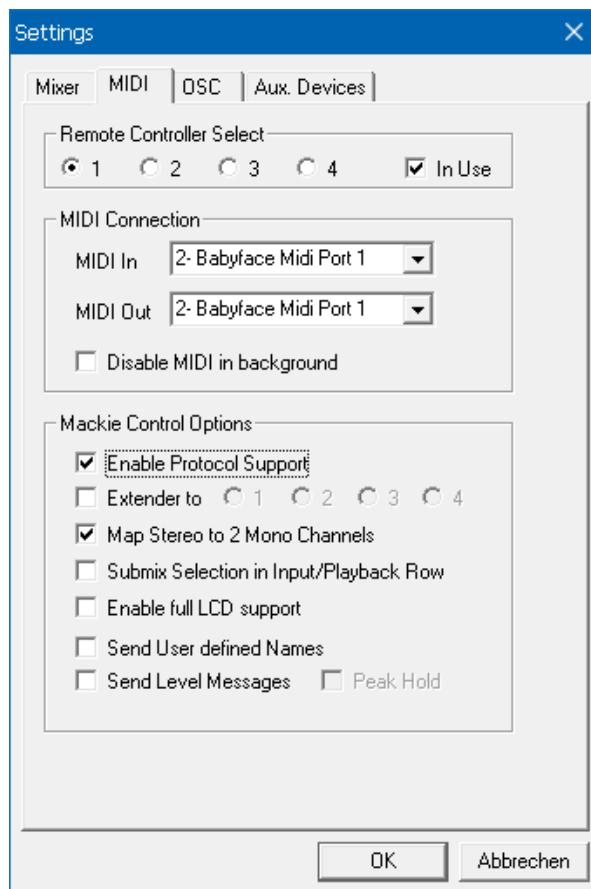

Note: When MIDI Out is set to NONE then TotalMix FX can still be controlled by Mackie Control MIDI commands, but the 8-channel block is not marked as remote target.

21.8.3 OSC Page

The OSC page has four independent settings for up to four MIDI remote controls via Open Sound Control (OSC). This is a network based remote protocol that can be used for example by Apple's iPad with the app *TouchOSC* or *Lemur* to wirelessly remote control TotalMix FX running on a Mac or Windows computer.

Index

Select one of four settings pages and thus remote controls. Settings are remembered automatically. To activate or deactivate any of the four remote controls check or uncheck 'In Use'.

TotalMix FX OSC Service

- **IP.** Shows the network address of the computer running TotalMix FX (local host). This address must be entered on the remote side.
- **Host Name.** Local computer name.
- **Port incoming.** Must match the remote entry 'Port outgoing'. Typical values are 7001 or 8000.
- **Port outgoing.** Must match the remote entry 'Port incoming'. Typical values are 9001 or 9000.

Remote Control

- **IP or Host name.** Enter the IP or host name of the remote control. Please note that the IP number usually works better than the host name.

Options

- **Send Peak Level.** Activates the transmission of the peak level meter data. *Peak Hold* activates the peak hold function as set up for the TotalMix level meters in the preferences.
- **Lock Remote to submix.** When activated the current remote control can only modify the submix selected from the drop-down list. This prevents havoc in multi-remote monitoring environments.
- **Number of faders per bank.** Available choices are 8 (default), 12, 16, 24, 32 and 48. Note that when working in underperforming networks, especially wireless, a higher number of faders might not work as smooth as expected.

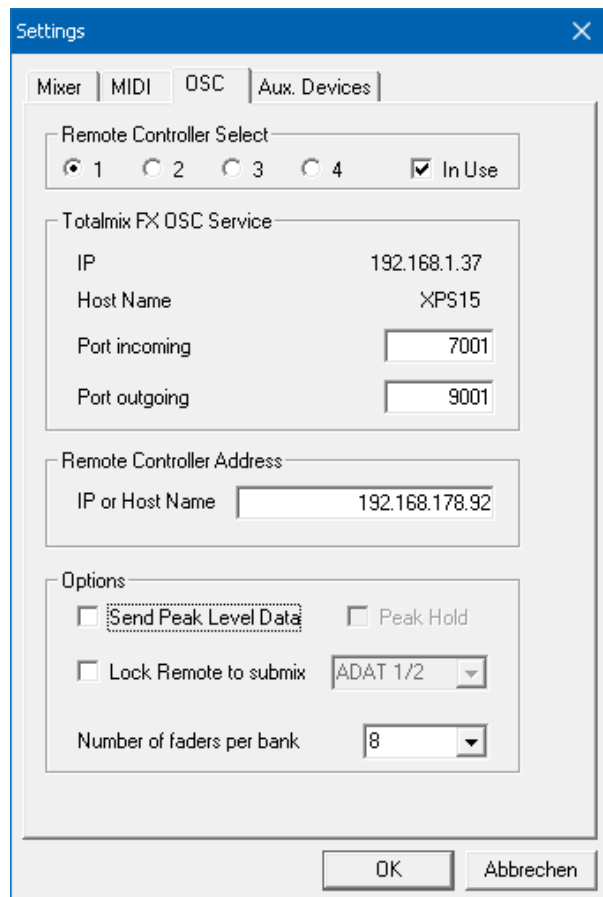

21.8.4 Aux Devices

The RME OctaMic XTC is a highly flexible hi-quality 8-channel microphone, line and instrument preamp with integrated AD-conversion to ADAT, AES/EBU and MADI, plus 4 channels of DA-conversion for monitoring. It can be used as universal front-end for the Babyface Pro and other interfaces.

To simplify operation the most important parameters of the XTC (gain, 48V, Inst/PAD, AutoSet) can be controlled directly from the TotalMix FX input channels. This special remote control uses MIDI of any format (DIN, USB, MIDI over MADI).

Device Settings

- **Digital Channels.** Select where the OctaMic XTC sends its 8 analog channels to. With the Babyface Pro this will be the ADAT channels 1-8.
- **Device.** At this time only the OctaMic XTC is supported and can be chosen.

MIDI Settings

- **MIDI In.** Set the currently used MIDI connection to OctaMic XTC.
- **MIDI Out.** Set the currently used MIDI connection to OctaMic XTC.
- **Device ID.** Default 0. This setting relates to the current choice in Digital Channels.

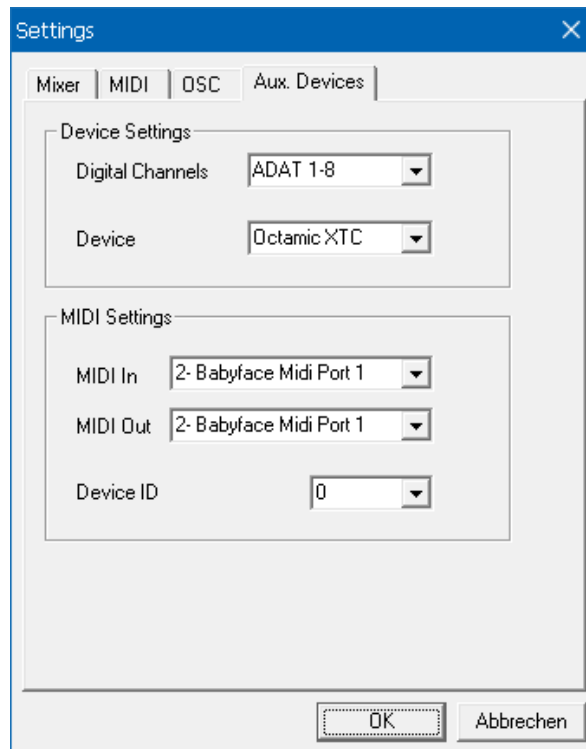

The screenshot to the right shows what happens as soon as the above settings have been confirmed with OK. The ADAT channels show new elements for phantom power, Inst/PAD, Gain and AutoSet. Control operates bidirectional, so changing the gain at the unit will be mirrored in the TotalMix channels. Changing the gain in TotalMix FX will set the gain in the unit, which is also shown on the unit's display.

For the remote to work the XTC's currently used MIDI I/Os have to be set to *Control*. More details are found in the manual of the OctaMic XTC.



21.9 Hotkeys and Usage

TotalMix FX has many hotkeys and mouse/hotkey combinations to speed up and simplify the usage. The below description refers to Windows. On Mac substitute *Ctrl* in the below list with the command key (⌘).

The **Shift** key enables a fine-tuning of the gain with all faders and in the Matrix. On all knobs it will speed up the setting.

A click on a **fader** with held down **Shift** key adds the fader to the temporary fader group.

A click in the **fader path** with held down **Ctrl** key will let the fader jump to 0 dB, at the next click to $-\infty$. Same function: Double click of the mouse.

Clicking on one of the **Panorama** or **Gain** knobs with held down **Ctrl** key lets the knob jump to center position. Same function: Double click of the mouse.

Clicking on the **Panorama** knob with held down **Shift** key lets the knob jump to fully left, with **Shift-Ctrl** to fully right.

Clicking on one of the channel settings buttons (slim/normal, settings, EQ) with held down **Ctrl** key lets all channels to the right change their state. For example all panels can be opened/closed simultaneously.

A **double click** of the mouse on a knob or its numerical field opens the according *Input Value* dialog. The desired value can then be set by keyboard.

Dragging the mouse from a parameter field increases (move up) or decreases (move down) the value in the field.

Ctrl-N opens the dialog *Function Select* to open a new TotalMix window.

Ctrl-W opens the dialog *File Open* of the operating system to load a TotalMix Workspace file.

The key **W** starts the dialog *Workspace Quick Select* for a direct selection or storage of up to 30 Workspaces.

The key **M** switches the active window to Mixer view. The key **X** switches the active window to Matrix view. **Ctrl-M** opens a new Mixer window, **Ctrl-X** opens a new Matrix window. Another **Ctrl-M** or **Ctrl-X** closes the new window again.

F1 opens the online help. The Level Meter setup dialog can be opened with **F2** (same as in DIGICheck). The dialog Preferences is opened with **F3**.

Alt-F4 closes the current window.

Alt and **number** keys 1 to 8 (not on the numeric keypad!) will load the corresponding Workspace from the Workspace Quick Select feature (hotkey W).

21.10 Menu Options

Deactivate Screensaver: When active (checked) any activated Windows screensaver will be disabled temporarily.

Always on Top: When active (checked) the TotalMix window will always be on top of the Windows desktop.

Note: This function may result in problems with windows containing help text, as the TotalMix window will even be on top of those windows, so the help text isn't readable.

Enable MIDI / OSC Control: Activates external MIDI control of the TotalMix mixer. In Mackie Protocol mode the channels which are currently under MIDI control are indicated by a colour change of the name field.

Submix linked to MIDI / OSC control (1-4). The 8-channel group follows the currently selected submix, means Hardware Output, when a different submix is chosen on the remote as well as when doing this in TotalMix. When using multiple windows it can be useful to deactivate this feature for specific windows. The view will not change then.

Preferences: Opens a dialog to configure several functions of the level meters and the mixer. See chapter 21.7.

Settings. Opens a dialog to configure several functions like Talkback, Listenback, Main Out and MIDI Remote Control. See chapter 21.8.

Channel Layout. Opens a dialog to hide channels visually and from remote. See chapter 21.5.

ARC & Key Commands. Opens a window to configure the computer's keyboard keys F4 to F8, the ARC USB buttons, and the buttons A, B, OUT, SET and DIM of the Babyface Pro.

Reset Mix. Offers several options to reset the mixer state:

- **Straight playback with all to Main Out.** All Playback channels are routed 1:1 to the Hardware Outputs. Simultaneously all playbacks are mixed down to the Main Out. The faders in the third row are not changed.
- **Straight Playback.** All Playback channels are routed 1:1 to the Hardware outputs. The faders in the third row are not changed.
- **Clear all submixes.** Deletes all submixes.
- **Clear channel effects.** Switches off all EQs, Low Cuts, Reverb, Echo and Stereo Width and sets their knobs to default position.
- **Set output volumes.** All third row faders will be set to 0 dB, Main and Speaker B to -10 dB.
- **Reset channel names.** Removes all names assigned by the user.
- **Set all channels mono.** Reconfigures all TotalMix FX channels to mono mode.
- **Set all channels stereo.** Reconfigures all TotalMix FX channels to stereo mode.
- **Set inputs mono / outputs stereo (ADM).** Preferred setup for best ASIO Direct Monitoring compatibility. In most cases mono hardware outputs will break ADM. Mono inputs are in most cases compatible. If not wrong panning might occur.

- **Total Reset.** Playback routing 1:1 with mixdown to Main Out. Switches off all other functions.

Operational Mode. Defines TotalMix FX basic operational mode. Choices are *Full Mode* (default, mixer active, all routing options available), and *Digital Audio Workstation Mode* (straight playback routing, no input mix). See chapter 25 for details.

Network Remote Settings. Settings to remote control TotalMix FX by TotalMix Remote via network. See chapter 26.

21.11 Menu Window

Zoom Options 100%, 135%, 200%, 270%. Depending on size of the monitor and its resolution TotalMix FX might be too small and the controls too tiny to easily operate them. Together with the 2 Row mode these options allow for different display sizes that suit all monitors.

Hide Control Strip. Shifts the Control Strip out of the visible area to gain more space for other elements.

22. The Matrix

22.1 Overview

The mixer window of TotalMix looks and operates similar to mixing desks, it is stereo-based. The matrix display presents a different method of assigning and routing channels, based on a single channel or monaural design. The matrix view has the look and works like a conventional patchbay, adding functionality way beyond. While most patchbays will allow you to connect inputs to outputs with just the original level (1:1, or 0 dB, as known from mechanical patchbays), TotalMix allows you to use a freely definable gain value per crosspoint.

Matrix and TotalMix are different ways of displaying the same processes. Because of this both views are always fully synchronized. Each change in one view is immediately reflected in the other view as well.

22.2 Elements of the Matrix View

The Matrix' visual design is mainly determined by the architecture of the Babyface Pro system:

- **Horizontal labels.** All hardware outputs
- **Vertical labels.** All hardware inputs. Below are all playback channels.
- **Green 0.0 dB field.** Standard 1:1 routing
- **Blue field.** This routing is muted
- **Red field.** Phase 180° (inverted)
- **Dark grey field.** No routing.
- **Dark grey field with number.** Shows the current gain value as dB

	Out 1	Out 2	Out 3	Out 4	Out 5
AN 1/2	0.0	-5.8			
INST 3			0.0		
INST 4				-18.5	
AS 1/2					
ADAT 3/4					
ADAT 5/6					

To maintain overview when the window size has been reduced, the labels are floating. They won't leave the visible area when scrolling. A right mouse click on the labels brings up the context menu with the exact same options as in the mixer view: Copy / Mirror / Paste / Clear input channels, submixes and FX settings.

22.3 Operation

Using the Matrix is a breeze. It is very easy to identify the current crosspoint, because the outer labels light up in orange according to the mouse position.

- If input 1 is to be routed to output 1, use the mouse and click one time on crosspoint **In 1 / AN 1** with held down Ctrl key. Two green 0.0 dB field pop in, another click removes them.
- To change the gain (equals the use of a different fader position, see simultaneous display of the mixer view), drag the mouse up or down, starting from the gain field. The value within the field changes accordingly. The corresponding fader in the mixer view is moving simultaneously, in case the currently modified routing is visible.
- On the right side is the Control Strip from the mixer window, adapted to the Matrix. The button for the temporary fader group is missing as well as all View options, as they don't make sense here. Instead the button *Mono Mode* lets you decide whether all the actions performed in the Matrix are valid for two channels or just one.

The Matrix not always replaces the mixer view, but it significantly enhances the routing capabilities and - more important - is a brilliant way to get a fast overview of all active routings. It shows you in a glance what's going on. And since the Matrix can operate monaural, it is very easy to set up specific routings with specific gains.

23. Tips and Tricks

23.1 ASIO Direct Monitoring (Windows)

Programs that support ADM (ASIO Direct Monitoring - Samplitude, Sequoia, Cubase, Nuendo etc.) send control commands to TotalMix. This is directly shown by TotalMix. When a fader is moved in the ASIO host the corresponding fader in TotalMix will move too. TotalMix reflects all ADM gain and pan changes in real-time.

But: the faders only move when the currently activated routing (the selected submix) corresponds to the routing in the ASIO host. The Matrix on the other hand will show any change, as it shows all possible routings in one view. For best ADM compatibility use mono inputs and stereo outputs. This setup can be activated globally under Options, Reset Mix.

23.2 Copy a Submix

TotalMix allows you to copy complete submixes to other outputs. In case a complex submix is needed with only a few changes on a different output, the whole submix can be copied to that output. Right click with the mouse on the original submix output (Hardware Output). In the context menu select Copy Submix. Then right click on the new submix output, choose Paste Submix in the context menu. Now fine tune the submix.

23.3 Doubling the Output Signal (Mirror)

If a mix should be sent out via two (or more) different hardware outputs simply mirror that mix to any number of other outputs. A right click on the original output brings up the option to *Copy/Mirror <name>*. Another right click on the new output, then selecting *Mirror of Output <name>* will paste the whole submix and then synchronize it automatically to any future changes. The outputs now always send out the same signals, but their main volume (fader) and the EQ and Dynamics settings stay fully independent.

23.4 Delete a Submix

The easiest and quickest way to delete complex routings is by selection of the according output channel in the mixer view by a right mouse click, and selection of *Clear Submix*. As TotalMix FX includes an unlimited undo the delete process can be undone without any problem.

23.5 Copy and Paste everywhere

The above three tips use functions found in the right click context menu available on all channels of the TotalMix FX mixer view. These menus are also available in the Matrix, but only directly on the channel labels. They are self-explanatory and automatically adjust to where the click is performed. The input channels offer *Clear*, *Copy input*, *Paste the input mix* and *Paste its FX*. On a playback channel *Copy*, *Paste* and *Clear the playback mix* are available. On an output channel *Copy* and *Mirror* functionality for the current submix and *copying* of the FX settings is offered.

These options are very advanced and mighty tools to quickly do the impossible. Still there is no need to fear breaking something, as a simple click (or several) on the Undo button will get you back to where you started!

23.6 Recording a Submix - Loopback

TotalMix includes an internal loopback function, from the Hardware Outputs to the recording software. Instead of the signal at the hardware input, the signal at the hardware output is sent to the record software. This way, submixes can be recorded without an external loopback cable. Also the playback from a software can be recorded by another software.

The function is activated by the **Loopback** button in the Settings panel of the Hardware Outputs. In loopback mode, the signal at the hardware input of the corresponding channel is no longer sent to the recording software, but still passed through to TotalMix. Therefore TotalMix can be used to route this input signal to any hardware output. Using the subgroup recording, the input can still be recorded on a different channel.

As each of the 6 stereo hardware outputs can be routed to the record software, and none of these hardware inputs get lost, TotalMix offers an overall flexibility and performance not rivalled by any other solution.

The risk of feedbacks, a basic problem of loopback methods, is low, because the feedback can not happen within the mixer, only when the audio software is switched into monitoring mode.

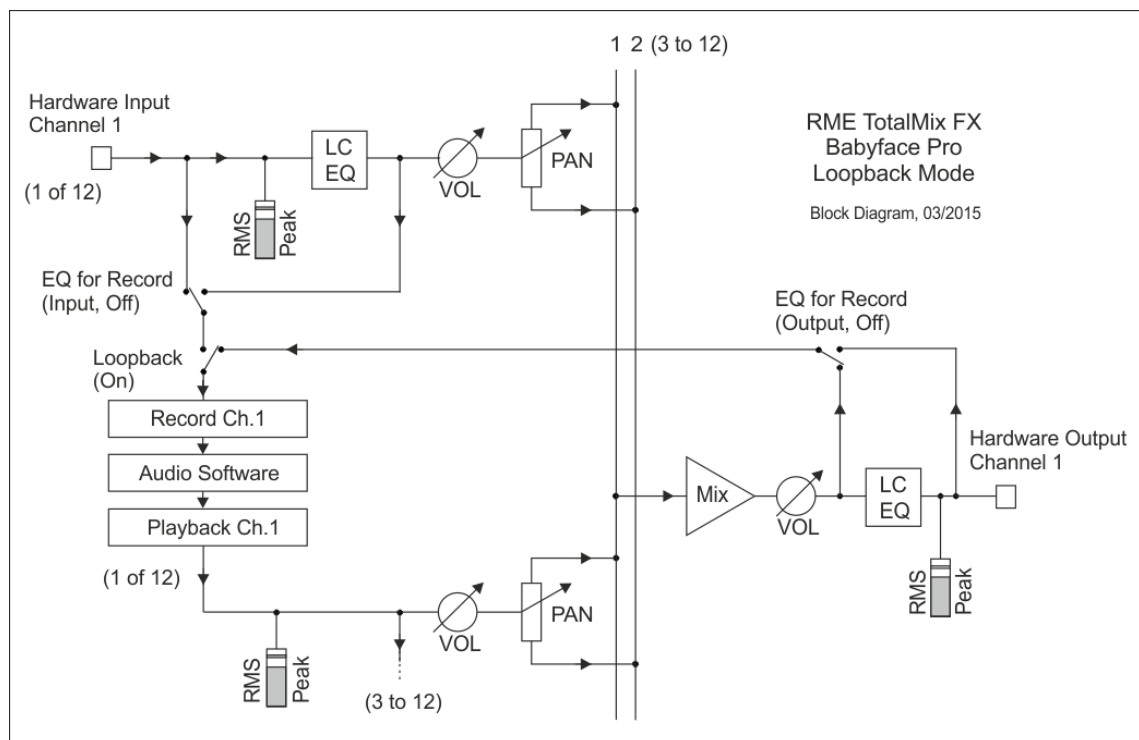

The block diagram shows how the software's input signal is played back, and fed back from the Hardware Output to the software input.

The block diagram also shows why with activated Loopback the EQ of the Hardware Output is now within the record path. The setting *DSP – EQ for Record* is still working and can be used to activate/deactivate LC/EQ here as well.

Recording a Software's playback

In real world application, recording a software's output with another software will show the following problem: The record software tries to open the same playback channel as the playback software (already active), or the playback one has already opened the input channel which should be used by the record software.

This problem can easily be solved. First make sure that all rules for proper multi-client operation are met (not using the same record/playback channels in both programs). Then route the playback signal via TotalMix to a hardware output in the range of the record software, and activate Loopback for recording.

Mixing several input signals into one record channel

In some cases it is useful to record several sources into only one track. For example when using two microphones recording instruments and loudspeakers, TotalMix' Loopback mode saves an external mixing desk. Simply route/mix the input signals to the same output (third row), then redefine this output into a record channel via Loopback. This way any number of input channels from different sources can be recorded into one single track.

23.7 MS Processing

The mid/side principle is a special positioning technique for microphones, which results in a mid signal on one channel and a side signal on the other channel. These information can be transformed back into a stereo signal quite easily. The process sends the monaural mid channel to left and right, the side channel too, but phase inverted (180°) to the right channel. Note: the mid channel represents the function L+R, while the side channel represents L-R.

During record the monitoring needs to be done in 'conventional' stereo. Therefore TotalMix also offers the functionality of a M/S-decoder. Activation is done in the Settings panel of the Hardware Input and Software Playback channels via the **MS Proc** button.

The M/S-Processing automatically operates as M/S encoder or decoder, depending on the source signal format. When processing a usual stereo signal, all monaural information will be shifted into the left channel, all stereo information into the right channel. Thus the stereo signal is M/S encoded. This yields some interesting insights into the mono/stereo contents of modern music productions. Additionally some very interesting methods of manipulating the stereo base and generating stereo effects come up, as it is then very easy to process the side channel with Low Cut, Expander, Compressor or Delay.

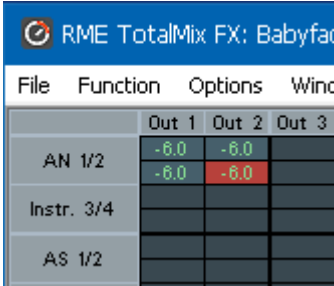

	Out 1	Out 2	Out 3
AN 1/2	-6.0	-6.0	
Instr. 3/4	-6.0	-6.0	
AS 1/2			

The most basic application is the manipulation of the stereo width: a change of the level of the side channel allows to manipulate the stereo width from mono to stereo up to extended.

23.8 Program start options (Windows only)

Under Windows TotalMix FX supports command line options. Appending the file name of a workspace loads it. Example: *TotalMixFX.exe path\startworkspace.tmws*. For automated loading, the parameter */nc* can be used to suppress the confirmation dialog of loading the workspace.

24. MIDI Remote Control

24.1 Overview

TotalMix can be remote controlled via MIDI. It is compatible to the widely spread Mackie Control protocol, so TotalMix can be controlled with all hardware controllers supporting this standard. Examples are the Mackie Control, Tascam US-2400 or Behringer BCF 2000.

Additionally, the stereo output faders (lowest row) which are set up as *Main Out* in the Control Room section can also be controlled by the standard **Control Change Volume** via **MIDI channel 1**. With this, the main volume of the Babyface Pro is controllable from nearly any MIDI equipped hardware device.

MIDI Remote Control always operates in View *Submix* mode, even when the View Option *Free* is currently selected in TotalMix FX.

24.2 Mapping

TotalMix supports the following Mackie Control surface elements*:

Element:	Meaning in TotalMix:
Channel faders 1 – 8	volume
Master fader	Main Monitor channel's faders
V-Pots 1 – 8	pan
pressing V-Pot knobs	pan = center
CHANNEL LEFT or REWIND	move one channel left
CHANNEL RIGHT or FAST FORWARD	move one channel right
BANK LEFT or ARROW LEFT	move eight channels left
BANK RIGHT or ARROW RIGHT	move eight channels right
ARROW UP or Assignable1/PAGE+	move one row up
ARROW DOWN or Assignable2/PAGE-	move one row down
EQ	Master Mute
PLUGINS/INSERT	Master Solo
STOP	Dim Main Out
PLAY	Talkback
PAN	Mono Main Out
FLIP	Speaker B
DYN/INSTRUMENT	TrimGains
MUTE Ch. 1 – 8	Mute
SOLO Ch. 1 – 8	Solo
SELECT Ch. 1 – 8	Select
REC Ch. 1 – 8	select output bus (Submix)
RECORD	Recall
F1 - F8	load Snapshot 1 - 8
F9	select Main Out
F10 - F11	select Cue Phones 1 - 2

*Tested with Behringer BCF2000 Firmware v1.07 in Mackie Control emulation for Steinberg mode and with Mackie Control under Mac OS X.

24.3 Setup

Open the Preferences dialog (menu Options or F3). Select the MIDI Input and MIDI Output port where your controller is connected to.

When no feedback is needed select NONE as MIDI Output.

Check *Enable MIDI Control* in the Options menu.

24.4 Operation

The channels being under Mackie MIDI control are indicated by a colour change of the name field, black turns to brown.

The 8-fader block can be moved horizontally and vertically, in steps of one or eight channels.

In Submix View mode, the current routing destination (output bus) can be selected via REC Ch. 1 – 8. This equals the selection of a different output channel in the lowest row by a mouse click when in Submix View. In MIDI operation it is not necessary to jump to the lowest row to perform this selection. This way even the routing can be easily changed via MIDI.

Full LC Display Support. This option in Preferences (F3) activates complete Mackie Control LCD support with eight channel names and eight volume/pan values. When *Full LC Display Support* is turned off, a brief information about the first fader of the block (channel and row) is sent. This brief information is also available on the LED display of the Behringer BCF2000.

Disable MIDI in Background (menu Options, Settings) disables the MIDI control as soon as another application is in the focus, or in case TotalMix has been minimized. This way the hardware controller will control the main DAW application only, except when TotalMix is in the foreground. Often the DAW application can be set to become inactive in background too, so that MIDI control is switched between TotalMix and the application automatically when switching between both applications.

TotalMix also supports the 9th fader of the Mackie Control. This fader (labelled Master) will control the stereo output fader (lowest row) which is set up as *Main Out* in the Control Room section.

Extender support (Settings, tab MIDI) enables the use of the special Extender mixing desk, but also the addition of any other Mackie compatible remote. Setting the main remote as number 2 and the extender as number 1 will cause the extender to be on the left side. Using this function the remotes will be shown as one fader block and navigate as one.

24.5 MIDI Control

The hardware output set up as *Main Out* can be controlled by the standard **Control Change Volume** via **MIDI channel 1**. With this, the main volume of the Babyface Pro is controllable from nearly any MIDI equipped hardware device.

Even if you don't want to control all faders and pans, some buttons are highly desirable to be available in 'hardware'. These are mainly the *Talkback* and the *Dim* button, and the monitoring options (listen to Phones submixes). Fortunately a Mackie Control compatible controller is not required to control these buttons, as they are steered by simple Note On/Off commands on MIDI channel 1.

The notes are (hex / decimal / keys):

Dim: 5D / 93 / **A 6**

Mono: 2A / 42 / **#F 2**

Talkback: 5E / 94 / **#A 6**

Recall: 5F / 95 / **H 6**

Speaker B: 32 / 50 / **D3**

Cue Main Out: 3E / 62 / **D 4**

Cue Phones 1: 3F / 63 / **#D 4**

Cue Phones 2: 40 / 64 / **E 4**

Snapshot 1: 36 / 54 / **#F 3**

Snapshot 2: 37 / 55 / **G 3**

Snapshot 3: 38 / 56 / **#G 3**

Snapshot 4: 39 / 57 / **A 3**

Snapshot 5: 3A / 58 / **#A 3**

Snapshot 6: 3B / 59 / **B 3**

Snapshot 7: 3C / 60 / **C 4**

Snapshot 8: 3D / 61 / **#C 4**

Trim Gains: 2D / 45 / **A 2**

Master Mute: 2C / 44 / **#G2**

Master Solo: 2B / 43 / **G2**

Furthermore all faders of all three rows can be controlled via simple **Control Change** commands. The format for the Control Change commands is:

Bx yy zz

x = MIDI channel

yy = control number

zz = value

The first row in TotalMix is addressed by MIDI channels 1 up to 4, the middle row by channels 5 up to 8 and the bottom row by channels 9 up to 12.

16 Controller numbers are used: 102 up to 117 (= hex 66 to 75). With these 16 Controllers (= faders) and 4 MIDI channels each per row, up to 64 faders can be controlled per row (as required by the HDSPe MADI).

Examples for sending MIDI strings:

- Set input 1 to 0 dB: B0 66 68
- Set input 5 to maximum attenuation: B1 6A 0
- Set playback 1 to maximum: B4 66 7F
- Set Output 3 to 0 dB: B8 68 68

Note: Sending MIDI strings requires the use of programmer's logic for the MIDI channel, starting with 0 for channel 1 and ending with 15 for channel 16.

Further functions:

- Trim Gains On: BC 66 xx (BC = MIDI channel 13, xx = any value)
- Trim Gains Off: BC 66 xx or select a submix

Select submix (fader) in third row:

- channel 1/2: BC 68/69 xx
 - channel 3/4: BC 6A/6B xx
- etc.

Input Gain control is available via CC9, value range as the gain itself (up to 65). The MIDI channel determines the controlled channel, from 1 to 16 (Babyface Pro: only 1/2/3/4). For this to work, *Enable MIDI Control* in the Options menu has to be activated.

The **Reverb** and **Echo User Presets** can be changed via MIDI CC: B2 0C nn for Reverb preset 1 to 16, B3 0C nn for Echo preset 1 to 16

24.6 Loopback Detection

The Mackie Control protocol requires feedback of the received commands, back to the hardware controller. So usually TotalMix will be set up with both a MIDI input and MIDI output. Unfortunately any small error in wiring and setup will cause a MIDI feedback loop here, which then completely blocks the computer (the CPU).

To prevent the computer from freezing, TotalMix sends a special MIDI note every 0.5 seconds to its MIDI output. As soon as it detects this special note at the input, the MIDI functionality is disabled. After fixing the loopback, check *Enable MIDI Control* under Options to reactivate the TotalMix MIDI.

24.7 OSC (Open Sound Control)

Besides simple MIDI notes, the Mackie Protocol and Control Change commands, TotalMix FX can also be controlled by the Open Sound Control, OSC. For details on setup and usage see chapter 21.8.3.

An OSC implementation chart can be downloaded from the RME website:

http://www.rme-audio.de/downloads/osc_table_totalmix.zip

RME offers a free iPad template for the iOS app TouchOSC (by Hexler, available in the Apple App-Store):

http://www.rme-audio.de/downloads/tosc_tm_ipad_template.zip

The RME forum hosts further information, more templates (iPhone...) and lots of useful user feedback.

25. DAW Mode

Users that work exclusively with their DAW software, and don't want to use TotalMix FX for additional routing tasks, need a way to be sure that TotalMix FX currently doesn't change the DAW's routing. While *Reset Mix* can do so, those users would be better served with a very simple surface that offers the interface's hardware controls (gain, phantom control, instrument...), but guarantees a straight 1:1 routing for all playback channels, and has no hardware monitoring of the input channels (which is then done by the DAW software).

For such cases TotalMix FX includes an alternative operating mode. It can be booted into the so called *DAW mode*. This simplified interface is for anyone performing all monitoring and routing within the DAW. The DAW mode restarts TM FX into a light version with just two rows, no playback row, and no mixing faders in the input row. Routing is 1:1 only. Just the hardware controls (if existing) and hardware output levels are available.

To change the current mode go to the menu, Options, and click on *Operational Mode*. Choices are *Full Mode* (default, mixer active, all routing options available), and *Digital Audio Workstation Mode* (straight playback routing, no input mix).

Several useful, advanced features are still available in TotalMix FX in DAW mode:

- Talkback, External Input
- Phones definition and handling with Talkback
- Speaker A / B
- Mute and Solo
- Cue / PFL

26. TotalMix Remote

TotalMix Remote is a remote control for TotalMix FX v1.50 and up, to control the hardware mixer and effects in RME audio interfaces. TotalMix Remote mirrors the current state of the host system on the iPad and Windows/Mac computers - the entire mixing state, the complete routing, all FX settings, up to the level meters, and everything in real-time. TotalMix Remote supports up to three hosts with multiple interfaces each, allowing Apple's popular iPad and Windows/Mac computers to adjust all the mixer and FX settings from a distance, via Ethernet and WiFi.

Supported Hardware

TotalMix Remote communicates with TotalMix FX 1.50 or up. Any RME hardware that can be used with TotalMix FX is supported automatically.

Quick Start

On the host (the computer with the connected audio interface) go to the TotalMix FX menu *Options, Network Remote Settings*. Click *Enable TotalMix Remote Server* to start this service. Under Windows a Firewall warning will come up. Allow TotalMix FX or it won't work. This dialog also shows the host's IP, like 192.168.1.45.

Make sure both host and remote computer / iPad reside in the same network. Start TotalMix Remote on the remote computer / iPad (not on the host!). On the iPad, tap on the gear symbol in the upper right corner, then on *Host Connection Settings*. On Windows / Mac either the dialog comes up automatically or can be called from the *Search Connected Hosts* dialog. Type in the **host's** IP address (like 192.168.1.45) into the IP field of *Host Connection 1*, and make sure it is activated. The port defaults to 7009 and usually must not be changed. In case this port is unexpectedly occupied a warning message will be issued. Choose a different port then. Under Windows a Firewall warning will come up. Allow TotalMix Remote or it won't work.

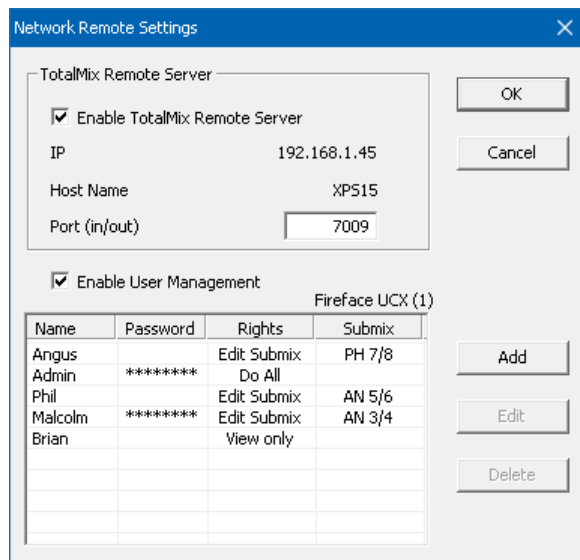

Tap Done on top or click Ok. In the mixer view the state should change from *offline* to *connected* within a few seconds.

The Add button provides access to the user-management that can be configured in detail. Here users can be defined, with and without a password, and the rights can be assigned to viewing only, changing a specific sub-mix, or full access. For example, using Total-Mix FX as a monitor controller for all band members, user-management prevents the bassist from changing the guitarist's monitor mix. Or the drummer making himself too loud. Etc.

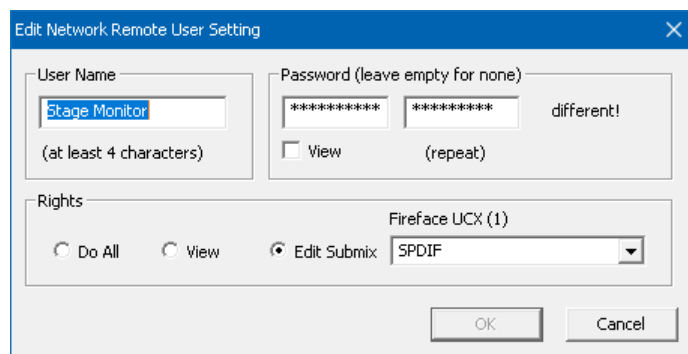

Tip

The remotes have the option *Sync Channel Layouts* active as default (in Preferences). This option transfers the Layout Presets and the current Channel Layout state from host to remote. Apart from the channel width state this option makes a mirror-style setup most easy. But when using the remote as individual setup, make sure to disable this option to have independent Layout Presets on the remote.

Limitations

- Mixer View & GUI. When connected the remote computer / iPad will immediately have the complete routing and FX settings of the host, including mono and stereo channels, but not the host's GUI setup, like panel states open/closed of Settings/EQ/Dynamic, FX panel visibility, 2-Row or 3-Row mode and channel width. Channel width states can be stored as usual per Snapshot and completely as Workspace, locally on the remote computer. They need to be loaded manually after loading a Workspace on the host in case a 100% identical view is required.
- Workspaces. The Remote shows the Quick Workspaces (hotkey W on Windows/Mac) stored on the host, and allows to remotely load them. It is not possible to save complete Workspaces with mixer state from the Remote, or on the Remote. The Workspaces saved locally include GUI information only (Channel state wide/narrow, Channel Layouts, window size and position) and further local settings, to be able to have personalized views on the remote computer, independent from the view on the host.
- Real-time behaviour. Can suffer when the network is overloaded or the WiFi reception is insufficient. Level Meters will stutter then and faders do not move smoothly.
- Background operation on iPad - is not possible. This should not be a problem as the Remote doesn't need to do anything in background, and when called up very quickly reconnects and synchronizes its state.
- State. Is shown in the upper right corner (offline or connected), or the Mac/Windows title bar.

Downloads

Remote Windows

http://www.rme-audio.de/downloads/tmfx_win_remote.zip

Remote Mac

http://www.rme-audio.de/downloads/tmfx_mac_remote.zip

iPad

From the Apple App Store, search for 'TotalMix Remote'. This app is free.



User's Guide



Babyface Pro *FS*

► **Technical Reference**

27. Technical Specifications

27.1 Analog

AD, Microphone/Line 1-2

- Input: XLR, electronically balanced
- Input impedance balanced: 2 kOhm, 5.2 kOhm with PAD
- Input impedance unbalanced: 1 kOhm, 2.6 kOhm with PAD
- Signal to Noise ratio (SNR): 113.7 dB RMS unweighted, 117 dBA
- Frequency response @ 44.1 kHz, -0.1 dB: 18 Hz – 20.8 kHz
- Frequency response @ 96 kHz, -0.5 dB: 7 Hz – 45.8 kHz
- Frequency response @ 192 kHz, -1 dB: 5 Hz – 88 kHz
- With PAD active : -0.1 dB 8 Hz, -0.5 dB < 4 Hz, -1 dB < 3 Hz
- THD: < -112 dB, < 0.00024 %
- THD+N: < -108 dB, < 0.00035 %
- THD @ 30 dB Gain: < -115 dB, < 0.00016 %
- THD+N @ 30 dB Gain: < -100 dB, < 0.001 %
- Channel separation: > 110 dB
- Gain range: -11 dB up to +65 dB
- Maximum input level XLR, Gain 0 dB: +8 dBu, PAD +19 dBu
- Maximum input level XLR, Gain 65 dB: -57 dBu, PAD -46 dBu

AD, Line/Instrument In 3-4

As Microphone/Line 1-2, but:

- Input: 6.3 mm TS jack, unbalanced
- Input impedance: 1 MOhm
- Signal to Noise ratio (SNR): 116 dB RMS unweighted, 120 dBA
- Frequency response @ 44.1 kHz, -0.1 dB: 5 Hz – 20.8 kHz
- Frequency response @ 96 kHz, -0.5 dB: < 3 Hz – 45.8 kHz
- Frequency response @ 192 kHz, -1 dB: < 2 Hz – 92 kHz
- Maximum input level @+4 dBu, Gain 0 dB: +13 dBu
- Maximum input level @-10 dBV, Gain 9 dB: -5 dBu

DA, Line Out 1-2 XLR

- Dynamic range (DR): 115 dB RMS unweighted, 118 dBA
- Frequency response @ 44.1 kHz, -0.5 dB: 0 Hz – 20.8 kHz
- Frequency response @ 96 kHz, -0.5 dB: 0 Hz – 45 kHz
- Frequency response @ 192 kHz, -1 dB: 0 Hz - 89 kHz
- THD: - 106 dB, 0.0005 %
- THD+N: -102 dB, 0.0008 %
- Channel separation: > 110 dB
- Output: XLR balanced
- Output impedance: 300 Ohm balanced, 150 Ohm unbalanced
- Output level @ 0 dBFS: Balanced +19 / +4 dBu, unbalanced +13 / -2 dBu
- DC @ 0 dBFS: 6.35mm 4.8 V, 3.5mm 2.4 V, XLR bal. 9.6 V

DA, Phones 3/4

As DA Line Out, but:

- Output: 6.3 mm TRS jack, unbalanced
- Output impedance: 10 Ohm
- Output level at 0 dBFS, 1 kOhm load: +13 dBu
- Max power @ 0.1% THD: 60 mW
- Signal to Noise ratio (SNR): 114.8 dB RMS unweighted, 118 dBA
- Noise level: -101.8 dBu

-
- Output: 3.5 mm TRS jack, unbalanced
 - Output impedance: 0.1 Ohm
 - Output level at 0 dBFS, 1 kOhm load: +7 dBu
 - Max power @ 0.1% THD: 90 mW
 - Signal to Noise ratio (SNR): 114 dB RMS unweighted, 117 dBA
 - Noise level: -107 dBu

27.2 MIDI

- 1 x MIDI I/O via breakout cable with 2 x 5-pin DIN jacks
- Galvanically isolated by optocoupled input
- Hi-speed mode: Jitter and response time typically below 1 ms
- Separate 128 byte FIFOs for input and output

27.3 Digital

- Clocks: Internal, ADAT In, SPDIF In
- Jitter suppression of external clocks: > 50 dB (2.4 kHz)
- Effective clock jitter influence on AD and DA conversion: near zero
- PLL ensures zero dropout, even at more than 100 ns jitter
- Digital Bitclock PLL for trouble-free varispeed ADAT operation
- Supported sample rates: 28 kHz up to 200 kHz

27.4 Digital Inputs

ADAT Optical

- 1 x TOSLINK
- Standard: 8 channels 24 bit, up to 48 kHz
- Double Speed (S/MUX): 4 channels 24 bit 96 kHz
- Quad Speed (S/MUX4) : 2 channels 24 bit 192 kHz
- Bitclock PLL ensures perfect synchronisation even in varispeed operation
- Lock Range: 31.5 kHz – 50 kHz
- Jitter suppression: > 50 dB (2.4 kHz)

SPDIF optical

- 1 x optical, according to IEC 60958
- Accepts Consumer and Professional format
- Lock Range: 27 kHz – 200 kHz
- Jitter suppression: > 50 dB (2.4 kHz)

27.5 Digital Outputs

ADAT optical

- 1 x TOSLINK
- Standard: 8 channels 24 bit, up to 48 kHz
- Double Speed (S/MUX): 4 channels 24 bit 96 kHz
- Quad Speed (S/MUX4) : 2 channels 24 bit 192 kHz

SPDIF optical

- 1 x optical, according to IEC 60958
- Format Consumer (SPDIF) according to IEC 60958
- Sample rate 28 kHz up to 200 kHz

27.6 General

- Power supply: USB bus power or external power supply
- Idle power consumption: 2.8 Watts
- Typical power consumption: 3.7 Watts
- Max. power consumption: 5.4 Watts
- Current at 5 V bus power operation: 700 mA (3.7 Watts)
- Current at 12 V external power: 313 mA (3.7 Watts)
- Dimensions (WxHxD): 108 x 35 x 181 mm (4.25" x 1.4" x 7.1")
- Weight: 680 g (1.5 lbs)
- Temperature range: +5° up to +50° Celsius (41° F up to 122°F)
- Relative humidity: < 75%, non condensing

Typical power consumption: Playback 1 kHz sine 0 dBFS, 2 x 32 Ohm at TRS 3.5 mm, XLR loopback -> nearly all LEDs lit in medium brightness.

Maximum power consumption: same, but XLR inputs shorted and phantom power activated.

28. Technical Background

28.1 Lock and SyncCheck

Digital signals consist of a carrier and the data. If a digital signal is applied to an input, the receiver has to synchronize to the carrier clock in order to read the data correctly. To achieve this, the receiver uses a PLL (Phase Locked Loop). As soon as the receiver meets the exact frequency of the incoming signal, it is locked. This **Lock** state remains even with small changes of the frequency, because the PLL tracks the receiver's frequency.

If an ADAT or SPDIF signal is applied to the Babyface Pro, the corresponding input LED starts flashing. The unit indicates LOCK, i. e. a valid input signal (in case the signal is also in sync, the LED is constantly lit, see below).

Unfortunately, LOCK does not necessarily mean that the received signal is correct with respect to the clock which processes the read out of the embedded data. Example [1]: The Babyface Pro is set to 44.1 kHz internally (clock mode Master), and a mixing desk with ADAT output is connected to input ADAT. The corresponding LED will show LOCK immediately, but usually the mixing desk's sample rate is generated internally (also Master), and thus slightly higher or lower than the Babyface Pro's internal sample rate. Result: When reading out the data, there will frequently be read errors that cause clicks and drop outs.

In order to display those problems optically at the device, the Babyface Pro includes **Sync-Check**. It checks all clocks used for *synchronicity*. If they are not synchronous to each other (i.e. absolutely identical) the SYNC LED flashes. In case they are completely synchronous the LED is constantly lit. In the above example the user would have noticed quickly that the LED kept on flashing after connecting the mixing desk.

The same information is presented in the Babyface Pro's Settings dialog. In the status display *Input State* the state of the input clock is decoded and shown as simple text (No Lock, Lock, Sync).

In practice, SyncCheck allows for a quick overview of the correct configuration of all digital devices. So one of the most difficult and error-prone topics of the digital studio world finally becomes easy to handle.

28.2 Latency and Monitoring

The term **Zero Latency Monitoring** was introduced by RME in 1998 for the DIGI96 series of audio cards. It stands for the ability to pass-through the computer's input signal at the interface directly to the output. Since then, the idea behind has become one of the most important features of modern hard disk recording. In the year 2000, RME published two ground-breaking Tech Infos on the topics *Low Latency Background*, which are still up-to-date: *Monitoring, ZLM and ASIO*, and *Buffer and Latency Jitter*, both found on the RME website.

How much Zero is Zero?

From a technical view there is no zero. Even the analog pass-through is subject to phase errors, equalling a delay between input and output. However, delays below certain values can subjectively be claimed to be zero latency. This applies to analog routing and mixing, and in our opinion also to RME's Zero Latency Monitoring. The term describes the direct digital path from the interface's input to output. Digital receiver buffers plus TotalMix and output transmitter show a typical delay of 3 samples. At 44.1 kHz this equals about 68 μ s (0.000068 s), at 192 kHz only 15 μ s. The delay is valid for ADAT and SPDIF in the same way.

Oversampling

While the delays of digital interfaces can be disregarded altogether, the analog inputs and outputs do cause a significant delay. Converter chips operate with 64 or 128 times oversampling plus digital filtering. This typically generates a delay of one millisecond. A playback and re-record of the same signal via DA and AD (loopback) causes an offset to the newly recorded track of about 2 ms.

Low Latency!

The Babyface Pro uses AD/DA converters with latest digital filters, causing a delay of only a few samples. With 5 samples AD and 7 samples DA the delay caused by the conversion is only about a fifth of previous generations. The delays of the Babyface Pro FS AD/DA are:

Sample frequency kHz	44.1	48	88.2	96	176.4	192
AD (5 x 1/fs) ms	0.11	0.10				
AD (5 x 1/fs) ms			0.05	0.05		
AD (6 x 1/fs) ms					0.034	0.031
DA (7 x 1/fs) ms	0.16	0.15	0.08	0.07	0.04	0.036

Buffer Size (Latency)

Windows: This option found in the Settings dialog defines the size of the buffers for the audio data used in ASIO and WDM (see chapter 10).

Mac OS X: The buffer size is defined within the application. Only some do not offer any setting. For example iTunes is fixed to 512 samples.

General: A setting of 64 samples at 44.1 kHz causes a latency of 1.5 ms, for record and playback each. But when performing a digital loopback test no latency/offset can be detected. The reason is that the software naturally knows the size of the buffers, therefore is able to position the newly recorded data at a place equalling a latency-free system.

AD/DA Offset under ASIO and OS X: ASIO (Windows) and Core Audio (Mac OS X) allow for the signalling of an offset value to correct buffer independent delays, like AD- and DA-conversion or the Safety Buffer described below. An analog loopback test will then show no offset, because the application shifts the recorded data accordingly. Because in real world operation analog record and playback is unavoidable, the drivers include an offset value matching the Babyface Pro converter delays.

Therefore, in a **digital** loopback test a *negative* offset of about 1 ms occurs. This is no real problem, because this way of working is more than rare, and usually the offset can be compensated manually within the application. Additionally, keep in mind that even when using the digital I/Os usually at some place an AD- and DA-conversion is involved (no sound without...).

Note: Cubase and Nuendo display the latency values signalled from the driver separately for record and playback. The values do not exactly equal the buffer size (for example 3 ms at 128 samples), instead a higher value is shown, including the time needed for the AD/DA-conversion. Playback shows an even higher value – see Safety Buffer.

Safety Buffer

An additional small Safety Buffer on the playback side has proven to be very efficient and useful. The Babyface Pro uses a fixed additional buffer of 32 samples, which is added to the current buffer size. The main advantage is the ability to use lowest latency at highest CPU loads. Furthermore, the fixed buffer does not add to the latency jitter (see Tech Info), the subjective timing is extraordinary.

Core Audio's Safety Offset

Under OS X, every audio interface has to use a so called *Safety Offset* on record and playback, otherwise Core Audio won't operate click-free. The Babyface Pro uses a Safety Offset of 16 samples. This offset is signalled to the system, and the software can calculate and display the total latency of buffer size plus AD/DA offset plus 2 x Safety Offset plus Safety Buffer for the current sample rate.

28.3 USB Audio

USB audio is in several ways different from PCI based audio interfaces. A Babyface Pro can achieve a performance similar to a PCI or PCI Express card when used with an optimal PC. Low CPU load and click-free operation even at 48 samples buffer size are indeed possible on current computers. However, using older computers a simple stereo playback will begin to cause a CPU load of more than 30%.

A computer blocked for a short time – no matter if ASIO or WDM – will lose one or more data packets. Such problems can only be solved by increasing the buffer size (and with this the latency).

The Babyface Pro features a unique data checking, detecting errors during transmission via USB and displaying them in the Settings dialog.

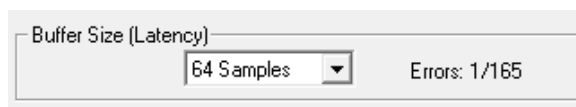

Additionally the Babyface Pro provides a special mechanism to continue recording and playback in case of drop-outs, and to correct the sample position in real-time.

Like any audio interface the Babyface Pro should have a data transmission to the computer as undisturbed as possible. The easiest way to guarantee this is to connect it to its own bus, which should be no big problem as most USB 2.0 interfaces are a double bus design. A check in the Device Manager can be done as follows:

- Connect the Babyface Pro to a USB port
- Start the Device Manager, View set to Devices by Connection
- Select ACPI x86-based PC, Microsoft ACPI-Compliant System, expand PCI Bus

This branch normally includes two entries of a *USB2 Enhanced Host Controller*. A USB Root Hub can be seen, which then connects all USB devices, including the Babyface Pro. By reconnecting to a different port this view immediately shows at which of the two controllers the Babyface Pro is connected. With multiple devices it can also be checked if they are connected to the same controller.

Furthermore this information can be used to operate an external USB drive without disturbing the Babyface Pro, by simply connecting the drive to the other controller.

Especially with notebooks it can happen that all internal devices and all the sockets/ports are connected to the same controller, with the second controller not used at all. In that case all devices have to use the same bus and interfere with each other.

28.4 DS - Double Speed

When activating the *Double Speed* mode the Babyface Pro operates at double sample rate. The internal clock 44.1 kHz turns to 88.2 kHz, 48 kHz to 96 kHz. The internal resolution is still 24 bit.

Sample rates above 48 kHz were not always taken for granted, and are still not widely used because of the CD format (44.1 kHz) dominating everything. Before 1998 there were no receiver/transmitter circuits available that could receive or transmit more than 48 kHz. Therefore a work-around was used: instead of two channels, one AES line only carries one channel with its odd and even samples being distributed to the former left and right channels. By this, you get the double amount of data, i. e. also double sample rate. Of course in order to transmit a stereo signal two AES/EBU ports are necessary then.

This transmission mode is called *Double Wire* in the professional studio world, and is also known as *S/MUX (Sample Multiplexing)* in connection with the ADAT format.

Not before February 1998, Crystal shipped the first 'single wire' receiver/transmitters that could also work with double sample rate. It was then possible to transmit two channels of 96 kHz data via one AES/EBU port.

But *Double Wire* is still far from being dead. On one hand, there are still many devices which can't handle more than 48 kHz, e. g. digital tape recorders. But also other common interfaces like ADAT or TDIF are still using this technique.

Because the ADAT interface does not allow for sampling frequencies above 48 kHz (a limitation of the interface hardware), the Babyface Pro automatically uses *Sample Multiplexing* in DS mode. One channel's data is distributed to two channels according to the following table:

Analog In	1	2	3	4	5	6	7	8
DS Signal Port	1/2 ADAT	3/4 ADAT	5/6 ADAT	7/8 ADAT	-	-	-	

As the transmission of double rate signals is done at standard sample rate (Single Speed), the ADAT output still delivers 44.1 kHz or 48 kHz.

28.5 QS – Quad Speed

Due to the small number of available devices that use sample rates up to 192 kHz, but even more due to a missing real world application (CD...), Quad Speed has had no broad success so far. An implementation of the ADAT format as double S/MUX results in only two channels per optical output. There are few devices using this method.

In Quad Speed mode the Babyface Pro automatically uses *Sample Multiplexing*. One channel's data is distributed to four channels according to the following table:

Analog In	1	2	3	4	5	6	7	8
DS Signal Port	1/2/3/4 ADAT	5/6/7/8 ADAT	-	-	-	-	-	-

As the transmission of quad rate signals is done at standard sample rate (Single Speed), the ADAT output still delivers 44.1 kHz or 48 kHz.

28.6 Noise Level in DS / QS Mode

The outstanding signal to noise ratio of the Babyface Pro's AD-converters can be verified even without expensive test equipment, by using record level meters of various software. But when activating the DS and QS mode, the displayed noise level will rise from -114 dB to -108 dB at 96 kHz, and -88 dB at 192 kHz. This is not a failure. The software measures the noise of the whole frequency range, at 96 kHz from 0 Hz to 48 kHz (RMS unweighted), at 192 kHz from 0 Hz to 96 kHz.

When limiting the measurement range from 20 Hz to 20 kHz (so called audio bandpass) the value would be -113 dB again. This can be verified with RME's *DIGICheck*. The function **Bit Statistic & Noise** measures the noise floor by *Limited Bandwidth*, ignoring DC and ultrasound.

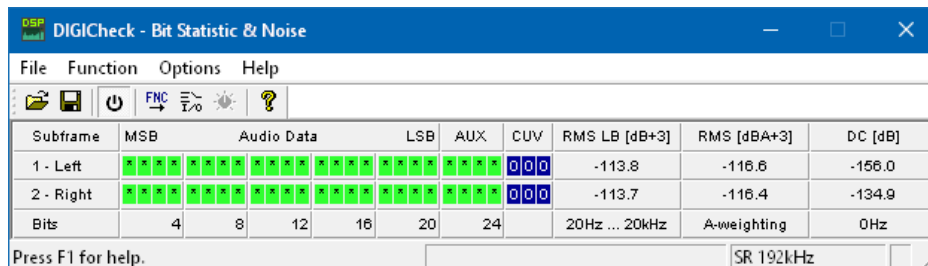

Subframe	MSB	Audio Data	LSB	AUX	CUV	RMS LB [dB+3]	RMS [dBA+3]	DC [dB]	
1 - Left	████████	████████	████████	████████	000	-113.8	-116.6	-156.0	
2 - Right	████████	████████	████████	████████	000	-113.7	-116.4	-134.9	
Bits	4	8	12	16	20	24	20Hz ... 20kHz	A-weighting	0Hz

The reason for this behaviour is the noise shaping technology of the analog to digital converters. They move all noise and distortion to the inaudible higher frequency range, above 24 kHz. That's how they achieve their outstanding performance and sonic clarity. Therefore the noise is slightly increased in the ultrasound area. High-frequency noise has high energy. Add the doubled (quadrupled) bandwidth, and a wideband measurement will show a significant drop in SNR, while the human ear will notice absolutely no change in the audible noise floor.

28.7 SteadyClock

The further improved SteadyClock FS technology of the Babyface Pro FS guarantees an excellent performance in all clock modes. Thanks to a highly efficient jitter suppression, the AD- and DA-conversion always operates on highest sonic level, being completely independent from the quality of the incoming clock signal.

SteadyClock has been originally developed to gain a stable and clean clock from the heavily jittery MADI data signal (the embedded MADI clock suffers from about 80 ns jitter). Using the Babyface Pro's input signals SPDIF and ADAT, you'll most probably never experience such high jitter values. But SteadyClock is not only ready for them, it would handle them just on the fly.

Common interface jitter values in real world applications are below 10 ns, a very good value is less than 2 ns.

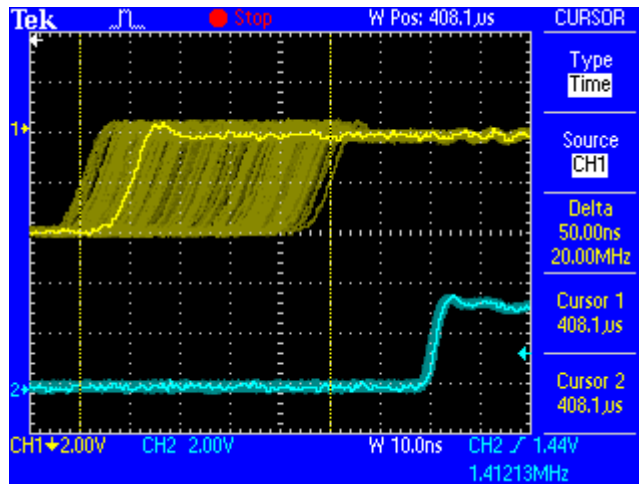

The screenshot shows an extremely jittery SPDIF signal of about 50 ns jitter (top graph, yellow). SteadyClock turns this signal into a clock with less than 2 ns jitter (lower graph, blue). The signal processed by SteadyClock is of course not only used internally, but also used to clock the digital output. Therefore the refreshed and jitter-cleaned signal can be used as reference clock without hesitation.

29. Diagrams

29.1 Block Diagram Babyface Pro FS

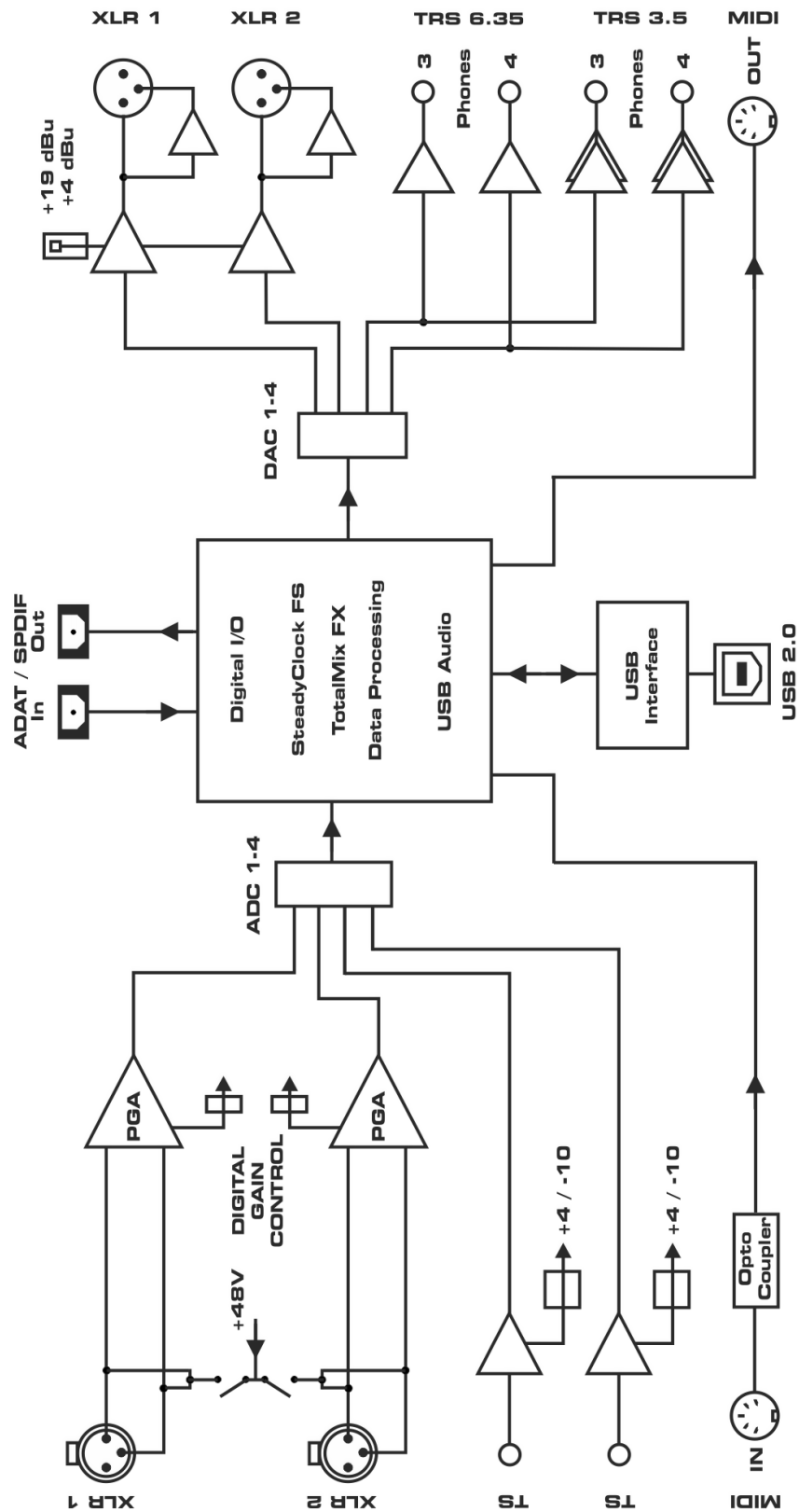

29.2 Connector Pinouts

TS jack analog instrument input

The 1/4" TS jacks of the universal line/instrument inputs are wired according to international standards:

Tip = + (hot), Ring = GND, Sleeve = GND.

XLR Connectors

The XLR sockets of the analog I/Os are wired according to international standards:

1 = GND (Shield), 2 = + (hot), 3 = - (cold).

The servo-balanced **input** circuitry allows to use monaural TS jacks (unbalanced) with no loss in level. This is the same as when using a TRS-jack with ring connected to ground.

- ! *The electronic **output** stage does not operate servo-balanced! When connecting unbalanced equipment, make sure pin 3 of the XLR output is not connected. A connection to ground might cause higher THD (distortion) and power consumption!*

TRS Phones jack

The output channels 3/4 feed the two **Phones** outputs via two independent driver circuits, optimized for high (TRS 1/4", 6.35mm) and low impedance (TRS 1/8", 3.5mm) headphones

In case this output should operate as Line output, an adapter TRS plug to RCA phono plugs, or TRS plug to TS plugs is required.

The pin assignment follows international standards. The left channel is connected to the tip, the right channel to the ring of the TRS jack/plug.

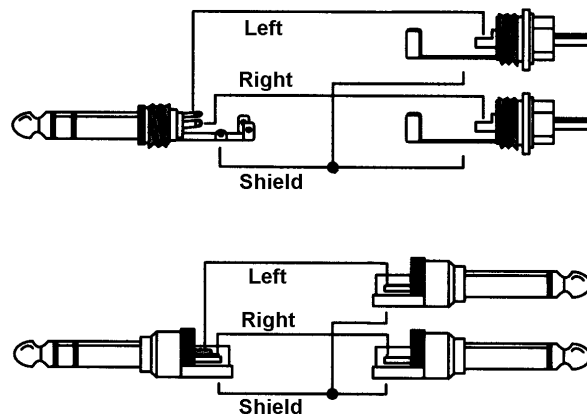

6-pin Mini-DIN MIDI breakout cable

Pin	Name
1	GND/Shell/MIDI Out (2)
2	GND/Shell
3	MIDI In (5, -)
4	MIDI Out (5, -)
5	MIDI In (4, +)
6	MIDI Out (4, +)

User's Guide



Babyface Pro *FS*

▶ Stand-Alone and Class Compliant Mode

30. General

The Babyface Pro operates in three different modes: **driver-based USB 2 (Windows, Mac OS X)**, **stand-alone** mode (without being connected to a computer), and **Class Compliant** mode, mainly for iPad® connectivity. The latter describes a standard that is natively supported by operating systems like Mac OS X and Linux. No proprietary drivers are required, the device will be directly recognized when CC mode is activated. Obviously, native features will be limited in comparison to those provided by the RME driver set. For example there will be no (Total) Mix and no effects. However, on the iPad (iOS) the Babyface Pro can be fully controlled by the optional app *TotalMix FX for iPad*.

The Babyface Pro provides the iPad with the professional analog I/O connections it lacks. Superb microphone preamps, in addition to professional balanced line outputs, and a hi-power headphone output that excels with both high and low impedance headphones. Plus gain and level adjustments, SPDIF and ADAT input and output, at up to 192 kHz and 24 bit. And of course a Sysex capable MIDI I/O.

In stand-alone mode the Babyface Pro needs to be powered. You have the choice to use USB bus power by one of the numerous LiPo batteries with USB ports, sold as mobile power for your smartphone and iPad, or an external power supply.

In Class Compliant mode connected to an iPad the Babyface Pro needs to be operated with an external standard power supply, like the ones provided by RME (9 to 12 Volts and around 1 A). For mobile applications please note that LiPo batteries are also available in advanced versions which offer a 9 to 12 V output.

The Babyface Pro features no automatic power on/off due to its low idle power consumption of below 3 Watts.

31. System requirements for iOS operation

- Babyface Pro with external power supply and activated Class Compliant mode
- Any Apple iPad with at least iOS 6 or an iPhone with at least iOS 7
- Apple iPad Camera Connection Kit or Lightning to USB adapter
- iPad Pro: no adapters, just a USB-B to USB-C cable

32. Class Compliant Operation

Activation of the Class Compliant mode

Hold down the **SELECT** and **DIM** button until the level meters show **CC**, confirming CC mode is activated. CC mode is shown on the level meters on every power-on of the unit. When nothing is shown then the unit is in PC mode.

Using an external power supply and USB disconnected the mode can be changed back and forth between CC and PC. In this case PC is shown on the level meters after the reconfiguration.

Connect the USB cable to the Camera Connection Kit/Lightning adapter. Start the iPad and plug the Kit/adaptor into the iPad's socket. If everything works as expected, the unit will be used for all audio I/O. Audio playback in iTunes will automatically be performed by the Babyface Pro, using analog outputs 1/2, and - with Copy mode - active on phones outputs 3/4 and SPDIF/ADAT.

Apps that support MIDI and are ready for Core MIDI (available since iOS 4.2) will offer dialogs to select the desired Babyface Pro MIDI input and output.

32.1 Useful hints

If the unit is not in CC mode, the iPad will detect an incompatible USB device, and display a message saying “Cannot Use Device – The connected USB device is not supported”.



When the power supply for the Babyface Pro is insufficient, iOS will complain about the attached unit drawing too much power.

The iPad's volume control is inactive during USB operation.

Since 2016 Apple offers another version of the *USB to Lightning Adapter*, called *Lightning to USB 3 Camera Adapter*. It has an additional Lightning port for power supply that charges the iPhone/iPad even when used with the Babyface Pro.

The iPad Pro (with USB-C) offers full USB connectivity. It supplies the Babyface Pro with power, and allows the use of a USB hub, and thus the connection of the optional ARC USB, which is supported by the apps *TotalMix FX for iPad* and *TotalMix Remote*.

32.2 Class Compliant Mode under Windows and Mac OS X

On a Windows PC, Class Compliant mode is indicated by a missing “RME” in the device name shown in the Device Manager. In the correct mode (PC) and with installed drivers, the full name including RME is shown, without serial number.

Mac OS X supports Class Compliant USB Audio 2.0, even with more than 2 channels. The Babyface offers full 12 input and 12 output channels at up to 192 kHz. It is shown as “Babyface Pro (xxxxxxx)” in the Audio MIDI Setup, in both PC and CC mode. In CC mode the USB Settings will vanish from the Dock, and TotalMix FX will not start, or show a ‘disconnected’ Babyface Pro.

The Audio window in the Audio MIDI Setup lists two available modes: 2 channels and 12 channels. The sample rate shown here as ‘Default’ is the one set at the Babyface Pro.

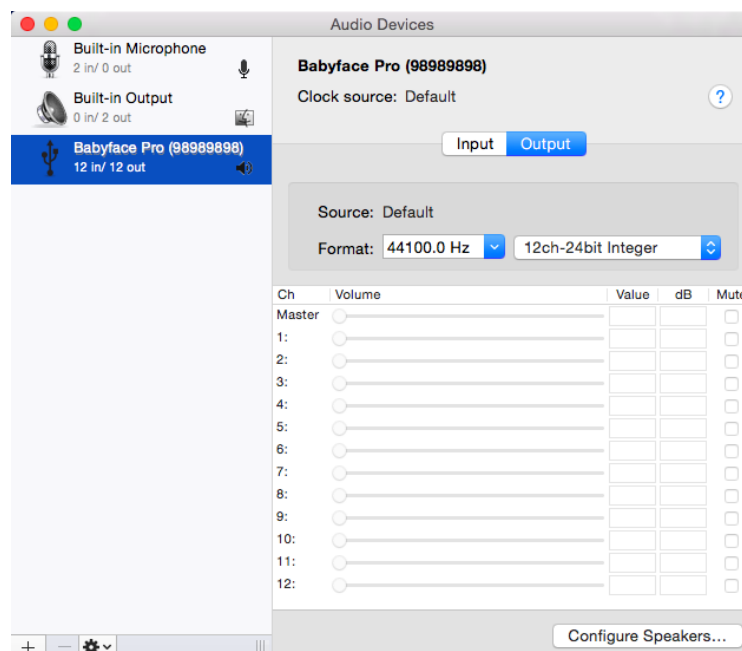

33. Supported Inputs and Outputs

33.1 Class Compliant Mode

In Mac OS X, either the first two or all channels will work, depending on the choice in the Audio MIDI Setup. The playback signal of channels 1/2 can be copied to outputs 3/4 and SPDIF/ADAT by activating the *Copy Mode* (see chapter 34).

When connected to an iPad, the analog mic/line input 1 works with mono apps, inputs 1 and 2 with stereo apps (both dual mono and stereo), and up to 8 inputs with 8-channel applications like *MultiTrack DAW* and *Music Studio*. *Garage Band* supports all 12 inputs, but only two at a time. *Auria* and *Cubasis* can record all 12 inputs simultaneously.

Playback will use analog outputs 1 and 2, or even more channels if the app supports such operation. The Babyface Pro onboard mixer can copy the output signal 1/2 to outputs 3/4, SPDIF and ADAT simultaneously, see chapter 34 - *Copy Mode*.

In Class Compliant mode the default clock mode is AutoSync at 44.1 kHz. The Babyface Pro (and with it the iPad) will be synchronized to an external digital sample rate if there is a valid digital input signal. With a wrong sample rate heavy audio noise will occur. Without an SPDIF or ADAT input signal the Babyface Pro enters master mode and uses the sample rate set by Mac OS X or iOS (the app in use). The Babyface Pro can be set to fixed Master mode as well, but the set sample rate is ignored, as the iPad (the current app) controls the sample rate value.

While the MIDI I/Os will send and receive Sysex messages, not all apps are ready to do this. The app *Midi Tool Box* can be used to verify that the Babyface Pro is working correctly, and the problem lies somewhere else.

33.2 Stand-Alone Mode

Switching on the unit without being connected to USB activates stand-alone mode, no matter if the unit has been set to PC or CC mode before. In this mode the unit offers extensive configuration options, like clocking and routing/mixing, that turn it into lots of useful, hi-quality tools. Examples are a 2 channel microphone preamp with analog and digital output, a headphone amp with analog and digital inputs, and many more.

The clock modes are the same as in CC mode, but here the chosen sample rate is indeed used by the unit. To recap what AutoSync means:

- Without further configuration and no digital input signal, it will default to 44.1 kHz internal sample rate.
- When receiving a digital input signal in SPDIF format, it will sync itself on the external sample rate, from 32 kHz to 192 kHz.
- When receiving a digital input signal in ADAT format, it will sync itself on the external sample rate, from 32 to 48 kHz. Double Speed mode is automatically set when receiving an ADAT signal from other RME devices. Otherwise the setting has to be performed manually (see next chapter).

The input signals can be routed/mixed to the outputs by activating the unit's *Mix mode*:

- Use **OUT** to select the desired output
- Use **IN** to select the input with the desired signal source
- Push **MIX**. The input LEDs start to flash.
- Use **SELECT** to choose between left, right or both input channels
- Turn the big knob to set the actual monitoring/routing level
- Continue with all inputs and outputs as you wish

While the setup is simplified (no panorama available) it is still very efficient and will address most needs. Also a different input can be mixed onto the same output.

Of the eight ADAT channels only channels 1/2 can be controlled from the Babyface Pro.

! All settings are stored within the unit and do not get lost until the next time stand-alone mode is used.

34. Operation at the Unit

Operation at the unit is very similar to the one under Windows and OS X, with some additions. These were done as intuitive and easy to remember as possible.

Changing between normal and CC mode

When connected to a Windows or Mac computer, the USB data connection prevents switching the mode. In such a case it is possible only during power-up to be able to revert from CC to normal mode:

Hold down the keys **SELECT** and **DIM** while inserting the USB cable. During the boot process the level meters show CC for about 2 seconds, confirming the CC mode has been activated. The Babyface Pro stays in CC mode until this procedure has been performed again, it will then show PC.

When not connected to a Windows or Mac computer, the mode can be changed any time. Therefore, with USB bus power (via LiPo battery) or when connected to an external power supply: Hold down the keys **SELECT** and **DIM** for two seconds. The level meters will show the new mode, either PC or CC. Hold them down again to change back.

CC mode is shown on every boot of the unit. PC mode is shown only during the switching process.

DIM

Select Ch 1/2, Phones or Opt via OUT, then push the DIM button. DIM can be used on any of the three outputs, and applies a fixed attenuation of 20 dB.

48V Phantom power on/off

Use **IN** to select Ch 1/2. Use **SELECT** to choose left, right or both channels. A push on **SET** will activate Phantom power and turn on the orange LED labeled P48.

Copy Mode (Playback Output Routing for iOS)

A stereo playback of iPad/iPhone defaults to output channels 1/2. To hear the audio also at the Phones output, or even at the SPDIF/ADAT output, the Babyface includes an optional Copy mode, where the playback signal of channels 1/2 is copied to outputs 3/4 and channels 1/2 of SPDIF/ADAT.

Use **OUT** to select OUTPUT Ch 1/2. Push **SET**. The current state of the Copy mode is shown by the three OUTPUT state LEDs:

- Only Ch 1/2 lit: Copy Mode not active
- Ch 1/2, Phones and Opt lit: Copy mode active.

Use **SELECT** to turn Copy mode on and off.

! Copy mode is not available when TotalMix FX for iPad is detected by the Babyface Pro.

Switch digital output format (SPDIF <=> ADAT)

Use **OUT** to select the optical output (Opt.). Push **SET**. The level meter will signal ADAT mode with 8 LEDs, SPDIF mode with 2 LEDs turned on. Use **SELECT** to switch between them.

Set Clock Mode and Sample Rate

Push **SET** for two seconds. The level meters will now signal the current clock mode and sample rate. Use **SELECT** to step through all available options:

Master 44.1 kHz

Master 48 kHz

Master 88.2 kHz

Master 96 kHz

Master 176.4 kHz

Master 192 kHz

AutoSync

AutoSync, Double Speed mode in case input = ADAT (2x SMUX)

AutoSync, Quad Speed mode in case input = ADAT (4x SMUX)

Thanks to the four level meters all settings are shown in an intuitive and easy to 'decode' way. Master 44.1 kHz is signaled with no LED lit in the first level meter, 4 in the second and third, and 1 LED in the fourth. So the meters show 0441. Master 176.4 kHz is shown as 1 LED, 7, 6 and 4 LEDs - 1764.

The AutoSync modes cover the single, double and quad speed frequency range, and are signaled as 1 bar, 2 bars or 4 bars respectively.

Set Clock Mode and Sample Rate can be exit by any of the 4 buttons below the level meters.

In CC mode, the sample rate value is ignored, as it is set by the app currently used on the iPad. Still the unit can be set into fixed clock mode 'master' by selecting one of the Master settings.

This setting can be quite useful. When pulling the cable from the iPad, the Babyface Pro immediately enters stand-alone mode – and would turn to the user-preferred sample rate.

Monitoring – MIX

The Babyface Pro uses TotalMix technology for routing/mixing in all modes. Setup:

- Use **OUT** to select the output for the monitoring, i.e. where the signal will be routed to
- Use **IN** to select the input with the signal that should be monitored
- Push **MIX**. The input level LEDs start to flash
- Use **SELECT** to choose between left, right or both channels
- Turn the encoder to set the actual monitoring level

While the setup is simplified (no panorama available) it is still very efficient and will address most needs. Also a different input can be mixed onto the same output.

Of the eight ADAT channels only channels 1/2 can be controlled from the Babyface Pro.

! *All settings are stored within the unit and do not get lost until the next time CC mode or stand-alone mode is used.*

35. Application Examples for Stand-Alone Mode

Here are two examples of setting up and using the Babyface Pro in stand-alone mode.

Universal DA-Converter

Connect the Babyface Pro via SPDIF to your CD-player, MP3 player or whatever device digitally playing audio at up to 192 kHz. Comfortably adjust the hearing level with the rotary encoder. Push DIM for a quick mute, and use the internal mixer to send the converted digital input signal to both XLR and Phones outs.

Analog Microphone Preamp

Activate phantom power if necessary, then set the Mic gain as needed. Set the Babyface Pro to Master 192 kHz for widest frequency range and lowest delay. Use the internal mixer to send the analog input signal to the analog outputs – finished. The total delay from the internal AD to DA conversion is a ridiculous 20 samples, which at 192 kHz is a real 0.1 ms – forget it.

With this setup the analog input signal is amplified to line level, available at 4 individually adjustable analog outputs as well as an digital output in either SPDIF or ADAT format. Options galore!

Using EQ in stand-alone mode

The Babyface Pro has neither controls nor memory for the DSP functions. Therefore in stand-alone mode EQs are not available.

There is a workaround though: when using TotalMix FX under Mac or Windows, and powering the Babyface Pro with an external power supply, pulling the USB cable will retain the whole current state, including EQs activated on all I/Os. Changing input gains and output levels as well as monitoring volume can be done directly at the unit as usual. This 'online' state gets lost the moment the unit loses power, it then enters the normal 'offline' stand-alone mode as stored in its memory (last usage in full stand-alone mode), and of course without EQs.

36. Useful notes

Mobile Operation

USB bus power can be delivered by a rechargeable battery. These days LiPo batteries with USB ports are very popular, usually used to charge your mobile gadgets on the go. They are lightweight, have an astonishing capacity, can be recharged quickly many times, and are not expensive. And they have a USB port. We tried several of those with 4,200 mAh and more. The Babyface Pro worked for several hours while playing music, with bigger batteries more than 10 hours. Batteries from 10,000 mAh and up are also available with 9 to 12 V output. These avoid potential bus power issues with peak loads over less than optimal USB cables, as they would provide power to the external power supply connector of the Babyface Pro – and also enable iPad mobile operation without having to use an Y USB cable. This one provides both data connection between iPad and Babyface Pro, and power over USB for the Babyface.

User's Guide



Babyface Pro *FS*

► Miscellaneous

37. Accessories

There are several items available for the Babyface Pro:

Part Number	Description
-------------	-------------

Optical cable for SPDIF and ADAT operation:

OK0100PRO	Optical cable, TOSLINK, 1 m (3.3 ft)
OK0200PRO	Optical cable, TOSLINK, 2 m (6.6 ft)
OK0300PRO	Optical cable, TOSLINK, 3 m (9.9 ft)
BF2USB	RME USB 2 cable, A plug to 90° B plug, length 39" (1m)
BF2USB-C	RME USB 2 cable, C plug to 90° B plug, length 39" (1m)
BF2MIDIBOC	RME MIDI Breakout cable for Babyface Pro
NT-RME-2	Power supply for Babyface Pro. Robust and light-weight switching power supply, 100 V-240 V AC, 12 V 2 A DC. Lockable DC connector.

38. Warranty

Each individual Babyface Pro undergoes comprehensive quality control and a complete test before shipping. The usage of high grade components should guarantee a long and trouble-free operation of the unit.

If you suspect that your product is faulty, please contact your local retailer. Do not open the device by yourself as it may get damaged. It has been sealed with tamper-evident material, and your warranty is void if those seals have been damaged.

Audio AG grants a limited manufacturer warranty of 6 months from the day of invoice showing the date of sale. The length of the warranty period is different per country. Please contact your local distributor for extended warranty information and service. Note that each country may have regional specific warranty implications.

In any case warranty does not cover damage caused by improper installation or maltreatment - replacement or repair in such cases can only be carried out at the owner's expense.

No warranty service is provided when the product is not returned to the local distributor in the region where the product had been originally shipped.

Audio AG does not accept claims for damages of any kind, especially consequential damage. Liability is limited to the value of the Babyface Pro. The general terms of business drawn up by Audio AG apply at all times.

39. Appendix

RME news, driver updates and further product information are available on our website:

<https://www.rme-audio.com>

Worldwide distribution: Audio AG, Am Pfanderling 60, D-85778 Haimhausen, Tel.: (49) 08133 / 918170

Support via e-mail: support@rme-audio.com

List of international supporters: <https://www.rme-audio.de/support.html>

RME user forum: <https://forum.rme-audio.de>

Trademarks

All trademarks, registered or otherwise, are the property of their respective owners. RME, DIGICheck and Hammerfall are registered trademarks of RME Intelligent Audio Solutions. Babyface, Babyface Pro, Babyface Pro FS, SyncCheck, ZLM, SyncAlign, TMS, TotalMix, TotalMix FX, SteadyClock and SteadyClock FS are trademarks of RME Intelligent Audio Solutions. Alesis and ADAT are registered trademarks of Alesis Corp. ADAT optical is a trademark of Alesis Corp. Microsoft, Windows 7/8/10 are registered trademarks or trademarks of Microsoft Corp. Apple, iPad, iPhone, Mac OS and macOS X are registered trademarks of Apple Inc. Steinberg, Cubase and VST are registered trademarks of Steinberg Media Technologies GmbH. ASIO is a trademark of Steinberg Media Technologies GmbH.

Copyright © Matthias Carstens, 09/2020. Version 1.5
Current driver version: W: 1.169, Mac OS X: 2.22 / 3.20, Firmware 127
TotalMix FX: 1.66

Although the contents of this User's Guide have been thoroughly checked for errors, RME can not guarantee that it is correct throughout. RME does not accept responsibility for any misleading or incorrect information within this guide. Lending or copying any part of the guide or the RME Driver CD, or any commercial exploitation of these media without express written permission from RME Intelligent Audio Solutions is prohibited. RME reserves the right to change specifications at any time without notice.

Note on Disposal

According to the guide line RL2012/19/EU (WEEE – Directive on Waste Electrical and Electronic Equipment), valid for all European countries, this product has to be recycled at the end of its lifetime.

In case a disposal of electronic waste is not possible, the recycling can also be done by Audio AG.

For this the device has to be sent **free to the door** to:

Audio AG
Am Pfanderling 60
D-85778 Haimhausen
Germany



Shipments not prepaid will be rejected and returned on the original sender's costs.

40. Declaration of Conformity

CE

This device has been tested and found to comply with the limits of the European Council Directive on the approximation of the laws of the member states relating to electromagnetic compatibility according to RL2014/30/EU, and European Low Voltage Directive RL2014/35/EU.

FCC

This device complies with Part 15 of the FCC Rules. Operation is subject to the following two conditions: (1) This device may not cause harmful interference, and (2) This device must accept any interference received, including interference that may cause undesired operation.

Warning: Changes or modifications to this unit not expressly approved by the party responsible for compliance could void the user's authority to operate the equipment.

Responsible Party in USA:

Synthax United States, 6600 NW 16th Street, Suite 10, Ft Lauderdale, FL 33313
T.:754.206.4220

Trade Name: RME, Model Number: Babyface Pro FS

This equipment has been tested and found to comply with the limits for a Class B digital device, pursuant to Part 15 of the FCC Rules. These limits are designed to provide reasonable protection against harmful interference in a residential installation. This equipment generates, uses, and can radiate radio frequency energy and, if not installed and used in accordance with the instructions, may cause harmful interference to radio communications. However, there is no guarantee that interference will not occur in a particular installation. If this equipment does cause harmful interference to radio or television reception, which can be determined by turning the equipment off and on, the user is encouraged to try to correct the interference by one or more of the following measures:

- Reorient or relocate the receiving antenna.
- Increase the separation between the equipment and receiver.
- Connect the equipment into an outlet on a circuit different from that to which the receiver is connected.
- Consult the dealer or an experienced radio/TV technician for help.

Caution: To comply with the limits of the Class B digital device, pursuant to Part 15 of the FCC Rules, this device must be used with computer equipment certified to comply with Class B limits. All cables used to connect to the computer and peripherals must be shielded and grounded. Operation with non-certified computers or unshielded cables may cause interference to radio or television reception.

RoHS Notice

This product has been soldered lead-free and fulfils the requirements of the RoHS directive.