

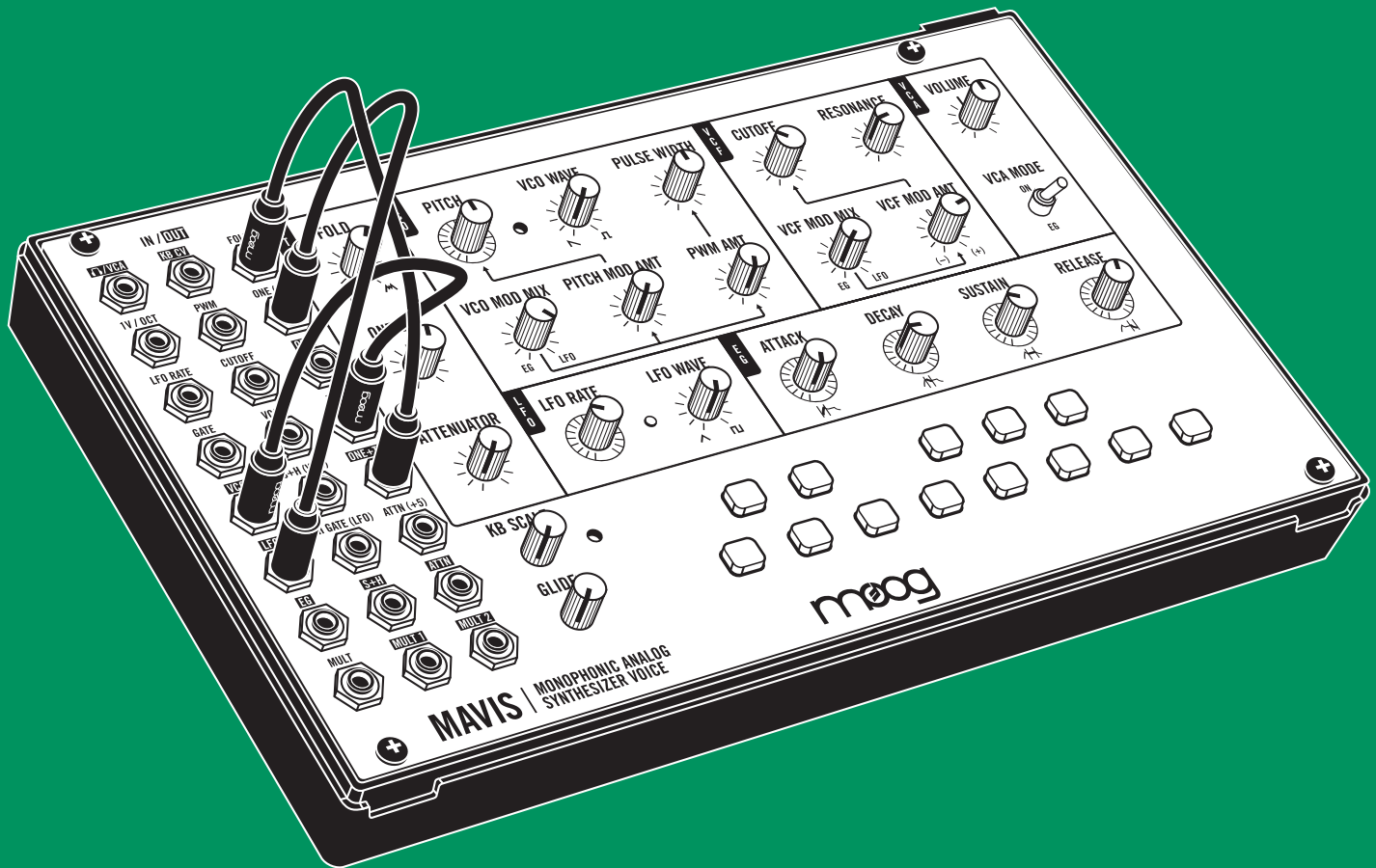

MAVIS

USER'S MANUAL



“Everything has some consciousness, and we tap into that. It is about energy at its most basic level.”

- Dr. Robert Moog -

Important Safety Instructions

WARNING: WHEN USING ELECTRIC PRODUCTS, THESE BASIC PRECAUTIONS SHOULD ALWAYS BE FOLLOWED.

1. Read and follow all the instructions before using the product. Heed all warnings and keep these instructions for later reference.
2. Do not use apparatus near water—for example, but not limited to, near a bathtub, washbowl, or kitchen sink; in a wet basement; or near a swimming pool.
3. Clean only with dry cloth.
4. Do not block any ventilation openings. Install in accordance with the manufacturer's instructions.
5. Do not install near any heat sources such as radiators, stoves, or other apparatus (including amplifiers) that produce heat. Do not operate this apparatus with the case in direct sunlight.
6. Protect the power cord from being walked on or pinched particularly at plugs, convenience receptacles, and the point where they exit from the apparatus.
7. Use attachments/accessories specified by the manufacturer. Ensure that any external equipment used in conjunction with this product is installed according to the safety specifications supplied with that equipment.
8. Unplug this apparatus during lightning storms or when unused for a long period of time.
9. This product, in combination with an amplifier and headphones or speakers, may be capable of producing sound levels that could cause permanent hearing loss. Do not operate for a long period of time at a high volume level or at a level that is uncomfortable.
10. The product should only be connected to the AC adapter supplied with the product. Do not connect the AC adapter to an AC outlet that is outside the adapter's input specifications.
11. Care should be taken so that objects do not fall and liquids are not spilled into the enclosure through openings. Do not expose this product to rain or moisture.
12. Refer all servicing to qualified service personnel. Servicing is required when the apparatus has been damaged in any way, such as if power supply cord or plug is damaged, liquid has been spilled or objects have fallen into the apparatus, or the apparatus has been exposed to rain or moisture, does not operate normally, or has been dropped.

NOTE: This equipment has been tested and found to comply with the limits for a Class B digital device, pursuant to part 15 of the FCC Rules. These limits are designed to provide reasonable protection against harmful interference in a residential installation. This equipment generates, uses, and can radiate radio frequency energy and, if not installed and used in accordance with the instructions, may cause harmful interference to radio communications. However, there is no guarantee that interference will not occur in a particular installation. If this equipment does cause harmful interference to radio or television reception, which can be determined by turning the equipment off and on, the user is encouraged to try to correct the interference by one or more of the following measures:

- Reorient or relocate the receiving antenna.
- Increase the separation between the equipment and receiver.
- Connect the equipment into an outlet on a circuit different from that to which the receiver is connected.
- Consult the dealer or an experienced radio/TV technician for help.

CAUTION: Please note that any changes or modifications made to this product not expressly approved by Moog Music Inc. could void the user's authority granted by the FCC to operate the equipment.

OPERATING CONDITIONS AND STORAGE

For optimal performance, you should use your Mavis between 50–95 degrees Fahrenheit (10–35 degrees Celsius). Safe operating conditions are within the range of 50–110 degrees Fahrenheit (10–43 degrees Celsius).

Mavis should be stored in temperatures above 32 degrees Fahrenheit (0 degrees Celsius) but never greater than 135 degrees Fahrenheit (57 degrees Celsius). Do not leave Mavis in a vehicle on a hot day with the windows closed. Temperatures in a vehicle can exceed 175 degrees Fahrenheit (80 degrees Celsius).

Table of Contents

8	Assembly Instructions
11	Setup & Connections
12	About Mavis Analog Synthesizer Basics
14	Meet Mavis Default Settings
15	Listening to Wave Shapes Listening to the Filter
16	Applying Modulation
17	Patching Examples Wave Folding S+H (Sample + Hold)
18	MULT Attenuator
19	ONE+TWO Mixer
20	Panel Controls & Functions 21 The Voltage Controlled Oscillator (VCO) 24 The Voltage Controlled Filter (VCF) 26 The Low Frequency Oscillator (LFO) 28 The Envelope Generator (EG) 30 The Voltage Controlled Amplifier (VCA) 31 The Keyboard 33 The Utilities (UTL)
35	The Patchbay
42	Patchbay Module Functions Wave Folding
43	The Mixer MULT
44	Attenuator Sample + Hold
45	Using Mavis as a Eurorack Module
46	Calibration
48	Signal Flow
49	Specifications
50	Warranty & Service Information

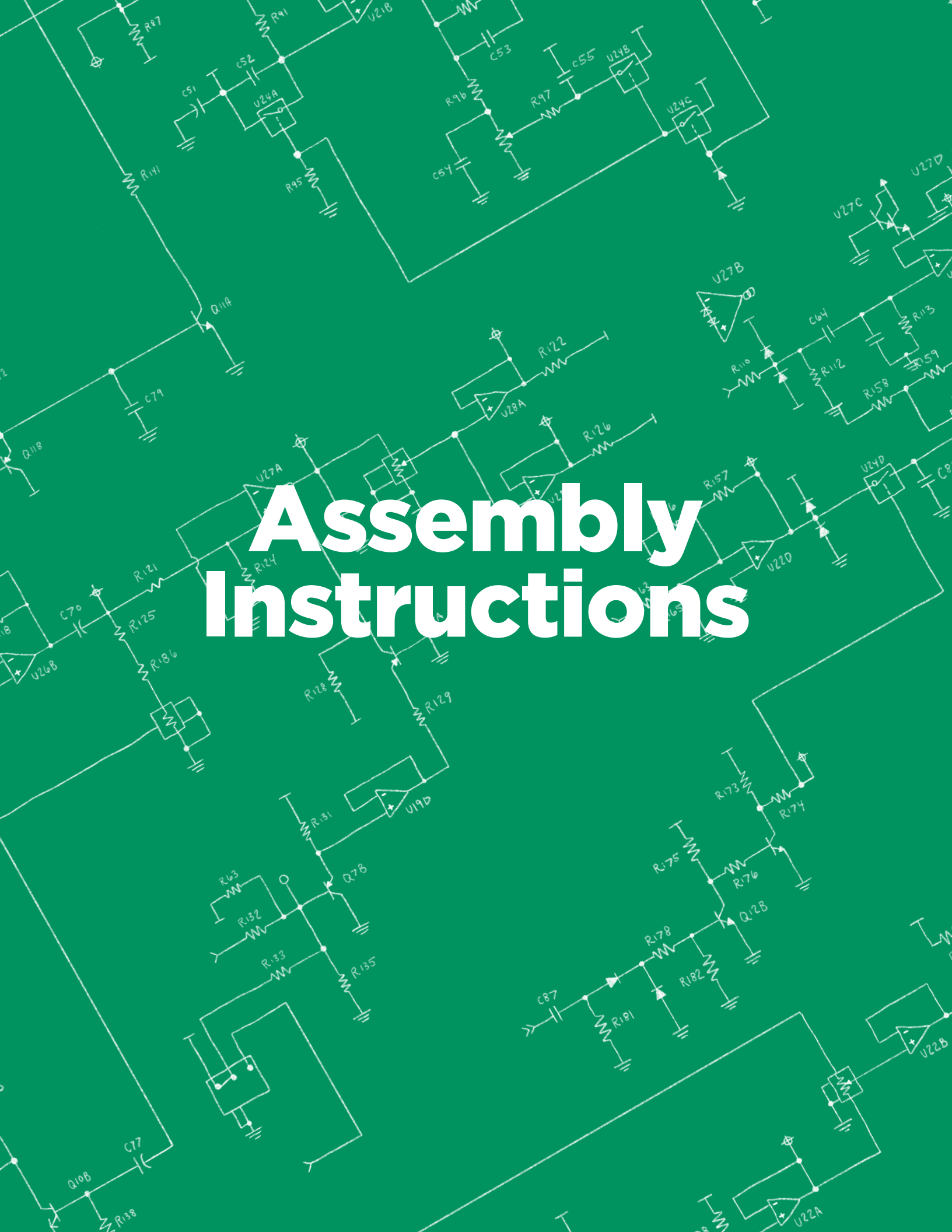

Assembly Instructions

Assembly Instructions

To learn how to assemble your new synth, visit moogmusic.com/mavis for video assembly instructions, follow the instructions on the included Quickstart and Assembly guide, or follow the instructions on the next few pages.

Putting Mavis together is easy. All of the electronic components have been pre-assembled, so no soldering is required. And while assembly is not complicated, it is important to follow each step, in order. Be mindful that you are working with delicate, high-tech electronics, so a good measure of caution and care is always in order.

A Note About Electrostatic Discharge: You may have noticed that little electric shock you sometimes receive when you touch something like a metal doorknob. This is called electrostatic discharge, and it can be harmful to electronic components. To protect the circuitry when you are assembling your Mavis, leave the circuit board in its protective anti-static sleeve until you are ready to install it. Also, take a moment to ground yourself by touching a metal surface or grounded object before you handle the circuit board.

Unpacking & Inspection

Check the contents of the shipping carton. Be careful when unpacking your new Moog Mavis parts so that nothing is lost or damaged. Moog recommends saving the carton and all packing materials in case you ever need to ship the instrument for any reason.

MAVIS SHIPS WITH THE FOLLOWING ITEMS:

1. Lid	x1
2. Chassis	x1
3. Front Panel	x1
4. PCB (Printed Circuit Board)	x1
5. Hex Nut Driver Tool	x1
6. Rubber Feet	x4
7. M3x8 Screws	x9 (+1 spare)
8. Hex Nuts	x24 (+1 spare)
9. Light Pipe	x1 (+1 spare)
10. Serial Number Label	x1
11. Calibration Tool	x1
12. 6" 3.5 mm Mono (TS) Patch Cables	x5
13. Mavis Quickstart and Assembly Guide	x1
14. 12 Volt DC Power Supply	x1

WHAT YOU WILL NEED:

1. A table or surface where you can assemble your Mavis
2. A Phillips Screwdriver
3. A 1/4" instrument cable and amplified speaker, or headphones with a 1/4" plug
4. A properly wired AC outlet (100-240 Volts AC/50-60 Hz)

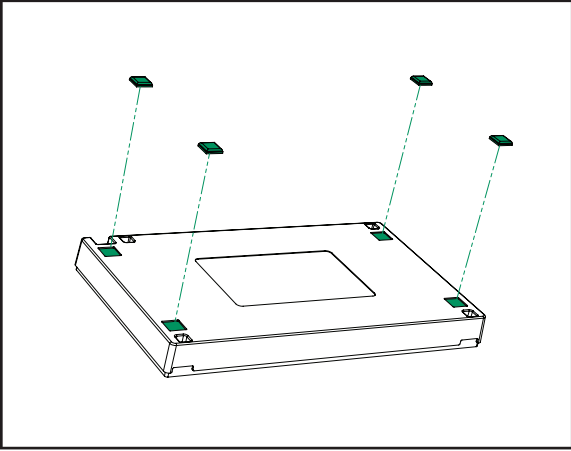

ATTACH THE FEET

The square self-adhesive **Rubber Feet** should be placed on the corresponding square areas on the bottom side of the **Chassis**.

Remove the protective film from each foot, apply, and hold firmly for a few seconds.

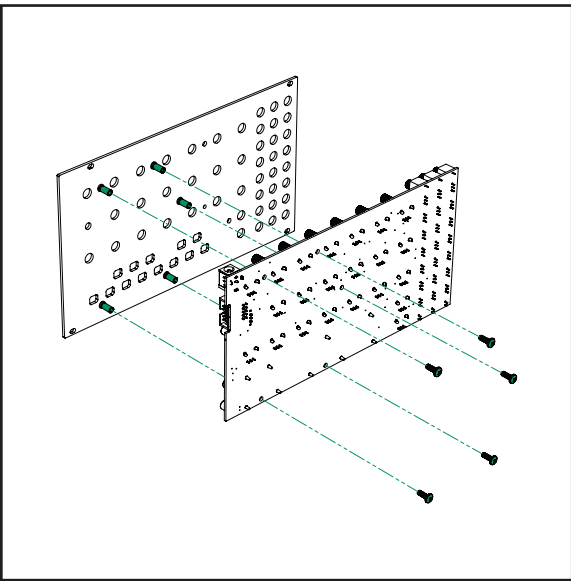

SECURE PCB TO FRONT PANEL

Carefully remove the **Printed Circuit Board (PCB)** from the sleeve. Gently guide the **Front Panel** onto the **PCB**, taking care that all keys, knobs, jacks, and the VCA switch fit through their respective holes. Using a **Phillips Screwdriver**, carefully secure the **PCB** to the **Front Panel** using five of the **M3x8 Screws**. These screws enter from the back of the **PCB** and attach to threaded stand-offs on the back of the **Front Panel**.

***NOTE:** A few of the rubber keys may not immediately pass through the **Front Panel**. For these remaining keys, simply use the flat end of the included red calibration tool to guide them into the correct position.*

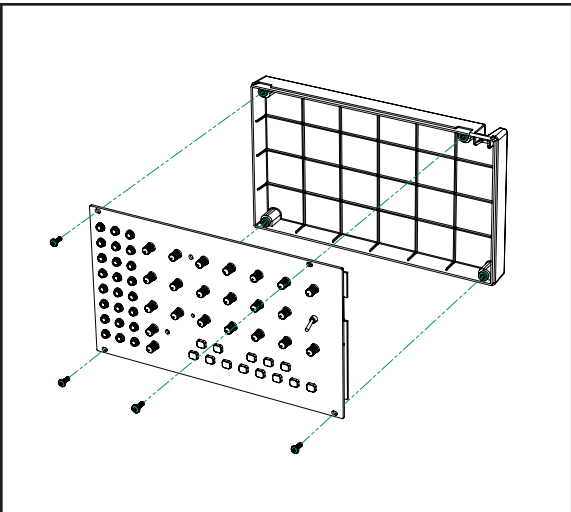

MOUNT PCB/PANEL ASSEMBLY TO THE CHASSIS

Place the **PCB/Panel Assembly** into the **Chassis**. Be sure that the power jack connection on the **PCB/Panel** lines up with the power jack port on the **Chassis**. Use the four remaining **M3x8 Screws** to mount the **PCB/Panel Assembly** to the **Chassis**.

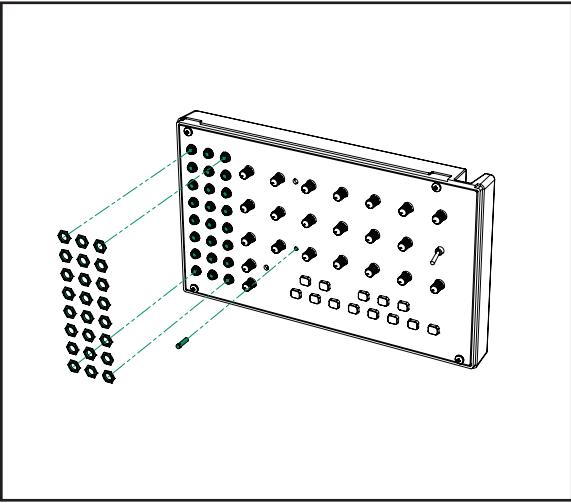

SECURE PATCHBAY AND INSTALL LIGHT PIPE

Use the 8mm end of the included **Hex Nut Driver** to secure a **Hex Nut** to each of the 24 jacks on the **Patchbay** (be careful not to over-torque). This will provide a secure platform for plugging and unplugging patch cables. Next, there is a clear plastic **Light Pipe** that carries light from the **LFO RATE LED** on the **PCB** to the **Front Panel**. Insert the tapered end of the **Light Pipe** into the hole directly to the right of the **LFO RATE** knob. When inserted correctly, it should sit nearly flush with the **Front Panel**.

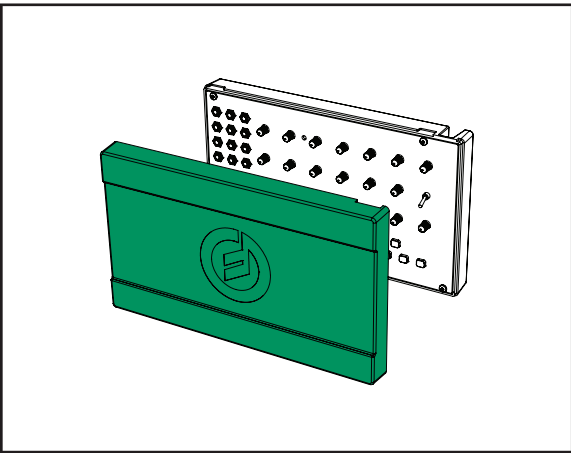

ATTACH THE LID

Mavis includes a protective **Lid** that keeps dust and debris off of your instrument. Place the **Lid** on top of Mavis when not in use, while in transit, and for the next assembly step.

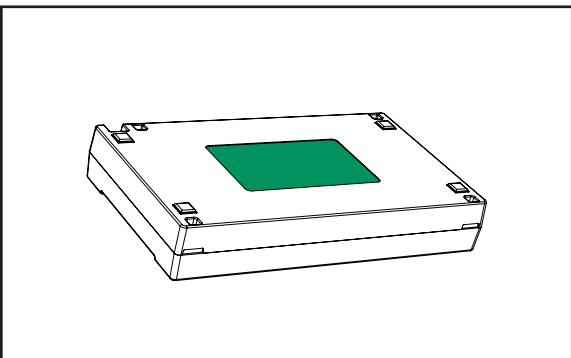

APPLY THE SERIAL NUMBER

Now that you've built your new instrument, it's time to make it official.

With the **Lid** on, flip the entire unit upside down and apply the **Serial Number Label** to the bottom of the **Chassis**. Don't forget to write your name in the "Built By" section.

Setup & Connections

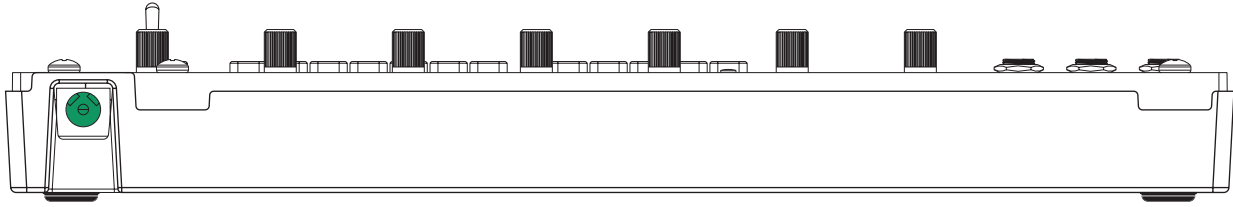

POWER UP & PLAY

Using the included **12V DC Power Supply**, connect the barrel end to the Mavis power connection jack, and connect the other end to an AC wall outlet (100–240 Volts AC/50–60 Hz).

When the red **LFO RATE LED** on the **Front Panel** lights up, your synthesizer is powered on and you are ready to build your first patch!

***NOTE:** If you do not see your **LFO RATE LED** light right away, try turning the **LFO RATE** knob and look for the increase and decrease in frequency.*

***NOTE:** There is no power switch on your Mavis. Once connected to the power supply, the unit is On. Mavis is an analog instrument and should be allowed to warm up before use. In cases where it has been left in a cold car overnight, for example, it may take even longer for the oscillator tuning to stabilize. For optimized tuning, do not operate your Mavis in direct sunlight.*

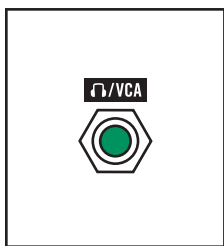

/VCA

With the Mavis **VOLUME** knob turned all the way down (counterclockwise), plug one end of a 3.5 mm cable into the /VCA jack on the patchbay. Then plug the other end into an amplified speaker or mixing console input, using a 3.5 mm-to-1/4" adapter if necessary. This jack can also be used with a set of mono or stereo headphones, providing the same signal to each ear. Now, raise the **VOLUME** knob (clockwise) to bring the sound to an appropriate level.

About Mavis

Mavis is a complete, compact, and powerfully equipped analog synthesizer. The built-in keyboard, select hardwired connections, and remarkable sound engine provide Mavis with plenty of musical dexterity to stand all on its own. On-board utilities and an array of inclusive patch points transform Mavis into the archetype of a modular synthesizer, able to work in concert with other modular, semi-modular, or Eurorack instruments and other electronic music equipment. Once assembled, you will have the satisfaction of owning a 100% analog Moog synthesizer that you've built yourself. A lifetime of rewarding synthesizer experiences await.

ANALOG SYNTHESIZER BASICS

Analog synthesis relies on two types of signals: audio signals and control signals. Audio signals are the sounds you hear emanating from the sound creation circuits of an instrument. Control signals, on the other hand, are used to change and/or modify the settings of these circuits. In an analog instrument, these control signals carry a continuously variable voltage level. These signals are referred to as Control Voltages, and many parameters of an analog synthesizer's modules are "Voltage Controlled." An additional type of control signal is known as a Gate, or Trigger, which is simply used to initiate an event. Pressing a key on a keyboard is an example of generating a Gate signal.

In an analog synthesizer, each set of circuits performs a particular job—the oscillators, filters, envelopes, etc.—are each self-contained modules. By design, these modules are wired together using both audio signals and control signals. However, patch points and patch cables can allow these modules to be reconnected in new ways. This is the basis for the term Modular Synthesizer. The first Moog synthesizers were modular synthesizers.

In this diagram of Mavis modules, the solid lines represent audio signals, and the dotted lines represent control signals. The definitions and functions of each module are described later in the ["Panel Controls & Functions"](#) section (page 20).

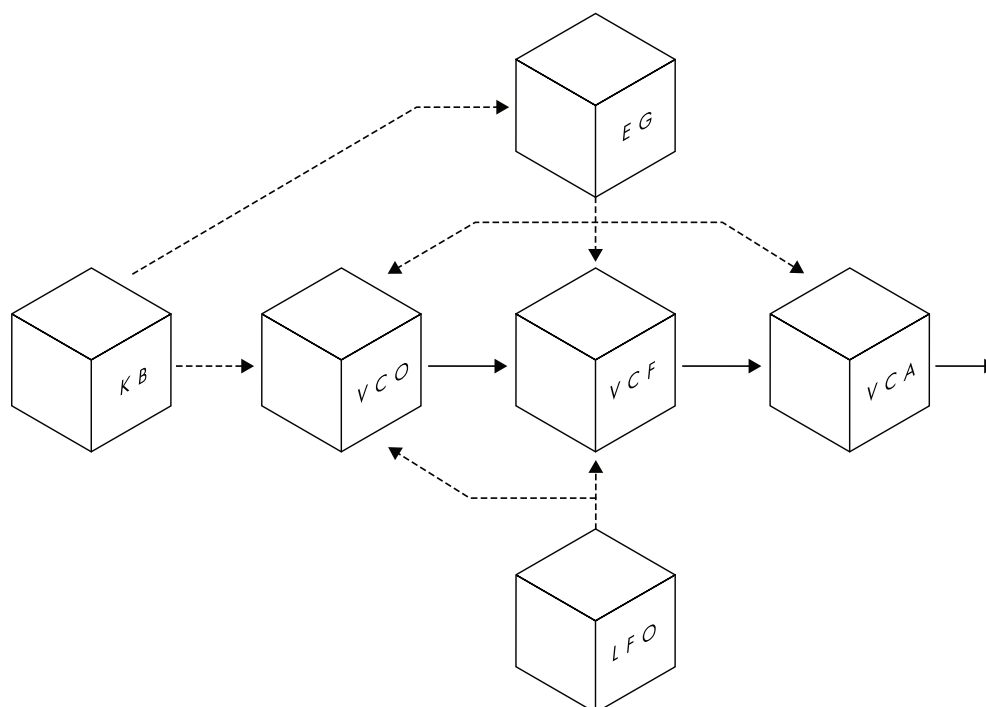

Meet Mavis

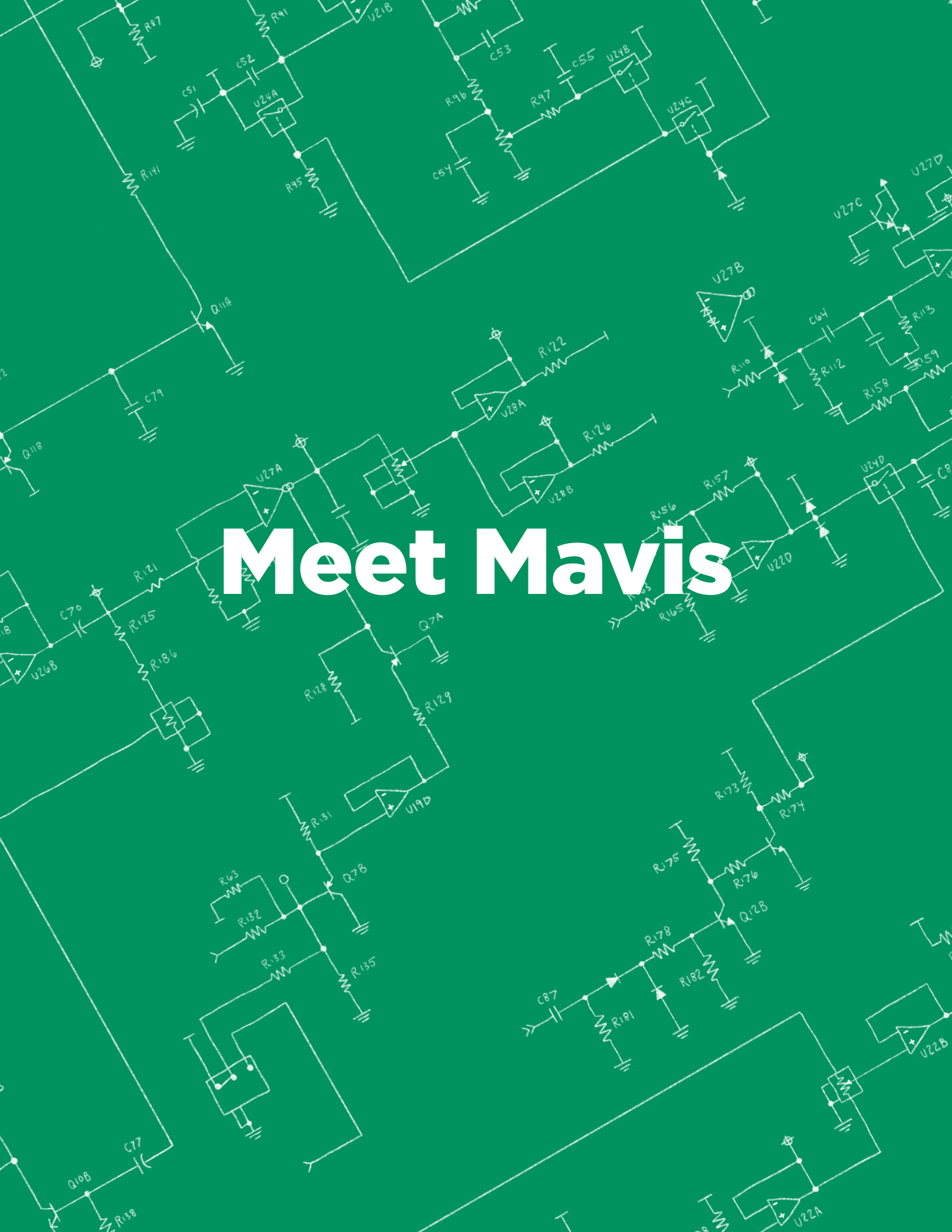

Meet Mavis

Mavis is jam-packed with analog synthesizer goodness and rich sonic character. The powerful Voltage Controlled Oscillator (**VCO**) is matched with a Voltage Controlled Filter (**VCF**) of the legendary Moog Ladder Filter design. Modulation sources like the Low Frequency Oscillator (**LFO**) and four-stage Envelope Generator (**EG**) add dynamic motion to your sound—and the full-octave button keyboard puts it all at your fingertips.

Deeper still, the Utilities (**UTL**) and patchbay are home to many more modular treats. Here you will find a wave folder, a 2-in/1-out mixer, a variable attenuator, modular mult jacks, and even a Sample + Hold (**S+H**) Generator. These same 24 patch points offer the freedom to connect the modules in new and creative ways, and to explore the excitement of interfacing with other synths and electronic music equipment.

DEFAULT SETTINGS

Now that your Mavis is assembled and fully functional, here are a couple of quick exercises that allow you to become more familiar with how it works. Be sure that Mavis is connected to an AC power source using the included adapter, and connect a set of headphones to the **⏏/VCA** output jack. This same jack can also be used to connect Mavis to an amplifier, monitoring system, audio interface, etc. Carefully set all of the controls to the default positions shown below. This will provide a great starting point for exploring the functions and features of Mavis.

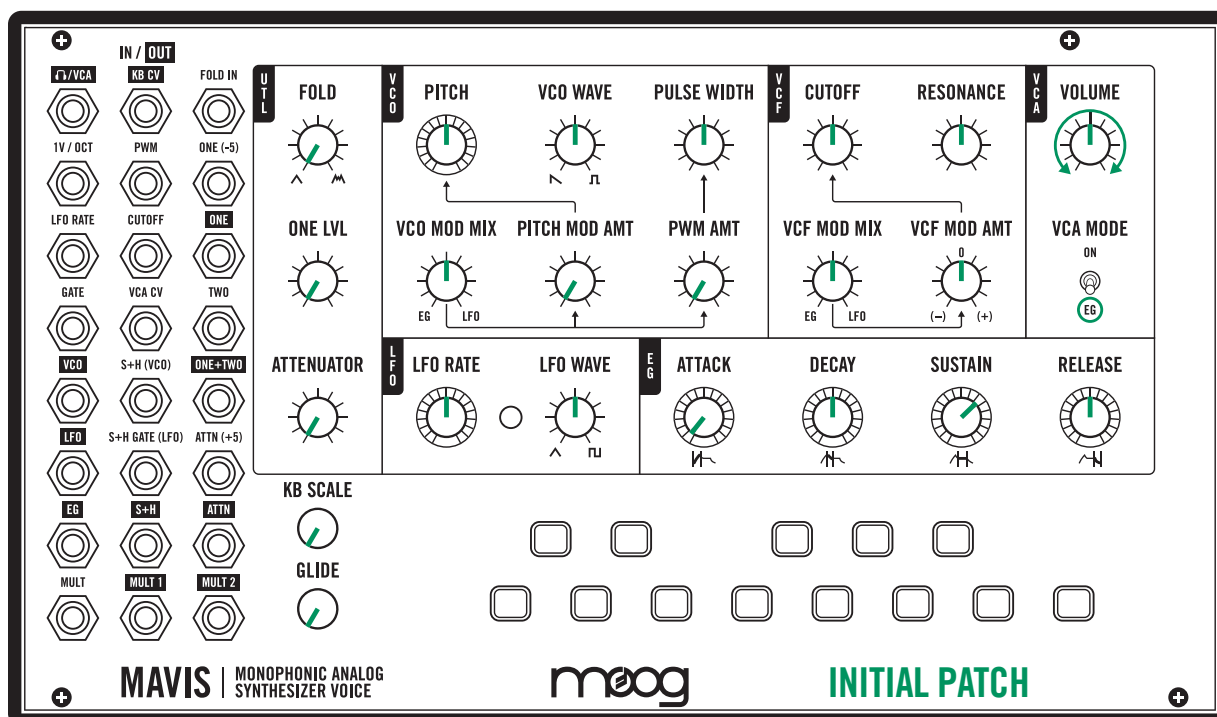

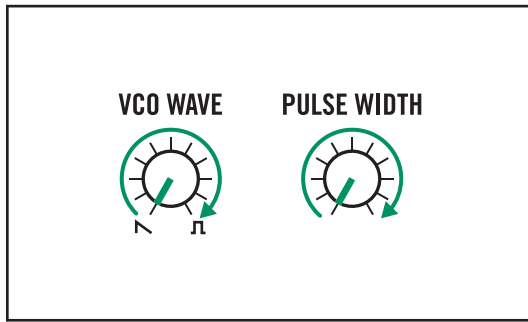

LISTENING TO WAVE SHAPES

Timbre is a term used to denote the harmonic content of a sound, be it bright and buzzy or warm and dark. In general, timbre is defined by two things: the waveform of the oscillator and the settings of the filter. Using the default settings, hold down any key on the keyboard. Slowly rotate the **VCO WAVE** knob from the fully counterclockwise position (saw) to the fully clockwise position (pulse), and listen to how the harmonic composition of the sound changes.

Leave the **VCO WAVE** knob in the fully clockwise position. This selects the Pulse wave. Now, slowly rotate the **PULSE WIDTH** knob. This changes the width, or duty cycle, of the Pulse wave, from a narrow pulse (counterclockwise) to a square wave (clockwise). These two knobs provide a wide variety of timbres.

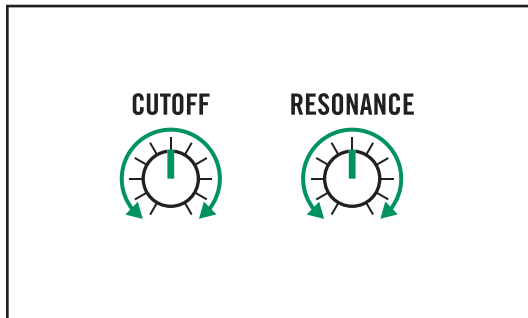

LISTENING TO THE FILTER

Mavis is equipped with a low-pass audio filter to further shape the timbre of your sound. The **CUTOFF** knob sets the frequency of the filter. Simply put, sonic frequencies above the Cutoff frequency are filtered out, and the sounds below the Cutoff frequency are allowed to pass.

The **RESONANCE** knob adds a certain amount of boost, or emphasis, to frequencies around the Cutoff. Return all the knobs to their [default settings](#) (page 14). Again, hold any key on the keyboard and slowly rotate the **CUTOFF** knob. As the knob is rotated to the left (counterclockwise), you will hear the sound get “darker” as more upper harmonic content is filtered out. Rotating this knob to the right (clockwise) allows more upper harmonic content to pass through the filter, creating a “brighter” sound.

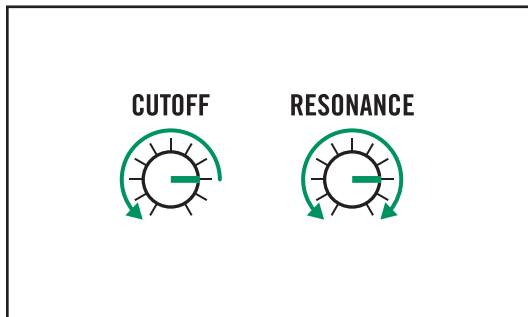

Now try different settings of the **RESONANCE** and **CUTOFF** knobs, noticing how it affects your sound. Finally, set both the **CUTOFF** and the **RESONANCE** knobs to about the 3 o'clock position, and slowly rotate the **CUTOFF** knob to the left (counterclockwise). As you “sweep” the filter in this manner, you will hear the emphasis peak created by the **RESONANCE** knob sweep as well. At maximum Resonance settings, the filter will self-oscillate, producing its own audible tone. Setting the filter to self-oscillate is a useful synthesis trick for adding sonic complexity to your sound.

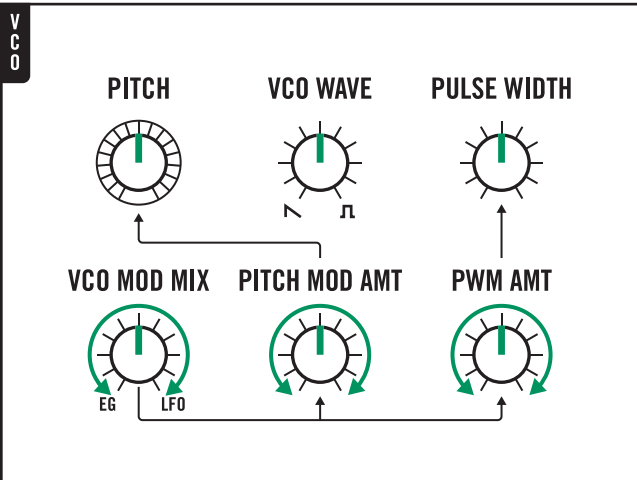

APPLYING MODULATION

In the previous exercises, manually changing the settings of the **PULSE WIDTH** knob and the **CUTOFF** knob noticeably affected the sound. In a voltage-controlled analog synthesizer such as Mavis, we can apply a modulation source (Control Voltage) to automatically change the value of these parameters. Mavis contains two hardwired modulation sources. The first is an **LFO** (Low Frequency Oscillator) that provides a repeating, cyclic change based on the current settings of the **LFO RATE** and **LFO WAVE** parameters. The second is the **EG** (Envelope Generator) that creates a single, continuously changing control signal based on the current settings of the **ATTACK**, **DECAY**, **SUSTAIN**, and **RELEASE** knobs. This EG control signal begins anew each time a key is pressed.

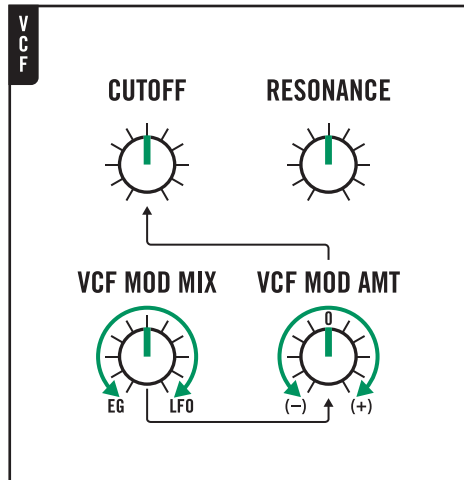

Rotating the **VCO MOD MIX** knob selects the **EG**, the **LFO**, or some mix of these two modulation sources. The **PITCH MOD AMT** knob determines how much of this combined modulation source is being applied to the pitch of the **VCO**. The **PWM AMT** knob determines how much of this combined modulation source is being applied to the Pulse Width of the **VCO** wave shape. Go ahead and try rotating these three knobs and hear how it affects the sound.

Similar controls are available to automatically modulate the Cutoff frequency of the **VCF**. Rotating the **VCF MOD MIX** knob selects the **EG**, the **LFO**, or some mix of these two modulation sources. The **VCF MOD AMT** knob determines how much of this combined modulation source is being applied to the Cutoff frequency of the **VCF**. Again, go ahead and rotate these two knobs to hear how it will affect the sound.

Patching Examples

Throughout this manual, individual patch points are referenced by their label name, and by their Row and Column coordinates, such as (R4; C2) for the **VCA CV** input jack.

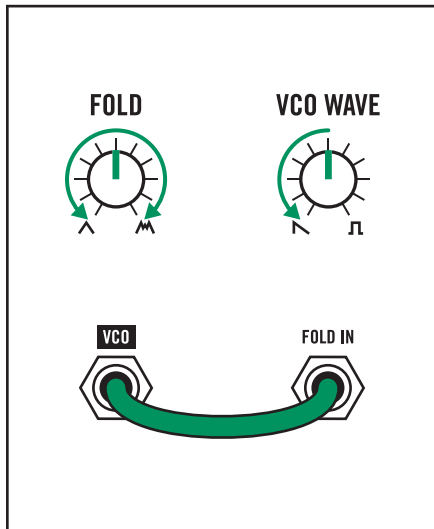

WAVE FOLDING

Wave Folding is another concept available in your Mavis to change the harmonic content of the sound, and Mavis is the first Moog instrument to ever feature a wave folder. The wave folder is not part of the Mavis signal chain by default, and must be patched in to use.

Patching any signal to the **FOLD IN** input jack (R1; C3) will connect that signal directly through the wave folder to the **VCF** and **VCA**, bypassing the **VCO**. In order to try this out, return all of the parameters to their **default settings** (page 14) and rotate **VCO WAVE** fully counterclockwise to the saw wave. Next, connect a patch cable from the **VCO** output jack (R5; C1) to the **FOLD IN** input jack.

As you hold down any key on the keyboard, slowly rotate the **FOLD** knob back and forth between the full left (counterclockwise) and full right (clockwise) position to hear how controlling the amount of wave folding affects the timbre of the sound. Generally, rotating the **FOLD** knob to the right will add a more aggressive sound. To the left, not so much.

*TIP: Due to the way Wave Folding handles sharper wave edges, the wavefolder will have a much more pronounced effect with the **VCO WAVE** knob set to saw than set to square.*

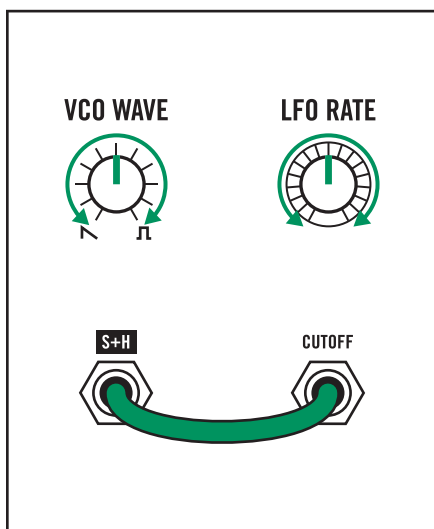

S+H (Sample + Hold)

Sample + Hold is a specialized form of modulation that creates a series of stepped voltages that can be applied to change the value of a specific parameter. For a deeper discussion of how the Sample + Hold circuit works, see "**Sample + Hold**" (page 44). This example will use **S+H** to change the value of the **VCF** Cutoff frequency.

First, set all of the parameters back to their **default settings** (page 14). Next, connect a patch cable from the **S+H** output jack (R7; C2) to the **CUTOFF** input jack (R3; C2).

As you hold down any key on the keyboard, you will hear the note sustain, but it will seem to "pulse" as the value of Cutoff frequency changes in a rhythmic fashion. Try turning the **VCO WAVE** knob and the **LFO RATE** knob to hear how the **S+H** effect changes.

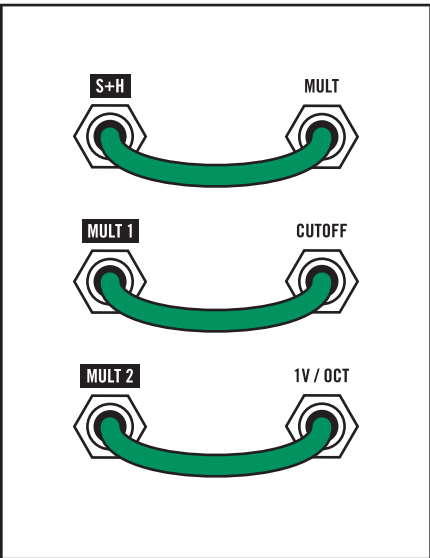

MULT

The **MULT** is a simple module that allows you to route one signal to two different destinations. Continuing from the **SAMPLE + HOLD** example above, you may want to route the **S+H** effect to change the frequency of the **VCO** in addition to the filter cutoff. Patch the **S+H** output jack (R7; C2) to the **MULT** input jack (R8; C1).

By patching the **MULT 1** output jack (R8; C2) to the filter **CUTOFF** input jack (R3; C2) we can replicate the example from the previous section while having another copy of the Sample + Hold signal available at the **MULT 2** output jack (R8; C3).

Patch the **MULT 2** output jack (R8; C3) to the **1V/OCT** input jack (R2; C1) to have the Sample + Hold change both the pitch and filter cutoff frequency at the same time.

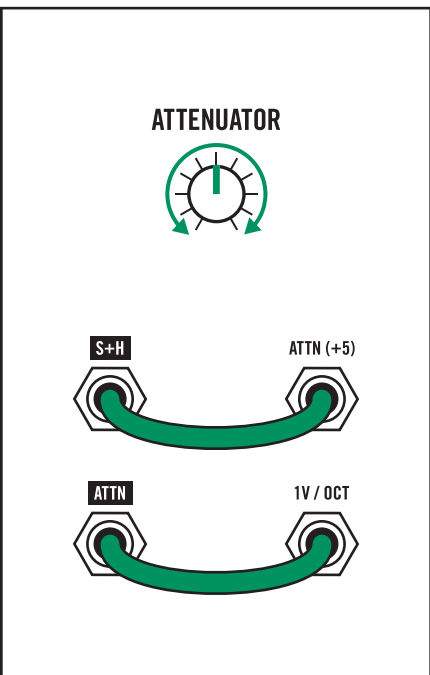

ATTENUATOR

The **ATTENUATOR** is another simple module that allows you to adjust the strength of any signal. Perhaps we want to use the Sample + Hold to change the **VCO** frequency but would like a less dramatic effect.

Patch the **S+H** output jack (R7; C2) to the **ATTN (+5)** input jack (R6; C3) and patch the **ATTN** output (R7; C3) to the **1V/OCT** input jack (R2; C1).

With this configuration, you can use the **ATTENUATOR** knob to scale the Sample + Hold effect on the **VCO**—from narrow, subtle changes with the knob counter clockwise to wider range changes as the knob is turned clockwise.

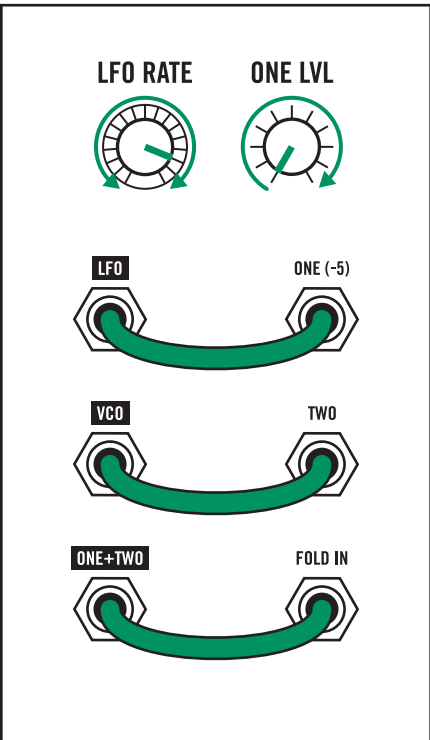

ONE+TWO MIXER (LFO as second oscillator)

Mavis includes a mixer that allows you to mix a signal through the **ONE** input jack (R3; C3) and associated **ONE LVL** knob with a signal in the **TWO** input jack (R4; C3).

One of the most powerful uses of this mixer is to turn Mavis into a two-oscillator synthesizer by using the **LFO** at audio rate. To explore this, begin by returning all parameters to their [default settings](#) (page 14).

First, put the **LFO** into audio rate by moving the **LFO RATE** knob to approximately 4 o'clock. Next, patch the **LFO** output jack (R6; C1) to the **ONE (-5)** input jack (R2; C3), patch the **VCO** output jack (R5; C1) to the **TWO** input jack (R4; C3) and patch the **ONE+TWO** output jack (R5; C3) to the **FOLD IN** input jack (R1; C3).

As you hold down the low C key, raise the level of the **ONE LVL** knob to hear both the **LFO** and **VCO** mixed together, and adjust the **LFO RATE** knob slowly until both oscillators are close enough together to provide a pleasing, thick sound.

As you play the keyboard, you will hear the **VCO** move in tandem with the keys while the **LFO** remains at the pitch corresponding to C, providing a nice tonal counterpoint.

By patching the **KB CV** output jack (R1; C2) to the **LFO RATE** input jack (R3; C1) both oscillators will move together. This patch offers a deep timbral world to play with by adjusting the **VCO WAVE**, **LFO WAVE**, and **ONE LVL** knobs while also allowing for wave folding on top.

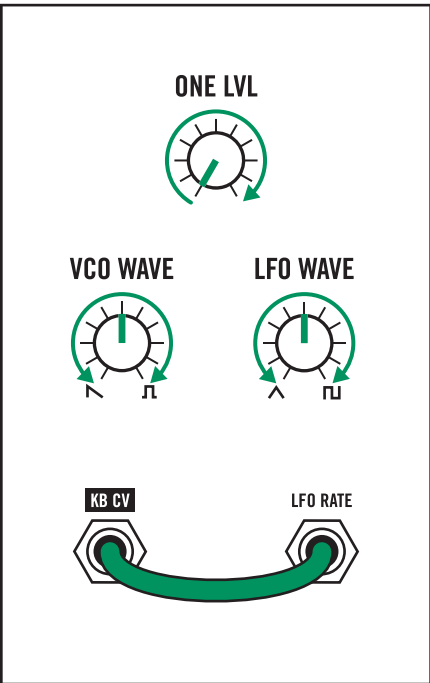



Panel Controls & Functions

The Voltage Controlled Oscillator (VCO)

Sound begins with an object moving back and forth; this could be a guitar string, a clarinet reed, the vocal cords, or—in the case of a synthesizer—an Oscillator. Mavis uses a single Voltage Controlled Oscillator (**VCO**) to generate sound. The top row of knobs control Oscillator parameters related to pitch and timbre; the second row of knobs are used to apply modulation to those Oscillator parameters.

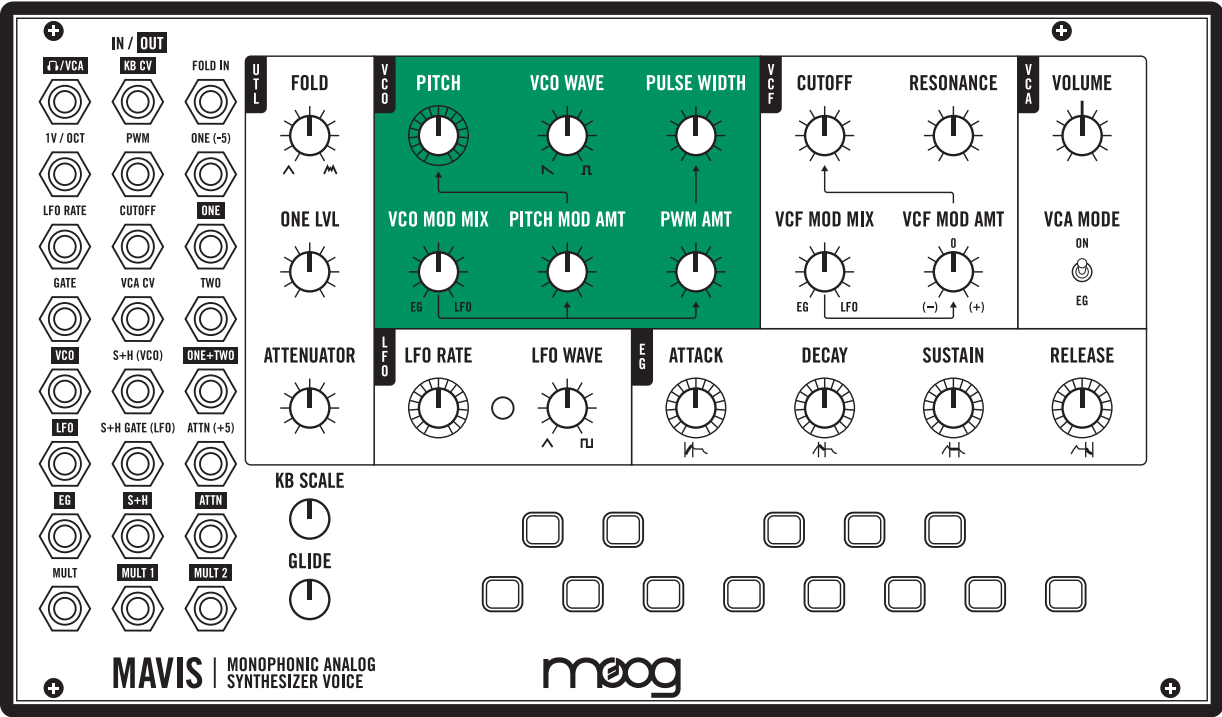

OSCILLATOR PARAMETERS

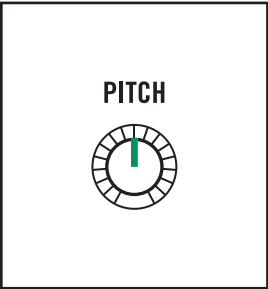

PITCH

The **PITCH** knob sets the initial frequency of the Oscillator, thereby setting the pitch. Rotating the knob counterclockwise lowers the Pitch, while rotating the knob clockwise raises the Pitch. While holding down the lowest C on the keyboard, the value can be set from 8 Hz (fully counterclockwise) to 8 kHz (fully clockwise).

***NOTE:** We think of human hearing as being roughly between 20 Hz–20 kHz, so 8 Hz is pretty darn low, and may not be audible as more than a series of clicks.*

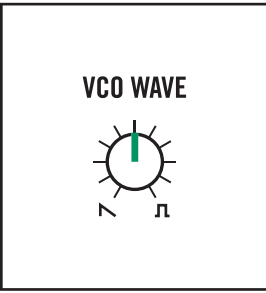

VCO WAVE (Oscillator Wave Shape)

Each wave shape has its own particular timbre, based on its harmonic content. Mavis allows you to select a **SAW** wave, a **PULSE** wave, or any mix of these two waves using the **VCO WAVE** knob. Rotating this knob fully counterclockwise will create a Saw wave, and rotating this knob fully clockwise will create a Pulse wave. Setting the **VCO WAVE** knob anywhere in between its two extremes will combine the **SAW** and **PULSE** wave shapes, providing a versatile harmonic palette for your sound design excursions.

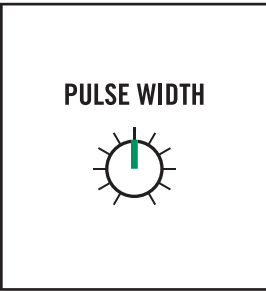

PULSE WIDTH

The Pulse wave is unique, in that changing its width (duty cycle) will also affect its harmonic content, and thus its timbre. To hear this effect, start with the **VCO WAVE** knob in the fully clockwise position, so that you are listening to the Pulse wave alone. Rotating the **PULSE WIDTH** knob fully counterclockwise will create a tightly narrow Pulse wave with a sharper, and more nasal sound. Rotating the **PULSE WIDTH** knob fully clockwise will create a square wave with a smoother, more even sound.

TIP: Listen as you rotate this knob back and forth. What you are hearing is Pulse Width Modulation. In the next section, we will show how the Pulse Width can be modulated automatically.

OSCILLATOR MODULATION PARAMETERS

In a voltage-controlled analog synthesizer such as Mavis, a modulation source (Control Voltage) can be applied to automatically change the value of chosen parameters. Mavis contains two modulation sources. The first is an **LFO** (Low Frequency Oscillator) that provides a repeating, cyclic change based on the current settings of the **LFO RATE** and **LFO WAVE** parameters. The second is the **EG** (Envelope Generator) that creates a one-shot, continuously changing control signal based on the current settings of the **ATTACK**, **DECAY**, **SUSTAIN**, and **RELEASE** knobs. This **EG** control signal begins anew each time a key is pressed or an external Gate is received.

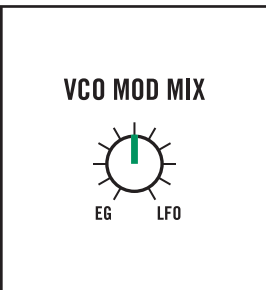

VCO MOD MIX (Voltage Controlled Oscillator Modulation Mix)

Mavis allows both modulation sources to be applied to certain Oscillator parameters at once. Use this knob to set the balance between the two modulation sources (**LFO** and **EG**). Rotating this knob fully counterclockwise will select only the **EG** as the modulation source. Rotating this knob fully clockwise will select only the **LFO** as the modulation source. In between those two extremes, the **VCO MOD MIX** knob acts as a balance, or crossfader, control between these two modulation sources.

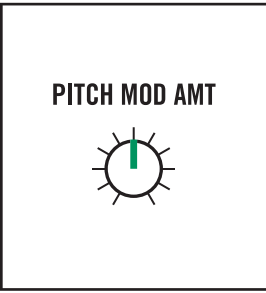

PITCH MOD AMT (Pitch Modulation Amount)

This knob determines the amount of modulation being applied to the **PITCH** parameter. The shape of this modulation is determined by the position of the **VCO MOD MIX** knob. Rotate the **PITCH MOD AMT** knob clockwise to increase the amount of modulation being applied to the **PITCH** parameter. Rotate the **PITCH MOD AMT** knob counterclockwise to reduce the amount of modulation being applied to the **PITCH** parameter.

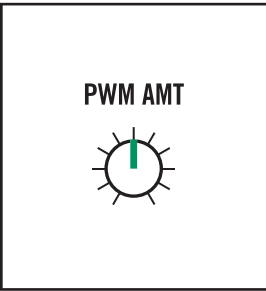

PWM AMT (Pulse Width Modulation Amount)

This knob determines the amount of modulation being applied to the **PULSE WIDTH** parameter. The shape of this modulation is determined by the position of the **VCO MOD MIX** knob. Rotate the **PWM AMT** knob clockwise to increase the amount of modulation being applied to the **PULSE WIDTH** parameter. Rotate the **PWM AMT** knob counterclockwise to reduce the amount of modulation being applied to the **PULSE WIDTH** parameter.

***TIP:** Pulse Width Modulation is a tried-and-true technique for creating motion and adding texture to a sound and is often used as the foundation for many string and pad types of sounds.*

The Voltage Controlled Filter (VCF)

Mavis utilizes a low-pass audio filter that selectively removes harmonic content to modify the timbre of your sound. Unlike selecting a wave shape, where timbre is determined based on individual harmonics that make up the wave, the Voltage Controlled Filter (**VCF**) changes the timbre by blocking certain frequencies of the overall sound, or by allowing them to pass, and also by adding resonance. The top row of knobs controls the Filter parameters; the second row of knobs are used to apply modulation to the Cutoff frequency.

***NOTE:** The Filter is of the classic 4-Pole Moog Ladder design, providing -24 dB of attenuation (per octave) to harmonic content above the Cutoff frequency.*

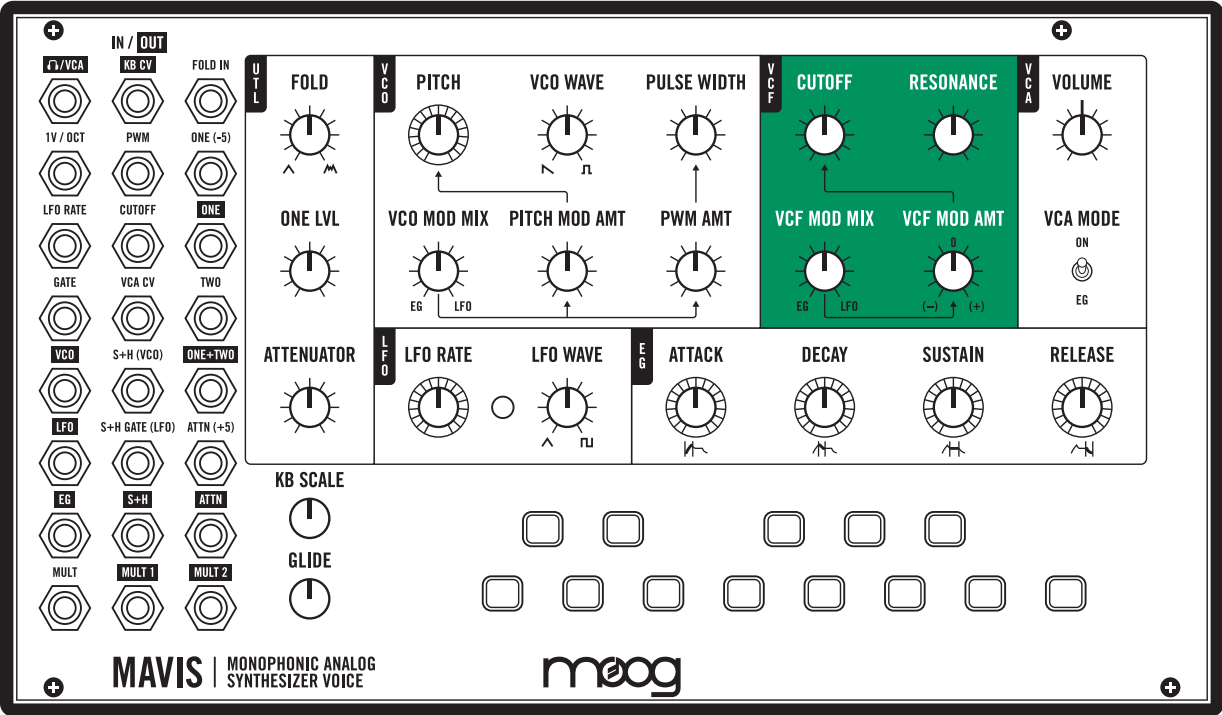

FILTER PARAMETERS

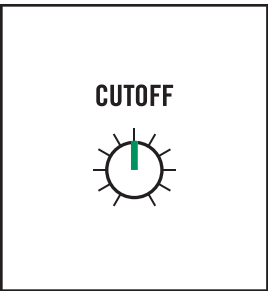

CUTOFF (Cutoff Frequency)

This knob sets the value of the Filter's Cutoff frequency, from 30 Hz–20 kHz. Simply put, harmonic content above this Cutoff frequency is filtered out, and the harmonic content below this Cutoff frequency is allowed to pass.

As the knob is rotated counterclockwise, the sound gets “darker” as more upper register components are filtered out. Rotating this knob clockwise allows more upper harmonic content to pass, creating a “brighter” sound.



RESONANCE

Also known as Emphasis, or Q, **RESONANCE** takes a portion of the Filter output and channels it back to the input of the Filter. This creates a resonant peak, or boost, that occurs at the Cutoff frequency. Rotating the **RESONANCE** knob clockwise will increase this resonant peak; rotating the knob counterclockwise will decrease the amount of this resonant peak. At maximum Resonance settings, the **VCF** can become self-oscillating. As modulation is applied to the Cutoff frequency, the relationship between Cutoff and Resonance can be heard with more clarity.

FILTER MODULATION PARAMETERS

As with Oscillator Modulation, Mavis contains two modulation sources that can be applied to vary the Cutoff frequency of the Filter. The first is the **LFO** (Low Frequency Oscillator). This provides a repeating, cyclic change based on the current settings of the **LFO RATE** and **LFO WAVE** parameters. The second is the **EG** (Envelope Generator). This creates a one-shot, continuously changing control signal based on the current settings of the **ATTACK**, **DECAY**, **SUSTAIN**, and **RELEASE** knobs. In this case, **EG** modulation can be used to add articulation to each note as it is played, or to create other dramatic modulation sweeps. This **EG** control signal begins anew each time a key is pressed or an external Gate is received.

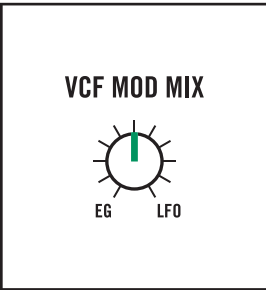

VCF MOD MIX (Voltage Controlled Filter Modulation Mix)

Mavis allows both modulation sources to be applied to the value of the Cutoff frequency parameter simultaneously. The **VCF MOD MIX** knob sets the balance between the two modulation sources (**LFO** and **EG**). Rotating this knob fully counterclockwise will select only the **EG** as the modulation source. Rotating this knob fully clockwise will select only the **LFO** as the modulation source. In between those two extremes, the **VCF MOD MIX** knob acts as a balance control, or crossfader, between these two modulation sources.

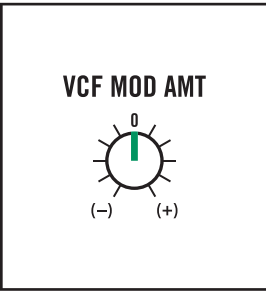

VCF MOD AMT (Voltage Controlled Filter Modulation Amount)

This knob determines the amount of modulation being applied to the Cutoff frequency. Unlike any of the other Mavis knobs, this control is bi-polar. In the center position, no modulation is being applied; the modulation amount is zero. Turning the knob clockwise from the zero point will add more and more modulation to the Cutoff frequency parameter. Turning this knob counterclockwise from the zero point will still add more and more modulation to the value of Cutoff frequency parameter, however, this modulation will have an inverse value. For example, instead of the **EG ATTACK** parameter raising the Cutoff frequency over time, as with a positive **VCF MOD AMT** value, the **EG ATTACK** parameter would instead lower the Cutoff frequency over time when a negative **VCF MOD AMT** value is chosen.

The Low Frequency Oscillator (LFO)

The Low Frequency Oscillator (**LFO**) creates a consistent modulation source that can be used to add a repeating, cyclical change to any of parameter that can be modulated—**VCO PITCH**, **VCO PULSE WIDTH**, **VCF CUTOFF**, etc. Using the Patchbay, you can also use the **LFO** as a second oscillator, or to modulate other parameters, such as the **VCA VOLUME** level.

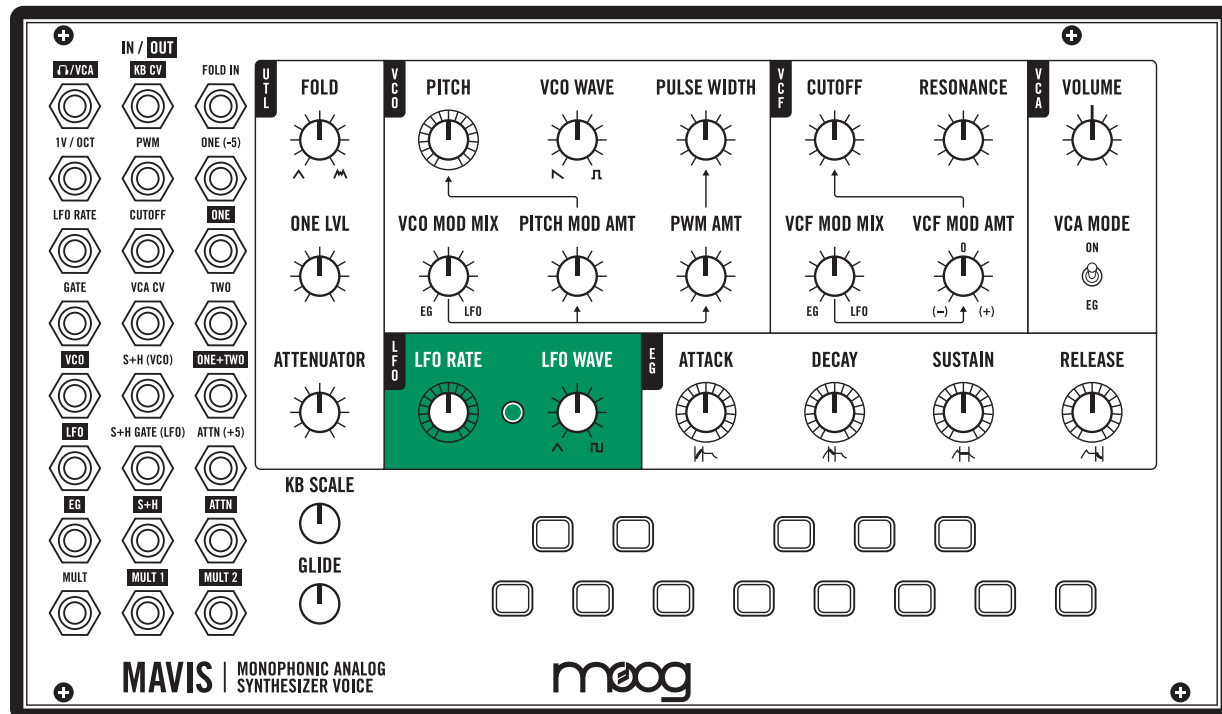

LFO PARAMETERS

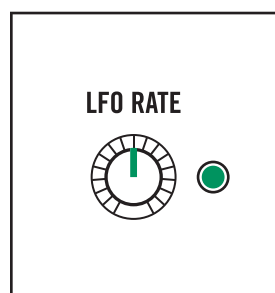

LFO RATE

The **LFO RATE** knob sets the cycle speed, or frequency, of the **LFO**. Rotating this knob clockwise will increase the **LFO RATE**; the maximum value is roughly 550 Hz. Rotating this knob counterclockwise will decrease the **LFO RATE**; the minimum value is about 0.1 Hz. The red LED will flash once for every wave cycle, providing visual feedback of the **LFO** speed.

*TIP: The Mavis LFO has an upper frequency of around 550 Hz—well within the audio range. This ability allows the LFO to be used as an audio source, but also to create rich and unusual sounds when modulating the **VCO PITCH** or other parameters.*

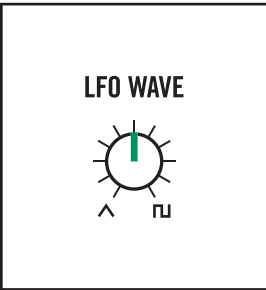

LFO WAVE (LFO Wave Shape)

The Mavis **LFO** creates two distinct wave shapes—triangle and square. This knob allows you to mix these two waves together to create a greater variety of modulation waves. Rotating the knob to the full clockwise position selects the square wave. The square wave alternates between two distinct values, one created at the top (crest) of the wave, and one created at the bottom (trough) of the wave. Tremolo and imitative trills are good examples of square wave modulation.

Rotating the knob to the full counterclockwise position selects the triangle wave. The triangle wave creates a continuously changing value that sweeps between the upper and lower limits of the wave. Vibrato is good example of a triangle wave modulation, where the **LFO** is applied to the **VCO PITCH** parameter. In between these two extremes, you can create a blend of these two options to create new modulation wave shapes.

The Envelope Generator (EG)

The four stages of an Envelope Generator—Attack, Decay, Sustain, and Release—combine to create one continuous control voltage that changes over time. By default, the **EG** modulates the **VCA**, articulating the amplitude of your sound every time a key is pressed.

Via the patchbay, this control voltage can also be used as a modulation source to control other parameters. For example, modulating the **VCF** Cutoff frequency to articulate the filter or modulating the **PWM** amount to add timbral motion. The **EG** begins its cycle every time a key is pressed (or when an appropriate voltage is received at the **GATE** jack). Three of the **EG** parameters are defined in terms of time. Only one—Sustain—relates to level.

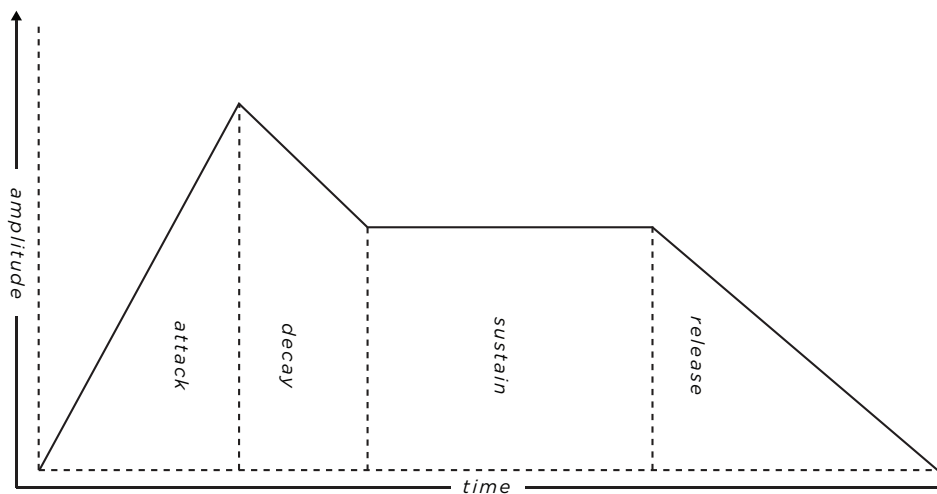
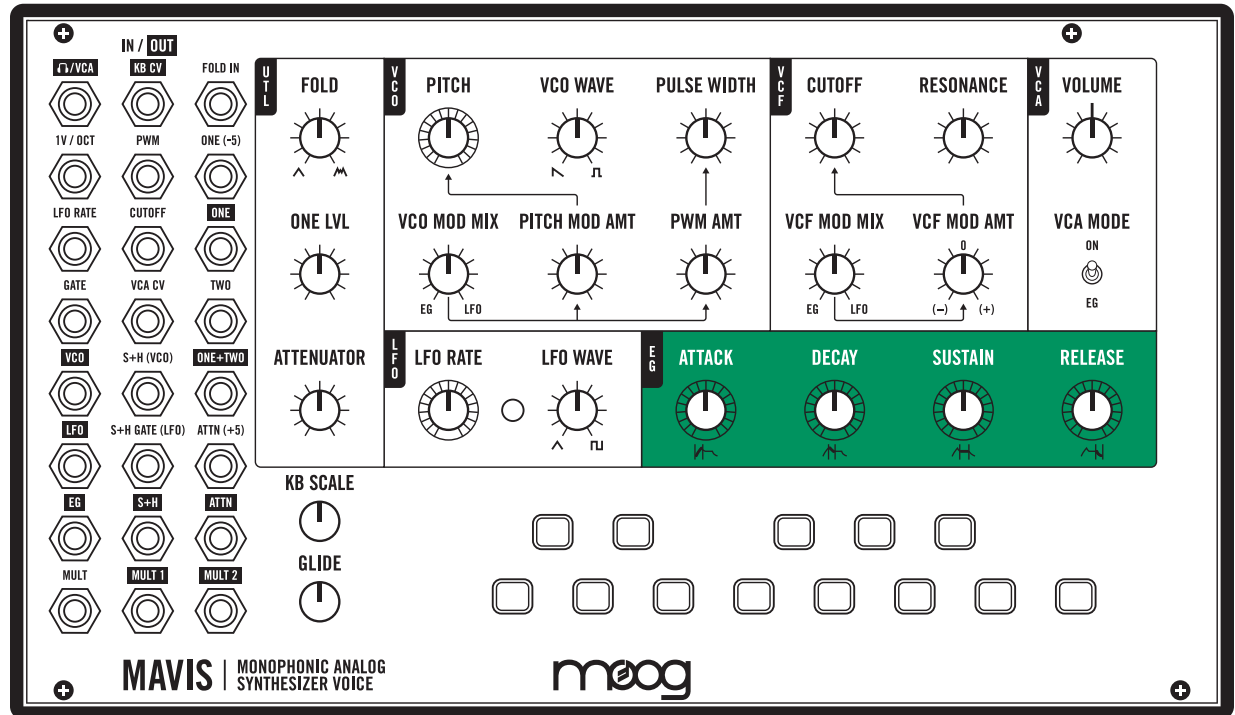

*NOTE: This diagram shows how all four stages of the **EG** work together.*

ENVELOPE PARAMETERS

TIP: In order to explore the EG controls, be sure the VCA MODE switch is set to EG. Press any key on the keyboard to trigger new envelopes as you explore different settings of these parameters.

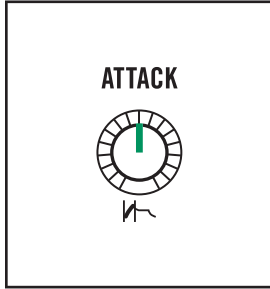

ATTACK (Attack Time)

The **ATTACK** knob determines the amount of time required for the control signal to rise from zero to its maximum level once a key is pressed. Rotating this knob counterclockwise will create a faster Attack time (0.8 ms minimum.) Rotating this knob clockwise will create a slower Attack time (5.5 seconds maximum). Faster attacks are useful for creating plucked sounds, while slower attacks are more useful for creating bowed string sounds and swells.

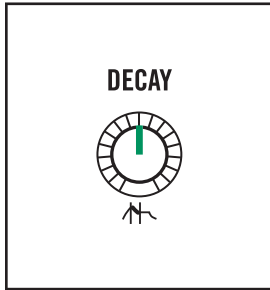

DECAY (Decay Time)

The **DECAY** knob determines the amount of time required for the control signal to fall from the maximum level achieved by the Attack stage to the Sustain level, while a key is being held. Rotating this knob counterclockwise will create a shorter Decay time (3.0 ms minimum.) Rotating this knob clockwise will create a longer Decay time (18 seconds maximum). Short decay times are useful for creating articulated lead notes, while longer decay times allow a note to fade slowly into the Sustain level.

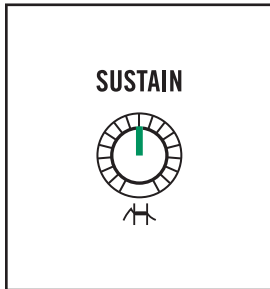

SUSTAIN (Sustain Level)

The **SUSTAIN** knob is unique, in that it determines a level, not an amount of time. Once the Attack and Decay stages are complete, the control signal will remain at the level set by the **SUSTAIN** knob for as long as a key is held. Rotating this knob counterclockwise will provide a lower sustain level. Rotating this knob clockwise will create a higher sustain level. The range of this Sustain level—in terms of control voltage—extends from 0 V–8 V.

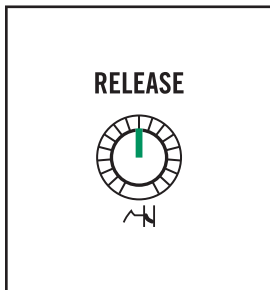

RELEASE (Release Time)

The **RELEASE** knob determines the amount of time required for the control signal to fall from its Sustain level to zero once a key is released. Rotating this knob counterclockwise will create a shorter Release time (3.0 ms minimum.) Rotating this knob clockwise will create a longer Release time (18 seconds maximum). Shorter settings are good for classic funk basses that end abruptly, while longer settings are good for creating smooth musical tails that ring out over time.

The Voltage Controlled Amplifier (VCA)

The Voltage Controlled Amplifier (**VCA**) module boosts the final audio signal to a suitable level for monitoring, recording, listening, interfacing, etc.

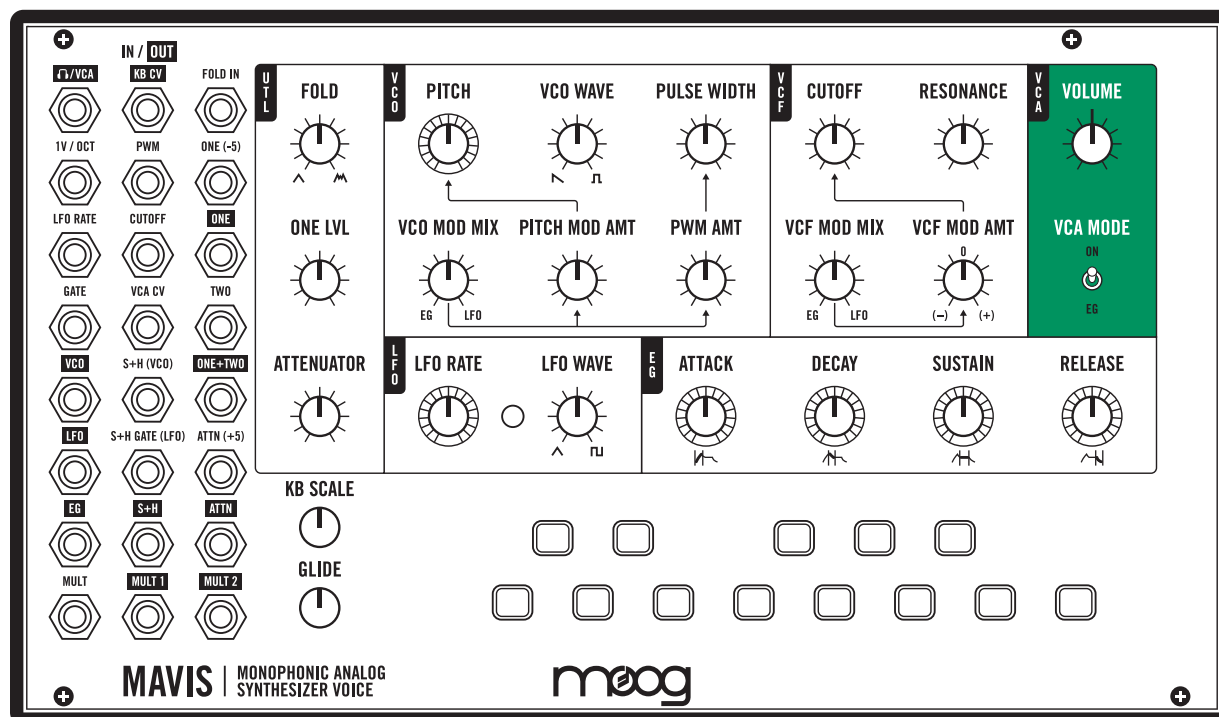

VCA PARAMETERS

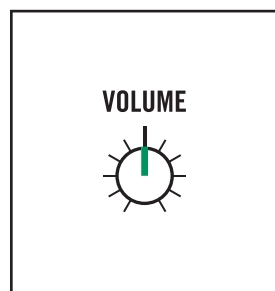

VOLUME

The output level of Mavis is affected by a number of factors—Sustain Level, Cutoff Frequency, etc. The **□/VCA** output jack is used either for headphone monitoring or as an output to a recording interface, mixer, or to connect with other equipment. If you are listening through headphones, use this knob to set a comfortable listening level. Remember not to blast your ears out. With this **VOLUME** knob fully cranked in the clockwise position, the output amplitude will be about 9 Volts peak-to-peak.

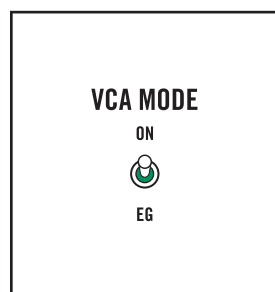

VCA MODE

Normally, the **VCA MODE** switch is off, and the **VCA** level is set by the **EG(+)** level and the **VCA CV** input. Turning the **VCA MODE** switch on causes the **VCA** to produce a constant sound level, as determined by the **VOLUME** knob. Even so, the **VCA MODE** position still allows you to create some nice rhythmic elements by using **LFO** and **EG** modulation to the Cutoff frequency, while manually performing with the **RESONANCE** knob to get some pulsating effects.

The Keyboard

Mavis is equipped with a one-octave, C to C keyboard. The keyboard uses soft-touch buttons, as opposed to traditional keys, but the layout is the same. Mavis may be played directly from this onboard keyboard, or from an external keyboard, a sequencer, or a controller using the **1V/OCT** input jack (R2; C1) and the **GATE** input jack (R4; C1). Additional features include **KB SCALE** and **GLIDE**.

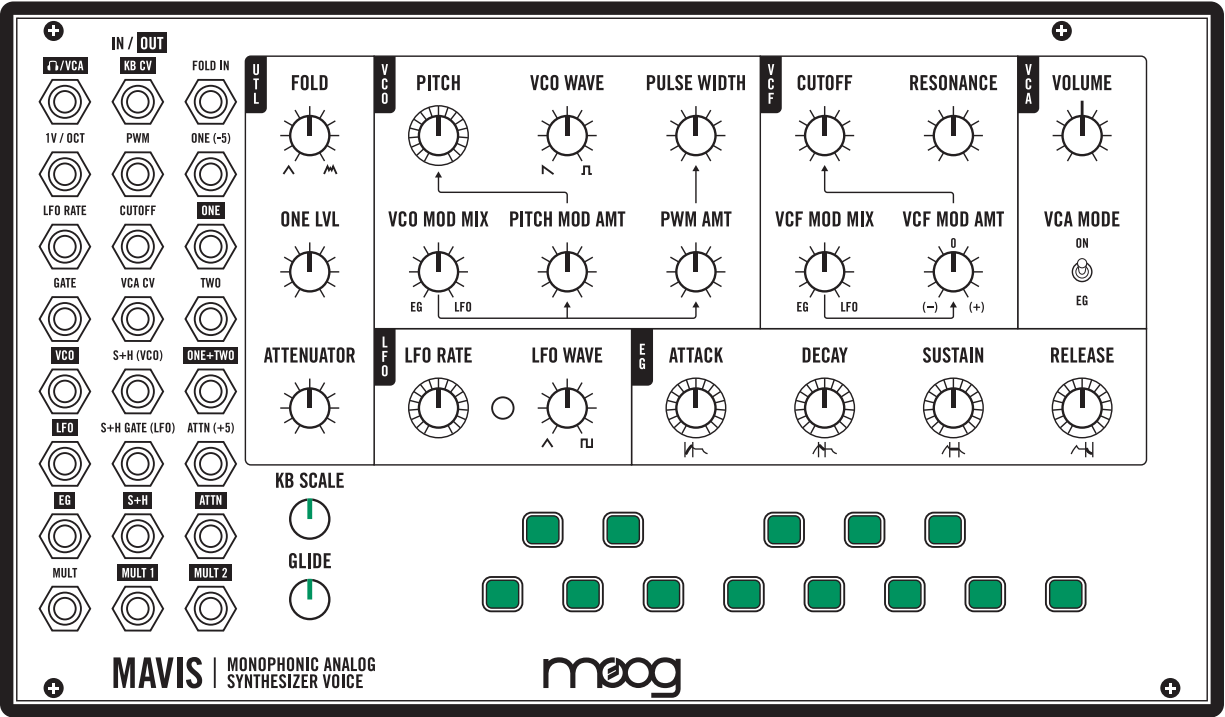

KEYBOARD PARAMETERS

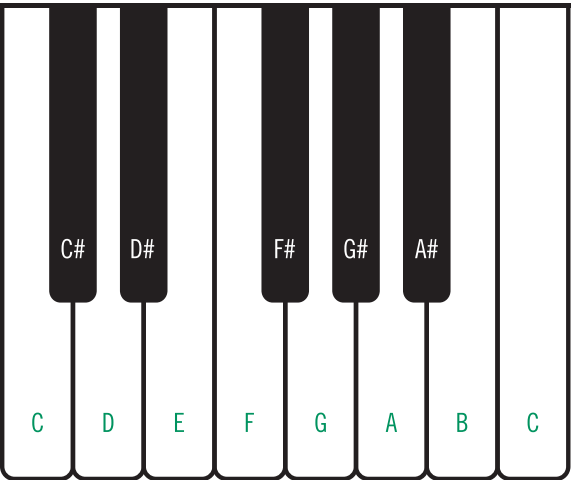

KEYS

This diagram shows how the Mavis “button” keyboard (above) relates to a standard piano keyboard. Although the note names shown are correct for this layout, the actual note being produced will also depend on many factors, including the setting of the **VCO PITCH** knob.

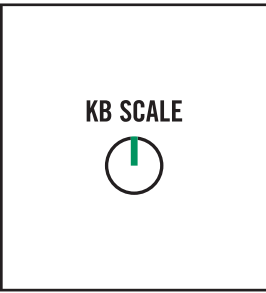

KB SCALE (Keyboard Scaling)

With the **KB SCALE** knob rotated to the full counterclockwise position, the difference between the low C on the keyboard and the high C on the keyboard will be one octave, as you would expect. This change is also equivalent to one volt, or one volt per octave in modular synthesis terminology.

Rotating the **KB SCALE** knob in the clockwise direction can change the note range (and voltage range) between the low C and the high C. This can be useful for expanding the keyboard range, creating effects, etc. With the **KB SCALE** knob in the full clockwise position, the difference between low C and High C will be five octaves, or five volts.

*TIP: The value of the **KB CV** output jack is determined by the note being played, and by the setting of the **KB SCALE** knob.*



GLIDE

Unlike on a keyboard, a violin player can smoothly transition from one note to the next by sliding their finger up or down the neck of the instrument. Adding Glide allows the synthesizer to also smoothly transition from one note to the next.

Rotating the **GLIDE** knob in the clockwise direction will increase the amount of time needed to glide from one pitch to the next. The maximum value is around nine seconds. Rotating the knob in the counterclockwise direction will shorten the time needed. In the full counterclockwise position, no Glide effect is added.

*TIP: The value of the **KB CV** output jack is also affected by the setting of the **GLIDE** knob.*

The Utilities (UTL)

There are a number of very powerful synthesis modules integrated into Mavis. While some of the features and functions reside under the hood and in the patchbay, this Utilities section brings several important controls to the surface.

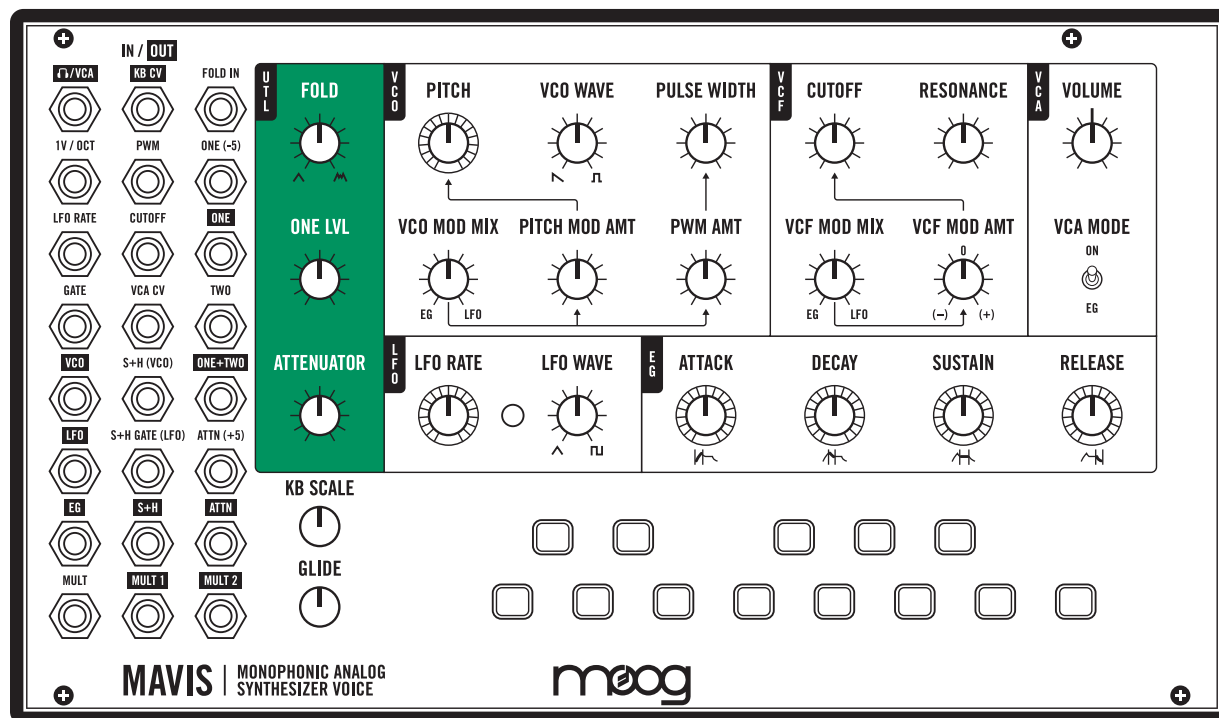

UTILITIES PARAMETERS

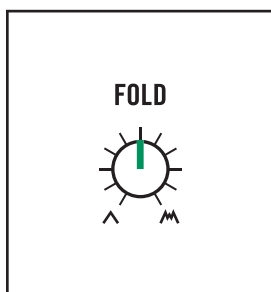

FOLD

The Wave Folder effect is applied to any signal connected to the **FOLD IN** input jack (R1; C3). Rotating the **FOLD** knob in the clockwise direction will increase the effect, generally adding more bite and snarl to the sound. Rotating the **FOLD** knob in the counterclockwise direction minimizes the effect.

***NOTE:** The wave folder is NOT engaged by default and will have no effect unless a signal is patched to the **FOLD IN** input jack. Patching a signal to **FOLD IN** will connect that signal directly through the wave folder to the **VCF** and **VCA**, bypassing the **VCO**. By patching the **VCO** output jack (R5; C1) to the **FOLD IN** input jack, you can engage the wave folder using Mavis's **VCO**.*



ONE LVL (Mixer Channel one Level)

Mavis is home to a two-input/one-output utility mixer. The level of the signal connected to the **ONE (-5)** input jack (R2; C3) is controlled by the **ONE LVL** knob. This knob can then act as a balance between the signal connected to the **ONE (-5)** input jack and the **TWO** input jack (R4; C3). The mixer output is available at the **ONE+TWO** output jack (R5; C3).

***NOTE:** Because the **ONE+TWO** mixer is meant to handle both audio and CV, the response of the **ONE LVL** knob is exponential to aid in audio mixing.*



ATTENUATOR

The Attenuator can reduce the level of any signal connected to the **ATTN (+5)** input jack (R6; C3). The attenuated signal is available at the **ATTN** output jack (R7; C3).

***NOTE:** Because the **ATTENUATOR** is primarily meant for CV, the response of the **ATTENUATOR** knob is linear.*

The Patchbay



The Patchbay

The Patchbay contains 24 3.5 mm patch points—13 inputs and 11 outputs. Inputs are labeled in **STANDARD** text, while outputs are labelled in **REVERSE** text. Throughout this manual, individual patch points are referenced by their label name, and by their Row and Column coordinates, such as (R4; C2) for the **VCA CV** input jack.

Mavis is a semi-modular analog synthesizer. It contains hard-wired signal paths that make it instantly available as a playable instrument, and it contains a patchbay that allows for further expansion. For example, the built-in keyboard is hard-wired to both play the **VCO** and to trigger the **EG**. The output of the **VCO** feeds into the **VCF**, which then feeds into the **VCA**—all with no patching. The patch points allow for new pathways to be created to expand the sound-creation potential of Mavis, and also allow Mavis to interact with other modular, semi-modular, and Eurorack synthesizers, as well as with other electronic music devices that rely on voltage control.

Mavis comes equipped with a set of five patch cables to get you started. Should you need more, packs of 6" and 12" Moog patch cables are available for purchase from your authorized Moog dealer.

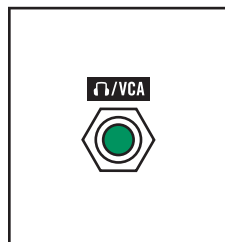
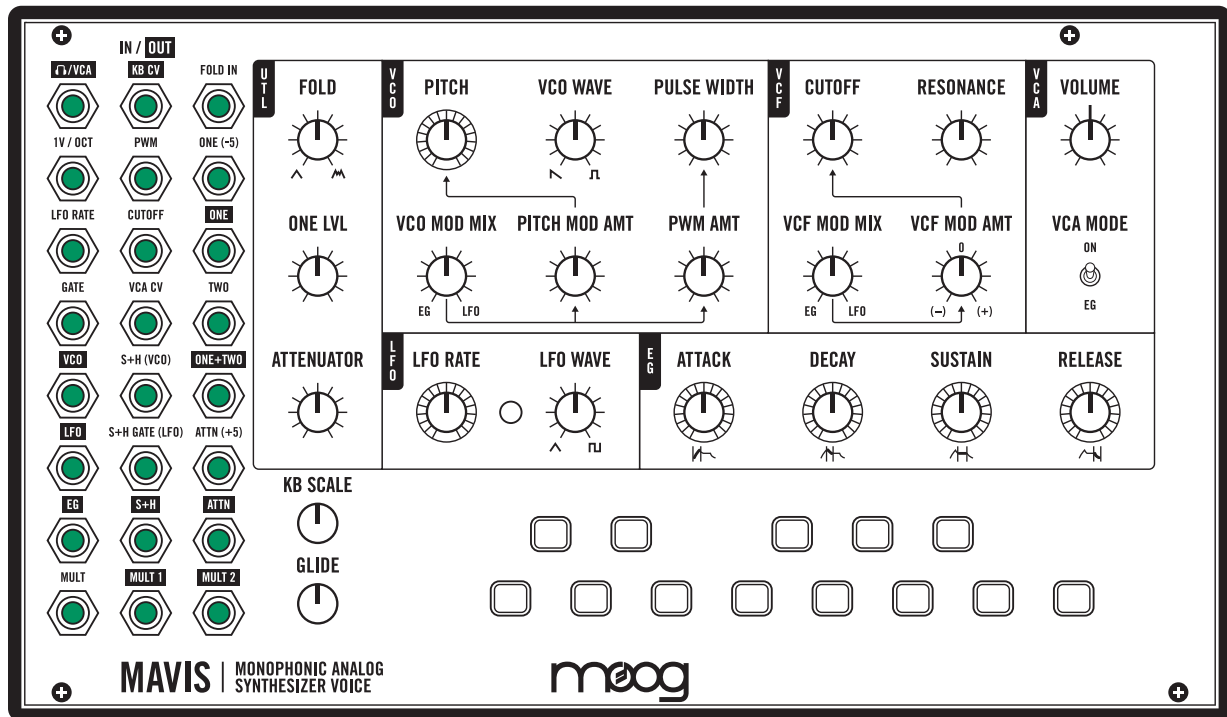

VCA (Headphone Jack/VCA output) R1; C1

The VCA output jack can be used either for headphone monitoring or as an output to a recording interface, mixer, or to connect with other equipment.

CV OUTPUT: -5 V to +5 V typical at full volume

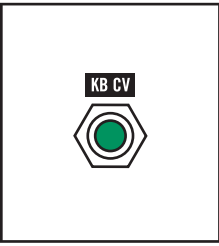

KB CV (Keyboard Control Voltage output) R1; C2

This output carries a voltage equivalent to the voltage of the key being pressed on the Mavis keyboard. This voltage is determined by the key pressed and the value of the **KB SCALE** knob.

CV OUTPUT: 0 V to +1 V with **KB SCALE** fully counterclockwise; 0 V to +5 V with **KB SCALE** fully clockwise

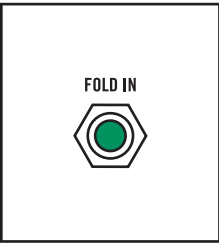

FOLD IN (Wave Folder input) R1; C3

The audio connected to this jack will be processed using the Wave Folder. For more information, refer to "Wave Folding" (page 42).

CV INPUT: -5 V to +5 V max input for no folding with **FOLD IN** control fully counterclockwise



1V/OCT (1 Volt per Octave input) R2; C1

This is a 1V/Octave Exponential frequency modulation input that is summed internally with the **PITCH** control, the Keyboard CV and any **VCO** pitch modulation. With all internal control signals at 0 V, a -5 V to +5 V control voltage at this input will sweep the **VCO** frequency from 8 Hz–8 kHz (10 Octaves).

CV INPUT: -5 V to +5 V

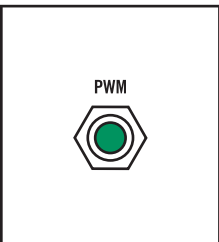

PWM (Pulse Width Modulation input) R2; C2

The control signal received at this input sums with the value of the **PULSE WIDTH** parameter and the **PWM AMT** value, as set by the corresponding knobs. With the **PWM AMT** knob set fully counterclockwise and the **PWM WIDTH** knob set to the midway position, applying a 10 V peak-to-peak signal here will modulate the pulse width between a -5% to -50% duty cycle.

CV INPUT: -5 V to +5 V

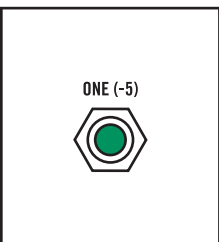

ONE (-5) (Mixer Channel 1 input) R2; C3

This jack is the input to Channel 1 of the internal mixer. The level of this input is controlled by the **ONE LVL** knob in the Utilities section. For more information, refer to "The Mixer" (page 43).

CV INPUT: -10 V to +10 V



ONE (Mixer Channel 1 output), R3; C3

This jack is the output for Channel 1 of the internal mixer. The level of this output is controlled by the **ONE LVL** knob in the Utilities section. For more information, refer to ["The Mixer"](#) (page 43).

CV OUTPUT: -8 V to +8 V

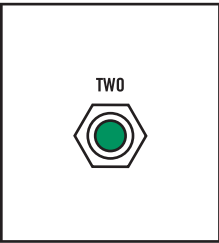

TWO (Mixer Channel 2 input), R4; C3

This jack is the input to Channel 2 of the internal mixer. For more information, refer to ["The Mixer"](#) (page 43).

CV INPUT: -10 V to +10 V

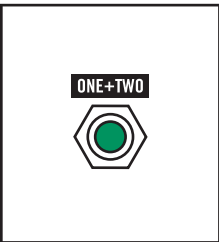

ONE+TWO (Combined Mixer output) R5; C3

This jack carries the output of the utility mixer. The level of Channel 1 is controlled by the **ONE LVL** knob in the Front Panel **UTL** (Utilities). The level of Channel 2 is set to unity gain. For more information, refer to ["The Mixer"](#) (page 43).

CV OUTPUT: -8 V to +8 V



LFO RATE (Low Frequency Oscillator Rate input) R3; C1

This control signal received at this input sums with the **LFO RATE** knob and determines the rate, or speed, of the Low Frequency Oscillator.

CV INPUT: -5 V to +5 V

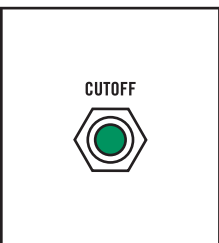

CUTOFF (Voltage Controlled Filter Cutoff Frequency input) R3; C2

This control signal received at this input sums with the Filter **CUTOFF** knob and the **VCF** Modulation signal to determine the value of the **VCF** Cutoff frequency.

CV INPUT: -5 V to +5 V



GATE (External Gate input), R4; C1

The control signal received at this input will trigger the **EG**, and hold the **EG** at the Sustain level until the control signal falls to 0.

CV INPUT: 0 OFF (OFF threshold 1.5 V); +5 V ON (ON threshold 3.5 V)



VCA CV (Voltage Controlled Amplifier input), R4; C2

The control signal received at this input will determine the output level of the **VCA**. Normally, this control signal comes from the **EG**, as determined by the setting of the **VCA MODE** switch.

CV INPUT: 0 V to +8 V



VCO (Voltage Controlled Oscillator output), R5; C1

This output carries the audio signal of the **VCO**, based on all the **VCO** parameter knobs and settings, as well as any patching, such as to the **PWM** input jack (R2; C2) or **1V/OCT** input jack (R2; C1).

CV OUTPUT: -5 V to +5 V (10 vpp), typical

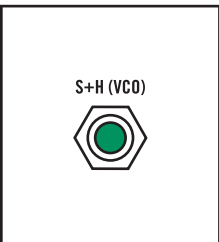

S+H (VCO) (Sample + Hold Voltage input), R5; C2

The signal connected to this input provides a changing voltage to act as a source for the Sample + Hold generator. With no patch cable connected to this input jack, the **VCO** is the default source. For more information, refer to ["Sample + Hold"](#) (page 44).

***NOTE:** The signal patched to this input is inverted before being sent to the S+H circuit. For many common use cases—random voltage generation, audio bit crushing—this is inconsequential, but should be kept in mind when using S+H for other purposes.*

CV INPUT: -5 V to +5 V



S+H GATE (LFO) (Sample + Hold Gate input) R6; C2

The signal connected to this input acts as a Gate for the Sample + Hold generator. With no patch cable connected to this input jack, the **LFO** is the default source. For more information, refer to ["Sample + Hold"](#) (page 44).

CV INPUT: 0 V to +5 V nominal; rising edge triggered; protected TTL Schmidt trigger input

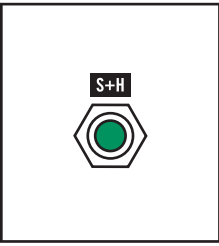

S+H (Sample + Hold output) R7; C2

The output of the Sample + Hold generator is available via this output. For more information, refer to "Sample + Hold" (page 44).

CV OUTPUT: -5 V to +5 V



LFO (Low Frequency Oscillator output) R6; C1

This output carries the LFO signal, based on all the LFO parameter knobs and settings, as well as any patching, such as to the LFO RATE input.

CV OUTPUT: -5 V to +5 V (10 vpp), typical

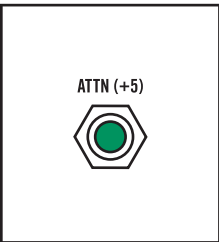

ATTN (+5) (Attenuator input) R6; C3

This jack is the input for the onboard Attenuator. With no patch cable connected to this jack, a control signal of up to +5 Volts, as determined by the **ATTENUATOR** knob in the Front Panel **UTL** section, will be available via the **ATTN** output jack (R7; C3). For more information, refer to "Attenuator" (page 44).

CV INPUT: -10 V to +10 V

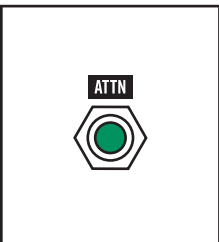

ATTN (Attenuator output) R7; C3

This signal present at this jack is the output of the onboard Attenuator. If no patch cable is connected to the **ATTN (+5)** input jack (R6; C3), then a control signal from 0 Volts up to +5 Volts, as determined by the **ATTENUATOR** knob in the Front Panel **UTL** section, will be available from this jack. For more information, refer to "Attenuator" (page 44).

CV OUTPUT: -10 V to +10 V



EG (Envelope Generator output) R7; C1

This output carries the EG control signal, based on all the EG parameter knobs and settings.

CV OUTPUT: 0 V to +8 V

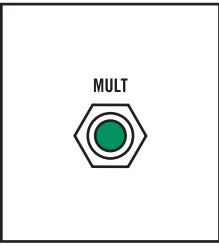

MULT (Mult Jack input) R8; C1

This jack acts as the input to the Mult jacks. This signal connected to this input jack will be available at both of the **MULT** output jacks. This allows the same signal to be sent to two different destinations. For more information, refer to "MULT" (page 43).

CV INPUT: Passive Mult; no range specified

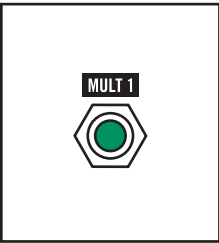

MULT 1 (Mult Jack output A) R8; C2

This signal available via this output jack is identical to the signal connected to the **MULT** input jack (R8; C1). This same signal is also available via the **MULT 2** output jack (R8; C3). For more information, refer to "MULT" (page 43).

CV OUTPUT: Passive Mult; no range specified

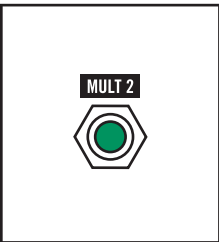

MULT 2 (Mult Jack output B) R8; C3

This signal available via this output jack is identical to the signal connected to the **MULT** input jack (R8; C1). This same signal is also available via the **MULT 1** output jack (R8; C2). For more information, refer to "MULT" (page 43).

CV OUTPUT: Passive Mult; no range specified

Patchbay Module Functions

The patchbay is also home to a number of synthesizer “modules” that cannot be accessed directly from the Front Panel. These modules include the Mixer, Attenuator, Wave Folder, and the S+H generator, as well as a set of convenient Mult jacks. The patch points for these under-the-hood modules are grouped together for ease of use.

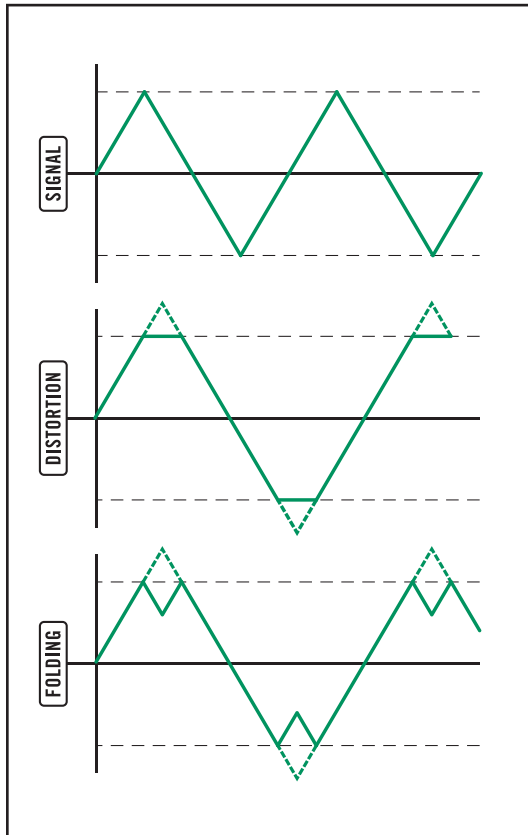

WAVE FOLDING

Normally, when the gain of the signal is high enough to cause clipping, the peak of the wave is simply truncated, flattened, or removed from the wave.

Using the Wave Folder, this truncated peak is inverted and added to the crest of the wave as a series of folds. Mavis employs a circuit design that uses LEDs to carry out the triple-folding process.

The Wave Folder will be applied to any signal connected to the **FOLD IN** input jack (R1; C3); the amount of wave folding is controlled by the **FOLD** knob. Rotating the knob counterclockwise will minimize the effect; rotating the knob in the clockwise direction will add more of the folding effect. Rotating this knob creates a continuous shift in harmonics, so listen as you turn the knob to find the “sweet spot” that completes your sound.

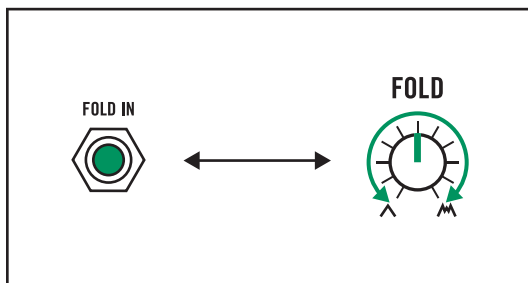

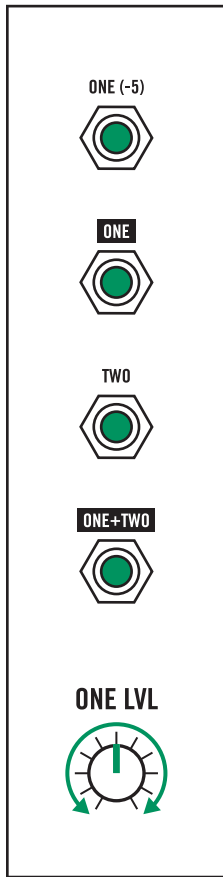

THE MIXER

Mavis is home to a two-channel utility mixer. The level of the signal connected to the **ONE (-5)** input jack (R2; C3) is controlled by the **ONE LVL** knob. This knob can then act as a balance between the signal connected to the **ONE (-5)** input jack and the **TWO** input jack (R4; C3). The mixer output is available at the **ONE+TWO** output jack (R5; C3).

***NOTE:** With nothing connected to the **ONE (-5)** input jack or the **TWO** input jack, the **ONE** output jack can provide a voltage, from -5 Volts to 0 Volts, by adjusting the **ONE LVL** knob.*

*With nothing connected to the **ONE (-5)** input jack and a signal connected to the **TWO** input jack, adjusting the **ONE LVL** knob can add an offset voltage, from -5 Volts to 0 Volts, to the signal connected to the **TWO** input jack as it leaves the **ONE+TWO** output jack.*

In addition to blending two signals together, there are a number of ways this mixer can be used. Here are just a couple of examples.

Splitter: With nothing connected to the **TWO** input jack (R4; C3), the signal connected to the **ONE (-5)** input jack will be available at both the **ONE** output jack (R3; C3) and the **ONE+TWO** output jack (R5; C3).

Amplifier: Start by connecting a signal to the **ONE (-5)** input jack (R2; C3). Next, connect the **ONE** output jack (R3; C3) to the **TWO** input jack (R4; C3). As the value of the **ONE LVL** knob is increased, additional gain can be added to the original signal as it leaves the mixer via the **ONE+TWO** output jack (R5; C3).

***NOTE:** The signal connected to the **TWO** input jack is output from the **ONE+TWO** output jack at unity gain.*

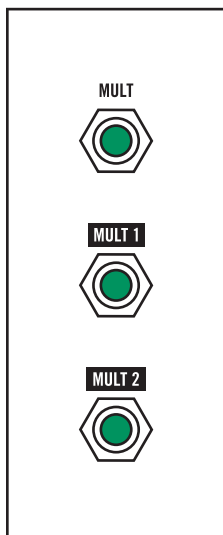

MULT

MULT, Multi, or Multiple jacks are ubiquitous to modular synthesizers. Simply put, they allow the signal connected to the **MULT** input jack (R8; C1) to be sent to two different destinations, using the **MULT 1** output jack (R8; C2) and **MULT 2** jack (R8; C3).

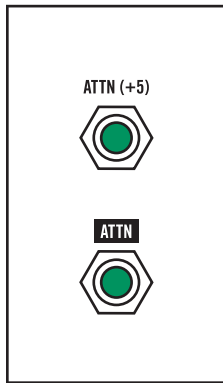

ATTENUATOR

The Attenuator can reduce the level of any signal connected to the **ATTN (+5)** input jack (R6; C3). The attenuated signal is available at the **ATTN** output jack (R7; C3).

NOTE: With nothing connected to the **ATTN (+5)** input jack, the **ATTN** output jack can provide an available offset voltage from 0 Volts to +5 Volts, by adjusting the **ATTENUATOR** knob.

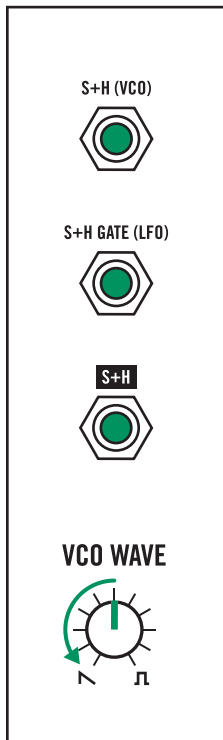

SAMPLE + HOLD

Sample + Hold is a specialized form of modulation that creates a series of stepped voltages that can be applied to change the value of a specific parameter.

A Sample + Hold circuit has two inputs: a signal input—**S+H (VCO)** (R5; C2)—and a gate input—**S+H GATE (LFO)** (R6; C2). When the gate input goes high, the Sample + Hold circuit looks at the voltage at its signal input, grabs the precise voltage value at that instant, and holds it. This held voltage is available at the **S+H** output jack (R7; C2) until the next time the gate input goes high, whereupon a new voltage value will be sampled from the signal input and held.

By default, Mavis uses the **VCO** as the sample source. When using the **VCO** as the Sample + Hold source, keep in mind that the saw wave will provide a much broader range of voltages to sample from than the square wave—as the saw moves linearly between -5 Volts and +5 Volts, while the square jumps between -5 and +5 Volts. Turning the **VCO WAVE** knob to saw will therefore have a much more pronounced effect. An alternative source may be connected to the Sample + Hold signal input via the **S+H (VCO)** input jack (R5; C2).

The **LFO** is the default gate source connected to the Sample + Hold gate input. It will sample a new voltage from the Sample + Hold signal source every time the **LFO** goes high. An alternative source may be connected to the **S+H GATE (LFO)** input jack (R6; C2).

Using Mavis as a Eurorack Module

Mavis can be removed from its case and easily installed into a Eurorack system as a 44 HP module. Mavis draws a maximum of 175 mA from the ± 12 V rail of a Eurorack power supply—it does not use the -12 V rail. Ensure that there is enough headroom on the +12 V rail in your system to power Mavis before installation.

Moog accepts NO responsibility or liability for improperly installed modules.

TO INSTALL MAVIS IN A EURORACK SYSTEM

1. Disconnect external power from the unit.
2. Remove the four black **M3X8 Screws** in each corner of Mavis and keep them somewhere safe. The five screws attaching the **Printed Circuit Board (PCB)** to the **Front Panel** of Mavis should remain in place.
3. Lift the **Front Panel** slowly to remove Mavis from its **Chassis**.
4. Look at the back of Mavis. There is a 10-pin Eurorack power header on the left side of the back of the **PCB** near the top.
5. Connect the 10-pin side of a 10-pin to 16-pin Eurorack ribbon power cable to the power header on Mavis, following the diagram printed on the **PCB** and orienting Pin 1 (-12 V)—the red stripe on the cable—facing upwards. Confirm that this matches the diagram on the **PCB**—*improper installation risks permanently damaging your Mavis!*
6. Connect the other side of the ribbon power cable to your Eurorack system's power supply board—confirming that the red stripe of the cable (representing Pin 1) is aligned with the -12 V orientation indicator on your power distribution board.
7. Mount Mavis into your Eurorack system using the four **M3X8 Screws** you set aside earlier, or using other screws if the rails of your Eurorack case accept a different screw size.
8. Once fully installed, you may power up your Eurorack system and begin to introduce Mavis to the rest of your system.

Calibration



Calibration

Mavis comes to you fully calibrated. However, because it is designed to play with external analog gear, advanced users may want to calibrate Mavis to another instrument. In these cases, access holes are available to conveniently calibrate the **1V/OCT** and **KEYBOARD** without opening the unit.

A calibration tool has been included with Mavis in the event that you need to tune the instrument to the analog or modular gear in your setup. Keep in mind that the internal tuning trimpots are not designed for unlimited use. **ONLY** calibrate when it is absolutely necessary.

WHAT YOU WILL NEED

1. A wide ranging and accurate tuner
2. The included calibration tool
3. A 1V/Octave source (one that is confirmed to be well-calibrated—no more than 1mV error per octave)

KEYBOARD CALIBRATION

1. Make sure Mavis has been powered on for at least 15 minutes, and that it is in a place where the temperature will not change drastically while performing the calibration.
2. Remove all patch cables from the patchbay.
3. Set the panel settings to their [default settings](#) (page 14).
4. Connect the **VCO** output jack on the patchbay to an accurate, high-quality tuner.
5. Set the **PITCH** control precisely to center position.
6. Make sure the **PITCH MOD AMOUNT** control is turned completely counter-clockwise.
7. Press the lowest key on the keyboard (**KB CV** outputs 0 V).
8. Adjust the **PITCH** knob until the tuner registers the nearest “in-tune” note.
9. Press the highest key on the keyboard.
10. The Tuner should now display a note one octave higher than the note heard in Step 8. If necessary, make small adjustments to the trimpot to the right of the **KB SCALE** knob.
11. Repeat Steps 7-10, making small adjustments only if necessary to tighten up your calibration.

1V/OCTAVE CALIBRATION

1. Connect a precision 1V/Octave source outputting 0 V to the **1V/OCT** input jack.
2. Play the lowest key on the Mavis keyboard and adjust the **PITCH** knob until the tuner registers the nearest “in-tune” note.
3. Switch the 0 V source to 2 V.
4. The tuner should display two octaves above Step 2. If necessary, make small adjustments to the trimpot to the right of the **PITCH** knob.
5. Repeat Steps 2-4, making small adjustments only if necessary to tighten up your calibration.

Mavis Signal Flow

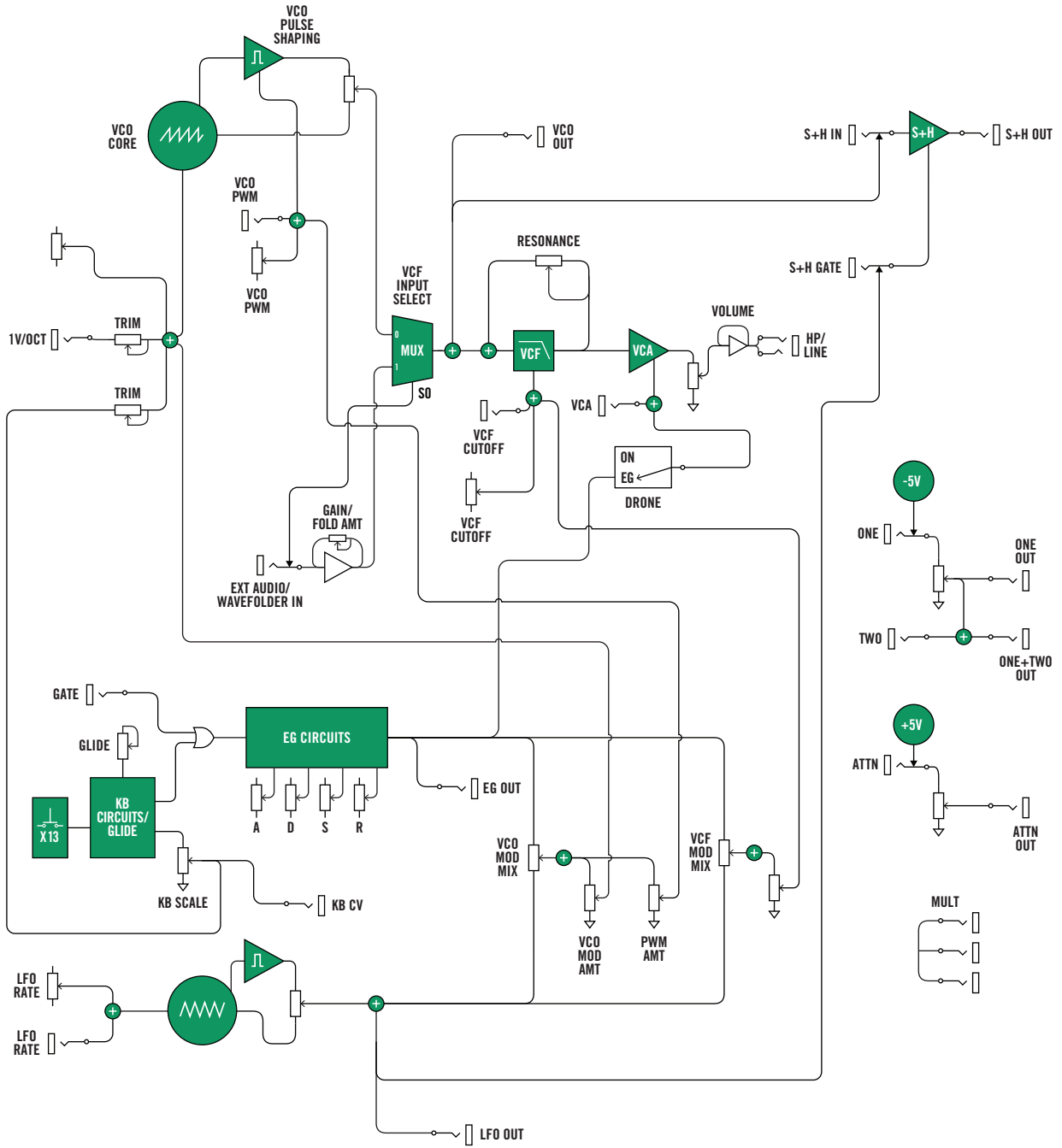

KEY			
	SUMMING		AMPLIFIER
	OR GATE		JACK
	CONNECTION		MODE
	NOT CONNECTED		NORMALISED JACK

Specifications

SOUND SOURCE

VCO (Voltage Controlled Oscillator)

Range: 8 Hz-16 kHz

Controllers:

VCO WAVE knob: Variable mix from Saw to Pulse

PULSE WIDTH Knob: Pulse Width Modulation

PITCH Knob: Sweeps VCO over 8 Octaves

VCO MOD MIX knob: Variable mix from EG to LFO

PITCH MOD AMT knob: Applies modulation to the Pitch

PWM AMT knob: Applies modulation to the Pulse Width

Control Inputs:

1V/OCT: Control Voltage (Pitch)

PWM: Control Voltage (Pulsewidth)

Control Output:

VCO: Oscillator Output

SOUND MODIFIERS

VCF (Voltage Controlled Filter)

Type: 4-pole (24 dB/Octave), Ladder; self-oscillating low-pass filter with resonance

Controllers:

CUTOFF knob: Filter Frequency (30 Hz-20 kHz)

RESONANCE knob: Filter Resonance (Emphasis)

VCF MOD MIX knob: Variable mix from EG to LFO

VCF MOD AMT knob: Applies modulation to the Cutoff frequency

Control Input:

VCF CUTOFF: Filter Cutoff frequency Control

VCA (Voltage Controlled Amplifier)

Controllers:

VCA MODE switch: ON/OFF

VOLUME knob: VCA GAIN (0 V-9 V)

Control Input:

VCA IN: VCA Level Control

Output:

HP/VCA: Headphone Output, VCA Output

MODULATION SOURCES

LFO (Low Frequency Oscillator)

Controllers:

RATE knob: Modulation Frequency (.1 Hz-550 Hz)

LFO WAVE knob: Variable mix from Triangle to Square

Control Input:

LFO RATE: LFO Rate Control Voltage

Control Output:

LFO: LFO Control Voltage

EG (Envelope Generator)

Range: 0 V-5 V

Controllers:

ATTACK knob: Attack Time

DECAY knob: Decay Time

SUSTAIN knob: Sustain Level

RELEASE knob: Release Time

Control Output:

EG: Envelope Control Voltage

UTILITIES

Wave Folder

Controllers:

FOLD knob: Effect Depth

Input:

FOLD: Wave Folder input

Mixer

Controllers:

ONE LVL knob: Volume of Channel One

Inputs:

ONE (-5): Channel One input (normalised to -5 V)

TWO: Channel Two input

Outputs:

ONE: Channel One Output

ONE+TWO: Mixer Output

Attenuator

Controllers:

ATTENUATOR knob: Attenuation Level

Input:

ATTN (+5): Attenuator input (normalised to +5 V)

Output:

ATTN: Attenuator Output

Sample + Hold

Inputs:

S+H IN (VCO): Sample Voltage Source (normalised to VCO)

S+H GATE (LFO): Sample Rate Source (normalised to LFO)

Output:

S+H: Sample + Hold Output

Mult Jacks

Input:

MULT: Mult Jack input

Outputs:

MULT (A): Mult Jack Output (A)

MULT (B): Mult Jack Output (B)

Keyboard

Type: 13 keys (1 Octave); Low-Note Priority; Legato Triggering with Glide

Controllers:

KB SCALE knob: Keyboard Scale width

GLIDE knob: Time of Glide (Portamento) effect

Control Input:

GATE: Gate Voltage input

Control Output:

KB CV OUT: Keyboard Control Voltage Output

POWER

+12 Volts DC; 1.2 Amperes; Center Pin Positive; wall transformer; typical average power consumption -1.8 Watt

Service & Support Information

MOOG'S STANDARD WARRANTY

Moog warrants its products to be free of defects in materials or workmanship and conforms to specifications at the time of shipment. The Warranty Period is one year from the date of purchase. If, in Moog's determination, it has been more than five years since the product shipped from our factory, it will be at Moog's discretion whether to honor the warranty without regard to the date of the purchase. During the Warranty Period, any defective products will be repaired or replaced, at Moog's option, on a return-to-factory basis. This warranty covers defects that Moog determines are no fault of the user.

The Moog Limited Warranty applies to USA purchasers only. Outside the USA the warranty policy and associated service are determined by the laws of the country of purchase and supported by our local authorized distributor.

A listing of our authorized distributors is available at moogmusic.com.

If you purchase outside of your country, you can expect to be charged for warranty as well as non-warranty service by the service center in your country.

RETURNING YOUR PRODUCT TO MOOG MUSIC

You must obtain prior approval in the form of an RMA (Return Material Authorization) number from Moog before returning any product. Email techsupport@moogmusic.com for the RMA number or call us at (828) 251-0090. All products must be packed carefully and shipped with the Moog supplied power adapter. We recommend packing your instrument securely with thick bubble wrap or packing paper. Please avoid packing peanuts, towels, linens, or clothing. These materials do not offer sufficient support and threaten our ESD-safe work environment. Sorry, the warranty will not be honored if the product is not properly packed.

Once you have received the RMA number and carefully packed your Moog Mavis, ship the product to Moog Music Inc. with transportation and insurance charges paid, and be sure to include your return shipping address.

MOOG MUSIC, 160 Broadway St, Asheville, NC, 28801, USA

WHAT WE WILL DO

Once received, we will examine the product for any obvious signs of user abuse or damage as a result of transport. If the product is abused, damaged in transit, or out of warranty, we will contact you with an estimate of the repair cost. Repair work will be performed, and Moog will ship and insure your product to your United States address free of charge.

HOW TO INITIATE YOUR WARRANTY

Please initiate your warranty online at www.moogmusic.com/register. If you do not have web access, please call (828) 251-0090 to register your product.

MOOG'S WARRANTY OUTSIDE THE USA

MOOG'S STANDARD INTERNATIONAL WARRANTY

Moog warrants its products to be free of defects in materials or workmanship and conforming to specifications at the time of shipment.

Outside the USA the warranty policy and associated service is determined by the laws of the country of purchase and supported by our local authorized distributors. A listing of our authorized distributors is available at moogmusic.com. Please feel free to reach out to them or the retailer from whom you purchased your instrument for support.

If you have questions regarding your international warranty, please contact techsupport@moogmusic.com.

HOW TO INITIATE YOUR WARRANTY

Please initiate your warranty online at www.moogmusic.com/register. If you do not have web access, please call (828) 251-0090 to register your product.

HOW TO RETURN YOUR INSTRUMENT FOR SERVICE

Outside the USA, service is determined by the laws of the country of purchase and supported by our local authorized distributors. Please reach out to them or the retailer from whom you purchased your instrument for service support.

If you have questions regarding your international service, please contact techsupport@moogmusic.com.

CARING FOR MAVIS

Clean Mavis with a soft, dry cloth only—do not use solvents or abrasive detergents. Heed the safety warnings at the beginning of the manual. Do not drop the unit.

AN IMPORTANT NOTE ABOUT SAFETY: *There are no user serviceable parts in Mavis. Refer all servicing to qualified personnel only.*

©2022 Moog Music, Inc. All rights reserved.

MOOG, MOOG (stylized with design), and the MOOG logo are trademarks of Moog Music, Inc. Registered in U.S. Patent and Trademark Office and elsewhere. **MAVIS** is a trademark of Moog Music, Inc. **MAVIS** is part of the **WERKSTATT** family of instruments.

Mavis User Manual Version 2

For the most up-to-date user manual and firmware updates, go to www.moogmusic.com/mavis.

Phone: +1 (828) 251-0090

Email: info@moogmusic.com

Website: www.moogmusic.com

moog

Moog Music Inc is an Employee-Owned Company Located in Asheville, NC, USA