









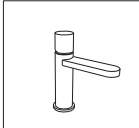

ELKA DESIGN

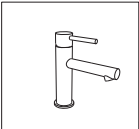
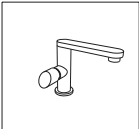
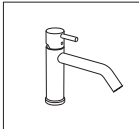
Index

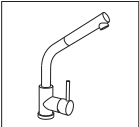
 <p>5</p>	 <p>11</p>	 <p>17</p>	 <p>25</p>
 <p>35</p>	 <p>45</p>	 <p>51</p>	 <p>59</p>
 <p>65</p>	 <p>71</p>	 <p>79</p>	 <p>89</p>
 <p>93</p>	 <p>103</p>	 <p>107</p>	 <p>121</p>

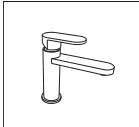
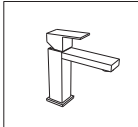
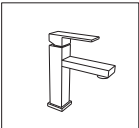
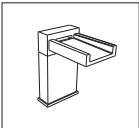
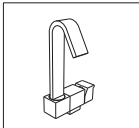
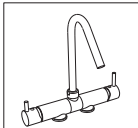
Index

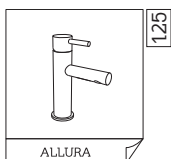

ALLURA

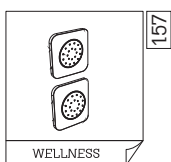

WELLNESS

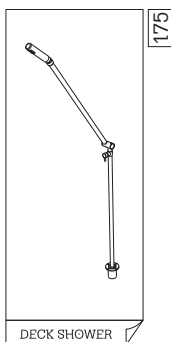

DECK SHOWER

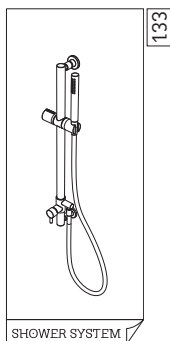

SHOWER SYSTEM

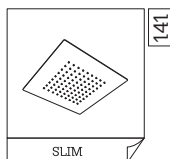

SLIM

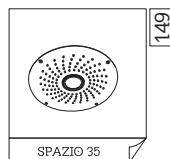

SPAZIO 35

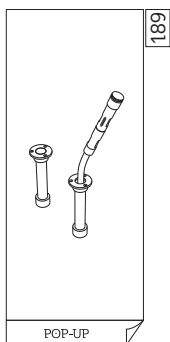

POP-UP

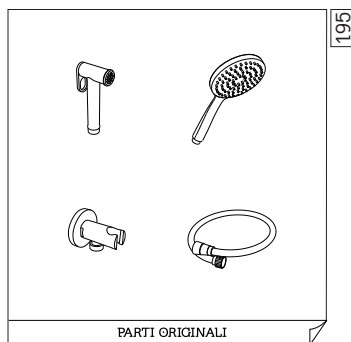

PARTI ORIGINALI

grayton





43300/A

Miscelatore lavabo alto
*Single lever washbasin mixer
with extension*



43300

Miscelatore lavabo
Single lever washbasin mixer



43500

Miscelatore da incasso
Built-in mixer



43500DEV

Deviatore da incasso
Built-in diverter



4335

Miscelatore bidet
Single lever bidet

920910

Asta porta asciugamani
30cm
Towel stand 30cm



920912

Asta porta asciugamani
50cm
Towel stand 50cm



920930

Bicchiere porta spazzolino
Wall container



920960

Appendino singolo
Single coat stand

920940

Portarotolo a scatto
Toilet paper holder

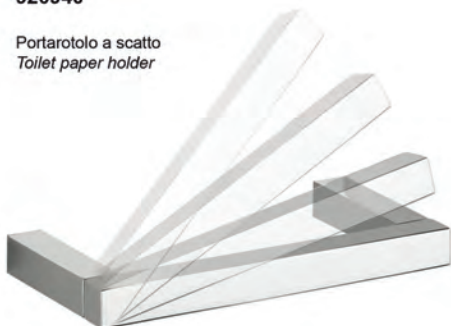

920954

Portascopino da parete
Wall mounted toilet brush holder



olas



78030

Canna da piano fissa
per lavabo sopra piano
con miscelatore satellite
*Fixed spout for out-countertop
basin with remote mixer*



78035

Canna da piano fissa
per lavabo incasso
con miscelatore satellite
*Fixed spout for countertop
basin with remote mixer*



78050

Miscelatore da incasso
Built-in single lever mixer



78050DEV

Deviatore da incasso due vie
Built-in single lever diverter 2 ways



E7207850

Gruppo miscelatore/bocca erogazione su piastra
con fissaggio a scatto
Built-in mixer and spout with fast fitting plate

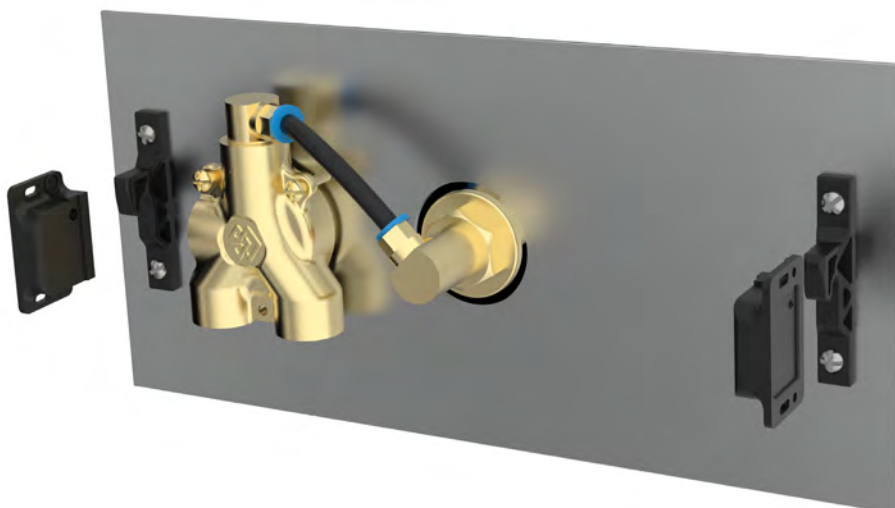



E720050_DEVKIT

Gruppo miscelatore/deviatore con doccia a microfono e uscita acqua su piastra con fissaggio a scatto
Built-in mixer, diverter, hand shower and water outlet with fast fitting plate

ottoecinquanta





435044

Bocca erogazione fissa con miscelatore satellite
"U" shape spout with remote mixer

447050

Batteria 3 fori lavabo da parete
Three holes basin mixer for wall installation

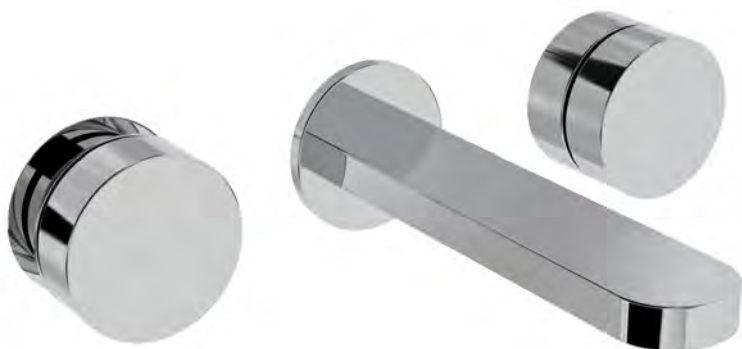

432250

Miscelatore e bocca erogazione da parete
Wall mounted spout with remote mixer

43130/A

Miscelatore lavabo con canna alta
Single lever washbasin mixer with long spout



43130

Miscelatore lavabo
Single lever washbasin mixer





43500

Miscelatore incasso da parete o da piano
Built-in mixer for top or wall



43500DEV

Deviatore incasso da parete o da piano
Built-in diverter for top or wall



4335

Miscelatore bidet
Single lever bidet mixer

4350

Miscelatore incasso da parete o da piano
Built-in single lever mixer for top or wall





44130

Lavabo con vitoni ceramici
Washbasin with ceramic valves



44135

Bidet con vitoni ceramici
Bidet with ceramic valves



1907

Appendino in ottone
Brass coat stand



1904

Portarotolo in ottone
Brass toilet paper holder



1906

Porta asciugamani in ottone
Brass towel stand



1902M

Portascopino in ottone
Brass toilet brush holder

1924M

Dispenser sapone liquido in ottone
Brass liquid soap dispenser



zen



6001_AR

Canna lavello girevole e abbattibile
con miscelatore satellite
*Swivelling and foldable basin spout
with remote single lever mixer*



60011

Miscelatore lavello con canna girevole
*Single lever mixer with
swivelling spout*





6005_KIT

Miscelatore lavello cucina con canna
girevole, comando remoto e kit doccia
shut-off

*Kitchen sink mixer with swivel spout and
remote mixer and shut-off shower kit*



60030

Miscelatore lavabo
*Single lever washbasin
mixer*

60035

Miscelatore bidet
Single lever bidet mixer





60100

Miscelatore lavello con canna girevole
Single lever mixer with swivelling spout

60300
Miscelatore lavabo
*Single lever washbasin
mixer*



60350
Miscelatore bidet
*Single lever bidet
mixer*



6550

Dosatore per sapone liquido in
vetro satinato
*Satin glass soap dispenser
with brass holder*

6505

Portaspazzolino in vetro satinato
*Satin glass
with brass holder*



6510

Portasapone in vetro satinato
*Satin glass soap dish
with brass holder*



6555

Dispenser sapone liquido in ottone
Brass soap dispenser



6540

Portascopino in ottone
Brass toilet brush holder



6515

Appendino singolo in ottone
Brass coat stand



6535

Portarotolo in ottone
Brass toilet paper holder

6530

Porta asciugamani in ottone
Brass towel stand



avirex





70398

Miscelatore cucina con canna girevole
e doccino estraibile
*Single lever mixer with swivelling spout
and ejectable hand shower*



70600

Miscelatore da cucina con canna girevole
e canna piatta, aeratore rettangolare
*Kitchen sink mixer with swivel spout, flat
spout and rectangular aerator*

7030.16

Miscelatore lavabo canna lunga
Single lever mixer with long spout



7030

Miscelatore lavabo
Single lever mixer

7035

Miscelatore bidet
Single lever bidet mixer





7030/A

Miscelatore lavabo
con canna lunga e prolunga
*Single lever mixer with long spout
and extension*

7055

Miscelatore da incasso per piano o parete
Built-in single lever mixer for wall or top





703050/P

Bocca erogazione da parete
con miscelatore e piastra
*Wall mounted spout with
single lever mixer and plate*



7075-2V

Miscelatore incasso doccia con deviatore
ceramico 2 vie
*Built-in shower mixer with 2 ways
ceramic diverter*

6009KIT

Kit duplex con doccia cromo
e flessibile PVC argento
*Duplex kit with hand shower
and PVC flexible hose*



6011KIT

Kit duplex con doccia cromo
e flessibile PVC argento
*Duplex kit with hand shower
and PVC flexible hose*





02105

Portasapone in vetro satinato
Wall satin container

02110

Porta sapone con piatto
in vetro satinato
Wall satin soap dish



02150

Porta sapone liquido
in vetro satinato
Wall satin soap dispenser

02130

Asta porta asciugamano
Towel bar



02116

Appendino singolo
Single coat stand

02140

Portascopino da muro
Wall mounted toilet brush



02135

Portarotolo
Wall mounted toilet paper holder

still





50812

Miscelatore lavello canna girevole
*Single lever sink mixer
with swivelling spout*



50030

Miscelatore lavabo
*Single lever washbasin
mixer*



50035

Miscelatore bidet
Single lever bidet mixer

5083050/P

Bocca erogazione da parete con
miscelatore e piastra
*Wall mounted spout with built-in single
lever mixer and plate*

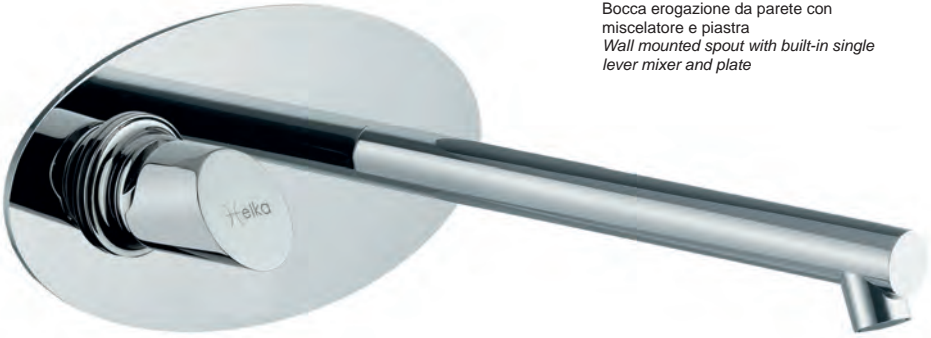

508_6011

Gruppo miscelatore e doccia estraibile
*Built-in single lever mixer for top with
ejectable hand shower*



508144

Kit saliscendi completo di doccia e flessibile ottone,
interasse regolabile
*Wall shower kit with hand shower and flexible hose,
adjustable fixture*



508106

Asta saliscendi con interasse regolabile
Wall shower with adjustable fixture

50850

Miscelatore incasso da piano o da parete
Built-in single lever mixer for top or wall



marin



3015/P

Kit per acqua salata
con rubinetto a vitone e
doccia a pulsante
*Salt water kit with single
tap and pull-out hand shower*



3030

Miscelatore lavabo
Single lever mixer



3035

Miscelatore bidet
Single lever bidet mixer



3020_12900TCU12

Miscelatore lavello con doccia estraibile
Single lever mixer with ejectable hand shower

3020_12900CU12

Miscelatore lavello con doccia estraibile
Single lever mixer with ejectable hand shower





3050.129

Miscelatore incasso con doccia estraibile
e gomito 45°
*Built-in single lever mixer with ejectable
hand shower on 45°degrees elbow*



3050.67

Miscelatore incasso con doccia estraibile
e gomito 90°
*Built-in single lever mixer with ejectable
hand shower on 90°degrees elbow*



Ricarica dall'alto
Top-cap refill system

9001

Dosa sapone da incasso quadro
Square cap built-in soap dispenser



6001

Dosa sapone da incasso tondo
Round cap built-in soap dispenser



3060

Saliscendi con flessibile
in ottone e doccia in ABS
*Sliding rail with brass
flexible hose and ABS hand shower*



3050

Miscelatore incasso
Built-in single lever mixer



3061

Kit doccia con supporto fisso
e doccia in ABS
*Shower kit with ABS hand shower
and brass flexible hose*

3510/0010

Portasapone in plexiglass trasparente
con supporto in ottone
*Transparent plexi soap holder
with brass holder*



3505/0005

Bicchieri in plexiglass trasparente
con supporto in ottone
Transparent plexi glass with brass holder



3540

Portascopino in alluminio verniciato
e supporto in ottone
*Aluminium toilet brush with brass holder
wall installation*



3515

Appendino doppio in ottone
Brass double coat stand



3535

Portarotolo in ottone
Brass toilet paper holder



3525

Porta asciugamani in ottone
Brass towel stand

gane





7730A

Miscelatore lavabo con prolunga
*Single lever washbasin mixer
with extension*



7730

Miscelatore lavabo
Single lever washbasin mixer

7730-170

Miscelatore lavabo canna lunga
Single lever mixer with long spout



7735

Miscelatore bidet
Single lever bidet mixer



7750

Miscelatore incasso da parete
Built-in single lever mixer for wall



7780

Miscelatore esterno doccia con leva laterale
External shower mixer with lateral lever



7790

Miscelatore esterno doccia con leva laterale
External shower mixer with lateral lever



7725

Miscelatore lavabo
Single lever washbasin mixer



7720

Miscelatore bidet
Single lever bidet mixer

bambu





40150

Miscelatore lavello canna girevole
e doccetta estraibile
*Single lever mixer with swivelling spout
and ejectable hand shower*



40003

Miscelatore lavello canna girevole
e doccetta estraibile
*Single lever mixer with swivelling spout
and ejectable hand shower*

4010

Miscelatore lavello canna girevole
Single lever mixer with swivelling spout



401055

Miscelatore lavello canna girevole
e doccetta estraibile
*Single lever mixer with swivelling spout
and ejectable hand shower*

4006

Miscelatore lavello con
canna girevole
*Single lever mixer
with swivelling spout*



4030

Miscelatore lavabo
Single lever washbasin mixer

4040

Miscelatore bidet
Single lever bidet mixer



4030/A

Miscelatore lavabo con prolunga
Single lever mixer with extension



4050

Miscelatore lavabo incasso
Built-in single lever mixer

4080

Miscelatore da parete o da piano
con attacco per tubo doccia
*Single lever mixer for wall
or top with hose connector*



barby





20130

Miscelatore lavello canna girevole
e doccetta estraibile
*Single lever mixer with swivel spout
and ejectable hand shower*



701026

Miscelatore cucina con canna girevole
e doccino estraibile
*Single lever mixer with swivelling spout
and ejectable hand shower*



2015

Miscelatore lavello con canna girevole
Single lever mixer with swivelling spout

2010

Miscelatore lavabo con canna girevole
*Single lever washbasin
mixer with swivelling spout*



2020

Miscelatore lavello con doccia shut-offestraiabile
Single lever mixer with pullout shut-off hand shower





2450

Saliscendi con doccia in ABS e
tubo flessibile in ottone
*Sliding rail with ABS hand shower
and brass flexible hose*



2036

Miscelatore con innesto per
tubo flessibile
*Single lever mixer with
water outlet for flexible hose*



BSUR_2KIT

Rubinetto tondo shut-off con supporto integrato
 $\frac{1}{2}$ M x $\frac{1}{2}$ M
Chromed brass round tap with bracket for shut-off $\frac{1}{2}$ M x $\frac{1}{2}$ M



BSUR_21KIT

Rubinetto Quadro shut-off con supporto integrato
 $\frac{1}{2}$ M x $\frac{1}{2}$ M
Chromed brass square tap with bracket for shut-off $\frac{1}{2}$ M x $\frac{1}{2}$ M

21TKIT

Idroscopino con miscelatore incorporato, tondo
Hidrojet with mixer, round design



21QKIT

Idroscopino con miscelatore incorporato, quadro
Hidrojet with mixer, square design

elle





51745

Miscelatore cucina con canna girevole
Single lever mixer with swivelling spout

51102

Miscelatore lavabo
Single lever basin mixer



51122

Miscelatore lavabo con prolunga
Single lever basin mixer and extension



51155

Miscelatore bidet
Single lever bidet mixer





514350

Miscelatore incasso con piastra
Built-in mixer with plate

514750

Miscelatore e deviatore
con piastra
*Built-in single lever mixer and
diverter with plate*



515030

Bocca erogazione da parete con miscelatore incasso
e piastra
Wall-mounted spout with built-in mixer and plate



512250

Bocca erogazione da parete con miscelatore incasso
Wall mounted spout with built-in mixer

DO.82041

Doccia e microfono ABS cromo
Chrome ABS hand shower



55062

Saliscendi con doccia
microfono e presa acqua
integrata
*Sliding rail with hand shower
and integrated water outlet*



55065_82041

Saliscendi con doccia
microfono e presa acqua
da muro
*Sliding rail with hand shower
and wall water outlet*





5510

Portasapone da parete
Soap dish wall holder

5505

Portaspazzolino
Wall container



5540

Portascopino da parete
Toilet brush wall holder

5550

Portasapone liquido
Soap dispenser



5516

Appendino singolo
Single coat stand



5530

Asta porta asciugamani
Towel stand holder



5520

Anello porta asciugamani
Towel stand ring holder



5525

Asta porta asciugamani
singola
Single towel stand holder



5535

Portarotolo
Toilet paper holder



gin-iro





97030A

Miscelatore lavabo con prolunga
*Single lever washbasin mixer
with extension*



97030

Miscelatore lavabo
Single lever washbasin mixer



97035

Miscelatore bidet
Single lever bidet mixer



97050

Miscelatore incasso da parete
Built-in single lever mixer for wall



97070

Miscelatore incasso da parete e deviatore
Built-in single lever mixer for wall and diverter



97045

Bocca erogazione da parete e miscelatore da
incasso a muro
Wall mounted spout with built-in mixer

farley





90491022

Miscelatore satellite per bocca erogazione girevole
Single lever sink mixer with separated spout



90490

Miscelatore lavabo con prolunga
*Single lever washbasin mixer
with extension*

90492

Miscelatore lavabo
Single lever washbasin mixer



90493

Miscelatore bidet
Single lever bidet mixer



9050.LE0011

Miscelatore incasso da piano o parete
Built-in single lever mixer for top or wall installation



9050.40DEV

Deviatore da incasso
Built-in diverter





904960

Saliscendi con flessibile in PVC e doccia microfono
Sliding rail with PVC flexible hose and hand shower



904961KIT

Duplex doccia microfono con tubo PVC argento
Hand shower duplex with PVC flexible hose



90496

Miscelatore incasso da parete
Built-in single lever mixer for wall

90495M

Miscelatore incasso da parete con deviatore
Built-in single lever mixer with diverter for wall





9050R_LE40

Miscelatore incasso con innesti radiali
Built-in mixer with radial water



9014F07

Appendino singolo
Single coat stand

9014F04

Porta rotolo
Toilet paper holder



9014F01M

Portabicchiere e bicchiere
in ceramica bianca
*Glass holder with
ceramic glass*

9014F03M

Portasapone e piatto
in ceramica bianca
*Soap holder with
ceramic dish*



9014F06

Asta porta asciugamani
Towel stand



9014F24M

Dispenser sapone liquido
in ceramica bianca
*White ceramic liquid soap
dispenser*

9014F02M

Portascopino in ceramica bianca
White ceramic toilet brush holder



inn





935001

Bocca erogazione da parete tonda
Round waterfall spout

935002

Bocca erogazione da parete rettangolare
Rectangular waterfall spout





934413

Lama d'acqua da incasso per parete
orizzontale o verticale
*Built-in water blade outlet
for vertical or horizontal installation*



934408

Bocca erogazione da piano chiusa
Waterfall spout for basin

934406

Bocca erogazione da parete chiusa
Wall mounted waterfall



tip-up





3320_AR_200

Miscelatore abbattibile con canna
girevole corta
*Single lever mixer with lowering and
swivelling short spout*

3320_AR_248

Miscelatore abbattibile con canna
girevole lunga
*Single lever mixer with lowering and
swivelling long spout*

7020_AR

Miscelatore remoto con canna
telescopica e girevole e doccia
estraibile

*Single lever mixer with retractable
and swivelling spout and ejectable
hand shower*



7020_AR_C

Disponibile con doccia corta
Short hand shower available





902020_AR

Miscelatore con canna
telescopica e girevole
*Single lever mixer with
retractable and swiveling spout*





9020_12511AR

Miscelatore remoto con canna
telescopica e girevole e doccia
shut-off estraibile

*Single lever mixer with retractable
and swivelling spout and ejectable
hand shower*





904021_CW

Rubinetto monoacqua con
canna abbattibile
*Only cold water tap with
lowering spout*



9040

Miscelatore abbattibile
con canna girevole
*Single lever mixer with lowering
and swivelling spout*

9040.CW

Rubinetto monoacqua
abbattibile con canna girevole
*Only cold water tap with
lowering and swivelling spout*



901040

Miscelatore cucina con canna girevole
*Single lever sink mixer with
swivelling spout*



901030_CF

Miscelatore lavabo con canna fissa
Single lever washbasin mixer



3040.4V

Gruppo miscelatore e acqua trattata
(depurata o gasata) con canna
girevole e abbattibile
*Single lever mixer with 2 ways outlets
for purified water, lowering and
swivelling spout*



Acqua trattata tipo1
Purified water



Acqua fredda per miscelazione
Cold water for mixer



Acqua trattata tipo 2
Sparkling water



Acqua calda per miscelazione
Hot water for mixer

THE SPOUT



01

02



PTA



C

THE BODY



3040

THE HANDLE



CL



VE



SA

es: 3040/ 02 / SA



3040/01

Miscelatore abbattibile
con canna girevole alta
*Single lever mixer with lowering
and swivelling long spout*



3040/02

Miscelatore abbattibile
con canna girevole bassa
*Single lever mixer with lowering
and swivelling short spout*



3115_CN1

Rubinetto monoacqua
con canna girevole e
abbattibile
*Single water tap with
foldable and swivelling spout*



3115_SC

Canna girevole e
abbattibile
*Foldable and
swivelling spout*



3110_CN1

Rubinetto miscelatore
con canna girevole e
abbattibile
*Hot/cold water tap with
foldable and swivelling spout*





2100/A

Rubinetto miscelatore
con canna abbattibile
*Hot/cold water tap with
foldable spout*

2105/A

Rubinetto miscelatore
con attacco 3/8" M centrale
*Hot/cold water tap with
3/8" Male hose connection*



2120

Rubinetto monoacqua
con canna destra abbattibile
*Single water tap with
foldable DX spout*

2125

Rubinetto monoacqua
con canna sinistra abbattibile
*Single water tap with
foldable SX spout*



H2Pure



3737/SW

Miscelatore da cucina con acque separate e doccetta side spray shut-off
Kitchen sink mixer with separated water flow, with shut off side spray



4045SW

Miscelatore lavello con canna girevole e circuito acqua salata separato
Single lever sink mixer with swiveling spout and salt water circuit

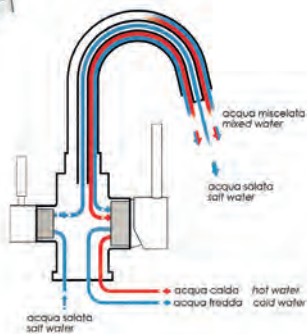



316563

Miscelatore da piano con bocca girevole ed estraibile, con comando remoto per trattamento acque e bocca girevole di erogazione acqua depurata in AISI 316

Deck mounted mixer set with swivelling and extractable spout, with remote control for water treatment and dedicated swivelling spout for filtered water in AISI 316 stainless steel



316385

Miscelatore tre vie per acqua miscelata e acqua proveniente da filtrazione in acciaio AISI 316

Mixer and on-off tap in AISI 316 stainless steel with swivelling spout

allura





7020ARAL

Miscelatore abbattibile lavello
con doccia estraibile e canna girevole
realizzato completamente in alluminio
*Single lever under window mixer
with handshower and swivel spout
totally made in aluminium*

g 1.260



7035AL

Miscelatore bidet
Single lever bidet mixer

g 157



7050AL

Miscelatore incasso
Built-in mixer

g 110



7030.16AL

Miscelatore lavabo con canna lunga
*Single lever washbasin mixer
with long spout*

g 170



7030AL

Miscelatore lavabo
*Single lever washbasin
mixer*

g 155



4030AL/A

Miscelatore cartuccia diametro 35mm
canna alta
*Single lever washbasin mixer with
35mm diameter cartridge and extension*

4030AL

Miscelatore cartuccia diametro 35mm
*Single lever washbasin mixer with
35mm diameter cartridge*



3510AL/0010

Portasapone e supporto a muro
realizzato completamente in alluminio
*Wall-mounted soap holder
totally made in aluminium*



g 130

3505AL/0005

Porta spazzolino e supporto a muro
realizzato completamente in alluminio
*Wall-mounted glass holder and glass
totally made in aluminium*



g 123

3540AL

Portascopino e supporto a muro
realizzato completamente in alluminio
*Wall-mounted toilet brush holder
totally made in aluminium*

g 210



DP_3052AL

Presca acqua e supporto doccia manuale
con attacco per tubo flessibile
completamente in alluminio
*Water inlet with handshower holder
and water connection for flexible hose
totally made in aluminium*



g 140



3535AL

Portarotolo
completamente in alluminio
*Toilet paper holder
totally made in aluminium*

g 95

3525AL

Asta porta asciugamani
totalmente in alluminio
*Towel stand
totally made in aluminium*

g 160



3514AL

Appendino singolo
totalmente in alluminio
*Single coat stand
totally made in aluminium*



g 10

shower system





Colonna da pavimento a soffitto con passaggi acqua nella base.
Possibilità di collegare un soffione utilizzando un deviatore

*Floor-to-ceiling shower pole with water connectors in the bottom
Available with diverter to combine with a shower head*

7080

Colonna da terra con cartuccia miscelatore
Shower pole with cartridge mixer

7080_D

Colonna da terra con cartuccia miscelatore e deviatore
Shower pole with cartridge mixer and diverter

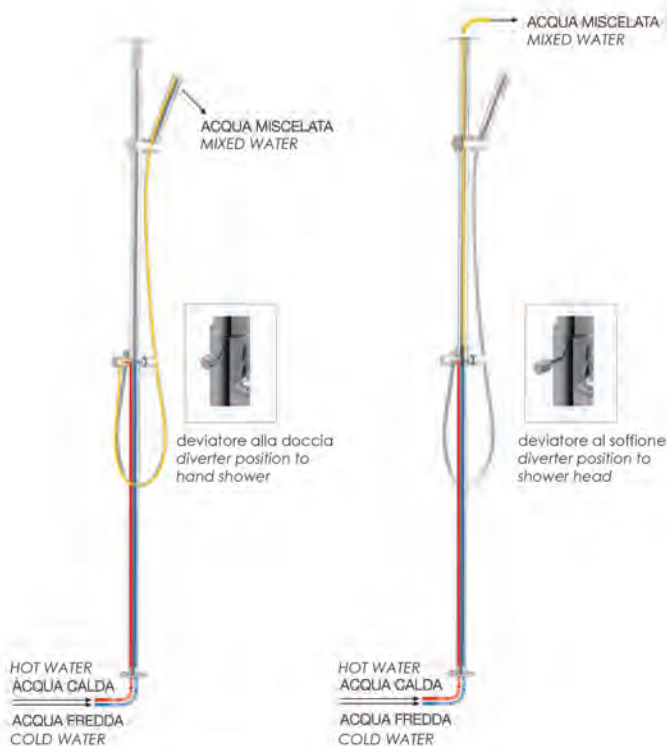



Colonna da pavimento con passaggi acqua nella base.
Possibilità di collegare una doccia a microfono utilizzando un deviatore

*Floor shower pole with water connectors in the bottom
Available with diverter to combine with an hand shower*

7085

Colonna da terra con
cartuccia miscelatore
e microsoffione
*Shower pole with cartridge mixer
and compact head shower*

7085_D

Colonna da terra con
cartuccia miscelatore,
microsoffione e deviatore
*Shower pole with cartridge mixer,
compact head shower and diverter*

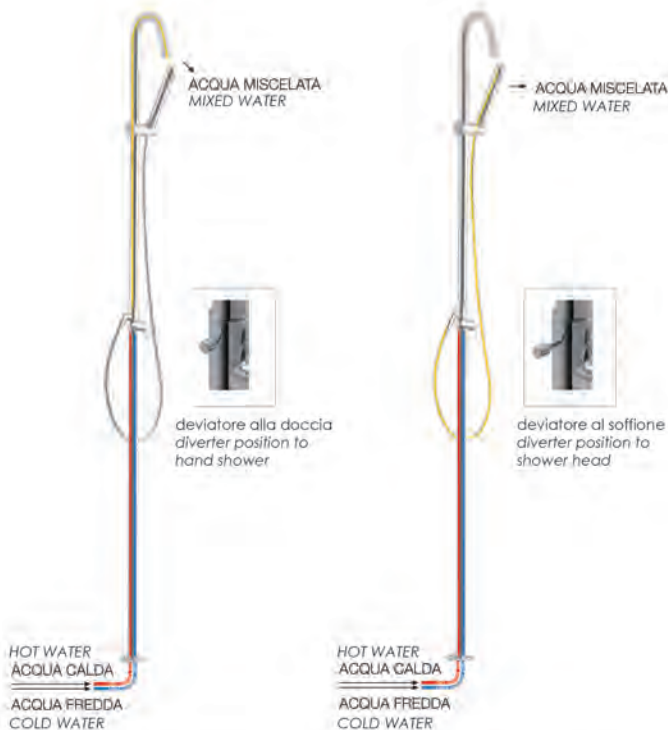

Installazione saliscendi tradizionale (4 fori)

Standard installation



Installazione asta 7090Q (2 fori)

7090Q installation

7090Q

Asta doccia con miscelatore integrato
e sistema di fissaggio a muro
con innesti rapidi
*Shower rail with integrated
mixer cartridge and fast connectors
for wall installation*





7080_C

Modello 7080 con pali in carbonio
7080 model with carbon fiber poles

7080_D_C

Modello 7080_D con pali in carbonio
e deviatore
*7080_D model with carbon fiber
poles and diverter*

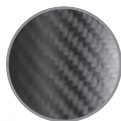

7085_C

Modello 7085 con pali in carbonio
7085 model with carbon fiber poles

7085_D_C

Modello 7085_D con pali in carbonio
e deviatore
*7085_D model with carbon fiber
poles and diverter*

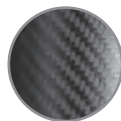



7090Q_C_DG

Modello 7090Q con palo in carbonio opaco
e finitura deep gray
*7090Q model with matte carbon fiber pole
and deep gray finish*

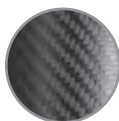

7090Q_CL

Modello 7090Q con palo in carbonio lucido
e finitura cromo
*7090Q model with polished carbon fiber
pole and chrome finish*

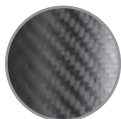

slim



DO.604046

Soffione incasso quadro
Built-in square shower head



□ 380

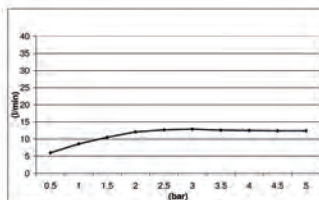

DO.604024

Soffione incasso quadro
Built-in square shower head

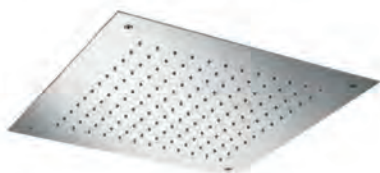

□ 500

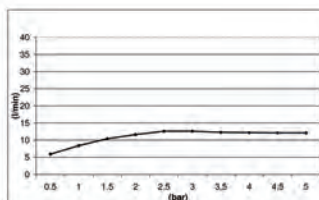

DO.604048

Soffione incasso tondo
Built-in round shower head



ø 380

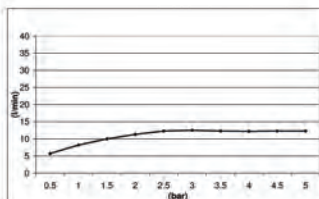
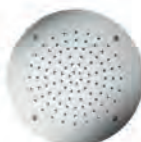

DO.604047

Soffione incasso tondo
Built-in round shower head



ø 500

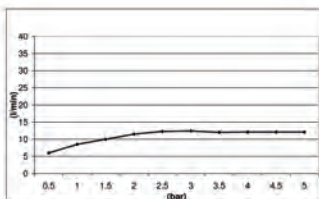



D_44096OT

Soffione incasso quadro raccordato
Built-in shaped square shower head



□ 420

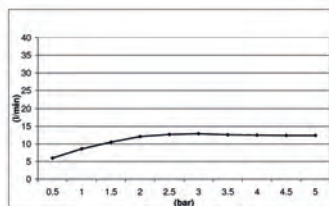

D_44099 (ABS/plastic) D_44095 (ottone/brass)

Soffione quadro raccordato
Shaped square shower head

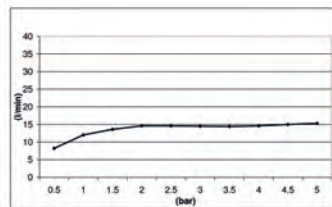
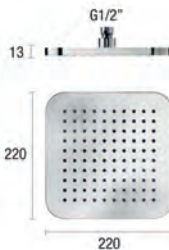



D_44258

Soffione da incasso con getto
rain e getto ice
*Dual function rain/ice built-it
head shower*





D_44168

Soffione minimale ABS
cromo quadro
*Compact chrome ABS
shower head square*

□ 120

Braccio non incluso
Arm non included



D_44169

Soffione minimale ABS
cromo tondo doppio getto
*Compact chrome ABS
shower head round
with double jet*

Ø 130

Braccio non incluso
Arm non included

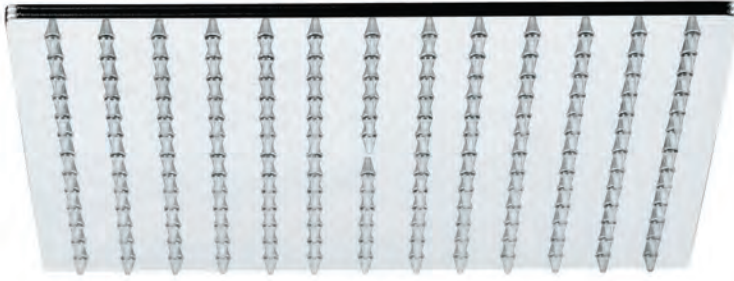

D_958_100

Soffione quadro 100x100mm
in acciaio
*Square head shower
100x100mm stainless steel*

D_958_200

Soffione quadro 200x200mm
in acciaio
*Square head shower
200x200mm stainless steel*

D_958_300

Soffione quadro 300x300mm
in acciaio
*Square head shower
300x300mm stainless steel*

D_958_400

Soffione quadro 400x400mm
in acciaio
*Square head shower
400x400mm stainless steel*

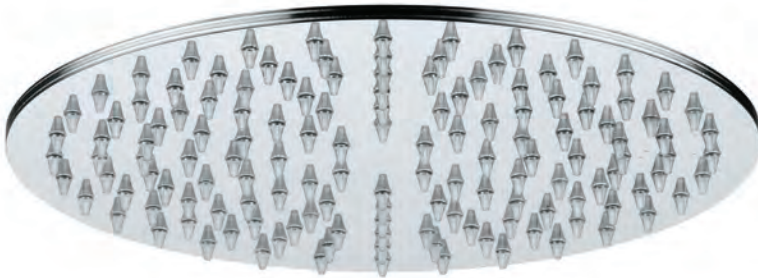

D_962_100

Soffione tondo 100mm
in acciaio
*Round head shower 100mm
stainless steel*

D_962_200

Soffione tondo 200mm
in acciaio
*Round head shower 200mm
stainless steel*

D_962_300

Soffione tondo 300mm
in acciaio
*Round head shower 300mm
stainless steel*

D_962_400

Soffione tondo 400mm
in acciaio
*Round head shower 400mm
stainless steel*



BR_21061

Braccio doccia da parete quadro
Square wall arm



BR_21066

Braccio doccia da parete quadro
con ghiera arrotondata
*Square wall arm
with rounded trim*



BR_21060

Braccio doccia da parete tondo
Round wall arm



BR_21048

Braccio doccia da soffitto quadro
Square ceiling arm



BR_21017

Braccio doccia da soffitto tondo
Round ceiling arm

spazio35



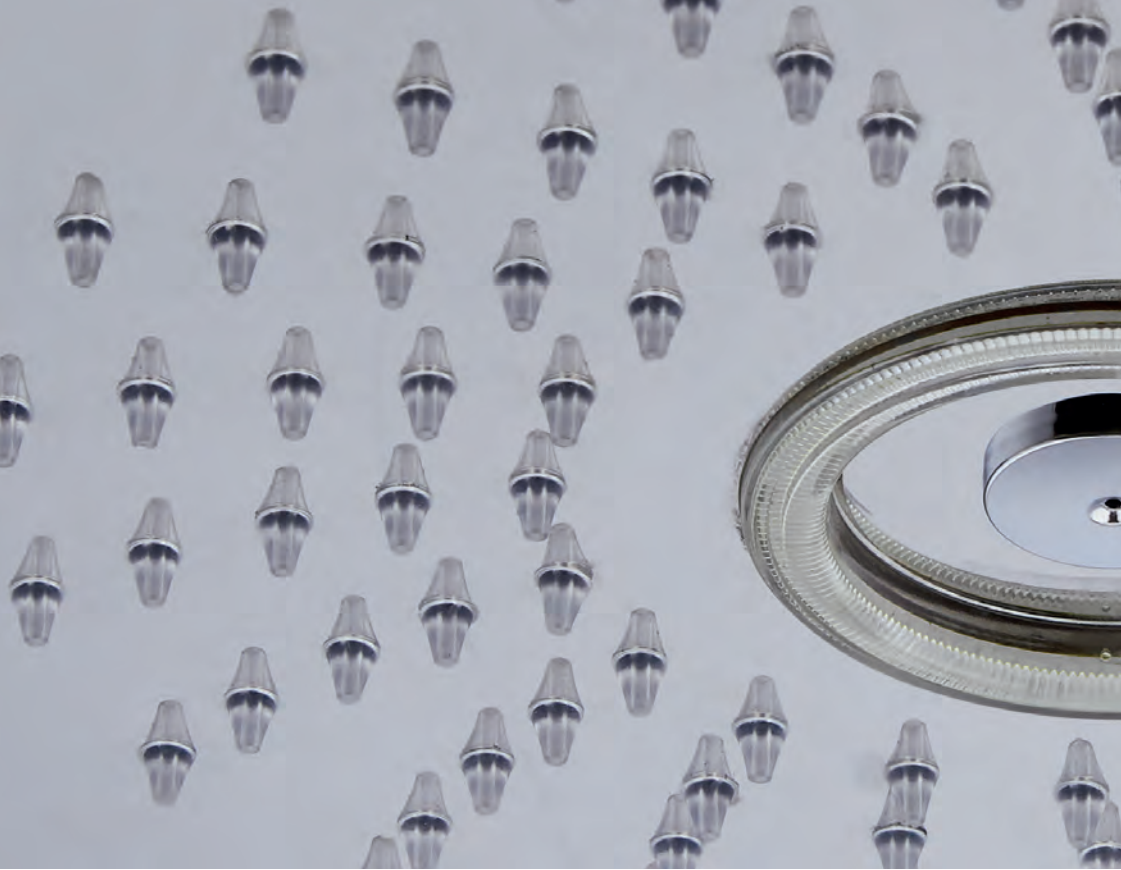



The thinnest built-in shower around.

25mm installation depth required for the standard 3/8" Female connection hose.

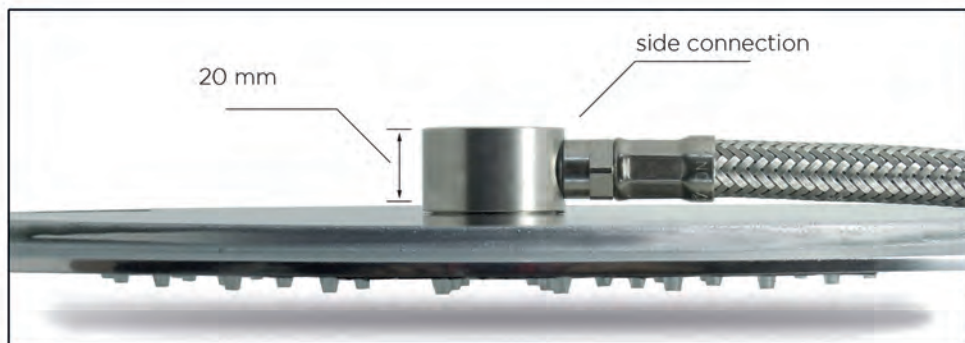

round shape 250mm

D_641501

Soffione tondo da incasso
Built in round head shower

D_641501_12V D_641501_24V

Soffione tondo da incasso con led bianchi
Built in round head shower with ice white leds

D_641501_05

Soffione tondo da incasso
finitura acciaio spazzolato
*Built in round head shower
scotch brite finish stainless steel*

D_641501_12V_05 D_641501_24V_05

Soffione tondo da incasso con led bianchi
finitura acciaio spazzolato
*Built in round head shower with ice white leds
scotch brite finish stainless steel*

square shape 210x210mm

D_64200

Soffione quadro da incasso
Built in square head shower

D_64200_12V D_64200_24V

Soffione quadro da incasso
con led bianchi
*Built in square head shower
with ice white leds*

D_64200_12V_RGB

Soffione quadro da incasso
con led RGB
*Built in square head shower
with RGB leds*

D_64200_05

Soffione quadro da incasso
finitura acciaio spazzolato
*Built in square head shower
scotch brite finish stainless steel*

D_64200_12V_05 D_64200_24V_05

Soffione quadro da incasso
con led bianchi
finitura acciaio spazzolato
*Built in square head shower
with ice white leds
scotch brite finish stainless steel*

D_64200_12V_RGB_05

Soffione quadro da incasso
con led RGB
finitura acciaio spazzolato
*Built in square head shower
with RGB leds
scotch brite finish stainless steel*

rectangular shape 320x200mm

D_642032

Soffione rettangolare da incasso
Built in rectangular head shower

D_642032_12V D_642032_24V

Soffione rettangolare da incasso
con led bianchi
*Built in rectangular head shower
with ice white leds*

D_642032_12V_RGB D_642032_24V_RGB

Soffione rettangolare da incasso
con led RGB
*Built in rectangular head shower
with RGB leds*

Accessori:

Available features:



LED DIMMER CPU



RGB CPU



D_39105S

Soffione a soffitto ispezionabile tondo \varnothing 340 fissaggio con molle
Inspectable round showerhead \varnothing 340 with ceiling-mount spring assembly

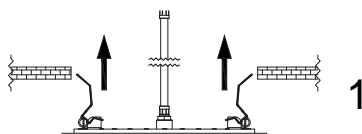

1

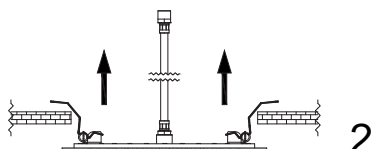

2

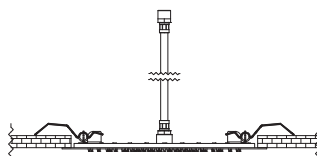

3



D_39114S

Soffione a soffitto ispezionabile quadro 340 x 340 fissaggio con molle
Inspectable square showerhead 340 x 340 with ceiling-mount spring assembly



D_64200S

Soffione incasso in acciaio inox 210mm
fissaggio a molla
*Stainless steel built-in shower head
with springs, 210mm*

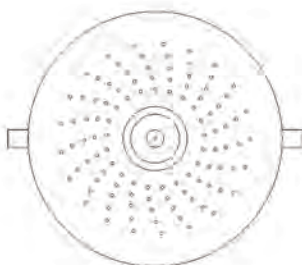

D_641501S

Soffione tondo 250mm in acciaio inox con molle
*Stainless steel round built-in shower head
with springs, 250mm*

D_641501S_12V

Soffione tondo 250mm in acciaio inox con molle
e led COB 12V
*Stainless steel round built-in shower head
with springs, 250mm, 12V COB led crown*

D_641501S_12VR_BJ

Soffione tondo 250mm in acciaio inox con molle,
led COB 12V e nebulizzatore
*Stainless steel round built-in shower head
with springs, 250mm, 12V COB led crown, spray jet.*

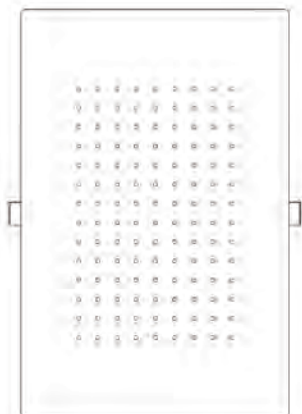

D_642032S

Soffione incasso in acciaio inox 210x320mm
fissaggio a molla
*Stainless steel built-in shower head
with springs, 210x320mm*

wellness





D_44241

Colonna quadra con soffione,
cascata emozionale, doccia a
microfono e deviatore
*Squared shower column with
shower head, emotional waterfall,
hand shower and diverter*









EMERALD pack: built-in XL shower
with chromo therapy
double water blade
six adjustable bodyjets
water outlet with hand shower



A modern shower stall with a wooden wall. A large circular rain showerhead is mounted on the ceiling, and three adjustable bodyjet nozzles are mounted on the wall. A hand shower is also visible on the wall. The scene is dimly lit, with a spotlight effect on the wall.

GARNET pack: built-in XL shower
with music therapy
three adjustable bodyjets
water outlet with hand shower



JADE pack: wall shower with water blade
four adjustable bodyjets
water outlet with hand shower



D_44217 (380)

D_44218 (300)

Soffione ad incasso
380x380mm o 300x300mm
con spray jets
*Built-in shower head,
380x380mm or 300x300mm
with spray jets*



D_44219

Soffione ad incasso
diametro 380mm
con spray jets
*Built-in shower head,
380mm diameter,
with spray jets*



D_44216

Soffione ad incasso
380x380mm
con lama per cascata cervicale
*Built-in shower head,
380x380mm
with blade outlet for
waterfall*



D_4065_RGB

Soffione tondo da incasso ø380mm con ugelli RGB
Built-in ø380mm shower head with variable light cartridge



D_44139_RGB

Soffione quadro da incasso 500x500 mm con ugelli RGB, cascata cervicale e spray jet
Built-in 500x500mm shower head with variable light cartridge, waterfall and spray jet



D_44111_RGB

Soffione rettangolare da incasso 700x380mm con ugelli RGB e cascate cervicali
Built-in 700x380mm shower head with variable light cartridge and waterfalls

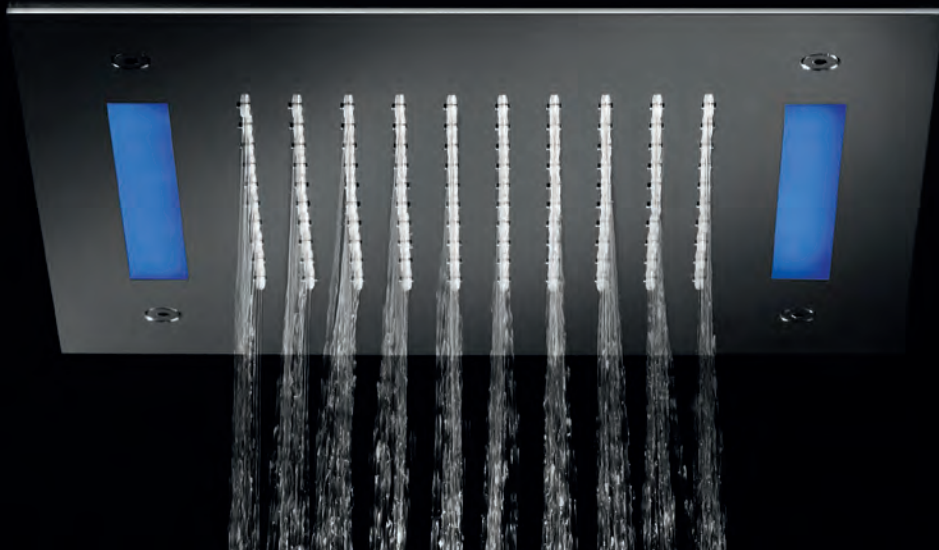

D_44172_RGB

Soffione quadro da incasso 300x300 mm con finestre RGB
Built-in 300x300mm shower head with variable light windows



D_44197_RGB

Soffione quadro da incasso 500x500 mm con finestre RGB
Built-in 500x500mm shower head with variable light windows



D_44211

Soffione quadro da incasso 630x480mm con finestre RGB, spray jets e diffusori sonori Bluetooth
Built-in 630x480mm shower head with variable light windows, spray jets and Bluetooth speakers

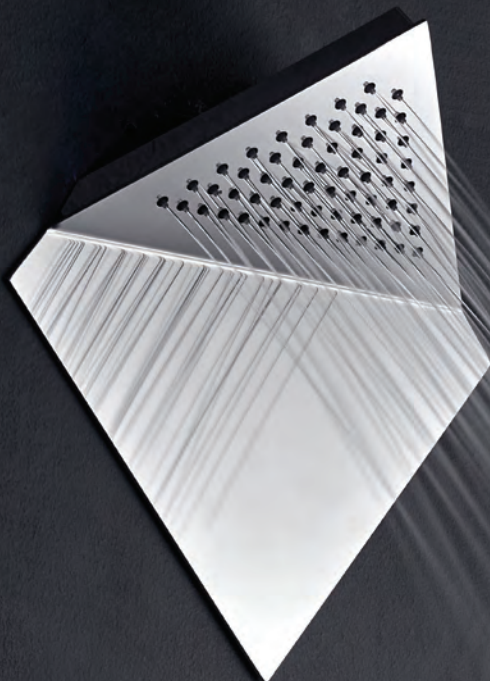

D_35035

Soffione a pioggia
*Arriswise wall-mount rain
showerhead*



D_35050

Soffione angolare tondo
Round mounted showerhead



D_62015

Soffione flex regolabile
*Flex adjustable wall mounted
cylindric showerhead ø 100*

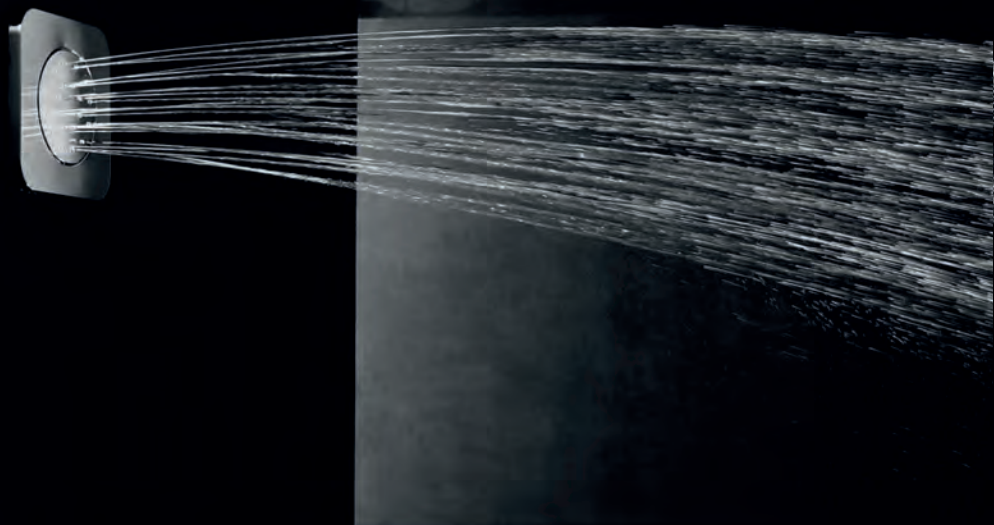

BODYJET

BJ085 Bodyjet da incasso orientabile ABS cromo quadro
Built-in adjustable ABS chrome square frame bodyjet



BJ091 Bodyjet da incasso orientabile ABS cromo raccordato
Built-in adjustable ABS chrome blended frame bodyjet



BJ084 Bodyjet da incasso orientabile ABS cromo tondo
Built-in adjustable ABS chrome round frame bodyjet



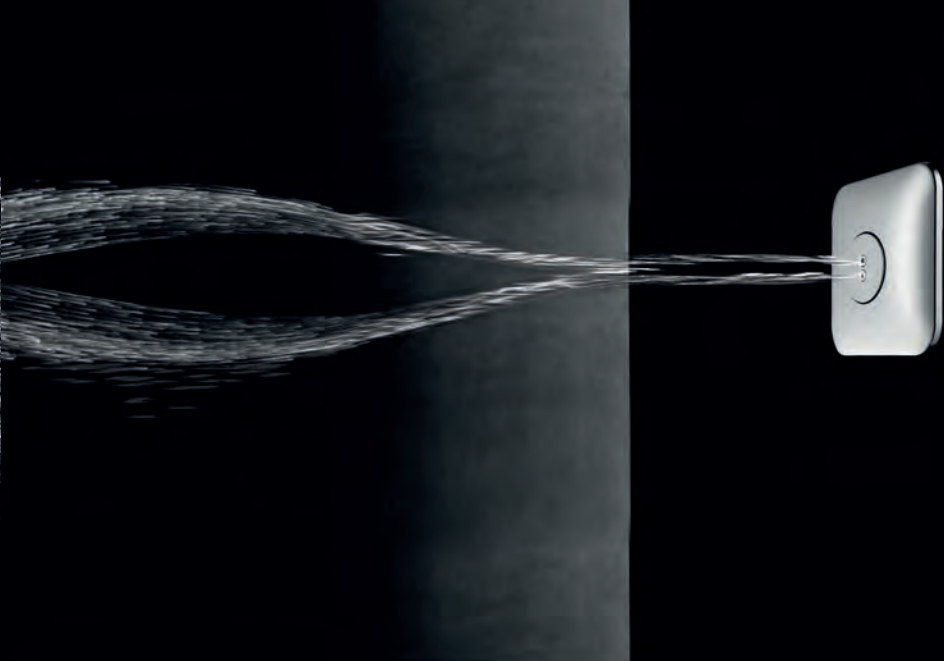

TWISTJET

BJ177 Bodyjet da incasso rotante ABS cromo quadro
Built-in spinning ABS chrome square frame bodyjet



BJ178 Bodyjet da incasso rotante ABS cromo raccordato
Built-in spinning ABS chrome blended frame bodyjet



BJ179 Bodyjet da incasso rotante ABS cromo tondo
Built-in spinning ABS chrome round frame bodyjet



deck showers



70_IN_EASY



Kit di collegamento proprietario all'impianto idrico di bordo tramite innesti rapidi per le colonne doccia e gli accessori della serie Deck Shower

*Water connection dedicated kit
with ghost connection fittings
for shower poles and shower accessories
from Deck Shower collection*

70_IN_EASY_LUX



Kit di collegamento proprietario all'impianto idrico di bordo tramite innesti rapidi e alimentazione wireless per le colonne doccia serie Deck Shower Lux

*Water connection dedicated kit
with ghost connection fittings and wireless power supply
for shower poles from Deck Shower Lux collection*



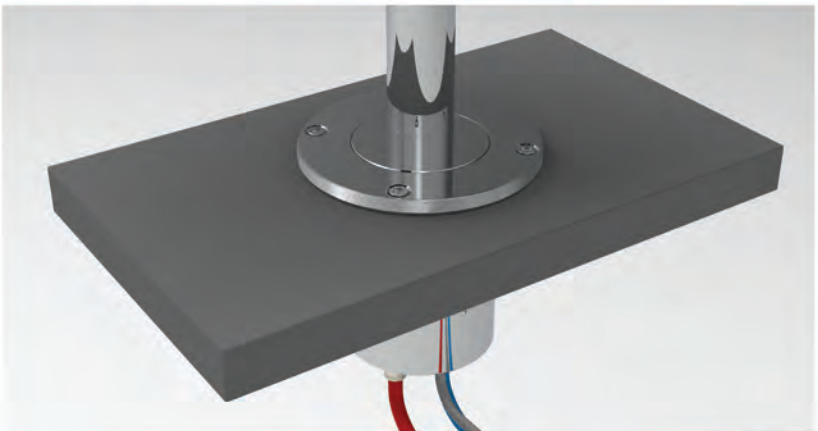
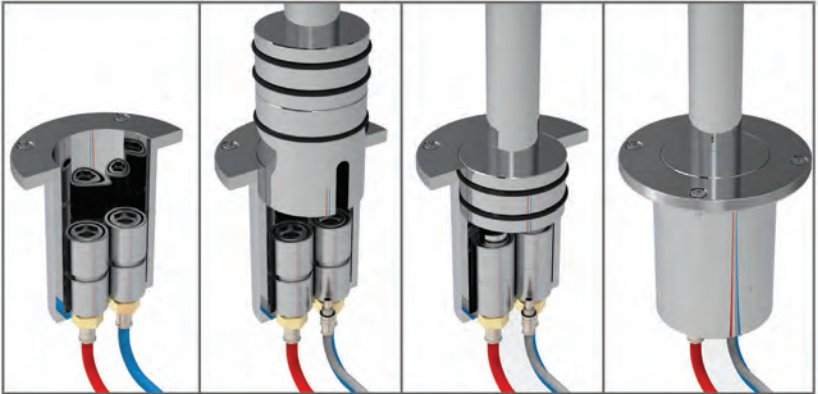
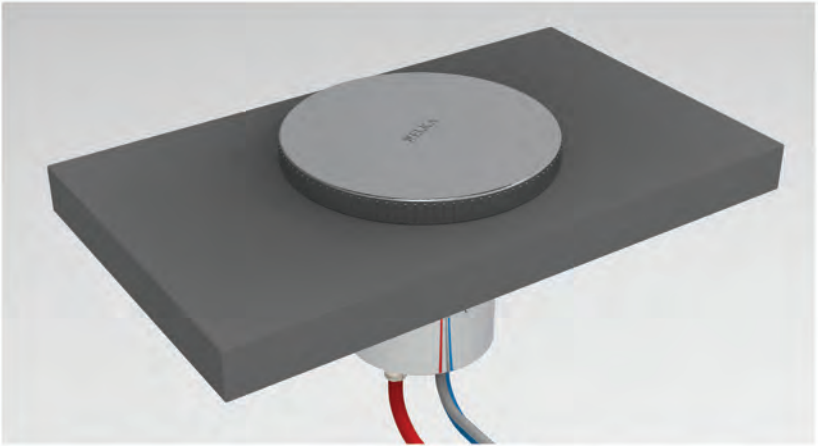



7080GAP

Colonna da ponte rimovibile e
pieghevole con soffione
*Removable and foldable
deck shower with
shower head*

7080GAPC

Colonna da ponte rimovibile e
pieghevole con struttura in carbonio
e con soffione
*Removable and foldable
carbon fiber deck shower with
shower head*





7085P

colonna da ponte rimovibile con soffione
removable deck shower with shower head



7085P_C

Modello 7085P con pali in carbonio
7085 model with carbon fiber poles

7085P_D

colonna da ponte rimovibile con soffione,
deviatore e doccia a microfono
*removable deck shower with head shower,
diverter and hand shower*

7085P_D_C

Modello 7085_D con pali in carbonio
7085_D model with carbon fiber poles



7085H

Portadoccia da ponte rimovibile
con miscelatore acqua calda/fredda,
tubo flessibile doccia microfono
*Removable deck pole with hot/cold water
mixer, flexible hose and hand shower*





Soffione chiuso
Closed head shower



Soffione aperto
Opened head shower

SP_60C

Colonna doccia removibile con struttura
in fibra di carbonio, disponibile nella
finitura lucida o opaca
*Removable carbon fiber shower pole
available in matte or polished finish*

Cartuccia miscelatore progressiva *Progressive mixer cartridge*





Soffione spento
Head shower light off

SP_60AL_LUX

Colonna doccia removibile con struttura in alluminio verniciato, halo led nel soffione con alimentazione senza fili
Removable aluminium shower pole with halo led and wireless power supply



Soffione acceso
Head shower light on



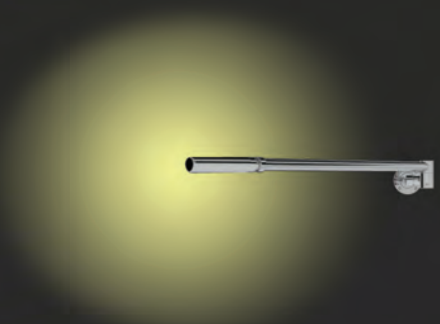

7080GAP_LUX

Colonna da ponte rimovibile e pieghevole
con luce di cortesia sul palo inferiore
e alimentazione wireless.

Richiede kit di connessione 70_IN_EASY_LUX

*Removable and foldable deck shower
with courtesy light, wireless charge.
70_IN_EASY_LUX connection kit required*



SP_30C_DW

Kit di collegamento rapido alla base 70_IN_EASY
removibile per acqua calda/fredda, palo in carbonio
(doccia e tubo esclusi)

*Fast removable connection kit for 70_IN_EASY
socket for hot/cold water, carbon fiber pole
(hand shower and hose excluded)*

SP_30AL_DW

Kit di collegamento rapido alla base 70_IN_EASY
removibile per acqua calda/fredda, palo in alluminio
(doccia e tubo esclusi)

*Fast removable connection kit for 70_IN_EASY
socket for hot/cold water, aluminium pole
(hand shower and hose excluded)*





70_TPC_IR

Tappo a vite per base 70_IN
Screw cap for 70_IN socket

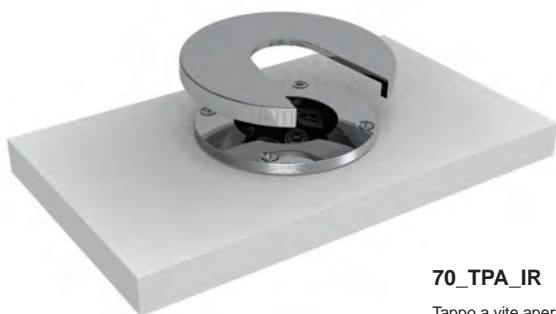

70_TPA_IR

Tappo a vite aperto per base 70_IN
Open screw cap for 70_IN socket

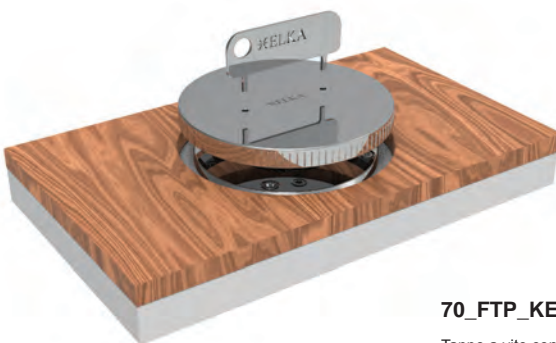

70_FTP_KEY

Tappo a vite con chiave per base 70_IN
installata con recesso
*Screw cap with key for 70_IN socket with
recessed installation*

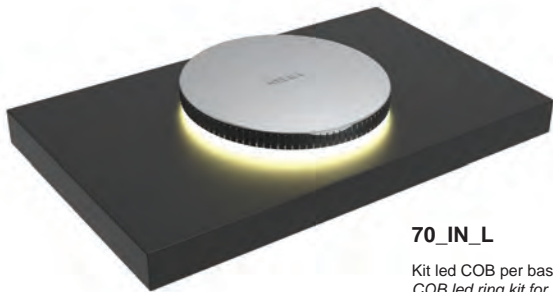

70_IN_L

Kit led COB per base 70_IN
COB led ring kit for 70_IN socket



70_CAPHOL

Supporto per tappo a vite
Screw cap holder



70_BOX_MAXI

Custodia rigida per colonna
Rigid case for shower



pop-up





DO.2017A

Doccia a scomparsa in alluminio con
miscelatore incorporato
*Aluminum hand shower with
concealed mixer*



DO.2017AISI316

Doccia a scomparsa in acciaio AISI 316
con miscelatore incorporato
*Built-in aisi 316 stainless steel hand
shower with concealed mixer*

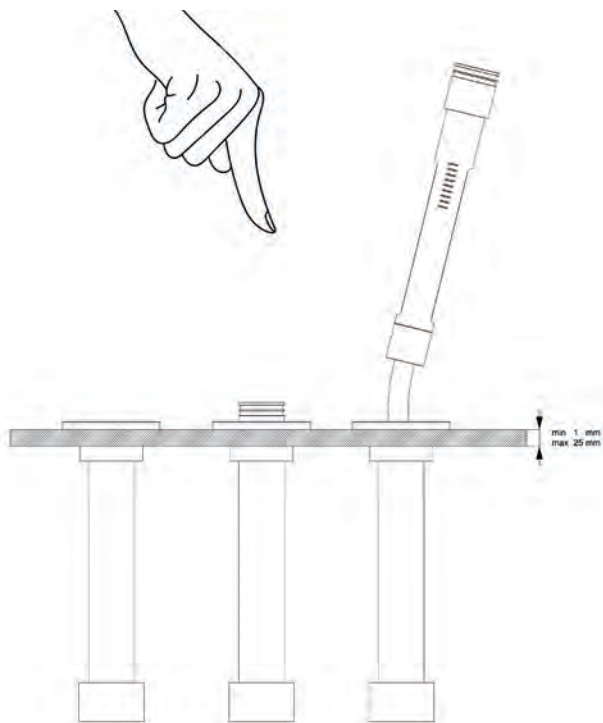

pop-down



pop-up

DO.2017A_TH

Tubo portata acqua premiscelata
Pre-mixed water inlet hose

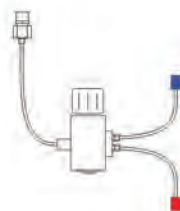
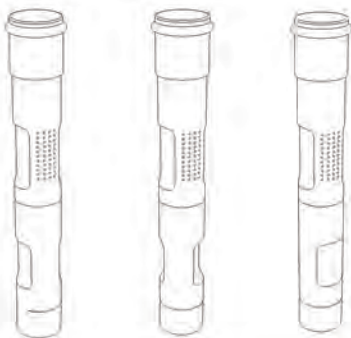

Miscelatore termostatico 31010MT incluso
31010MT thermostatic mixer included



DO.2017A.CW

Solo acqua fredda
Only cold water



DO.552055

Doccia a scomparsa con sistema pop-up in ottone
Brass built-in pop-up hand shower





DO.552055_R_NF



DO.552055_Q_NF

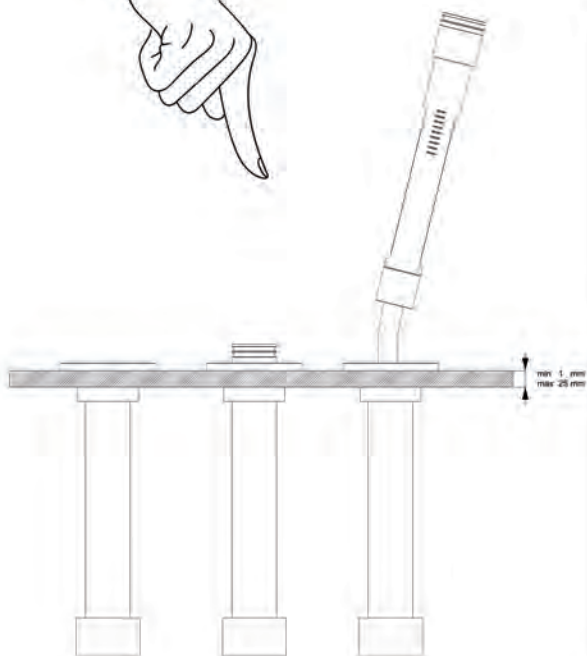

Versioni disponibili
Available options



55055 + 3050

con connessioni per
miscelatore
acqua calda/fredda
with connections for
single lever mixer



55055 + 3015

con connessioni per
rubinetto monoacqua
with connections for
single water valve

parti originali



shut off



DO.2215

Doccia shut off ABS cromo
Shut off chromed ABS hand shower



DO.1000B

Doccia shut off ABS bianca
Shut off white ABS hand shower



DO.1000C

Doccia shut off ABS cromo
Shut off ABS chromed hand shower



DO.2016B

Doccia shut off ABS bianca
Shut off white ABS hand shower

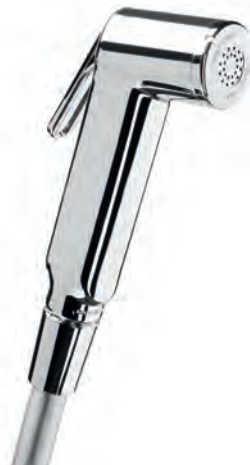

DO.2016C

Doccia shut off ABS cromo
Shut off ABS chromed hand shower

DO.12501

Doccia side pull out ABS
Side pull out ABS hand shower



DO.12511

Doccia side pull out ottone
Side pull out brass hand shower



DO.12900*

Doccia rect pull out ABS
ABS pull out hand shower

* Disponibile con pulsante apri/chiedi o doppio getto
Available with open/close button or jet/spray outlet



DO.5076

Doccia quadra shut-off in ottone
Chrome plated brass square shut-off hand shower

DO.5079

Doccia tonda shut-off in ottone
Chrome plated brass round shut-off hand shower





DO.2800

Doccia shut off ABS cromo
Shut off chrome ABS hand shower



DO.2900

Doccia shut off ABS cromo
Shut off chrome ABS hand shower



DO.85B

Doccia shut off ABS bianca con doppio getto
Shut off white ABS hand shower



DO.5055B

Doccia shut off ABS bianca
Shut off white ABS hand shower

docce



200 - parti originali

DO.6004M

Doccino tondo estraibile da cucina
lunghezza 82 mm ABS
Pull out kitchen shower ABS
82 mm length

**DO.6004O**

Doccino tondo estraibile da cucina
lunghezza 82 mm ottone
Pull out kitchen shower brass
82 mm length

DO.6013M

Doccino tondo estraibile da cucina
lunghezza 134 mm ABS
Pull out kitchen shower ABS
134 mm length

**DO.6013O**

Doccino tondo estraibile da cucina
lunghezza 134 mm ottone
Pull out kitchen shower brass
134 mm length

DO.R001

Doccia rettangolare lunghezza
210 mm ottone
Brass rectangular hand shower
210 mm length

**DO.92SCU**

Doccia rettangolare in ABS
ABS chrome plated rectangular
hand shower



DO.6009 (ottone / brass)

DO.6010 (ABS / plastic)

Doccia quadra
Square hand shower



DO.6011

Doccia tonda lunghezza
183 mm ottone
Brass round hand shower
183 mm lenght



DO.C001

Doccia ovale lunghezza
205 mm ottone
Brass oval hand shower
205 mm lenght



DO.6008

Doccia quadra ABS
slim design
ABS square hand shower
slim design



DO.2047

Doccia ABS cromo monogetto
Single jet ABS chrome hand shower

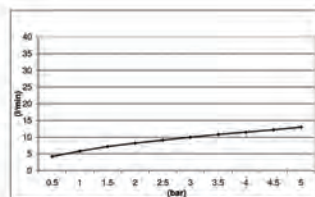
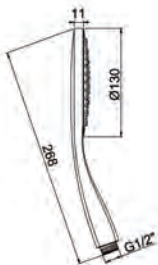

DO.2074

Doccia ABS cromo triplo getto
Three way ABS chrome hand shower

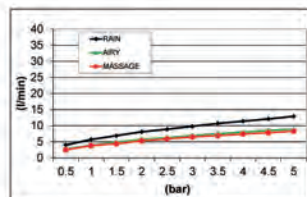

DO.2065

Doccia ABS cromo monogetto
confondello bianco
*Single jet ABS chrome hand shower
with white diffuser*

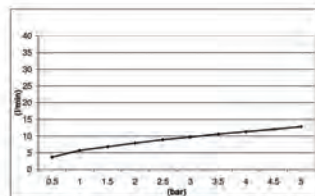

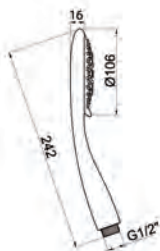
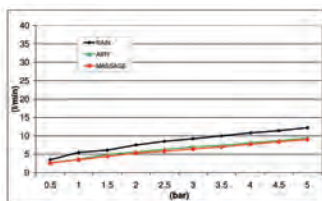

DO.2067

Doccia ABS cromo triplo getto con fondello bianco
Three way ABS chrome hand shower with white diffuser

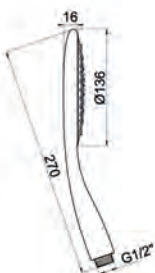
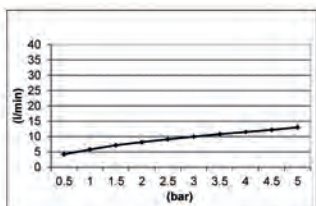

DO.2076

Doccia ABS cromo monogetto con fondello bianco
Single jet ABS chrome hand shower with white diffuser

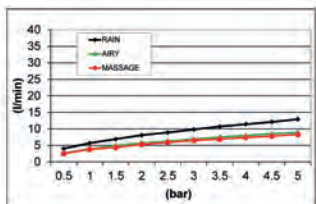

DO.2078

Doccia ABS cromo triplo getto con fondello bianco
Triple jet ABS chrome hand shower with white diffuser





KIT3066

Kit supporto doccia in ottone cromato con
innesto acqua, completo di flessibile e doccia
*Chromed brass bathtub kit, handshower, shelf
with water supply bracket and flexible hose*

prese acqua - supporti



DP.3064

Supporto quadro in ottone con innesto acqua
Square water outlet with hand shower holder

DP.4064

Supporto quadro in ottone con innesto acqua
Square water outlet with hand shower holder



DP.3052

Supporto tondo in ottone con innesto acqua
Round water outlet with hand shower holder

DP.4052

Supporto tondo in ottone con innesto acqua
Round water outlet with hand shower holder





DP.5012

Presca acqua da muro raccordata
Blended frame wall water outlet

DP.5011

Presca acqua quadra
Square water outlet



DP.5009

Presca acqua tonda
Round water outlet



SUP.3050.CL

Supporto da piano cromo
Flat holder

BA.3019TA Ø19
BA.3022TA Ø22
ABS
ABS



BA.3019QA Ø19
BA.3022QA Ø22
ABS
ABS

BA.3099191CR Ø19
BA.3099001CR Ø22
Ottone
Brass



SU.3048

Supporto orientabile ABS cromo
Adjustable square ABS chrome holder



SU.24002

Supporto fisso ABS cromo
Fix square ABS chrome holder

SU.1190 (PLASTIC)
SU.11003 (BRASS)
Supporto orientabile
Adjustable round holder



SU.24006 (PLASTIC)
SU.24006.OT (BRASS)

Supporto fisso
Fix round holder

SU.300/PL

Supporto orientabile ABS cromo
Adjustable ABS chrome holder





FL1212.150

Flex ottone cromo 1/2 C x 1/2 F cm. 150
Flexible hose 1/2C x 1/2F cm 150

FL1212.200

Flex doppia aggr. cromato 1/2 F x 1/2 C cm. 200
Flexible hose 1/2C x 1/2F cm 200

FLP1212A.150

Flex pvc argento cm.150 1/2"C x1/2"F zigrinato
Silver flexible hose 1/2 C x 1/2 F cm 150

FLP1212A.200

Flex pvc argento cm.200 1/2"C x1/2"F zigrinato
Silver flexible hose 1/2 C x 1/2 F cm 200



FL2320G/150

Flex nylon retinato grigio cm.150 1/2"C x 3/8"F
Nylon Grey flexible hose 1/2C x 3/8F cm 150

FL2320G/200

Flex nylon retinato grigio cm. 200 1/2"C x 3/8"F
Nylon Grey flexible hose 1/2C x 3/8F cm 200

CONDIZIONI GENERALI DI VENDITA:

Con il conferimento dell'ordine il cliente accetta pienamente e tacitamente tutte le nostre condizioni di vendita e di consegna sottostanti.

1. PREZZI: I prezzi si intendono per merce franco nostro stabilimento di San Maurizio d'Opaglio. I prezzi dei nostri listini sono soggetti a variazioni e non sono impegnativi. Ogni ordine comunque conferito potrà essere ritenuto valido solo se da noi accettato mediante conferma d'ordine.

2. PAGAMENTI: I termini di pagamento specificati in fattura si intendono tassativi: ogni variazione, che non sia preventivamente ed espressamente pattuita, verrà respinta. Sono liberatori solo i pagamenti delle fatture eseguiti al nostro domicilio in San Maurizio d'Opaglio salvo accordi speciali di pagamenti a termine. Il ritardato pagamento delle forniture darà luogo all'addebito degli interessi bancari. Al verificarsi di pagamenti non eseguiti nei termini convenuti è nostra facoltà sospendere le consegne e gli eventuali ordini già accettati. Si precisa che nessun pagamento potrà essere differito in caso di contestazione.

3. TERMINI DI CONSEGNA: I tempi di consegna si intendono approssimativi e non impegnativi essendo essi vincolati alle possibilità del momento. La mancata osservanza da parte nostra dei termini di consegna è conseguente a carenze di materie prime, avarie del macchinario, scioperi, serrate, epidemia, interruzione o ritardi nei trasporti.

4. IMBALLAGGI: gli imballi vengono fatturati al costo e non se ne accetta la restituzione salvo diversa disposizione; essi sono eseguiti da personale specializzato. Elka srl declina comunque ogni responsabilità.

5. TRASPORTI: La merce viaggia a rischio e pericolo del committente anche se la spedizione è effettuata in porto franco, l'azienda declina ogni responsabilità per ritardi, guasti, avarie, rotture, ammacchi che si verificassero durante il trasporto. Spetta al committente presentare eventuali reclami al trasportatore, anche se questo è stato scelto da Elka srl.

6. RESPONSABILITÀ: Tutti i nostri articoli sono accuratamente controllati e provati. La nostra responsabilità sulla qualità del materiale si limita, previa nostra autorizzazione, ad accettare resi di pezzi riscontrati difettosi per disporre la sostituzione, senza essere tenuti a corrispondere alcun indennizzo. Non possiamo inoltre accettare nessuna responsabilità ove i materiali da noi riforniti risultassero manomessi. Si esclude qualsiasi tipo di risarcimento per danni diretti o indiretti causati dalla posa in opera e dall'utilizzo di materiali difettosi. È fatto assoluto divieto agli acquirenti di effettuare qualsiasi lavorazione ulteriore sui prodotti di nostra produzione. Non riceveremo merce e restituzione se non sarà da noi autorizzata. Le illustrazioni dei nostri cataloghi e depliant hanno lo scopo di rappresentare i singoli articoli e non costituiscono l'obbligo di fedele esecuzione. I dettagli, le misure ed i pesi indicati sono da noi considerati approssimativi. Pertanto non ci assumiamo nessuna responsabilità a quanto sopra e conseguentemente non riconosceremo richieste per danni di qualsiasi specie.

I costi di smontaggio/rimontaggio/spedizione da e per il luogo di installazione e quello di riparazione sono a carico del Cliente

e non possono per alcun motivo essere addebitati, in toto o in parte a Elka srl.

Acquistando un prodotto Elka il Cliente si impegna a non chiedere ad Elka srl danni morali o materiali riconducibili anche parzialmente al malfunzionamento di un prodotto Elka.

7. RECLAMI: Non si accettano reclami dopo otto giorni dal ricevimento della merce che, trascorso tale termine, si intende definitivamente accettata e regolare. Per qualsiasi contestazione e sempre e solo competente il foro di Borgomanero e Novara anche se gli ordini siano stati rimessi altrove. Non hanno alcun valore e non vengono da noi riconosciute dichiarazioni, impegnative o garanzie di sorta assunte dai nostri dipendenti, agenti o rappresentanti, che non risultano dalle presenti condizioni generali di vendita o da atti ufficialmente sottoscritti dalla società. Riserva di proprietà: la merce consegnata rimane di riservato dominio della Elka srl fino all'avvenuto pagamento.

8. GARANZIA: I prodotti Elka, rigorosamente collaudati e provati prima di essere posti in vendita, sono garantiti da difetti di fabbricazione per un periodo di 2 anni (per le finiture cromate) e di 1 anno per tutte le altre componenti a partire dalla data di acquisto del primo acquirente. La garanzia esclude tutti i tipi di cartuccia e di vitone. La garanzia esclude qualunque tipo di finitura diversa da quella cromata.

La garanzia include:

- Difetti di fusione, difetti di porosità, difetti di cromatura.
- La riparazione o la sostituzione del pezzo riscontrato difettoso dopo la verifica dei nostri tecnici e dietro prestazione del tagliando di controllo, a comprova della data di acquisto.

La garanzia decade nel caso si riscontrino:

- Riparazioni e manutenzioni effettuate in modo non idoneo o senza preventive autorizzazione dell'Azienda.
- Utilizzo della rubinetteria in modo non corretto.
- Deterioramento della rubinetteria imputabile ad installazione effettuata in modo non corretto.
- Deterioramento delle superfici con finiture diverse da quelle cromate. La loro durata è infatti subordinata alla cura ed alla delicatezza d'uso da parte dell'utente.
- Deterioramento delle superfici cromate dovuto all'uso di prodotti per la pulizia contenenti acidi o sostanze abrasive, pertanto la Elka srl si raccomanda vivamente di pulire superfici cromate, ottonate o colorate con acqua e sapone, utilizzando un panno morbido.

La garanzia non è rinnovabile. Il presente catalogo annulla e sostituisce quelli precedenti.

È cura del Cliente restituire il prodotto per il quale viene chiesto l'intervento in garanzia in un apposito imballo che ne preservi l'integrità. Danni subiti durante il trasporto comportano il decadimento della garanzia.

Elka srl non è in alcun modo responsabile di danni a cose, animali, persone, causate da utilizzo dei propri prodotti diverso da quello per il quale sono stati progettati e costruiti.

TERMS of SALES

After having placed an order the Client accepts completely and tacitly all our following conditions of sale.

1. PRICES: The prices refer to goods delivered ex-works. The prices of our price-list can be changed and are not binding. Orders are considered as accepted only after the written confirmation of Elka srl.

2. PAYMENT: The payment conditions specified in the invoice have to be considered as peremptory: every change, if no other advanced agreements have been fixed, will be refused. Only the payment of the invoices addressed to our seat in San Maurizio d'Opaglio are liberating, special agreements of payment excepted. Delay of payment of the deliveries will cause the debit of the interest. By payment in not agreed terms we reserve the right to suspend the deliveries and the eventual already accepted orders. No payment can be postponed in case of contestation.

3. DELIVERY TERMS: The terms of delivery are considered approximate and not binding as they are related to the possibilities of the moment. Our non-observance of the delivery terms is due to deficiencies of raw-matters, breakdown of machinery, closing, we have specified near each model the relative contents of master-carton.

4. PACKAGES: The package is invoiced at the cost price and we don't accept the back-delivery if not previously specified, they are prepared by skilled workers. Elka srl declines however every responsibility.

5. TRANSPORT: Goods are forwarded at Consumer's risk, even in case of free destination shipment, our Company declines every responsibility for delays, breakdowns, breakages, deficits that could happen during the transport. The Customer has to present eventual complaints to the transporters, even if it has been chosen by Elka srl.

6. RESPONSABILITY: All our articles are accurately verified and tested. Our responsibility on the material quality is limited, our authorization excepted, to accept the back-delivery, in destination shipment of defective products in way to arrange responsibility in the goods we have delivered, should show operation. It is excluded every kind of indemnity for direct or indirect damages caused by the installation of defective goods. It is absolutely forbidden to the Buyers to do every further working on the products of our product. Return of the goods can be accepted only on authorization of the Company, the photos of our catalogue and brochures are in order to show and present the articles and therefore they do not give duty of accurate execution. The details, sizes and weights have to be considered approximate. So we can not assume any responsibility for what above and therefore we will not accept and claim of damaged of every kind.

Disassembly/reassembly/shipping costs from and to Elka due to a guarantee repair are due to the Customer and can't be charged to Elka srl for any reason.

Buying an Elka's product, is forbidden to the Customer to ask moral or material damages due to a malfunction of a product made in Elka.

7. CLAIMS: Every claim referring of quantity or quality of delivered products must be notified within 8 days after receipt of the goods, after that time it means that it has been accepted definitively. Eventual disputes will be settled in the Court of Borgomanero and Novara even if the orders are sent to other places. Declarations, promises or every kind of assurances from our workers, agent have no value and they are not recognized by us, if they do not follow the present conditions of sale or official communication made out by the Company. Conditional sale: the delivered goods stay on reserved dominion of the Forwarder till the payment is settled.

8. GUARANTEE: The Elka products, accurately verified and tested before selling, are covered by a guarantee from production starts for a time of 2 years (for the chrome finishes) and 1 year for all the other components starting from the date of purchase of the first buyer. The guarantee excludes cartridges, ceramic valves and all the finishes different from the chrome finish.

The guarantee farces:

- Wants of cast. Wants on chromed surface.
- The repairing or the replacement of the article found defective after the checking of on Technical and against presentation of the check-coupon, showing the date of purchase.

The guarantee will not be applied in case of:

- Improper installation or repairing not in conformity with the instruction on Elka srl.
- Improper use of the products.
- Deterioration of the products due to improper installation.
- Deterioration of the special surface different to the chromed ones. Their duration depends upon care and delicacy of the user.
- Damages of the chromed surfaces caused by use of acid, corrosive, abrasive or alcoholic substance for cleaning, so that Elka srl kindly asks to clean the chromed, painted surfaces with water and soft soap and a tender cloth.

The guarantee is no renewable. The present catalogue annuls and replaces all the previous ones.

The Customer has to return the product in an appropriate box. Damages due to the transportation give Elka the chance to deny the guarantee.

Elka is not responsible for damages to things, animals, people, due to uses of its products different from the designed ones.



via Brughiere, 60
28017 S.Maurizio d'Opaglio (NO)
+39 (322) 967-832

ITALY

www.elkasrl.com
info@elkasrl.com

4770 Biscayne Blvd.FL33130
Suite 400
Miami FL 33137
+1 305 868-3600

USA

www.elkadesign.us
info@elkadesign.us

Elka design - tutti i diritti riservati - riproduzione vietata - le immagini hanno lo scopo di rappresentare il prodotto - Elka design si riserva il diritto di cambiare in via migliorativa i propri prodotti senza preavviso - le immagini appartengono ai rispettivi proprietari.

Elka design - all rights reserved - forbidden reproduction or unauthorized use - images are to represent the products - Elka may change or improve the quality its products without any advice - images rights of respective owners.

