

*Industrial HVLS  
Commercial Series*  
**AV15**

**BLUECO**

Save Energy, Stay Cool

2855 N Sunnyside Fresno CA, 93727 Phone: 559-392-8194

[www.Bluecobrand.com](http://www.Bluecobrand.com)

Instruction Manual

—Commercial HVLS fan

**BLUECO**

---

**CONTENT**

Instruction	2
Disclaimer	3
BLUECO Commercial Fan Assembly Diagram	4
General Safety Information	5
Product Introduction	6
Pre-installation	9
Installation Steps	11
Check, Adjust & Debug	18
Operation Guidelines	19
Maintenance & Service	20
Trouble Shooting	21

---

**INSTRUCTION**
**To our respected users**

Thank you very much for purchasing and using BLUECO Series commercial HVLS (High Volume, Low Speed) fan.

This Instruction Manual mainly serves the installers and daily users of BLUECO Commercial fan, for installation, daily use, routine maintenance. The possible problems and precautions in troubleshooting are systematically explained and directed.

Please read this instruction manual carefully before installation and operation, to comply with the relevant national safety regulations and the installation process of this manual, safe and efficient use of BLUECO commercial fans.

In the course of daily use, if you encounter any problem or malfunction not involved in this article, please call the service phone of BLUECO or contact with local authorized dealer.

### Disclaimer

#### Disclaimer

BLUECO reserves the right to make alteration to appearance, structure, design, manufacturing technology, etc. for production or other reasons subsequent to publication. The information contained herein has been prepared by qualified experts within BLUECO .

While we believe the information is accurate and complete, we make no warranty or representation for any particular purposes. The information is offered in good faith and with the understanding that any use of the units or accessories in breach of the directions and warnings in this document is at the sole discretion and risk of the user.

### BLUECO Commercial HVLS fan assembly diagram

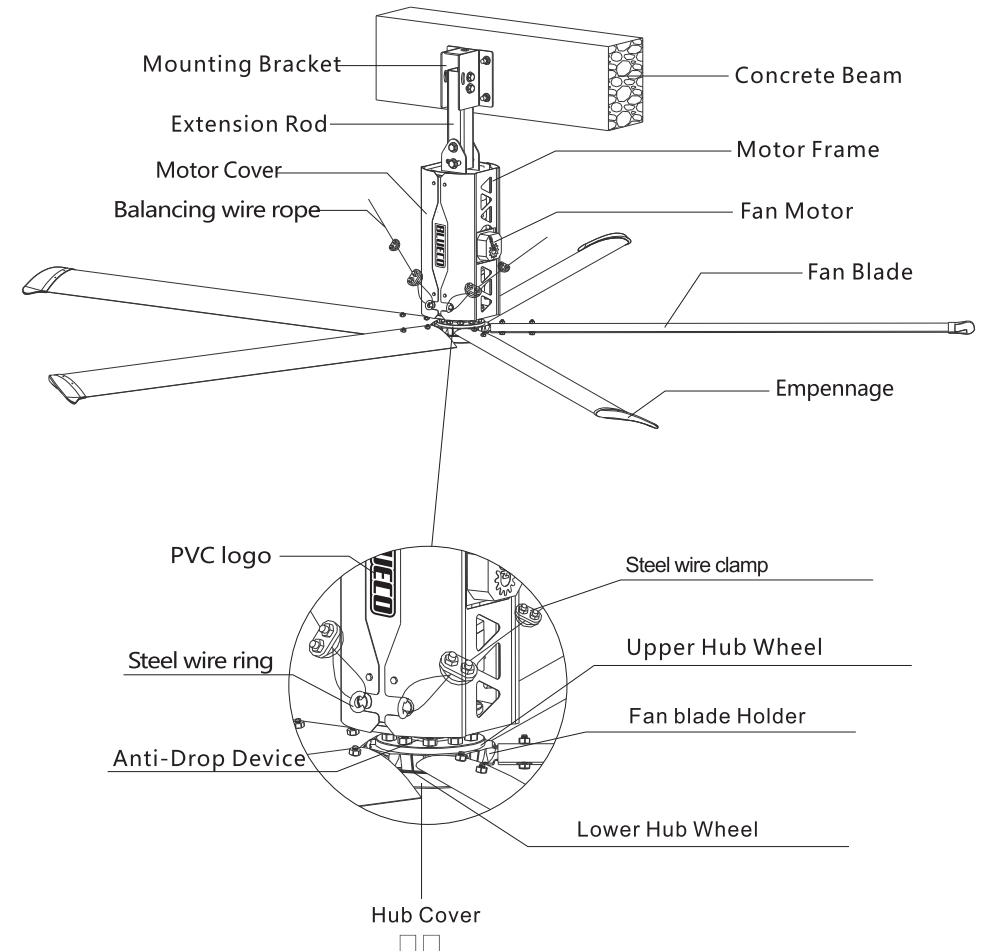

## General Safety Information

### 1.1 General warning

BLUECO Commercial fan A V 1 5 Series are usually installed on steel structures or concrete beams, with a self-weight of about 50kg. The user shall ensure that the structure of the building can withstand the weight of the fan and the torque of about 50Nm due to the rotation of the fan. In order to ensure the safety of operators under and around the fan, if it is observed that the fasteners of the fan are loosening, falling off, or the abnormal sound is heard while the fan is in operation, and the main body of the fan, especially the blade, is found to be defective, etc. Please slow down and switch off the fan immediately, then inform BLUECO or local authorized dealer.

### 1.2 Installation warning

Any installation personnel must pass installation and safety training from BLUECO or authorized dealer before installation/operation. It is a Must to follow up with national or local safety regulations, to put on necessary safety protection wears or equipment during installation work; and ensure the climbing device is stable and reliable; set up a striking mark within the scope of the operation during installation to avoid the entry of unrelated personnel enter the area; Before installing the electronic control box and other electrical equipment, the power must be cut off and clearly marked at the power source under construction.

### 1.3 Maintenance warning

The power supply must be cut off before the maintenance operation and the maintenance operation should be clearly marked; the appropriate safety protection equipment must be worn when the climbing operation is required to ensure that the climbing facilities are stable and reliable; Be sure to protect the safety of passers-by below the fan installation area, and set up warning signs or pull safety warning bands if necessary.

## Product Introduction

### 2.1 Principle

An BLUECO HVLS(high-volume, low speed) fan is a super large ceiling fan with a diameter range from 7.3m(24ft) to 3.0m(10ft). The airfoil blade are streamlined which was developed with the technologies and advantage of aerodynamic. Just with a power 0.55kw~1.5kw or less to move a mass of air and produce a larger scale of natural wind to all directions. The air passes over human skin thereby bring a lower temperature sensation, while air exchange with outside fresh air rapidly through the window or roof ventilator, reducing the turbid air and providing people a comfortable environment.









### 2.2 Application

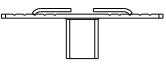

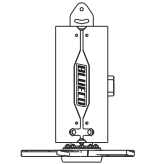
BLUECO Commercial HVLS fan is widely used for any large space applications which is higher than 4.0 meters such as logistics center, factory, shopping center, terminal station, cattle farm as well as agriculture applications,etc.

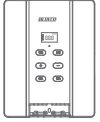

### 2.3 Specification

Model	Fan Dia. ( M/FT )	Motor Power ( kW )	RPM	Air Flow ( m <sup>3</sup> /min )	Current 380V/220V ( A )	Weight ( KG )	Noise ( dBA )
AV15	4.0/14	0.55	40-102	8,000	1.52/2.63	50	40

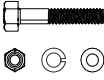
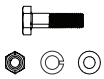
2.4 Packing List

	Mounting Bracket *1set (as required)		Safety Cable *15M
	Drive device *1pc		Extension Rod *1pc
	VFD Controller *1pc		Fan blade *5pcs
	Power Cable *15M		Empennage *5pc
	Hub Cover *1pc		

	M12 x 90mm *4pcs Hex Head Cap Screw M12 Nylock Nut *4pcs M12 Spring Cushion *4pcs M12 Flat Washer *8pcs
	M8 x 40mm *10pcs Hex Head Cap Screw M8 Nylock Nut *10pcs M8 Spring Cushion *10pcs M8 Flat Washer *20pcs
	M6*14pcs Steel wire clamp

	Tapping screw 5*16mm *10pcs
	Flat head tapping Screw 3.5*35mm*4pcs Plastic wall plug*4pcs

\*It equips the different screws for H beam, Concrete beam and Rigid frame beam.

H Beam	M12 x 50mm *4pcs Hex Head Cap Screw M12 Nylock Nut *4pcs M12 Spring Cushion *4pcs M12 Flat Washer *8pcs
	M10 x 80mm *10pcs Expansion Screw (For Concrete Beam)
	M8 x 100mm *4pcs Expansion Screw (For Concrete Beam)
Rigid Frame Beam	M12 Nylock Nut *8pcs M12 Spring Cushion *4pcs M12 Flat Washer *8pcs M12 Threaded Rod 1Meter

## Pre-Installation

### 3.1 Unpack and inspection

Please check the status and quantity of the fan equipment and the supporting parts immediately after you opened the case to make sure that the goods you received are in accordance with your order.

### 3.2 Installation precautions

The maximum weight of the fan is about 50kg and the maximum torque is about 50N m. The clearance from the fan to the roof (no matter what the roof structure) is the distance between the location of the lowest part of the fan (nearest to the ground) and the installation of the upper connecting frame of the fan. For the inclined roof, the required distance should be moved to the tip of the blade, otherwise, it may cause the blade tip to collide with the roof or affect the smooth flow of airflow because the distance between the roof and the blade is too short. Overall, it is necessary to maintain reasonable fan blade and roof space to ensure wide air flow.

### 3.3 Positioning

With the increase of fan speed, the fan blade will move upward along the diameter of a certain angle, increasing the fan coverage area. Therefore, all obstacles that may be encountered within the radius of the fan and between the horizontal height of the fan's static position and the ceiling should be measured before installation, ensuring that the fan has an appropriate clearance in all directions when running (see figure3.3). It had better to ensure that the fan and the existing facilities of the building (horizontal and vertically) with gaps above 300mm.

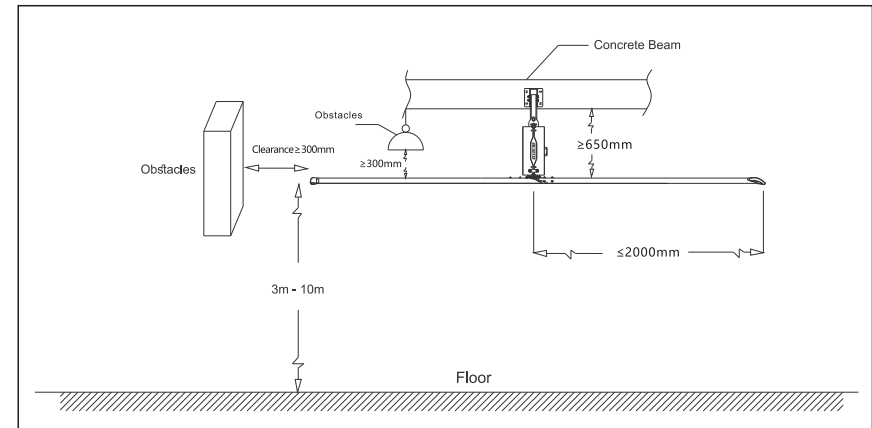

fig3.3

### 3.4 Mounting Installation Methods

Each type of building structure requires a specific mounting bracket, the Commercial series HVLS fan can only be hung from standard mounted with an H-Beam, Rigid frame beam or Concrete beam. For buildings with a different installation structure, an additional set of brackets can be customized from factory, please consult BLUECO or local authorized dealer.



- Verify with the contractor, building owner or structure engineer to ensure the building structure is sound and adequate to support the load before installation.
- Taking measurement of the height of the booth of structure beam and blade level.
- Check if the power supply is correct on site.

### 3.5 Installation Tools

Levelling instrument, Cutting Plier, Wire stripper, Lifting device(Scissor lift or the scaffold or ), Plier, 4 sets of tightener(or turnbuckle screw), cross screwdriver, straight screwdriver, Tapeline, Marking pen, Hand electric drill with M4.2 bit. Out hexagonal wrench: 8mm/10mm/13mm/14mm/16mm/17mm/18mm/19mm  
 Note: A hand electric drill with 10mm and 12mm drill bit will also be required when mounting bracket to Concrete beam.

### Installation Steps

#### 4.1 Connect to building

##### 4.1.1 H-beam

Connect with Steel H-Beam by adjustable standard clip device, the fan can be easily clip on any steel H-beam, without changing any steel structure.The device can be adjusted according the width of the beam(80mm-220mm). (figure 4.1.1)

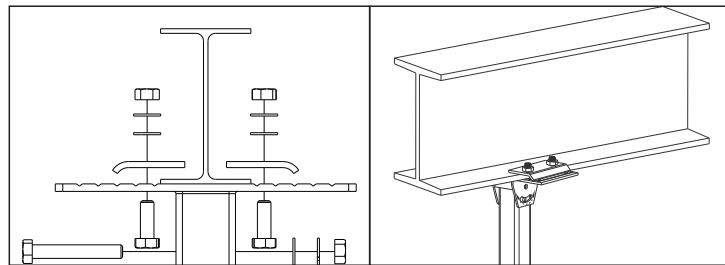

fig4.1.1

##### 4.1.2 Concrete beam

Connect with concrete beam, the standard device is fixed by expansion bolts on the side and bottom of concrete beam, the device can be adjusted according the width and height of the beam. (figure 4.1.2)

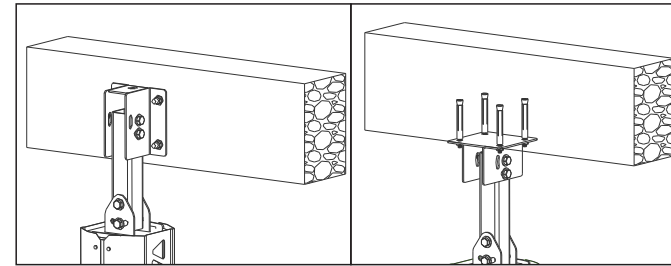

fig4.1.2

#### 4.1.3 Rigid Frame beam

Connect with Rigid Frame Beam, the standard device is fixed by threaded rod on the rigid frame beam. Cut the threaded rod into 4PCS base on the height of the rigid frame beam. the device can be adjusted according the width of the beam(80mm-240mm). (figure 4.1.3)

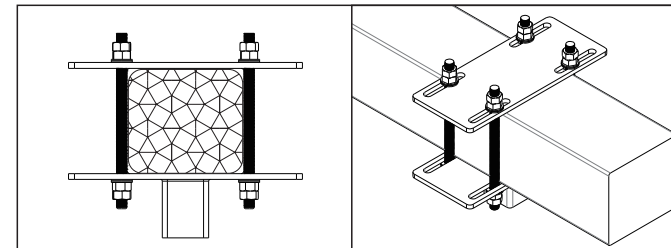

fig4.1.3

#### 4.2 Extension Rod Installation

The length of extension rod is customized according to the actual situation of building, it is used to adjust the installation height of fan. Connect the ends of extension rod with Mounting Bracket and drive device by bolts.(fig4.2)

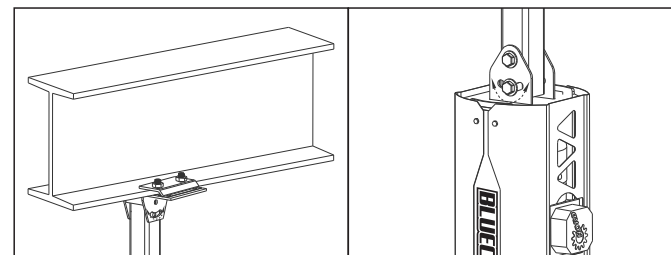

fig4.2

### 4.3 Drive device installation

**4.3.1** The drive device has been assembled to be one unit before delivery, fix it to the extension rod by using bolts, and use the adjustable arc-shaped groove to make sure the drive device at a vertical level position (Fig 4.3.1).

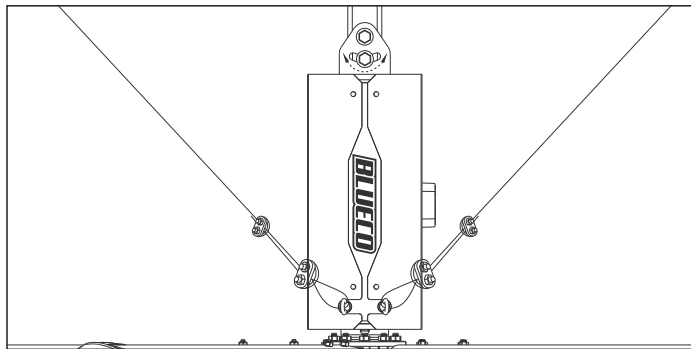
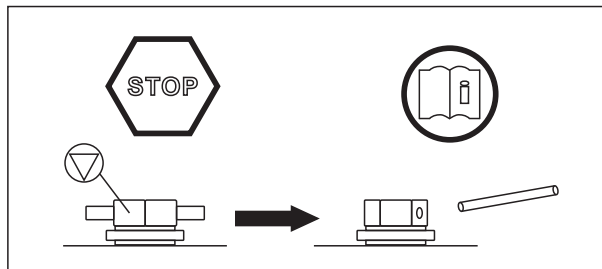

fig4.3.1

**4.3.2** The drive device is heavy, need 2-3 people or use lift to install.



Do not remove oil plug until fan is properly mounted. If the oil plug is removed before the fan is mounted, oil in the gear box reducer may spill out.



### 4.4 Connect to power supply and wiring

**4.4.1** The wire sleeves are arranged along the building pillars and the top along the building structural beams.

**4.4.2** The wire conduit layout should be done as short and simple as possible.

**4.4.3** Before wiring, please make sure the power is off. Then connect with power supply. If the factory power supply is 380V, motor is wired according to the y-type wiring method; If the power is 220V, motor is wired according to  $\Delta$  type. Connect motor wire first then connect the electric wires to the control box.



Don't connect the power supply to motor directly.

### 4.4.4 Circuit Diagram (380V/220V)

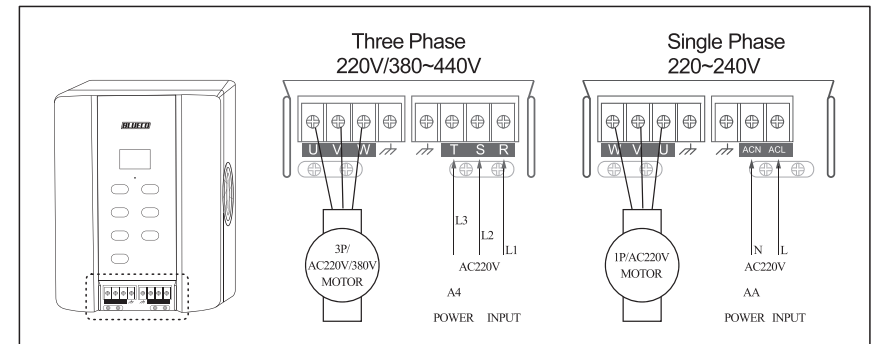



#### 4.5 Installation of balancing wire rope

Each fan has 4 steel wire ropes. Please ensure the angle between each steel wire and the drive device is 45 degree, too big or small angle will affect the strength of the steel wires. Please adhere to the following guide lines:

##### The first method with turnbuckle:

**4.5.1** Attach the balancing wire rope before you install the blades

**4.5.2** Use four safety cable per fan, with 3 clamps per rope. (one clamp for building structure, two clamps for turnbuckle)

**4.5.3** Use the closed-end of turnbuckle to fix the steel wire to the building structure, and use the open end of turnbuckle to fix the steel wire to the safety ring of fan.

Caution: It is important to avoid wrapping the steel wire around the sharp corner. Although the external force used to fix and balance the fan is very small, the continuously running of fan may cause fatigue damage to the steel wire rope in the severely curled place.

**4.5.4** Attach the steel wire to the build structure first, install one clamps per wire. Go ahead and tight them, so that part of the job is completed.

**4.5.5** Attach the steel wire to the closed-end of turnbuckle, and use the open-end of turnbuckle to fix on the safety ring of fan, install two clamps per wire.

**4.5.6** Using the turnbuckle to tighten each steel wire rope gradually, and use the leveling instrument to make sure the drive device of fan at a vertical level position.

##### The second method with tightener:

**4.5.7** Attach the steel wire to the building structure first, install one clamps per wire. Go ahead and tight them, so that part of the job is completed.

**4.5.8** Attach the steel wire to the safety ring of motor frame, install two clamps per wire, do not tight the screws.

**4.5.9** Using the tightener to tighten each steel wire rope gradually, while using the leveling instrument to make sure the drive device of fan at a vertical level position. Then lock the clamp screw near to motor of each steel wire, loose the tightener and lock the end clamp screw immediately.

Caution: The key is to make sure each wire rope has the same tightness after installed.

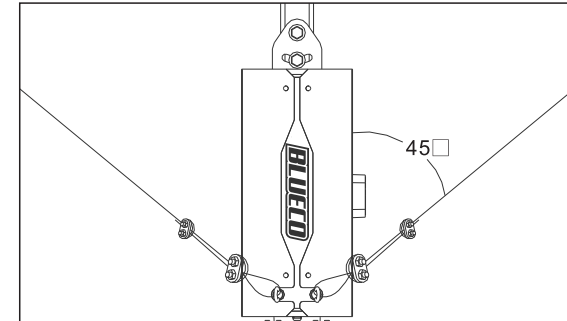
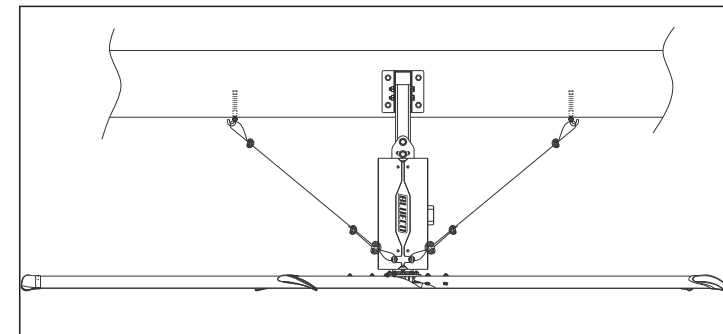

fig4.5



#### 4.6 Empennage Installation to fan blade

Insert the empennage to each airfoil blade and fix it by using bolt.(Fig4.7)

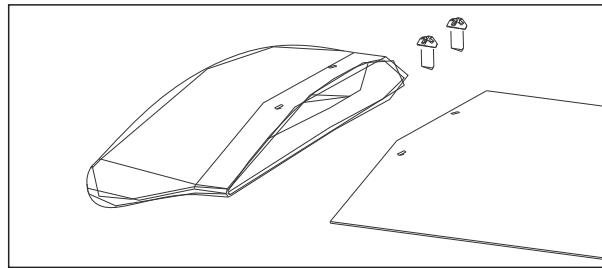

fig4.6

#### 4.7 Fan blade installation

4.7.1 The fan blade pin has been installed onto the fan wheel hub, just insert the airfoil blade onto the blade pin and fix it by bolts. The correct direction of blade installation should be the blade upwind surface (thick, round part of the blade) the highest, blade leeward surface gradually downward. (fig4.7)

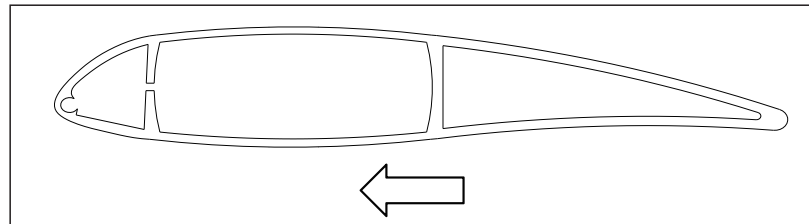

fig4.7 The right direction of rotation

#### 4.8 Hub cover Installation

Take the Hub cover close to the hub wheel and tighten it by buckle.

### Check & Adjust & Debug

#### 5.1 Check connection bolts

Upon completion of the above installation steps, double check and ensure that all fastening bolts are provided by BLUECO and are properly installed and fastened.

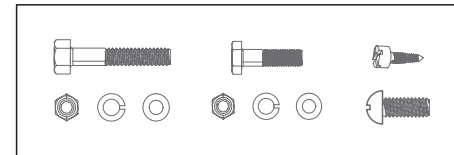

#### 5.2 Inspection on tension of Steel wire

Check if the wire rope around the beam is installed correctly, make sure the rope head is locked; and double check tensioning degree of the four fastening wire ropes to ensure the perpendicularity of the motor support and the balance of the chassis.

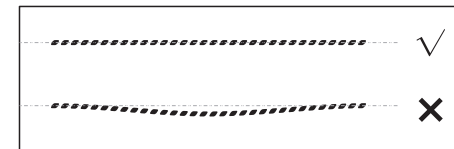

#### 5.3 Fan blade condition check

The fan blade is made of aluminum alloy material with special fluorocarbon baking paint treatment. Please handle with care during installation to avoid scratches, crash or deformation. Any damage on fan blade might cause noise during operation. In case any damage occurs, contact BLUECO or local distributor/dealer to replace fan blade.

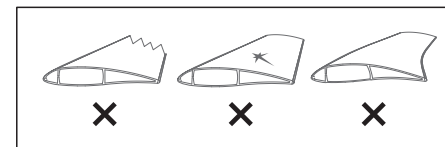

## Operational Guidelines

### 6.1 Controller panel and functions



BLUECO 2022 CONTROLLER

- ON/OFF** Start or Stop the machine
- ENTER** Confirm and save the parameters setting
- SETTING** Parameters setting
- TIMER** Clock and Timing settings
  - + for increase speed and parameters setting
  - for reduce speed and parameters setting

### 6.2 Start-up Industrial HVLS Fan

- Switch on the air switch in the box to connect with the power supply.
- Press the ON/OFF key and star the machine.
- Remain the fan speed in low speed for 30 seconds and then Press the + or - key to the required speed.

#### Cautions

- Read the **Instruction Manual** carefully before installation and operation and make sure that the fan is not obstructed in all directions.
- Before the HVLS fan is repaired and maintained, please make sure that the power has been disconnected.

### 6.3 Display icon description



- ① Speed icon, Divide the minimum speed to the maximum speed into 12 equal parts, which are displayed according to the actual speed setting data, and fixedly displayed during operation.
- ② Speed icon, When the data display area is the speed, the icon displays.
- ③ WiFi icon, The icon is displayed when connection is normal; is not displayed when disconnected and flashes when it is not set.(Temporarily unavailable)
- ④ Timer icon, during the time setting and countdown, the icon keeps showing.
- ⑤ Clock and Timer display, show real-time clock, initial clock is: 12: 00, 24 hours mode. This area displays the countdown time when timing is turned on.
- ⑥ Data Display, display Running Data and Setting Data.
- ⑦ Parameter display icon.
- ⑧ Two-color indicator light: red when standby, green when running, flashing red when malfunctioning.

## 6.4 Electrical faults and solutions

Error code	Error name	Troubleshooting	Handling method
E00	Maintenance tips	Operated for more than 15000 hours	Maintain the equipment
E1	Overcurrent protection	Short circuit or leakage in the motor	Replace the motor
		Frequency converter parameter setting error	Adjust frequency converter parameters
		Sudden change of motor parameters	Replace the motor
		Internal fault of frequency converter	Depot repair
E2	Overvoltage protection	Input voltage too high to +15% of rated value	Adjust input voltage to the rated value
E3	Undervoltage protection	Input voltage too low to -15% of rated value	Adjust input voltage to the rated value
		Internal open circuit of motor	Replace the motor
E4	Phase failure protection	Poor contact of motor UVW wire	Adjust wiring
		Phase loss of input circuit	Check the line
E7	Overload protection	Excessive load or locked rotor	Check type of accessories and structure
		Unsuitable motor	Replace the appropriate motor
E8	Overheat protection	Too high temperature for operating	Reduce ambient temperature
		Air duct blockage	Clean the air duct
		The cooling fan is damaged	Replace the motor cooling fan
F6	Communication failure	Connection exception of panel and board	Reseat or replace
		Circuit failure	Depot repair

## Maintenance &amp; Service

SN	Maintenance & Service
1	Visual fan running state
2	Control box working state
3	Check the status of the fan blade
4	Check the tension of suspension wire rope
5	Check fin and fan blade firmness
6	Check whether the flange bolt of motor is fastened
7	Clean the leaf (be careful not to damage it)
8	Check the fastening bolts of the connecting frame
9	Check whether the flange screw of motor is fastened
10	Check the oil level of reducer tank
11	Check anti - release lock catch
12	Check fan suspension
13	Check the safety rope on the beam
14	Check welding position
15	Check motor supports and fastening bolts

## Trouble Shooting

### 8.1 The fan is running in wrong direction

The power phase sequence is not correct, change the wiring again.

### 8.2 Popping noise comes from the fan

The fan blade popping noise may come from the blades are not tightened to the specified torque, cut off power at Controller panel and tighten the fan blade fastener to the specified torque. If popping noise still occurs, please check the connection between fan blade and Hub. If the connect is ok, please slow down and switch off the fan, then contact BLUECO or local authorized distributor.

### 8.3 The fan is not working

- Make sure that all wires are securely connected.
- Make sure the Controller panel operates normally.
- Verify the supply power is adequate and functional.

### 8.4 The motor makes noise when you speed up the fan

Audible high frequency noise is normal during fan operation, if it exceeds your acceptable range, or you feel that the noise maybe a result of mechanical failure, please contact with BLUECO or local authorized distributor.

### 8.5 Internal fault of Controller or Controller converter

According to Part 6.4, **Electrical faults and solutions**, please query and handle according to the error code solution. If the error code can not be solved, please contact BLUECO or local authorized distributor.

### 8.6 The trouble shooting of gearbox and motor

please follow the problem solving instruction of NORD. If not, please contact BLUECO or local authorized distributor.