

LIMITED WARRANTY COVERAGE

1 YEAR LIMITED WARRANTY

DeerValley products are made with quality materials and excellent craftsmanship to provide the customers a long-lasting product. In the case of any defects in materials or craftsmanship under regular use were inspected in the first one year of delivery, DeerValley will provide replacement parts at no charge, or at its option, replace any product or part of the product that is deemed defective, under normal installation, use, service and maintenance. This warranty applies only to the original purchaser. Proof of purchase will be required in the case of a claim. **SCRATCHES ARE NOT COVERED UNDER WARRANTY.**

The manufacturer warrants this product to be free of manufacture defects during the above mentioned warranty time. Please keep a copy of the original invoice as proof of purchase.

DeerValley will, as its option, (1) repair or replace the defective part(s) or product(s) at no charge; (2) issue a refund of the original purchase price of the product(s) (Valid within 30 days from the date of delivery); or (3) issue a credit to be applied toward the purchase of a new DeerValley product shipping/delivery charges may apply and are in DeerValley sole discretion.

DeerValley recommends the installations to be made by a licensed, professional plumber. DeerValley will not be held responsible for any damage or product failure due to improper installation, misuse, or failure to use a licensed professional. DeerValley is not responsible for any removal or installation cost.

This limited warranty shall not apply to goods which have been subject to accident, negligence, improper installation, product abuse, product misuse, or use of cleaners containing abrasives, alcohol or other organic solvents, whether performed by a contractor, service company, or yourself, are excluded from this warranty.

DeerValley responsibility under this limited warranty is limited to only to replacement parts and no other costs. DeerValley will not be responsible for labor charges and/or damage incurred by installation, repair or replacement, nor for any indirect incidental or consequential damages, losses, injury or costs of any nature relating to this product Except as provided by law, this limited warranty is in lieu of and excludes all other warranties, conditions, and guarantees, whether expressed or implied, statutory or otherwise, including without restriction those merchantability of fitness for use.

RESPONSIBILITIES OF OTHERS

Inspecting the unit prior to installation is the responsibility of the installer or building contractor who acts on behalf of the user. They are responsible for ensuring the unit is free of defect or damage.

Notices are placed on and in the unit and on the shipping carton advising the installer of this responsibility.

In the event of a problem, the unit must not be installed. DeerValley is not responsible for failures or damage that could have been discovered, repaired, or avoided by proper inspection and testing prior to installation.

Damage occurring in transit is the responsibility of the carrier. The user or installer **MUST** open the crate and inspect the unit for damage when it is delivered. If damage is discovered, it must be reported immediately to the seller and the carrier in writing, and an inspection requested. Failure of the carrier to respond should be reported to the seller and the carrier. Your freight claims should be filed promptly thereafter.

LIMITATIONS AND EXCLUSIONS

This warranty does not cover instances of negligence, misuse, abuse, improper installation, carelessness, accident, hard water or mineral deposits, exposure to corrosive materials, misapplication, damages caused by improper maintenance, alteration of the product, or failure to follow care or installation instructions enclosed with your product. This warranty is void if the DeerValley is subject to alteration, or if repairs are attempted by anyone other than an authorized agent of DeerValley. This warranty does not extend to plumbing or components installed by dealers, installers or by any party other DeerValley.

DeerValley will not be liable for loss of use of the DeerValley inconvenience, or any other incidental or consequential costs, expense or damages. Please note that some states do not allow the exclusion or limitation of incidental damages.

DISCLAIMER

Except as expressly provided, there shall be no warranty or obligation, express or implied, oral or statutory. No dealer or other person has the authority to make any warranties or representations concerning DeerValley or its products. In no event shall DeerValley be held responsible for any such warranties or representations.

WARRANTY SERVICE

NOTE: When requesting warranty, be sure to have the following:

- Copy of original invoice
- Date of installation
- Description and pictures of defect
- Model number or description of model

To obtain warranty service and replacement part, please contact DeerValley Customer Service. DeerValley will determine whether to repair or replace your product, issue a refund, or issue a credit.

Smart Toilet (DV-1S0160 & DV-1S0160-V3)

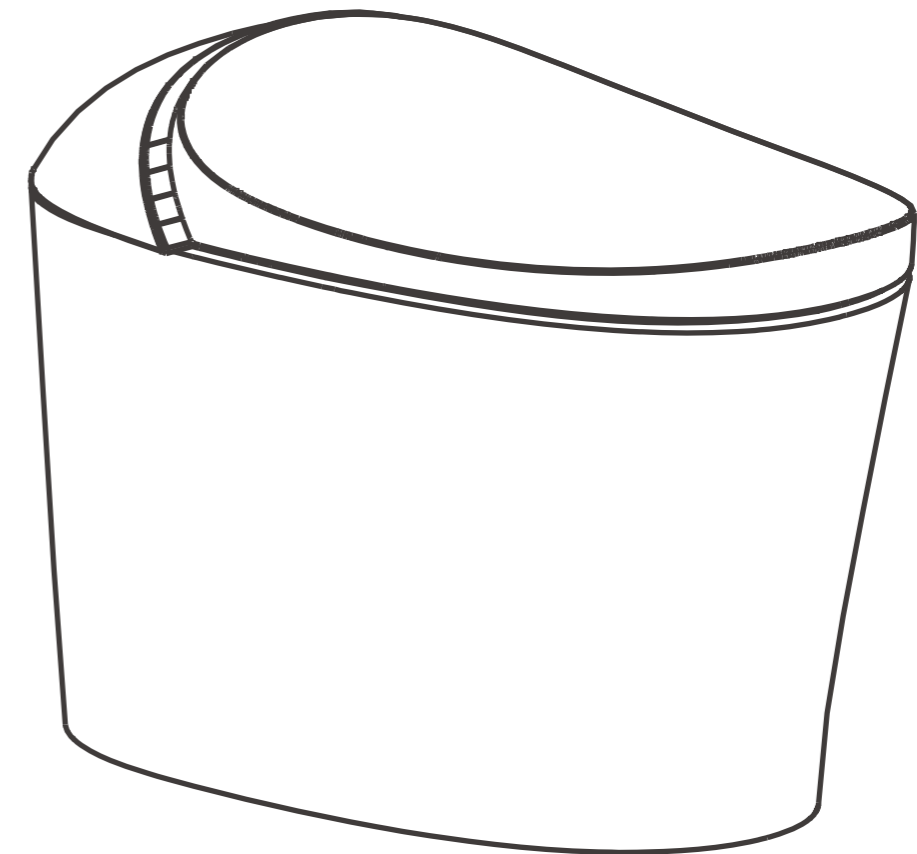

NOTE: Drawings may not exactly define contour of the product.

• Troubleshooting

Product part or function	Phenomenon	Cause	Solutions
Complete machine	Not working	Whether the power supply is off	Power on
		Whether the leakage protector is off	Press the leakage switch again
		Power failure or not	Wait for power supply
Rear wash / Front wash	Not working	Whether the water supply switch is on	Turn on the water supply switch
		Whether the water supply is cut off	Wait for water supply to recover
		Whether the nozzle is blocked by foreign matters	Remove foreign matters and manually clean the nozzle
		No skin contact with seat sensor	Re-adjust sitting position to ensure skin contact with sensor
	Low water pressure	Is the water pressure gear set to low gear	Reset the water pressure gear
		Whether the water supply channel is normal	Clean the filter screen at the water supply outlet and supply water again
	Water temperature is low	Whether the water temperature is set to low gear	Reset the water temperature gear
	Stop water halfway	Whether the automatic stop time is exceeded	Re-execute the function
No skin contact with seat sensor		Re-adjust sitting position to ensure skin contact with sensor	
Warm air drying	Low heating temperature	Whether the wind temperature gear is set to low gear	Reset the water temperature gear
	Half-way stop	Whether the automatic stop time is exceeded	Re-execute the function
		No skin contact with seat sensor	Re-adjust sitting position to ensure skin contact with sensor
Seat ring heating	Insufficient seat ring temperature	Is the seat temperature gear set to low gear	Reset the seat temperature gear
Deodorization	Not working	No skin contact with seat sensor	Re-adjust sitting position to ensure skin contact with sensor
Remote control	No reaction	Objects cover the sensing window	Remove the objects
		Incorrect use angle and sensing distance	Adjust angle and distance
		Batteries run out	Replace with new batteries

NOTE: Drawings may not exactly define contour of the product.

TABLE OF CONTENTS

● Safety Precautions	02
● Technical Specifications	05
● Pre-installation	06
● Installation	08
● Remote Control Installation and Battery Replacement	11
● Side Button Operation	12
● Remote Control Instructions	13
● Automatic Fuction	19
● Daily Maintenance	20
● Label Illustration	22
● Troubleshooting	23



Prior to Installation:

- Inspect toilet to ensure no damages have occurred while in shipping.
- Observe all plumbing and building codes in accordance with your state and local requirements.
- Remove old toilet.
- Make sure mounting surface is CLEAN and LEVEL.

General Recommendations:

Please read installation and maintenance instructions thoroughly before installing the toilet.
Be sure to use proper tools and always wear proper personal safety accessories for your protection.

**If you have any questions or concerns
please contact us:**

(+1) 312-626-9466
service@deervalleybath.com

When water and electricity are cut off

1. Flushing during power outage (under the condition that the spare battery box is connected and has filled battery)

Long press the side button to flush.

Manual flush button

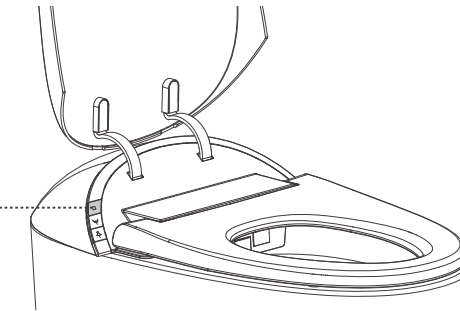

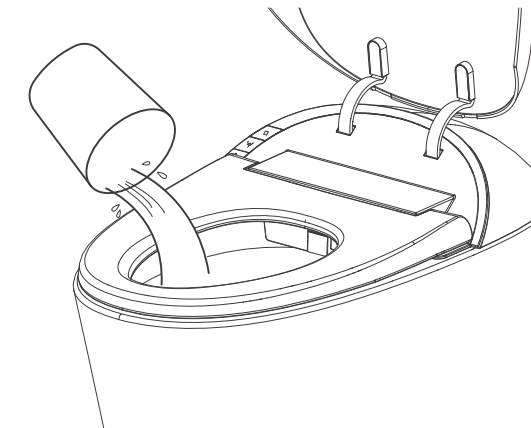

2. Flushing during water outage

Flush the toilet with external water (pour approx. 2 Gallons water into the bowl). Beware of overflow.



● Label Illustration

Illustration	Explain
	Seat sensor
	Foot sensor

NOTE: Drawings may not exactly define contour of the product.

Replace activated carbon

1. Open two rubber plugs, loosen two screws, and pick up two screws and gaskets.

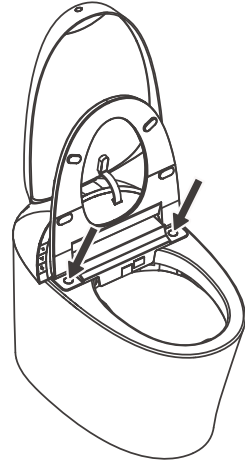

2. Pull out the activated carbon box directly, replace the used activated carbon with new one. Then insert the box into original place.

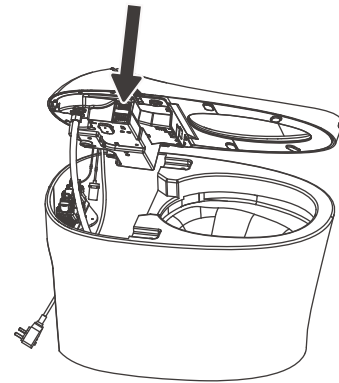

3. Assemble the cover into the ceramic body, lock the screws and cover the rubber plug.

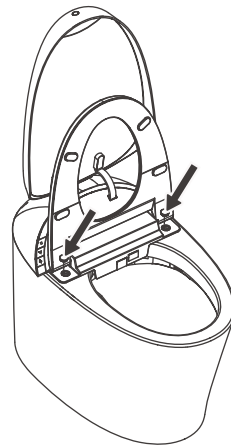

Drain the water in the pipeline when not in use for a long time

1. Pull out the power plug to cut off the power.
2. Close the inlet angle valve, unscrew the hose from the angle valve, drain the water in the pipeline and reinstall it.

For safety, it is recommended to put antifreeze into the accumulated water in the toilet.



TIPS

Before opening the angle valve, the power must be cut off! When using the toilet again, be sure to connect water supply first, then plug in.

NOTE: Drawings may not exactly define contour of the product.

• Safety Precautions

Before installation, please read this manual carefully and install it in strict accordance with the instructions. After reading, please put this manual in a prominent position. Keep the place properly. In order to avoid injury and property damage to users and others, please strictly observe the safety warnings and precautions.

SIGN	MEANING
Warning	It means that if the regulations in this warning are not observed and misoperation is made, serious injury or death may be caused.
Danger	It means that if the regulations in this warning are not observed and misoperation is made, serious injury or death may be caused.

The following signs are used to indicate important safety precautions when using the product.

SIGN	MEANING
	This figure indicates that it is not feasible and [prohibited].
	This figure shows the content that must be enforced.

WARNING

Do not install and use this product in damp places. This product must be reliably grounded, and the reliable connection of AC socket ground wire to the ground should be ensured. The grounding wire should use a tripod socket. If you are not sure whether it has been reliably grounded, please ask a qualified electrician or maintenance personnel to check and confirm. Please ensure that the wiring of the power socket conforms to the national standard (zero on the left and fire on the right) and cannot be reversed.

This product must be connected to a special standard socket and wiring with a 120V/60Hz load current of at least 10A, and the socket must be equipped with earth fault circuit breaker or earth leakage protector or similar high sensitive and fast leakage switch (rated sensitive current below 10mA).











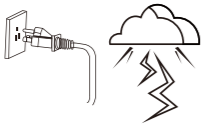

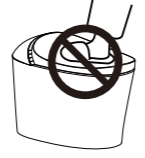

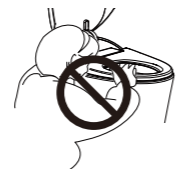
It is forbidden to use the power extension cord or loose and unstable power socket, otherwise it may cause fire or electric shock.

Do not touch the product that has fallen into water or soaked in water, and immediately unplug the power plug.

The lit cigarettes and other combustibles cannot be put into the toilet cover, otherwise it may cause fire. It is forbidden to disassemble, repair or modify the product by yourself, otherwise it may cause fire or electric shock.

If the power cord is damaged, in order to avoid danger, it must be replaced by professionals from the manufacturer, its maintenance department or similar departments.

NOTE: Specialized tools may be necessary to install DeerValley Smart Toilet, plumbing not included.

⚠ WARNING	
<p>Please pull out the power plug when it thunders.</p> 	<p>Do not use water other than tap water, otherwise it may cause skin inflammation and other problems.</p> 
<p>If the product function is abnormal or fails, please stop using it immediately and cut off the power supply, and contact the service provider in time.</p> 	<p>Do not stand on the ceramic toilet, and do not hit the ceramic with gravity to prevent damage and water leakage.</p> 
<p>When used by people (including children) with physical, cognitive and intellectual disabilities or lack of experience and common sense, it is necessary to use this product under supervision, patients with heart disease should use it carefully. Do not let children play with this product.</p> 	<p>Do not put fingers or other objects into or block the drying air outlet, otherwise it may cause scald, electric shock or burn.</p> 
<p>If it is not used for a long time, the power supply and water supply must be cut off.</p> 	<p>It is forbidden to use other electrical appliances on the same socket.</p> 
<p>It is forbidden to disassemble, repair or modify the product by yourself, otherwise it may cause fire or electric shock.</p> 	<p>When the product is powered on, it is not allowed to put the product sideways or upside down, otherwise it may cause fire or burn.</p> 
<p>Banana water, gasoline, liquid medicine, detergent, insecticide, toilet cleaner and hard brush are prohibited to clean this product.</p> 	<p>The socket shall be installed in a place that is not easy to be soaked by water. It is recommended to use waterproof socket.</p> 
<p>Do not pour water or detergent on the machine body or power plug, otherwise it may cause fire or electric shock.</p> 	<p>The new hose assembly and other attached or designated parts attached with the appliance shall be used for installation. The old hose assembly cannot be reused, otherwise, it may cause water leakage, fire or electric shock.</p> 
<p>This product is an electrical product. It is forbidden to put it in a place that is easy to be soaked by water. Do not pour urine or other liquids onto the body.</p> 	<p>When the product is moved indoors from a cold or wet place, it should be stored for 2 hours to fully volatilize the condensed water in the machine, and then it can be started for use, to avoid short circuit of products.</p> 

NOTE: Drawings may not exactly define contour of the product.

• Daily Maintenance



Maintenance of body

- 1. Cut off the power supply**
Please cut off the power supply before maintenance.
- 2. Wipe with soft cloth**
Please wipe the dirty parts with a soft damp cloth and then let it dry.
- 3. Safety self-inspection**
Please reconnect the power supply after cleaning.

Nozzle maintenance

- 1. Nozzle extends**
Press and hold the "Stop" button and "Rear wash" button on the remote control for 3 seconds at the same time to enter the manual cleaning procedure.
- 2. Nozzle cleaning**
Please wipe with a soft cloth or soft brush.
- 3. Cleaning is completed**
Press the "Stop" button to exit the manual cleaning mode and the nozzle will retract automatically.

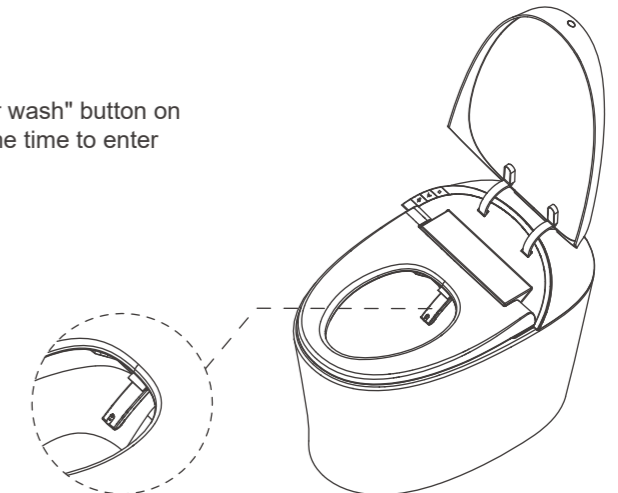

Filter screen cleaning

1. Close the valve.
2. Rotate counterclockwise to remove the filter screen.
3. Rinse and clean the filter screen.

NOTE: Drawings may not exactly define contour of the product.

● Automatic Function

1. AUTOMATIC OPEN/CLOSE LID FUNCTION (Suitable for models equipped with this feature)

When opting for an electronic toilet with the automatic open/close lid function, experience the ease of hands-free operation for both the toilet lid and seat.

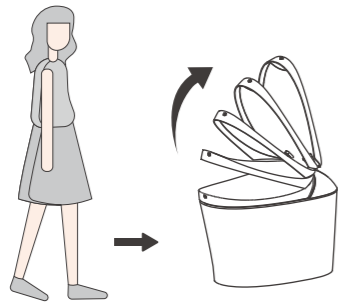

1. Auto Open

As soon as the toilet senses the proximity of a person, the lid will automatically open following the detection of human movement.

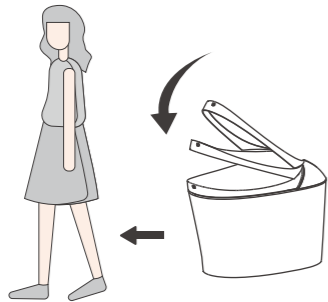

2. Auto Close

If the toilet remains unused for more than 60 seconds after the last use, the toilet lid and seat will close automatically.

2. Automatic flush after leaving the seat

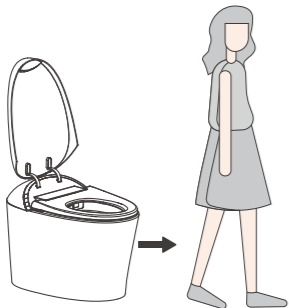

When the system detects a user remaining on the seat for 30 seconds or more in the automatic flush mode, it initiates the automatic flush function within 5±1 seconds after the user leaves the seat.

3. Foot Sensor Operation (Applicable for models with this function)

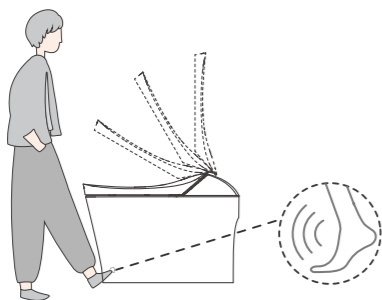

1. Closed Lid & Seat: Use the foot sensor to open the lid and seat, and after use, close both with the foot sensor, triggering bowl flushing.
2. Open Lid Only: Activate the foot sensor to open the seat, and after use, close both seat and lid with the foot sensor, initiating bowl flushing.
3. Open Lid & Seat: Close both lid and seat using the foot sensor, while also activating bowl flushing.

NOTE: Drawings may not exactly define contour of the product.

! WARNING

<p>Do not place the product where it may fall or be pulled into the bathtub or sink. </p>	<p>Do not connect the water pipe with the outlet pipe of the water heater. The water inlet temperature is 41°F -104°F. If it exceeds the specified range, it may cause internal heating. The component does not work properly. </p>
<p>Do not put this product in water or other liquids. </p>	<p>When using this product, do not lean back on the toilet cover to avoid damaging the product. </p>
<p>Do not touch the product that has fallen into water or soaked in water, and immediately unplug the power plug. </p>	<p>Please do not flush newspaper, paper urinal pads, women's sanitary napkins and other easily clogged items into the toilet. </p>
<p>It is forbidden to embed cementitious materials (cement mortar) into the base of the ceramic toilet, otherwise the ceramic toilet may be cracked due to expansion. </p>	<p>Do not use the product in an environment below 0°C. If the room temperature is lower than 32°F, the water in the water supply line of the product must be drained. Prevent the water way from freezing and cracking, causing water leakage or fire during later use. </p>
<p>Do not exert strong force or impact, do not stand on the seat ring, toilet cover or this product, and do not place heavy objects. </p>	<p>To prevent damage caused by freezing, please take measures to keep warm and increase the temperature of the toilet. </p>
<p>Do not let the sun shine directly on the product to avoid discoloration and affect the reception effect of the remote control. </p>	<p>When installing, disassembling, repairing and maintaining the product, you must unplug the power plug and close the water supply valve. </p>
	<p>The seat ring and toilet lid of this product would lower slowly. Do not press hard to avoid damaging it. </p>

NOTE: Drawings may not exactly define contour of the product.

• Technical Specifications

Rated voltage		120V
Rated frequency		60Hz
Rated power		1240W
Pressure of Water supply		20.31psi (minimum necessary water pressure) - 116.03psi (static pressure); Flow of water supply at least 7.93gpm
Ambient temperature		32°F-104°F
Temperature of water supply		41°F-104°F
Toilet Flushing	Flushing type	Jet Siphon
	Rough in	12in
Cleansing	Water heating type	Instant heating
	Water heating power	1300W
	Warm water temperature	Off, 86°F-102.2°F(6 levels)
	Safety device	Temperature fuse, water temperature sensor, grounding protection, over-temp protection
Dryer	Min air volume	≥ 0.2m³/ min
	Air heating power	250W
	Dryer temperature	Off, 86°F-122°F
	Safety device	Temperature controller, temperature fuse, leakage protection plug.
Heating seat	Seat heating power	40W
	Seat temperature	86°F-100.4°F
	Safety device	Temperature sensor, temperature fuse, temperature controller, grounding protection
Product size		28.1*17*19.8in
Water proof rate		IPX4

Note:



Rated Power: To determine the rated power of the product, it undergoes testing under specific conditions. These conditions include an ambient temperature of 73.4°F, static water inlet pressure of 116.03psi+/-2.9psi, and water inlet temperature of 41°F. During the testing, the water pressure, seat temperature, and water temperature are sequentially set to the highest level. The product then immediately initiates the rear wash function and continues to operate steadily for the duration of an average cleaning cycle. The power consumption during this cycle is measured to obtain the rated power value.

NOTE: Drawings may not exactly define contour of the product.

4. Remote control match code

Before powering on, long press the Front wash button " " on the remote control. When the indicator lights flash, power on the machine to start remote control pairing. After hearing two beep sound, the pairing is successful. Press the Stop button on the remote control, or wait for 10 seconds, and the 5 indicator lights will turn off, indicating the completion of the pairing process.

5. Turn on/off lid auto open function



Simultaneously, press and hold the Night Light button " " and Open/Close S&C " " on the remote control for 5 seconds. The buzzer will beep, indicating the activation or deactivation of the automatic flip function.

6. Turn on/off pre-wetting inner ring

Long press Rear wash button " " to turn on/off pre-wetting function.

7. Turn on/off automatic flush after user leaving seat

DV-1S0160-V3: Long press the Flush button " " and Rear wash button " " on the remote control to toggle the automatic flush function on or off after the user leaves the seat.

DV-1S0160: Long press the Flush button " " and Rear wash button " " on the remote control to toggle the automatic flush function on or off after the user leaves the seat.

NOTE: Drawings may not exactly define contour of the product.

Control function setting

1. Nozzle manual cleaning function

- To enter the manual cleaning procedure, press and hold the "Stop" button and the "Rear wash" button on the remote control simultaneously for 3 seconds.
- Manual cleaning procedure: The nozzle will extend out, and self-clean water will start flowing. Allow the nozzle to extend to its longest position. Once the nozzle reaches the longest position, detach the nozzle from the cleaning module. Use a soft cloth to carefully wipe the nozzle.
- When there are 10 seconds remaining, you will hear ten beeps as an indication. After the cleaning procedure is finished, the nozzle will retract automatically.

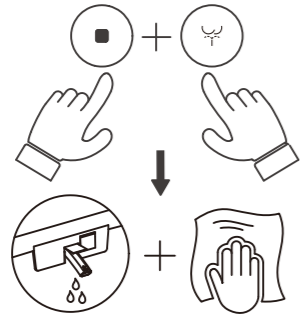

Press and hold the "Stop" and "Rear Wash" buttons on the remote control 3 seconds.

Enter the manual cleaning mode to clean the nozzles.

- During the manual cleaning process, press the "Stop" button on the remote control or knob to exit the manual cleaning mode and the nozzle will retract;
- After the manual cleaning is completed or stopped halfway, the nozzle retracts automatically.

2. Nozzle automatic cleaning function

- Press the "Stop" button and "Front Wash" button on the remote control for 3 seconds at the same time to enter the nozzle automatic cleaning mode.
- The nozzle will extend and retract automatically during the cleaning process, completing a total of 2 minutes cleaning duration. Press the Stop button to cease the function midway.

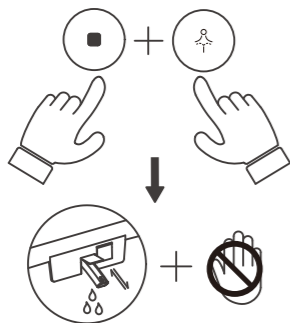

Press and hold the "Stop" and "Front Wash" buttons on the remote control 3 seconds.

The automatic cleaning mode is now active. Manual cleaning is strictly prohibited, and exercise caution to avoid pinching hands during operation.

- During the automatic cleaning, if a user is seated, the system will exit the automatic cleaning mode. The nozzle will cease water flow and retract automatically.

3. Mute function

- Press the "Stop" and "Drying" keys on the remote control for 3 seconds at the same time to enter the mute mode.
- Press the "Stop" and "Drying" keys on the remote control for 3 seconds again to exit the mute mode.
- The buzzer function is off in mute mode.

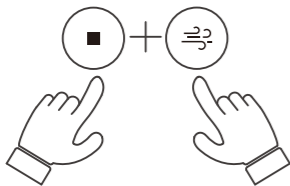

NOTE: Drawings may not exactly define contour of the product.

• Pre-installation

Parts diagram

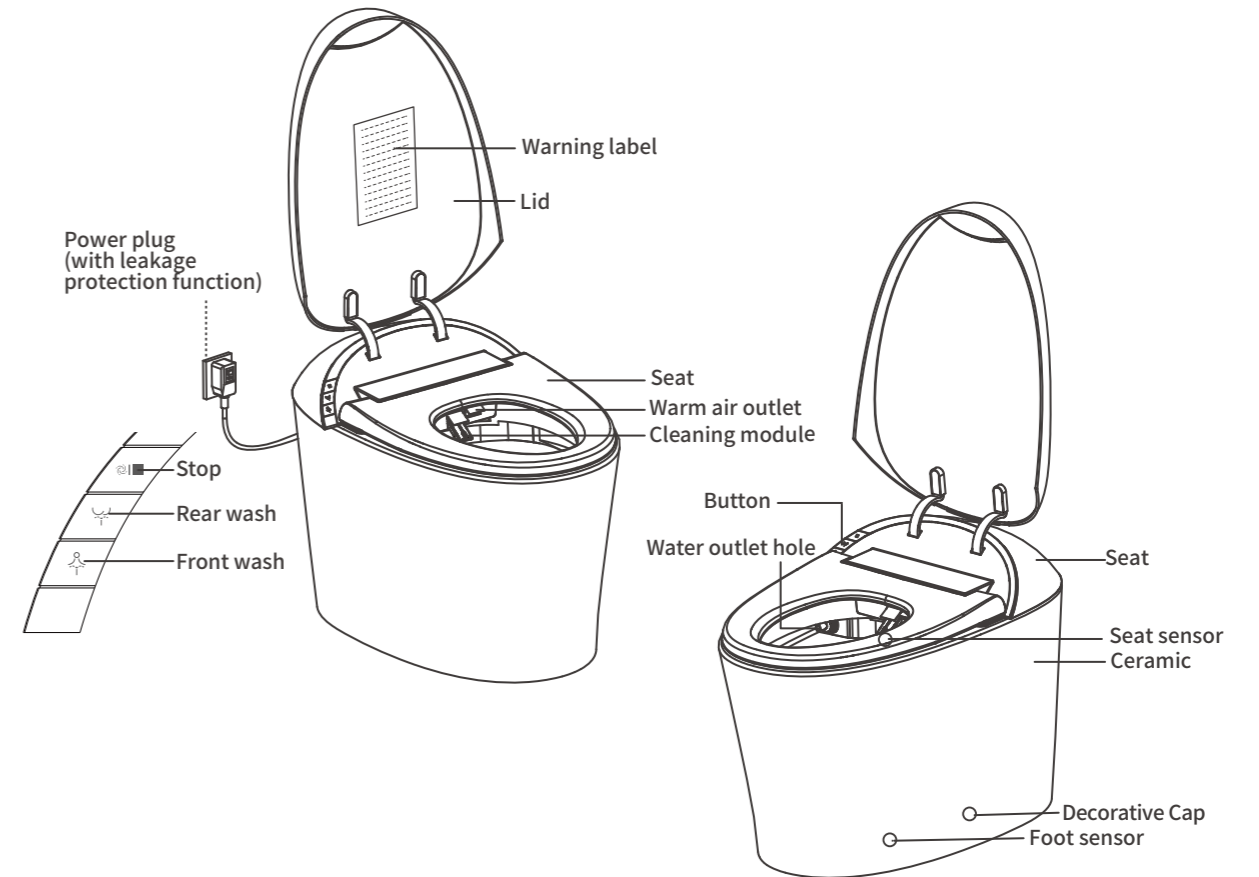

Tools required

Please prepare the following required tools before installation.

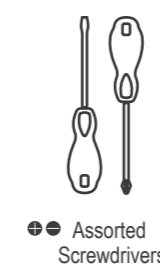
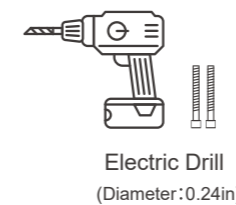

NOTE: Drawings may not exactly define contour of the product.

Hardware Included

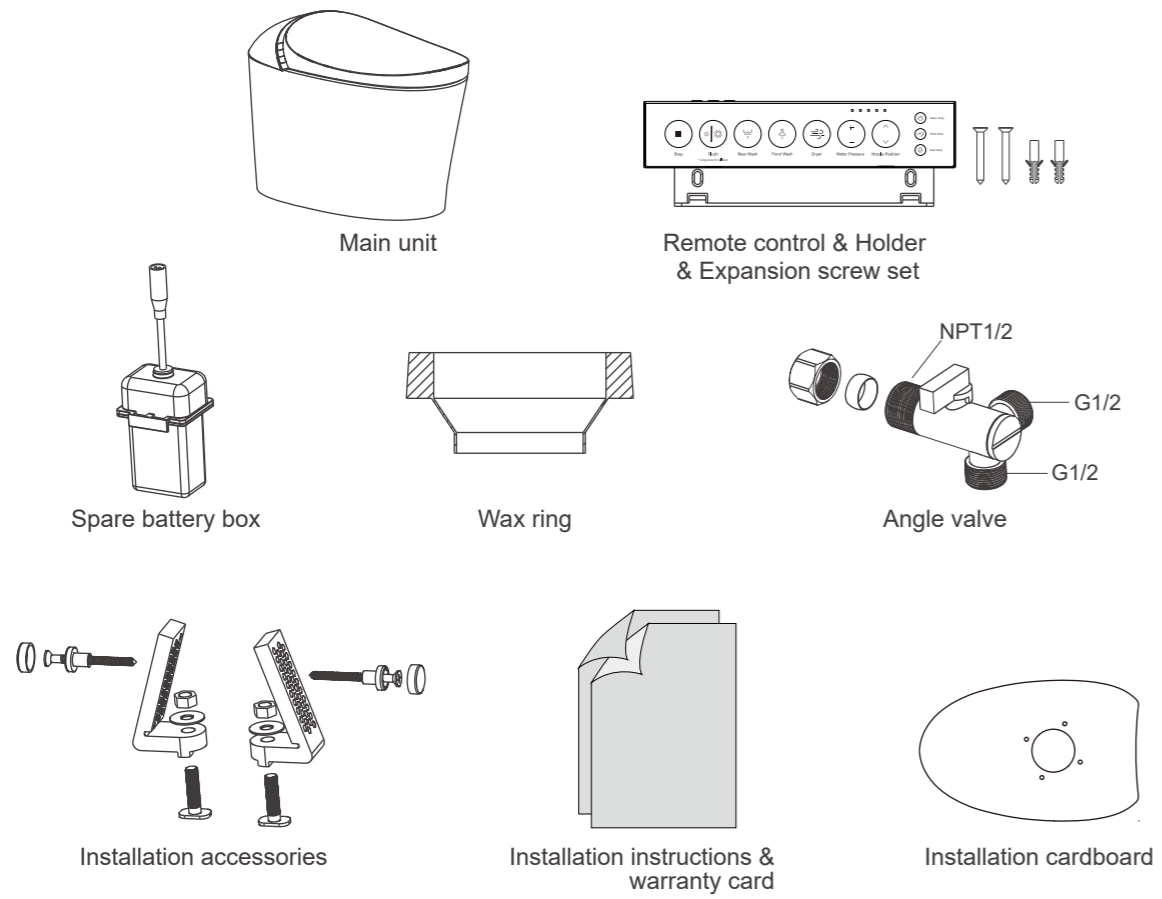

Part	Quantity	Part	Quantity
Main unit	1	Spare battery box	1
Remote control	1		
Wax ring	1		
Angle valve	1		
Installation accessories	1 Set		
User manual	1		
Installation cardboard	1		

Picture for reference only

NOTE: Drawings may not exactly define contour of the product.



Water temperature adjustment

When cleaning, the water temperature is adjustable with 6 gears. When in off gear, the water flows in ambient temperature and the indicator light is off.



Air temperature adjustment

When drying, the air temperature is adjustable with 6 gears. When in off gear, it blows in ambient temperature and the indicator light is off.



Seat temperature adjustment

The seat temperature is adjustable with 6 gears. Please do not cover the seat sensor in case of sensing failure. The seat temperature will switch to 1st gear after long time sitting in case of low-temperature burns.

Top view of remote control

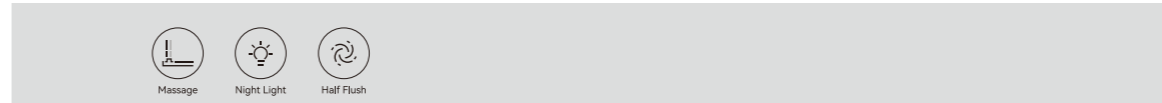

Pulse message

When performing rear washing and front washing functions, press the message button on the remote control to enter the pulse message mode.



Night light

Press this button to turn on/off the night light.



Half Flush

Press this button to perform the half flush function.

NOTE: Drawings may not exactly define contour of the product.

Applicable for model: DV-1S0160

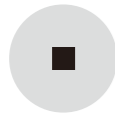
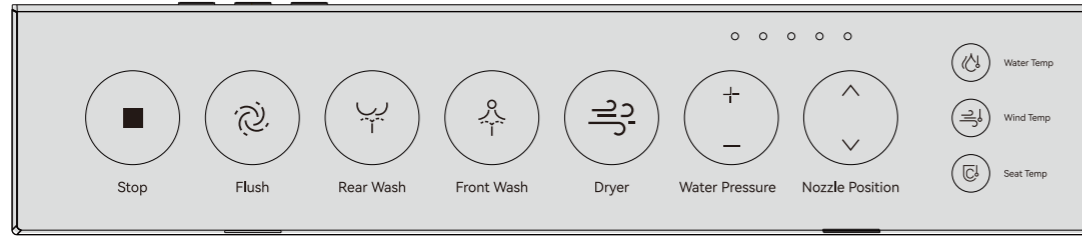

Stop

Short press stop button to cease on-going functions halfway. Long press stop button to enter or exit ECO mode. Under this mode, the seat temperature will be lowered to 1st gear automatically. Once human is seated, it will exit ECO Mode. When human is off-seat, the ECO mode will resume.



Full flushing

Short press the flush button to perform the flushing function.



Rear wash/Oscillating massage

Press this button to start the rear wash function. Press this button again to perform oscillating massage. If you press the Stop key halfway, you can stop it immediately. Note: Under the oscillating massage procedure, the nozzle will extend and retract repeatedly to achieve the massage effect.



Front wash/Oscillating massage

Press this button to start the front wash function. Press this button again to perform oscillating massage. If you press the Stop key halfway, you can stop it immediately. Note: Under the oscillating massage procedure, the nozzle will extend and retract repeatedly to achieve the massage effect.



Dryer

Press this button to initiate warm air drying. Adjust the air temperature as desired. If the "Stop" button is pressed during the drying process, the warm air drying function will cease immediately.



Water pressure adjustment

When cleaning, press this button to adjust water pressure in 5 different gears. Press + key once to raise one level, press - key once to decrease one level. The indicator light will display accordingly.



Nozzle position adjustment

The nozzle position can be adjusted with 5 gears. Press the nozzle adjustment ^ key to extend the nozzle forward, press the nozzle adjustment v key to retract nozzle backwards.

NOTE: Drawings may not exactly define contour of the product.

• Installation

Technical drawing (unit: in)

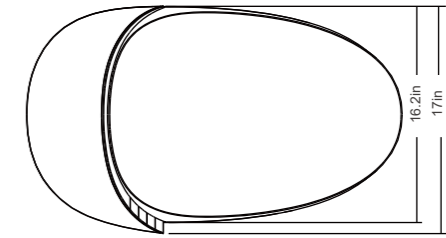
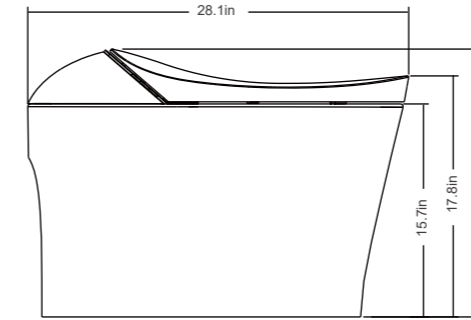

1. Install the offered angle valve

Mark the center line of the drain outlet on the ground, and install the water inlet angle valve at a suitable position on the wall according to the size of the toilet. After installing the angle valve, open the valve to discharge the sewage.

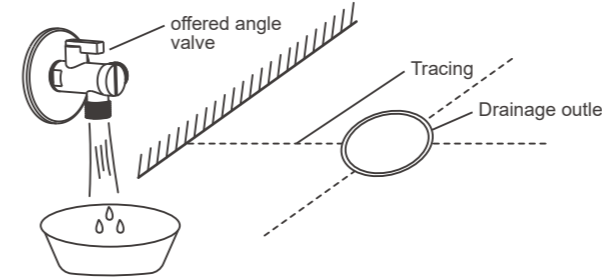

2. Mark the drain with a cross line

Cardboard installation

- Align the cardboard with the center line of the drain;
- Draw contour lines from cardboard.

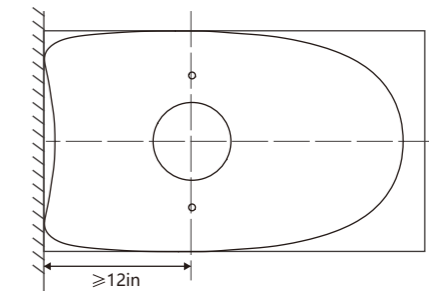

3. Install the flange plate

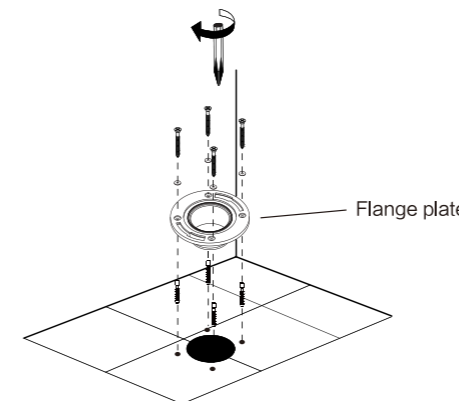

4. Position correctly the two fixing bolts of the flange

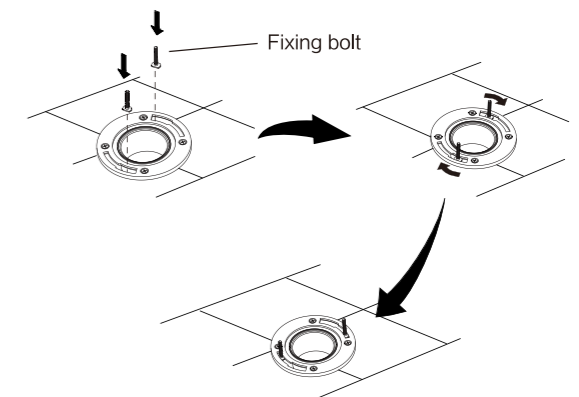

NOTE: Drawings may not exactly define contour of the product.

5. Assemble the mounting bracket with bolts and then install them to the pre-installed flange plate on the ground and lock tight with nuts.

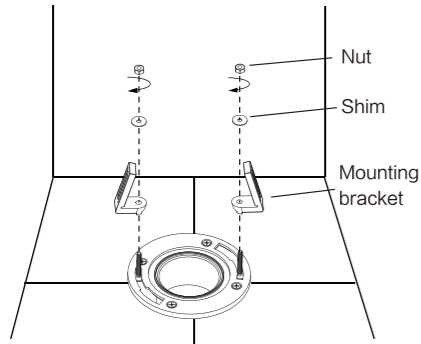

7. Install waxing ring into drain outlet; Install ceramic toilet on corresponding position according to contour line.

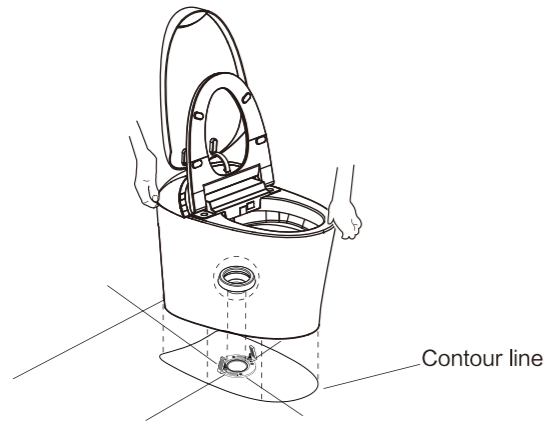

9. Connect hose and angle valve

As illustrated below, connect and securely tighten the inlet hose to the angle valve.

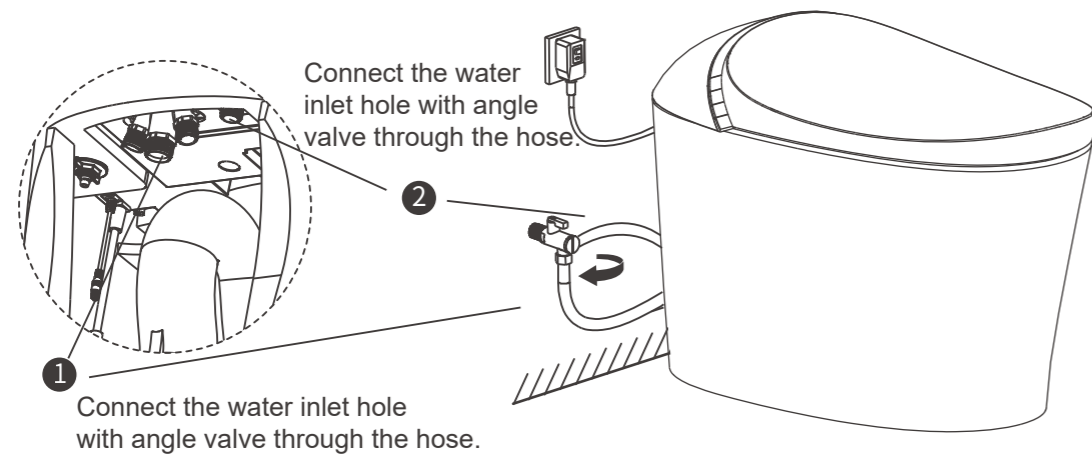

NOTE: Drawings may not exactly define contour of the product.

6. Insert the wax ring under the toilet.

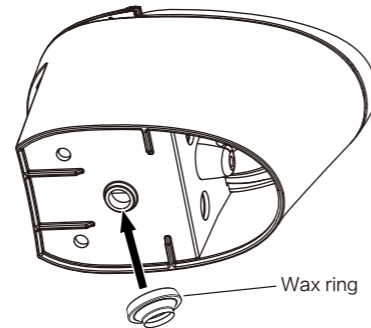

8. Put the screw through the fixing sleeve and then install it through the holes (on both sides of the toilet ceramic) to the mounting bracket on the ground, and lock tight with a tool, put the decorative cap on the fixing sleeve.

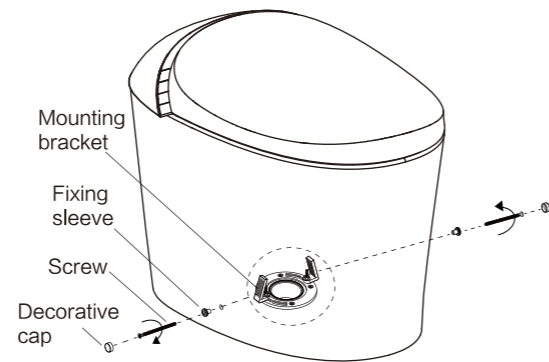

Water temperature adjustment

When cleaning, the water temperature is adjustable with 6 gears. When in off gear, the water flows in ambient temperature and the indicator light is off.



Air temperature adjustment

When drying, the air temperature is adjustable with 6 gears. When in off gear, it blows in ambient temperature and the indicator light is off.



Seat temperature adjustment

The seat temperature is adjustable with 6 gears. Please do not cover the seat sensor in case of sensing failure. The seat temperature will switch to 1st gear after long time sitting in case of low-temperature burns.

Top view of remote control



Pulse massage

When performing rear washing and front washing functions, press the massage button on the remote control to enter the pulse massage mode.



Night light

Press this button to toggle the night light through three modes: auto-sensing mode, on mode, and off mode.

Note: Under auto mode, the night light will automatically turn on when the lid is opened. It will also turn off automatically when the lid is closed.



Open/close S&C

1. When the lid and seat are closed, press this button to open lid.
2. When the lid is open and seat is closed, press this button to open seat.
3. When the lid and seat are open, press this button to close seat and lid.

NOTE: Drawings may not exactly define contour of the product.

Remote Control Instructions

Applicable for model: DV-1S0160-V3

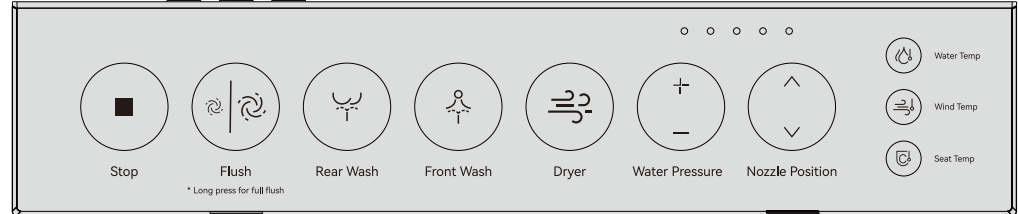

- Stop**
Short press stop button to cease on-going functions halfway. Long press stop button to enter or exit ECO mode. Under this mode, the seat temperature will be lowered to 1st gear automatically. Once human is seated, it will exit ECO Mode. When human is off-seat, the ECO mode will resume.
- Full flushing**
Short press this button to perform half flush function. Long press this button to perform full flush function.
- Rear wash/Oscillating massage**
Press this button to start the rear wash function. Press this button again to perform oscillating massage. If you press the Stop key halfway, you can stop it immediately. Note: Under the oscillating massage procedure, the nozzle will extend and retract repeatedly to achieve the massage effect.
- Front wash/Oscillating massage**
Press this button to start the front wash function. Press this button again to perform oscillating massage. If you press the Stop key halfway, you can stop it immediately. Note: Under the oscillating massage procedure, the nozzle will extend and retract repeatedly to achieve the massage effect.
- Dryer**
Press this button to initiate warm air drying. Adjust the air temperature as desired. If the "Stop" button is pressed during the drying process, the warm air drying function will cease immediately.
- Water pressure adjustment**
When cleaning, press this button to adjust water pressure in 5 different gears. Press + key once to raise one level, press - key once to decrease one level. The indicator light will display accordingly.
- Nozzle position adjustment**
The nozzle position can be adjusted with 5 gears. Press the nozzle adjustment ^ key to extend the nozzle forward, press the nozzle adjustment v key to retract nozzle backwards.

NOTE: Drawings may not exactly define contour of the product.

10. Install the battery box

1. Put battery (9V, not included) in the battery box.
2. Connect the line

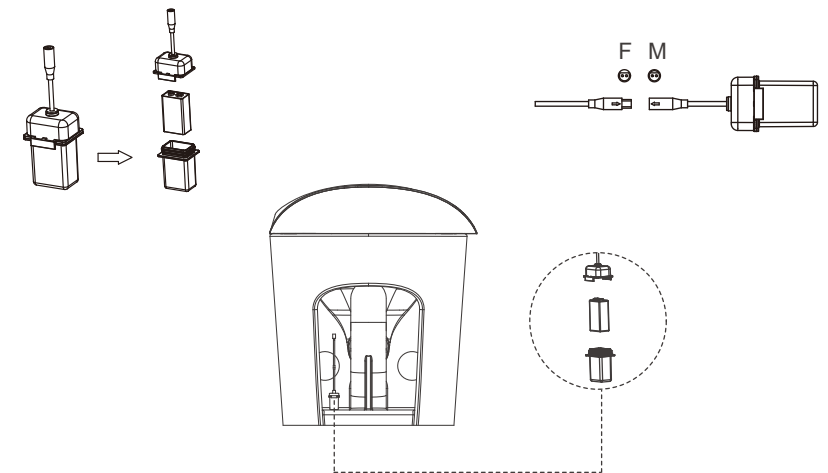

Battery replacement

1. Remove the battery box from the back of the toilet and pull out the battery box connector.
2. Open the battery box, remove the old battery and replace it with a new one.
3. Plug in the battery box connector and the toilet cable and put them back on the back of the toilet.

11. Open the angle valve

Check the tightness of the threaded connection to make sure there is no water leakage. Turn the angle valve counterclockwise and adjust the opening to the maximum.

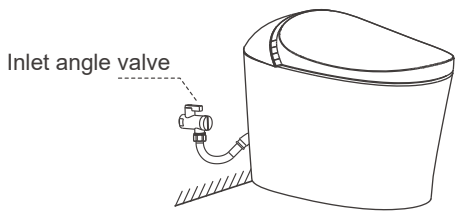

REMINDER

When opening the angle valve for the first time, it may be a bit tight.

12. Power on

Plug the leakage protection plug into the power socket, press the reset switch, and the plug indicator light will be on, indicating that it is powered on.

REMINDER

*Press the leakage test key before use, the reset switch pops up, indicating leakage protection. The protection function is normal.

*Press the TEST button (then RESET button) every month to assure proper operation.

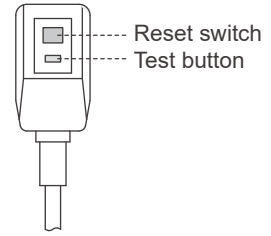

*It is applicable to the model with leakage protection plug. The leakage protection plug is subject to the actual object.

13. Safety self-inspection

Upon power-up, the machine will automatically open the lid and seat, extend and retract the cleaning nozzle. Subsequently, the lid and seat will close, accompanied by a two-tone beep, signifying the completion of the self-inspection process.

NOTE: Drawings may not exactly define contour of the product.

• Remote Control Installation and Battery Replacement

Install remote control

1. Install the remote control rack

(1) Stick the remote control rack horizontally to the pre-installation area on the wall, and mark the position of two installation holes on the wall with a marker. Use a drill bit with a diameter of 6mm to drill holes at the marked positions on the wall, with a depth of 1.4in.

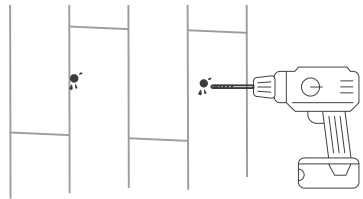

(2) Install the expansion pipe into the wall hole, attach the hanger to the wall, align the hole on the hanger with the expansion pipe, and place the screw to lock it.

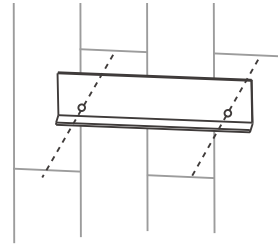

2. Install the remote control hanger (only for the hanger with fixed plate and foam rubber pad)

(1) Clean and dry the pre-installed area of the remote control rack on the wall.

(2) Tear off the double-sided adhesive sticker on the back of the hanger and stick it horizontally to the wall.

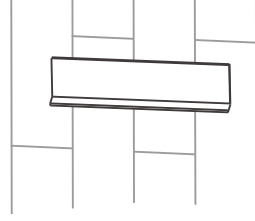
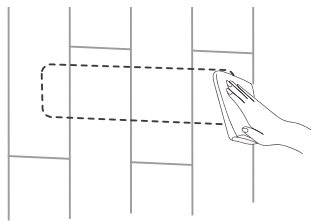

3. Install the battery into the remote control, and place it on the rack.

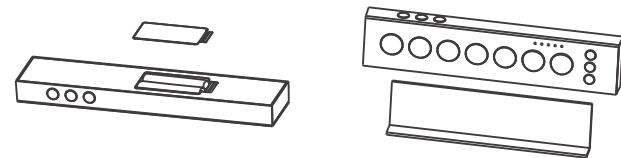

4. Use and replacement of remote control battery

- The remote control uses 2 AAA alkaline batteries.
- When the battery is low, the red light on the remote control flashes or lights up, prompting the user to replace the battery.

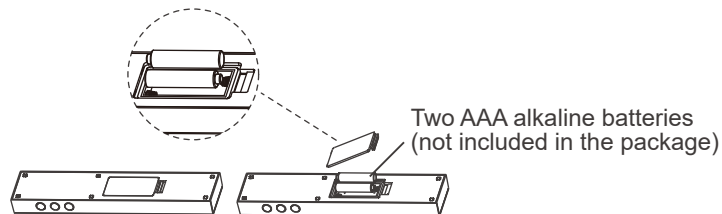

Attention

- (1) The positive and negative electrodes of the battery must match those on the remote control.
- (2) New and old batteries cannot be mixed.
- (3) Please use alkaline batteries.

NOTE: Drawings may not exactly define contour of the product.

• Side Button Operation

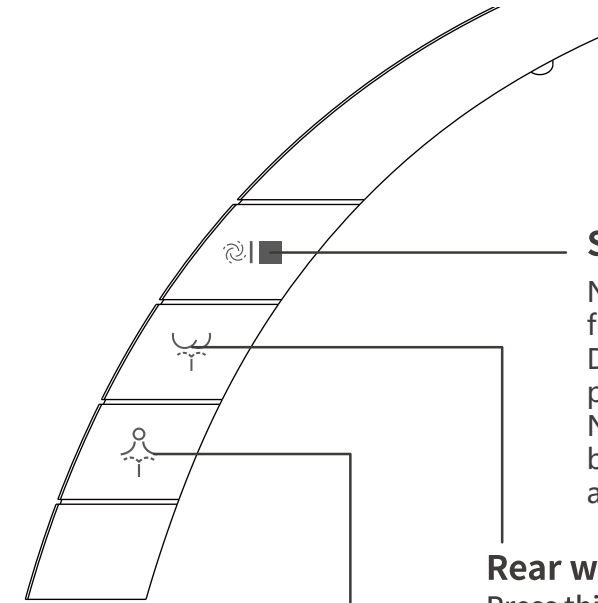

Stop

Non-functional Status: Press this button to activate the flushing function.
During Operation: While the machine is running functions, press this button to halt the ongoing procedure.
Note: Under non-seated situation, long press this button to enter standby mode, in which mode the night light automatically off. Press any button to quite standby mode.

Rear wash

Press this button to perform rear wash. Press twice to perform oscillating massage.

Front wash

Press this button to perform front wash. Press twice to perform oscillating massage.

Note for Ultraviolet Sterilization Function (Applicable for models with this function):

After human leave the seat and lid is closed, the UV sterilization light will automatically turn on. The sterilization process will continue for approximately 5 minutes. The sterilization function will automatically off once the lid is open.

NOTE: Drawings may not exactly define contour of the product.