

Read Operation Instructions Carefully Before Use

LITTLE TIKES 3 IN 1 RIDE ON

- Used as stroller
- Used as riding car



Please read the installation instructions carefully before installation











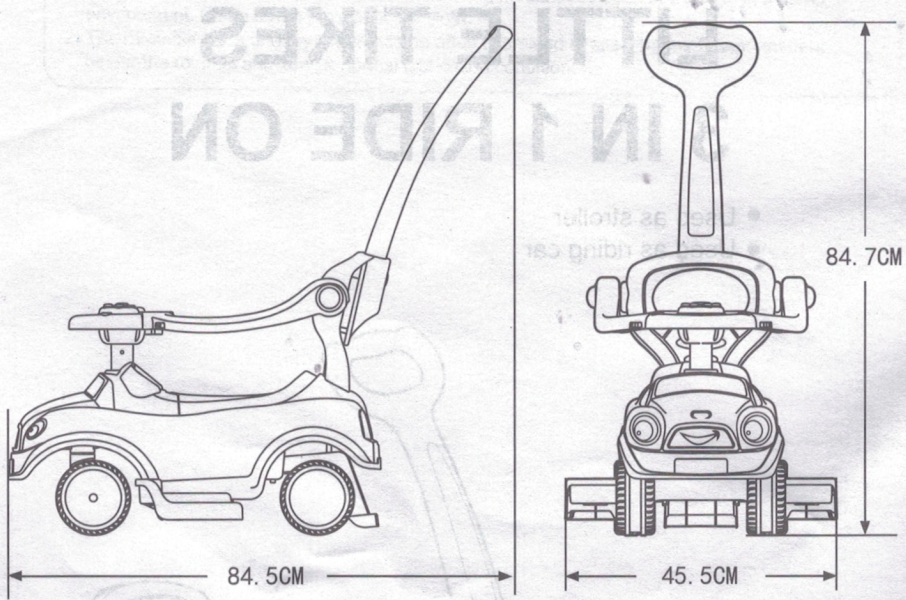

www.littletikes.com

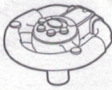

® & © The Little Tikes Company, U.S. & other countries.
Used under license by Dongguan Chi Lok Bo Toys
Company Limited.

Dimension of car

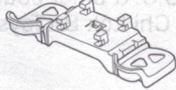

<p>1.Semi-assembled main body</p> 	<p>5.Armrest guardrail</p> 	<p>9.Steering wheel screw-cap</p> 
<p>2.Steering wheel</p> 	<p>6.Backrest</p> 	<p>10.Steering wheel fixed tube</p> 
<p>3.Easy wheel x2</p> 	<p>7.Push knob</p> 	
<p>4.Pedal</p> 	<p>8.Steering wheel screw</p> 	

Beginning of assembly

1. Assembly of car body (please see the assembly order)

- 1 Insert the steering wheel fixed tube from the assigned location of car bottom into car front end according to the buckle hole direction.
- 2 Insert the steering wheel into the steering wheel fixed tube, and fix it with the screw and screw cap.
- 3 Insert the easy wheel into the assigned location of car bottom.
- 4 Insert the backrest into the assigned location of the car rear end.
- 5 Insert the armrest guardrail into the assigned location of both ends of the backrest, spin forward and buckle the steering wheel.
- 6 Insert the push knob into the assigned location of the backrest upper end.

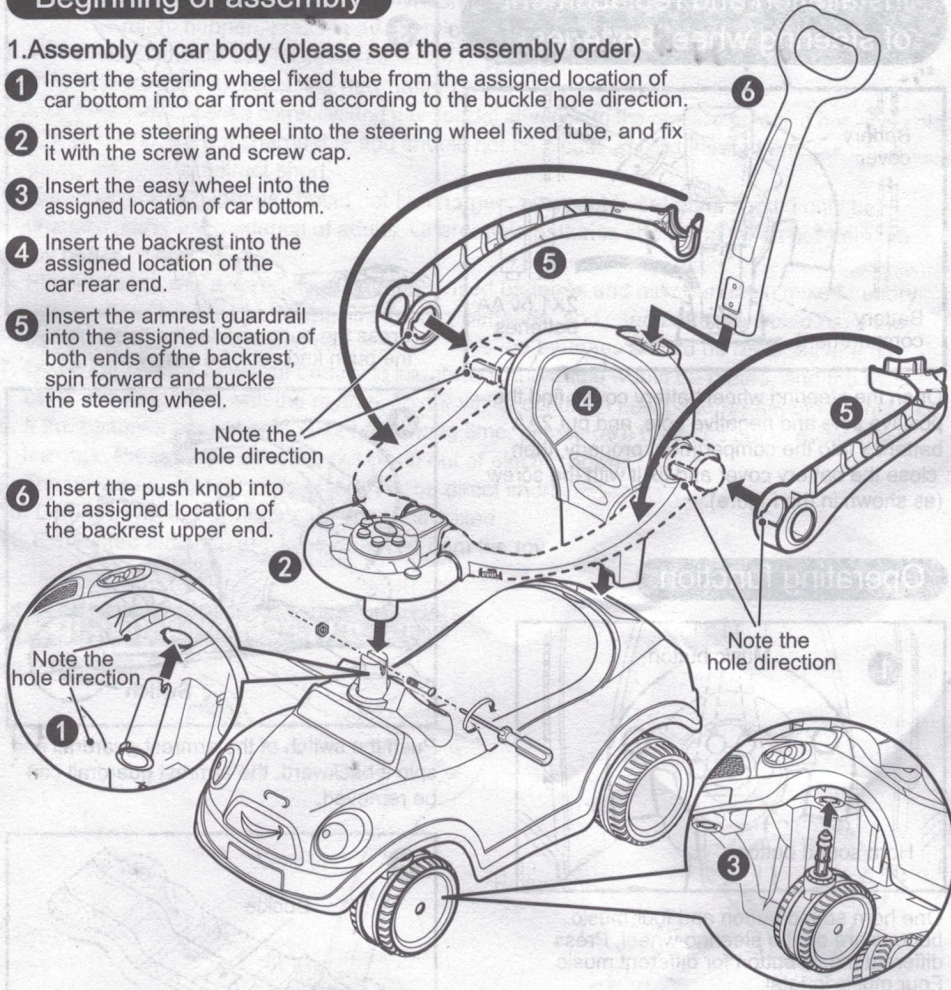

2. Installation of pedal

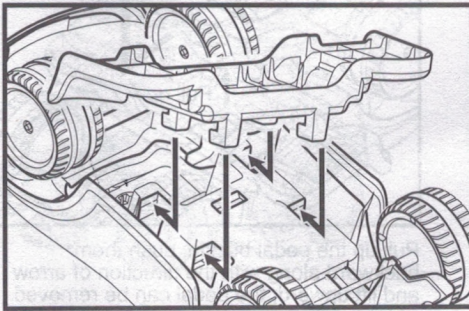

Insert the pedal buckles into the assigned location of the car bottom and push them forward along with the direction of arrow until fasten them.

Installation and replacement of steering wheel batteries

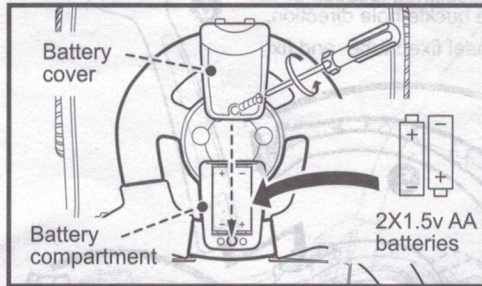

Open the steering wheel battery cover, find the positive pole and negative pole, and put 2AA batteries into the compartment properly, then close the battery cover and fix it with the screw (as shown in the Figure).

Operating function

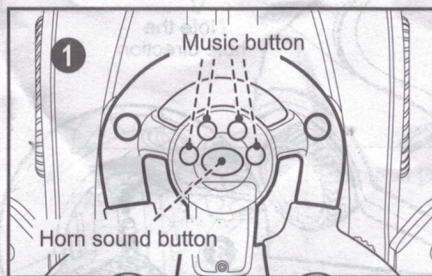

One horn sound button and four music buttons are on the steering wheel. Press different music button for different music. Four music in total.

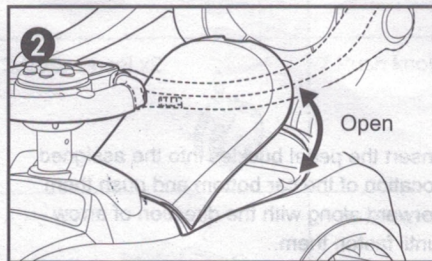

Open the seat and put the goods in it.

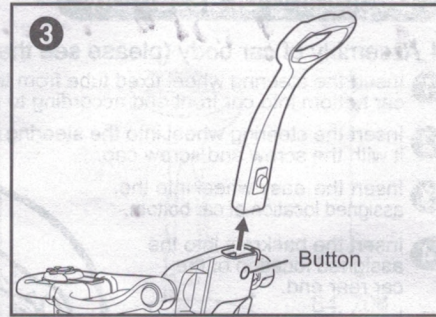

Press the button under the push knob, the push knob can be removed.

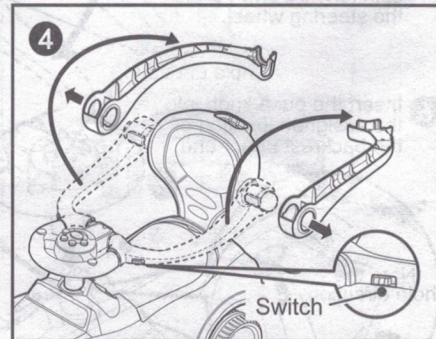

Push the switch of the armrest guardrail and spin it backward, the armrest guardrail can be removed.

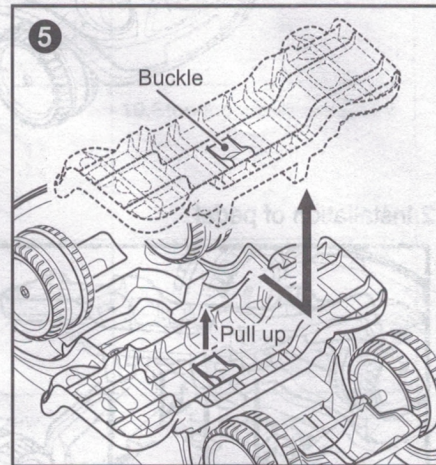

Pull up the pedal buckle, push them backward along with the direction of arrow and lift upward, the pedal can be removed.

Caution! When installing new batteries, dangers such as damage, heat, liquid leakage etc. might happen, please pay attention to the following cautions:

1. This product should use NO.5 AA batteries (2 pieces).
2. Please ask adults for replacing new battery.
3. Install the new batteries correctly; and pay special attention to the positive pole and negative pole.
4. The batteries are not chargeable and should not be disassembled, heated and put into fire, which are to avoid direct short.
5. Non-chargeable batteries should not be charged, chargeable batteries should only be charged under the guidance of adults. Chargeable batteries should be taken out from the toy before charging.
6. Please do not mix different type batteries, used batteries and new batteries; mixed battery use would affect the operational life span of batteries, and used batteries would have the danger of liquid leakage and damage etc. Thus the batteries should be replaced entirely.
7. When the electric power of battery is insufficient, the audio would be muted, and the music could not keep pace with the rhythm. Under which condition new batteries should be installed.
8. If the batteries are not being used for a long time, please take batteries out to avoid liquid leakage. Please take batteries out when out of electric power.
9. The power supply terminals should not be direct short.
10. Different types of batteries are not to be mixed.
11. Exhausted batteries are to be removed from the toy.

Item transformation function

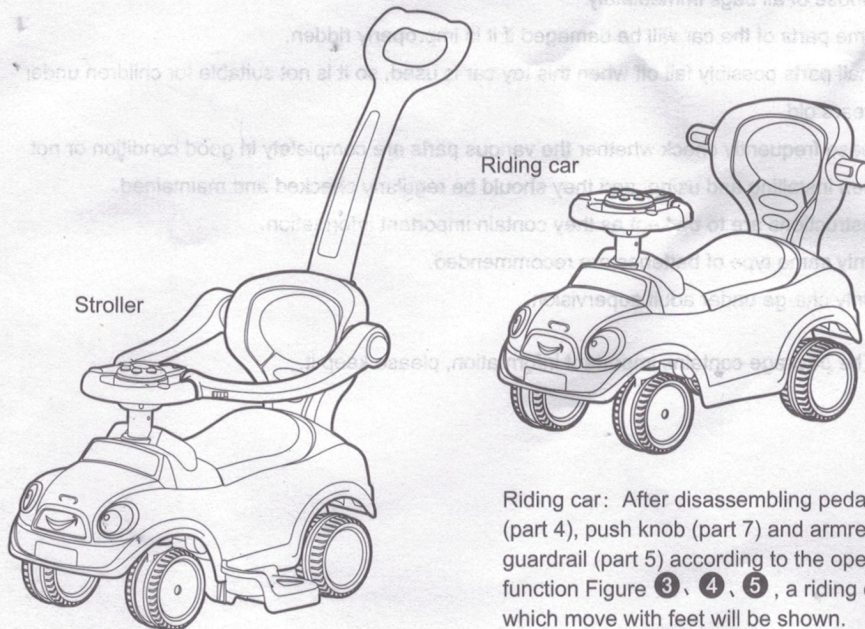

Riding car: After disassembling pedal (part 4), push knob (part 7) and armrest guardrail (part 5) according to the operating function Figure 3、4、5, a riding car which move with feet will be shown.

Troubleshooting Guide

Problem	Check if
Horn or music sounds are not working correctly	The battery is full of power, otherwise the battery needs to be charged or replaced.

Safety operation guide

This operation guide shows you how to ensure children riding the motor with joy and safety.

Please read below safety operation guide carefully before use.

- 1) Children should ride the motor properly with adult's guidance and instructions, otherwise children themselves or others may be hurt.
- 2) Some possible sharp edge, cuspidal points or small parts may be on the toy before assembly, so the toy should be assembled by adult.
- 3) Don't ride the car in such dangerous places as street, road, steep slope and beside swimming pool. Otherwise, it may cause traffic accident or drowning hazard.
- 4) The item is only suitable for children of 2-6 years old. Children must put on shoes and protective equipments before use, such as: helmet, hands pads and knee pads.
- 5) The car maximum load is 23 kg. No overload running.
- 6) To avoid suffocation, keep all bags away from babies and children.
Dispose of all bags immediately.
- 7) Some parts of the car will be damaged if it is improperly ridden.
- 8) Small parts possibly fall off when this toy car is used, so it is not suitable for children under 2 years old.
- 9) Please frequently check whether the various parts are completely in good condition or not when installing and using, and they should be regularly checked and maintained.
- 10) Instructions are to be kept as they contain important information.
- 11) Only same type of batteries are recommended.
- 12) Only charge under adult supervision.

The package contains important information, please keep it.

WARNING:



WARNING

To reduce the risk of injury, adult supervision is required at all times. In the interests of safety, **DO NOT** use this product on public roads, near motor vehicles, uneven ground, swimming pools or where there is water.

Product must only be used by one child at a time.



WARNING

Protective clothing and equipment should always be worn when using this product.



WARNING

Please keep the product and all parts away from children before full assembly has been completed by a responsible adult. Unassembled product contains small parts and potentially harmful sharp edges.



www.fisherprice.com

002-01

Care and Maintenance

- 1) The product contains electronic components and must not be used in water or in a damp environment. Clean it with a piece of dry cloth.
- 2) The rotatable parts of baby car should be often examined to see whether foreign matters hinder the rotation and keep a normal lubrication condition.

K07-SMS-142-002

002-01