

BusyWood  
Model 22  
80x60

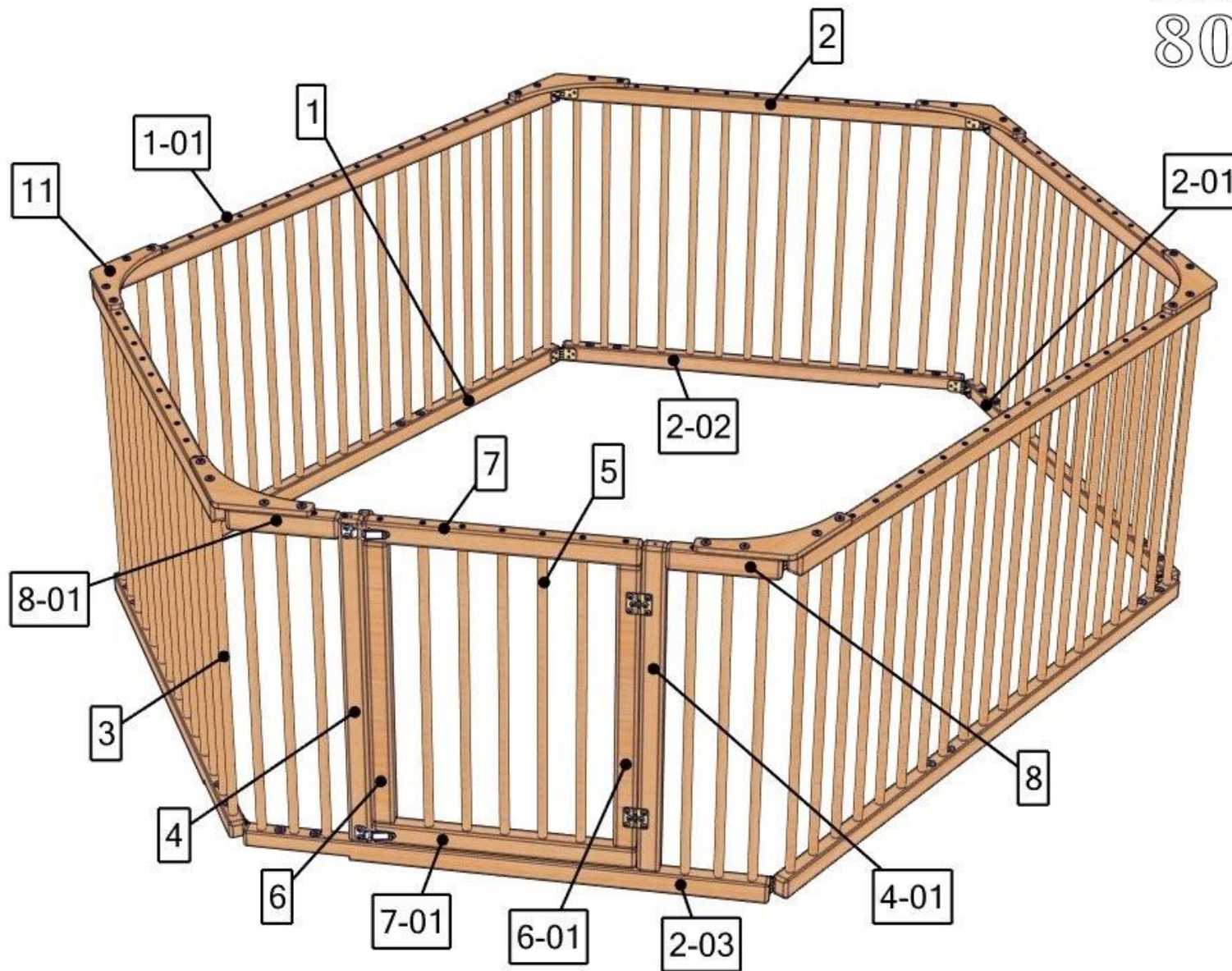

1 and 1-01 longest parts

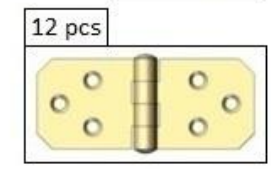
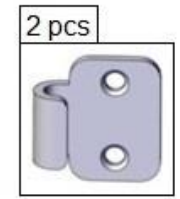
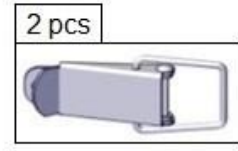
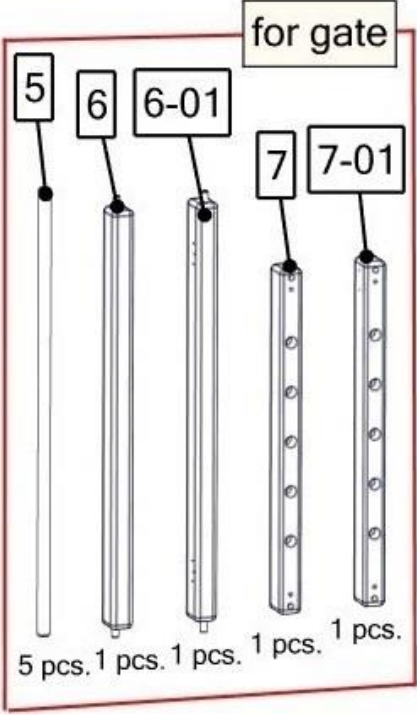
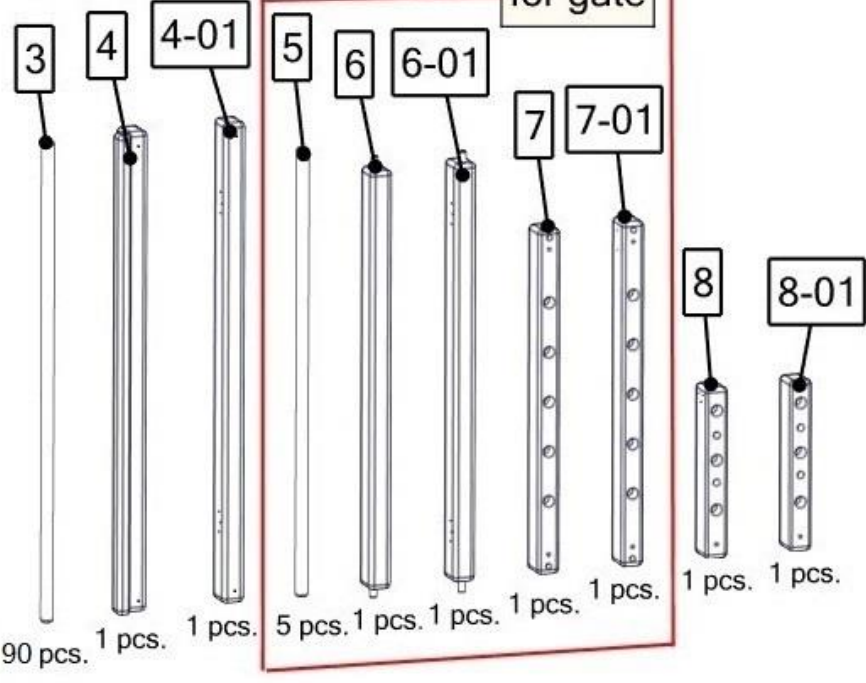
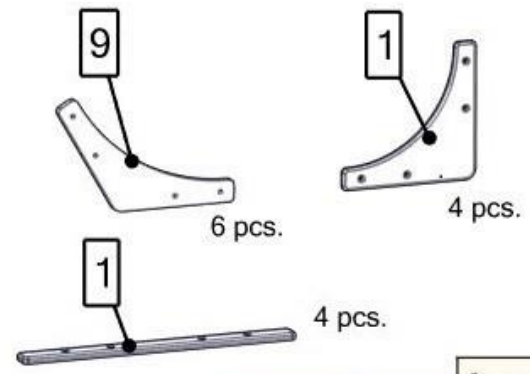
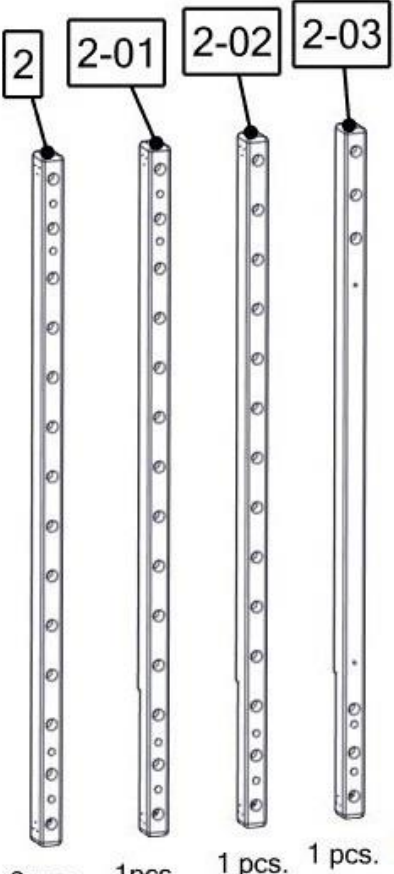
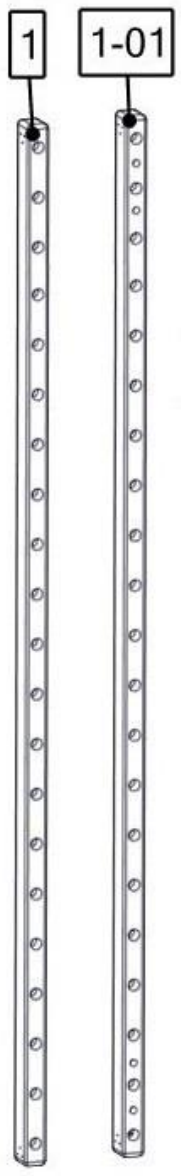
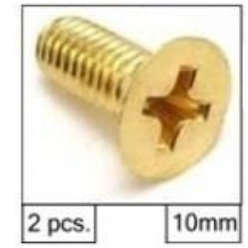
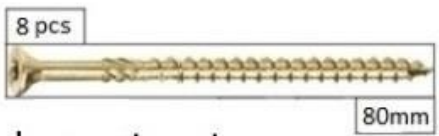

2 pcs. 2 pcs. 3 pcs. 1 pcs. 1 pcs. 1 pcs.

Total wooden parts: 127



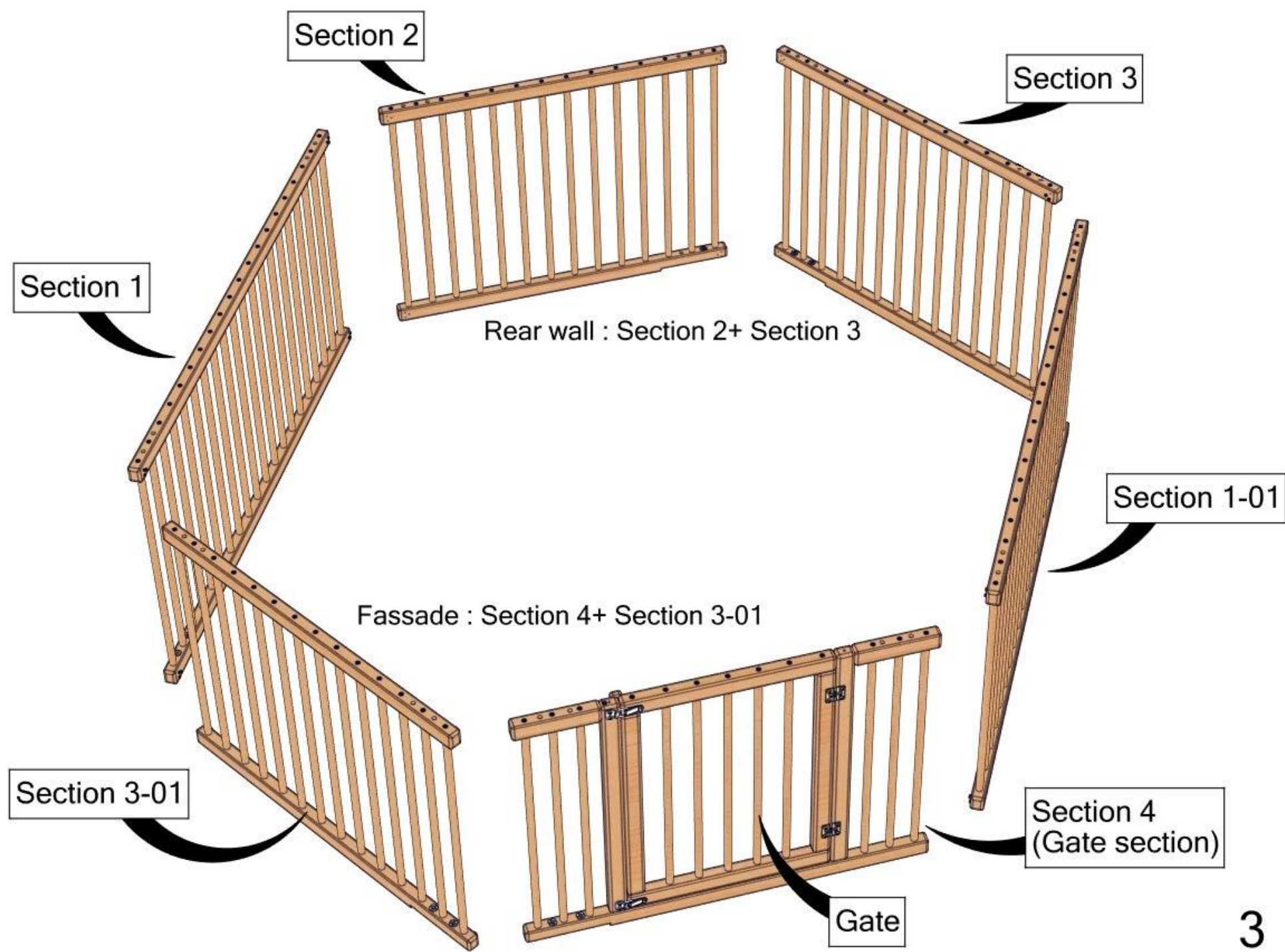

# Assembly of the Section 1 & 1-01

Start with the longest parts 1 and 1-01.

It is necessary to arrange the holes for the hinges on all parts in the same way

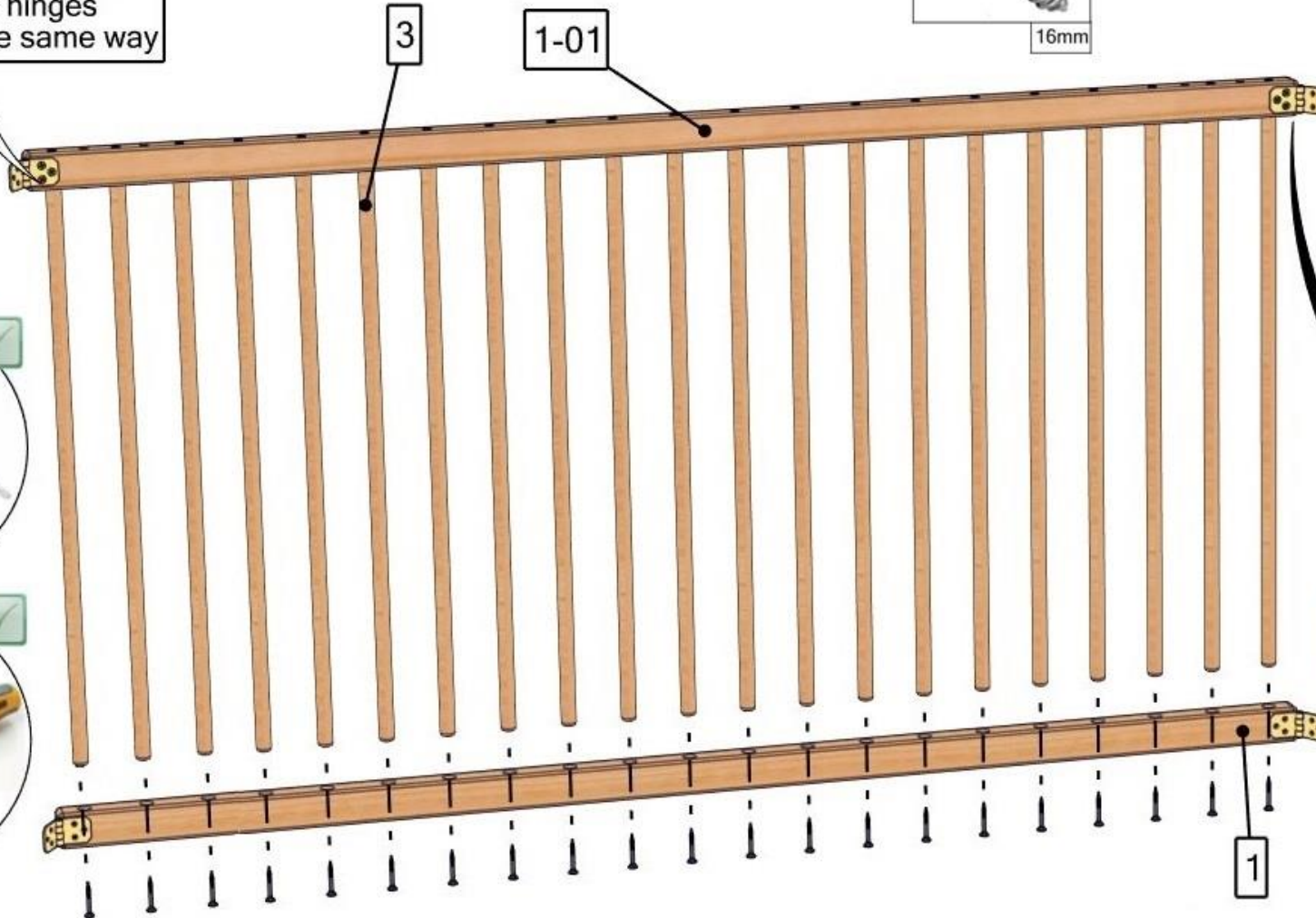
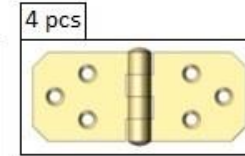
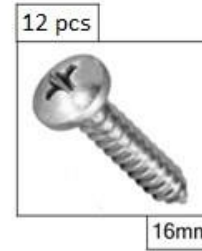

Do not fasten the hinges immediately completely, do it when everything is assembled.



For ease of assembly, assemble all 3 pieces with 1-01, then attach piece 1 by starting assembly at a slight angle



# Section 2 assembly

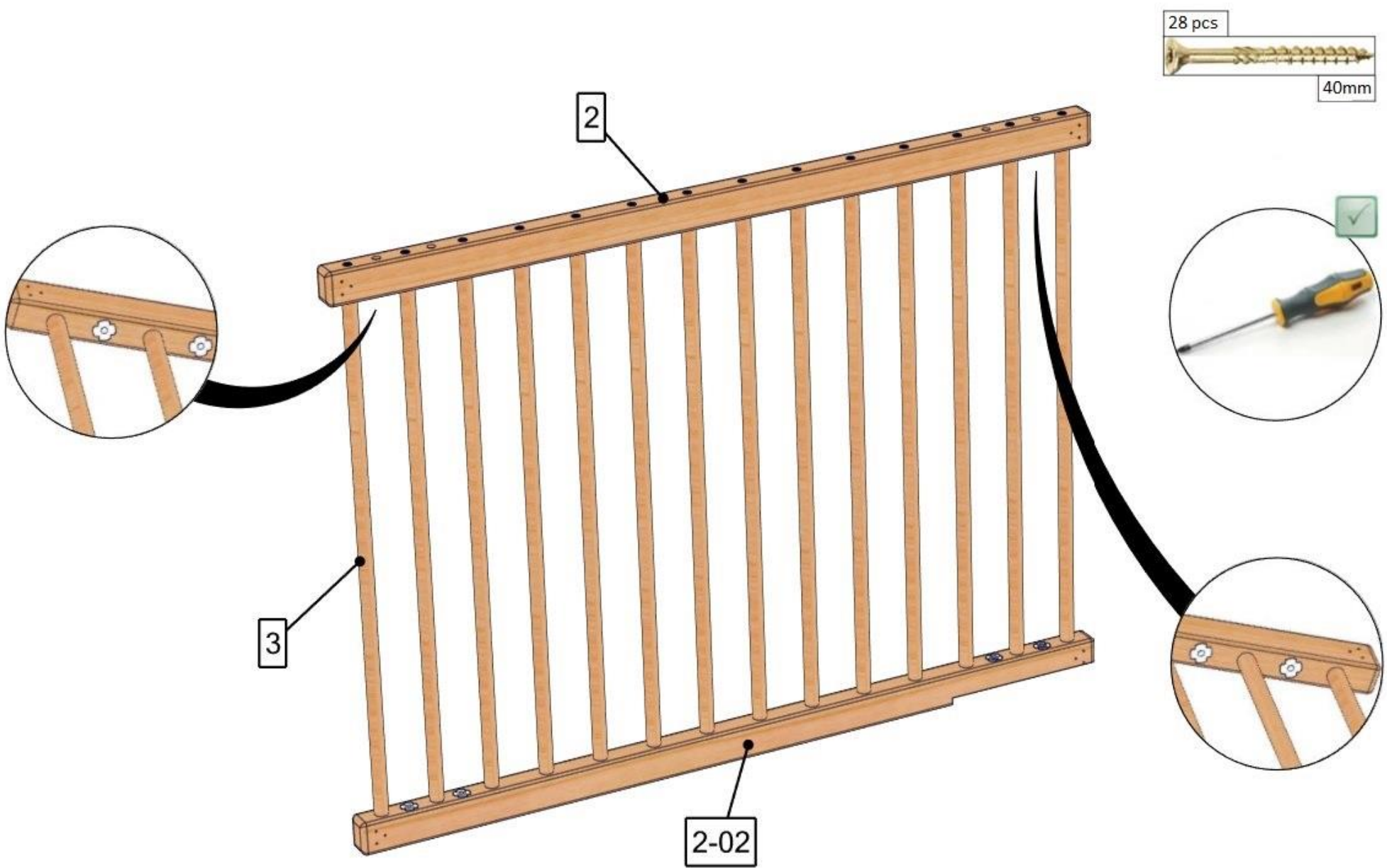

# Section 3 & 3-01 assembly

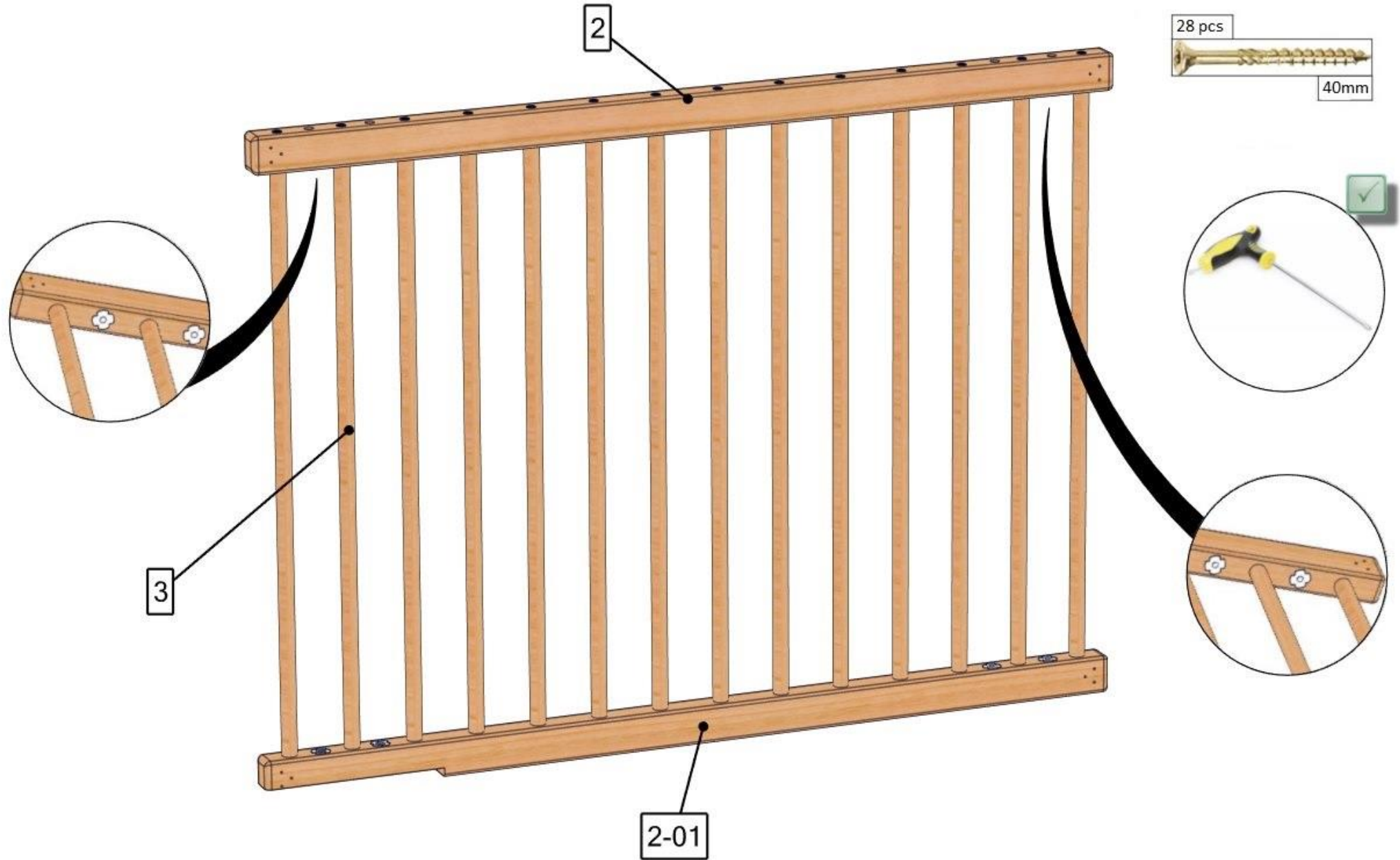

# Section 4 assembly

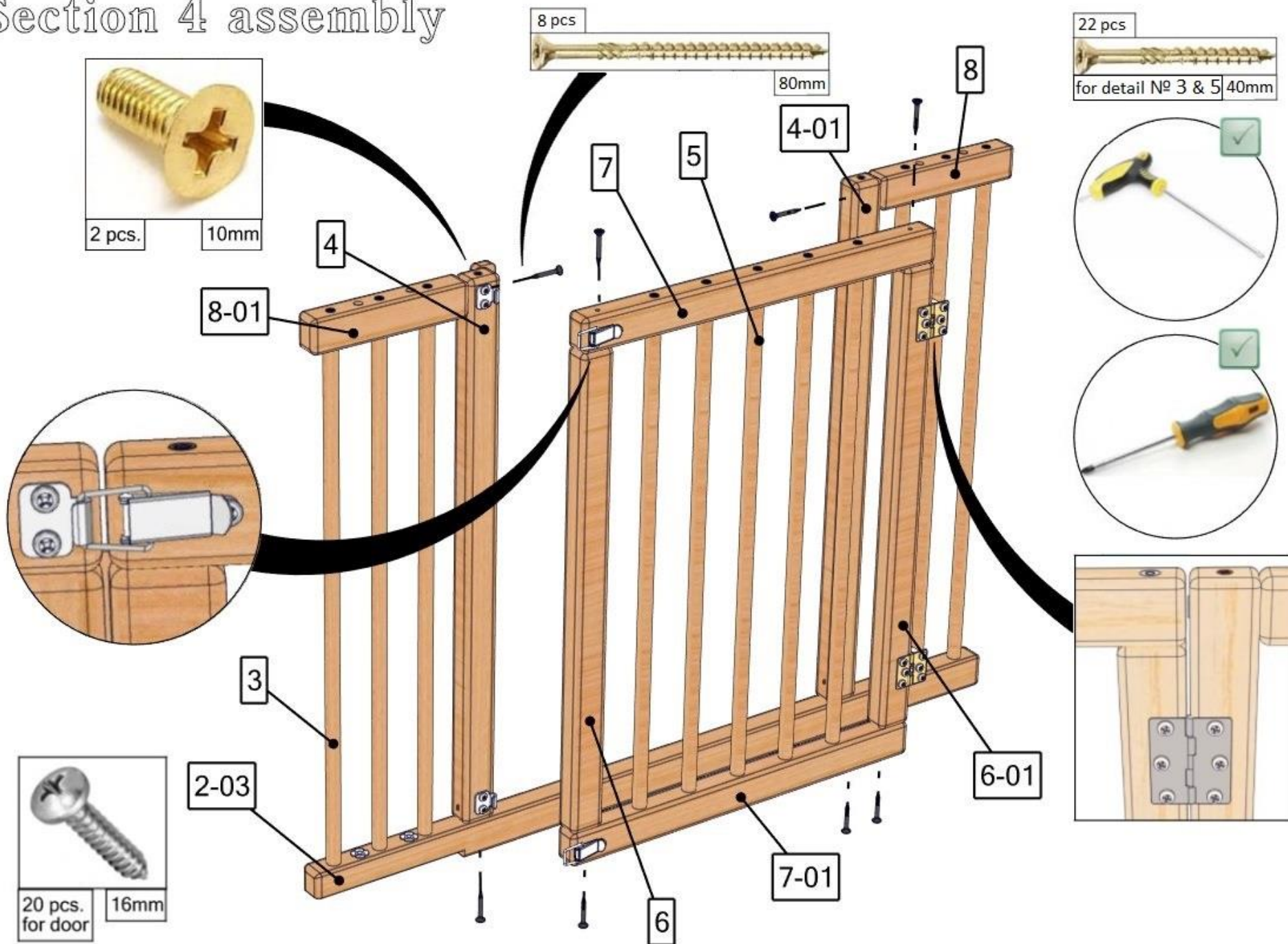



# Facade assembly

Section 3-01

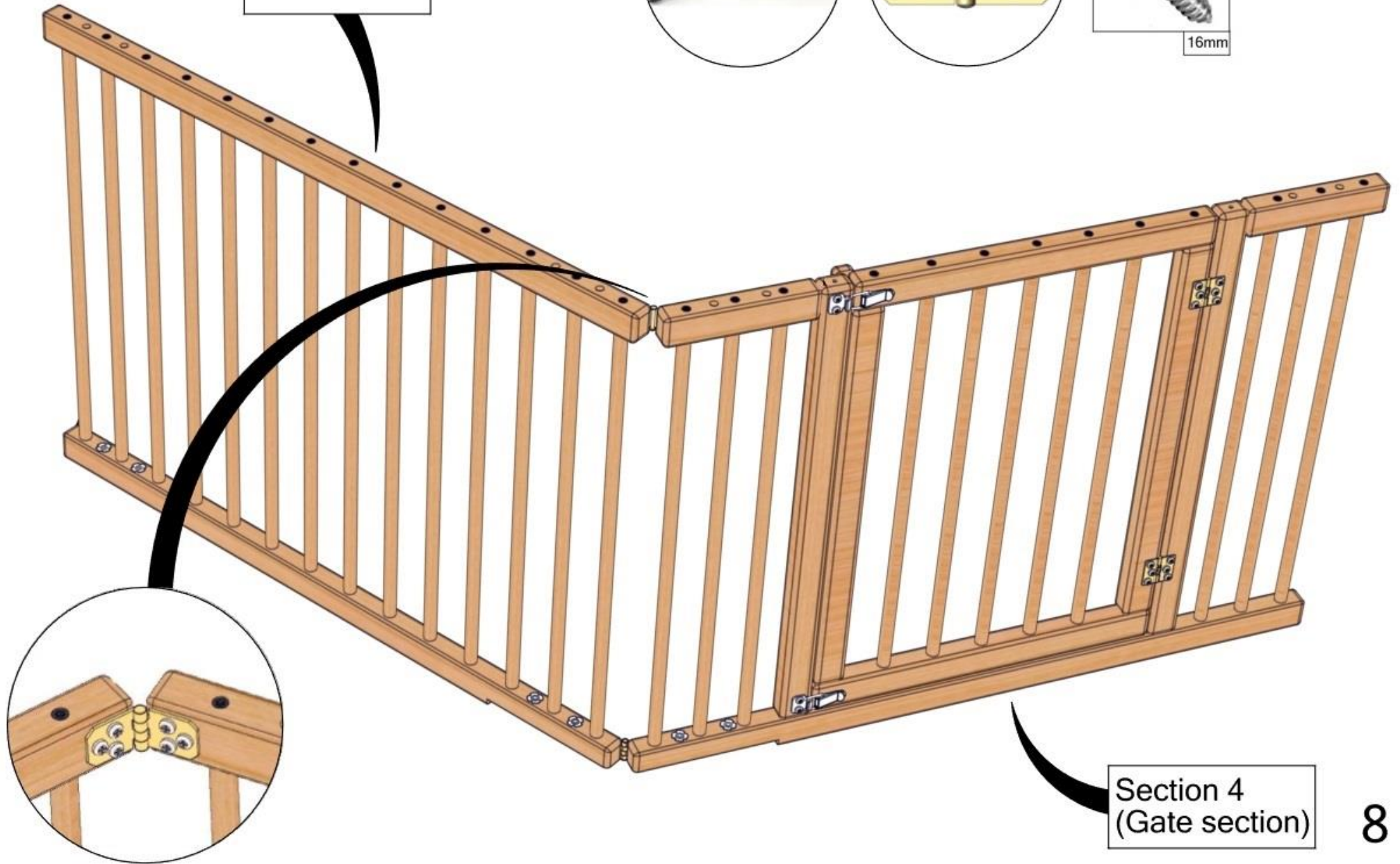
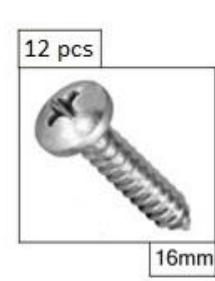
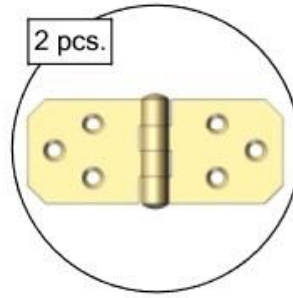

Section 4  
(Gate section)



# Rear wall assembly

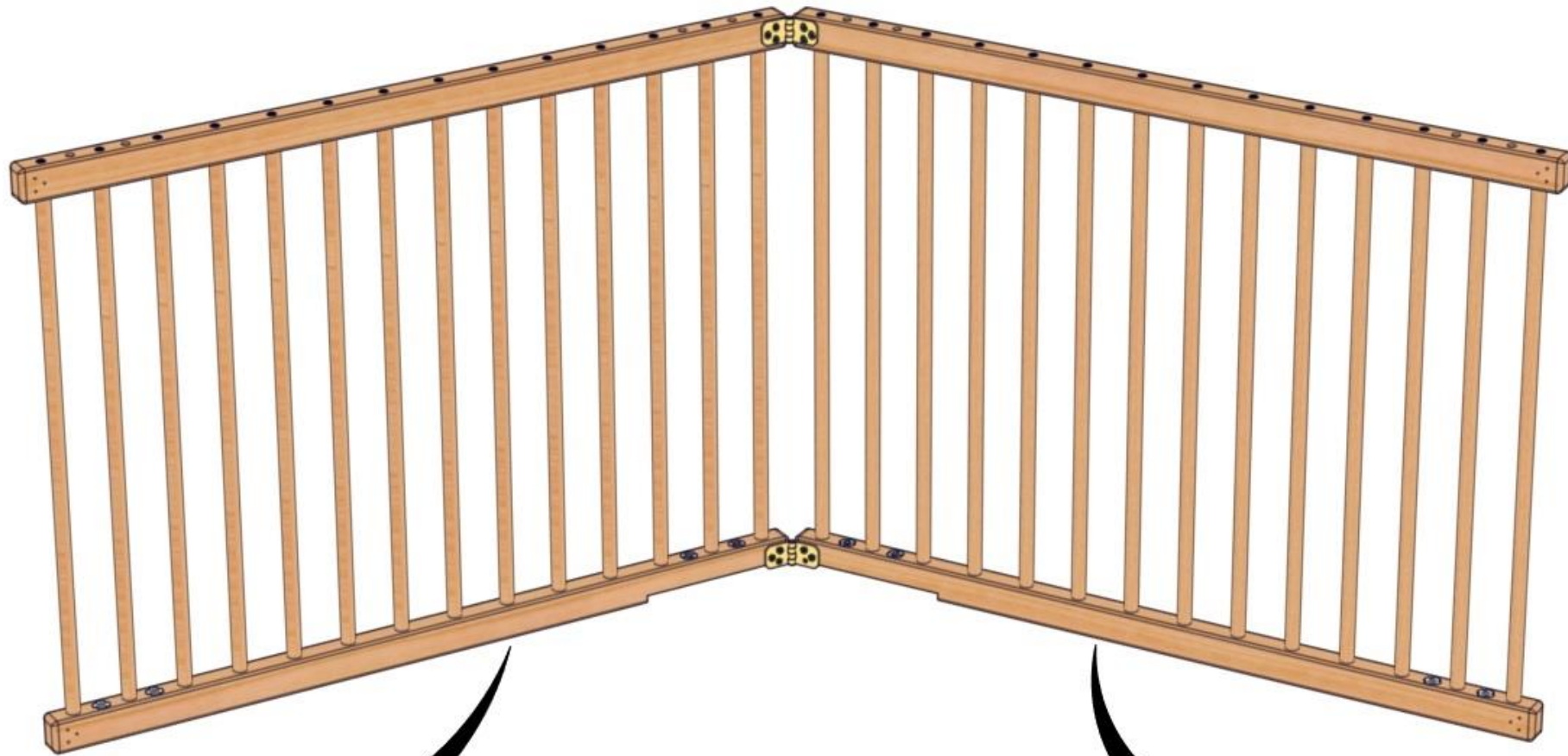
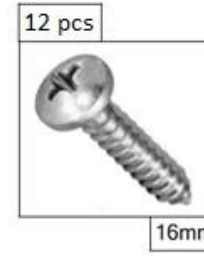
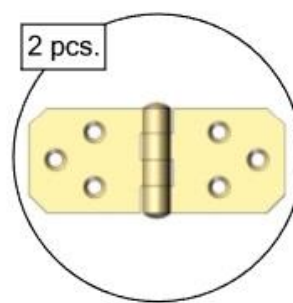

Section 2

Section 3

# Final assembly and shaping

Using parts 9, 10 and 11 assemble as you like.

