

Busy Wood Model 1

Legs & Slats

75x54

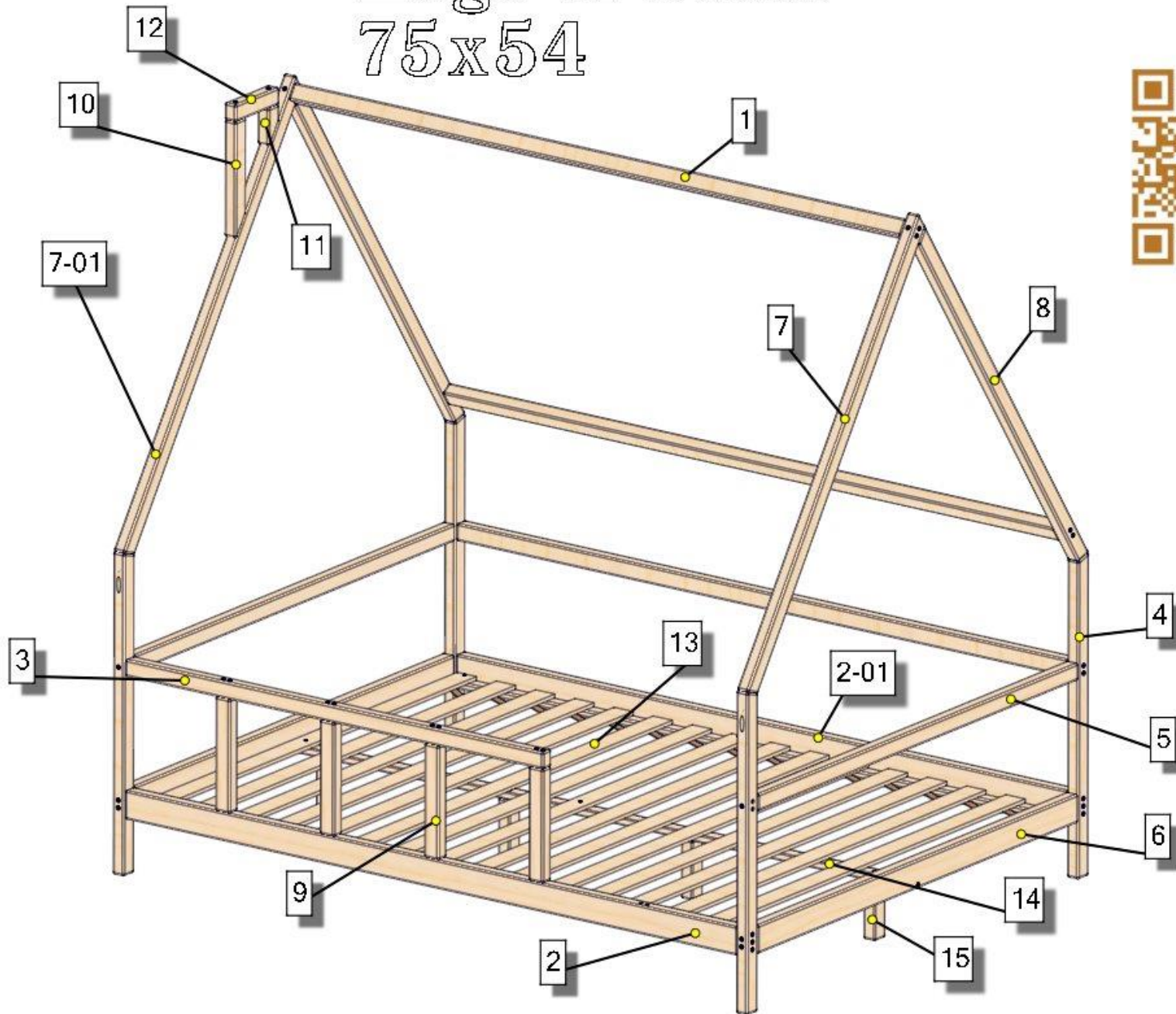

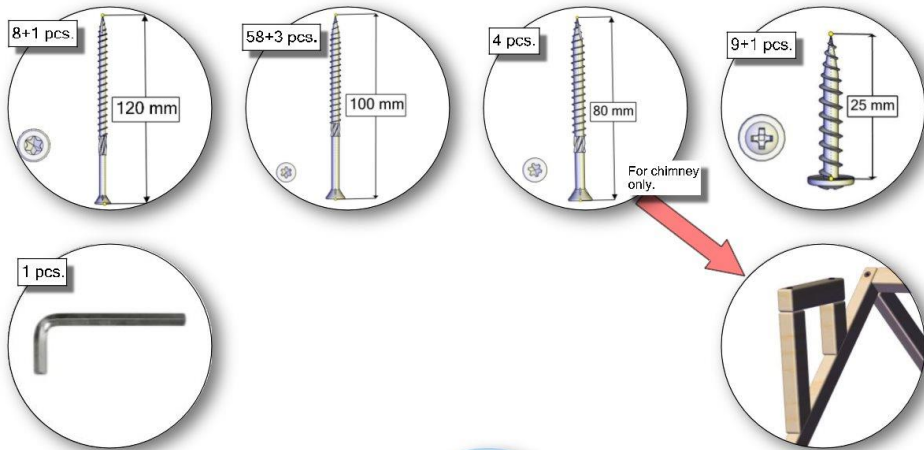

You need:

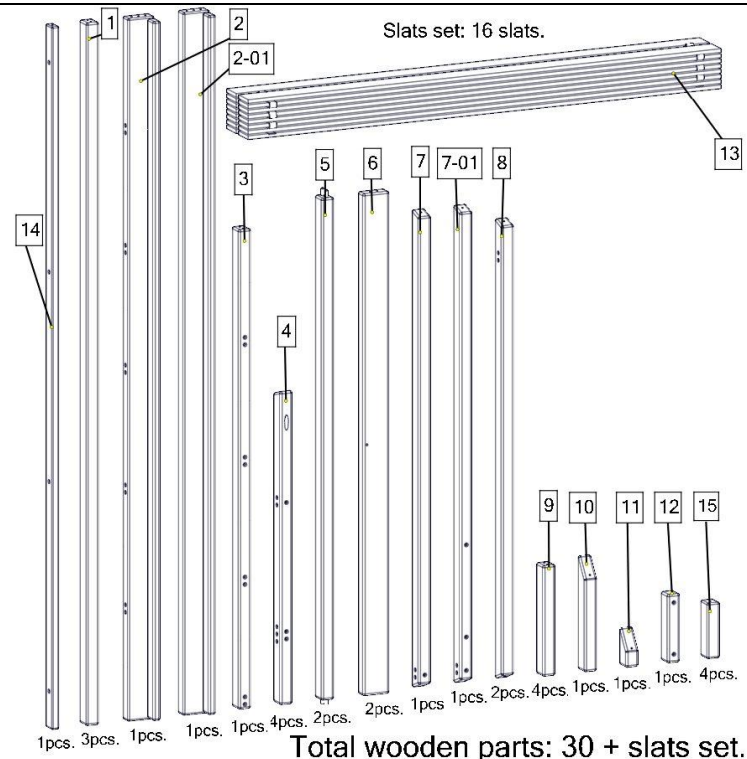
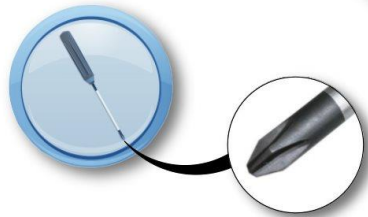

Assembling the base

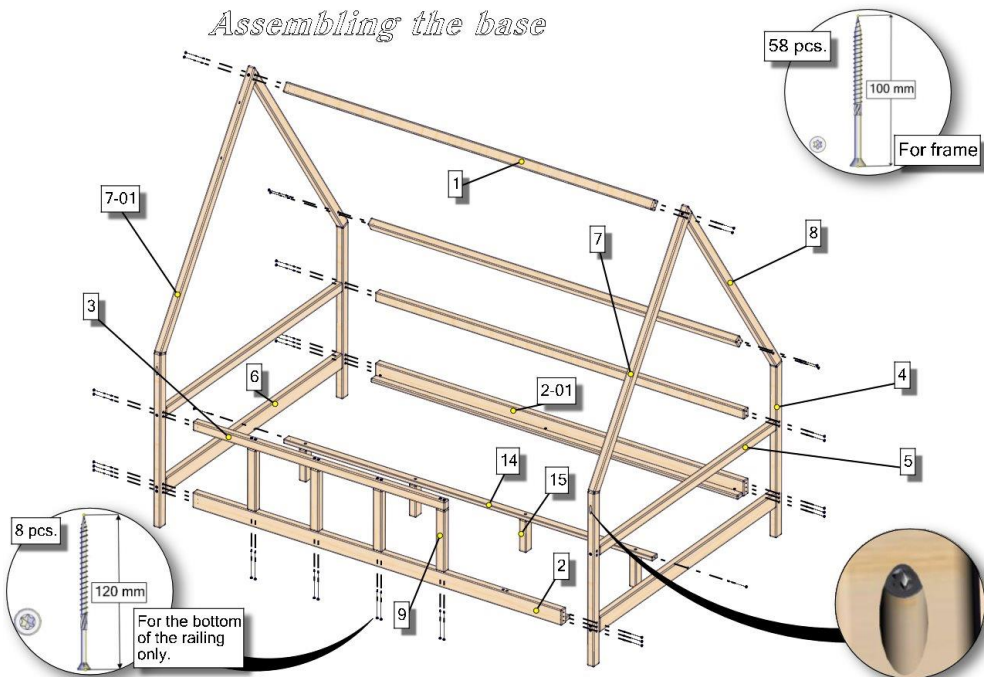

Final assembly

