

Kids Dresser "City" Size M

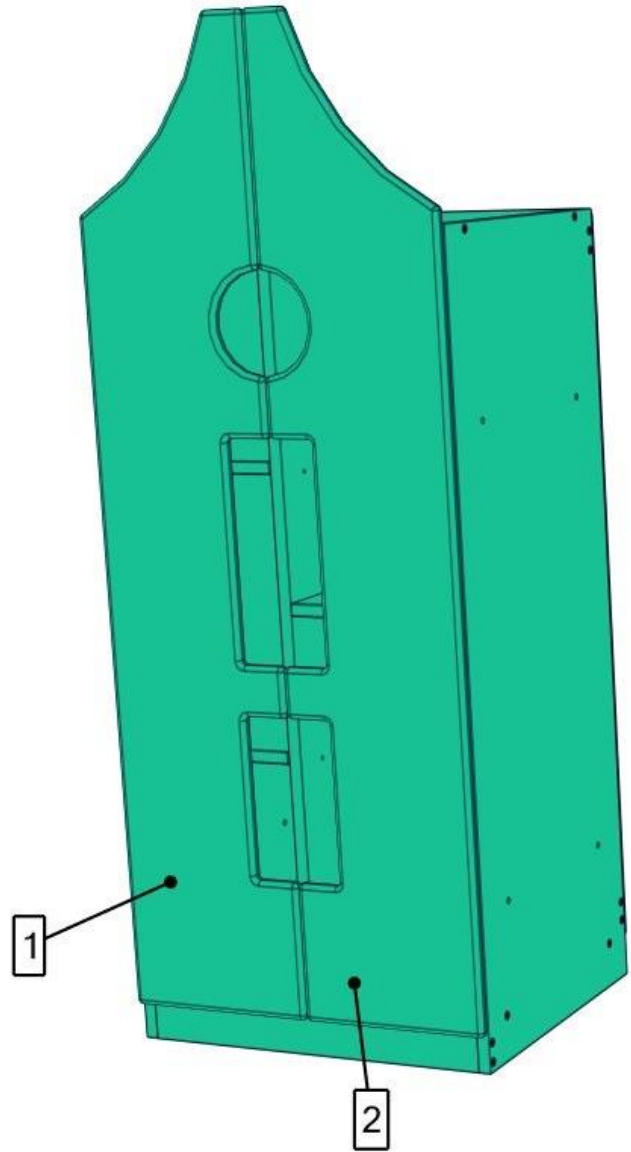

Dresser without doors

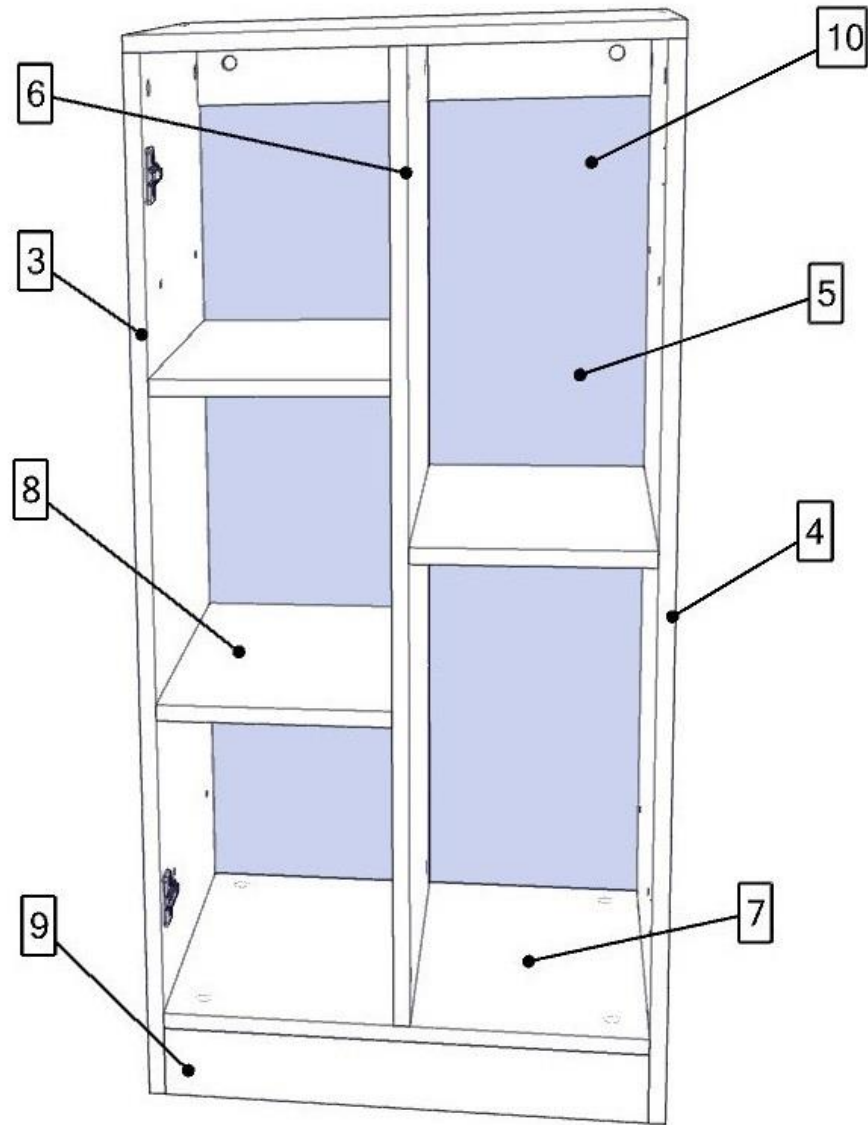

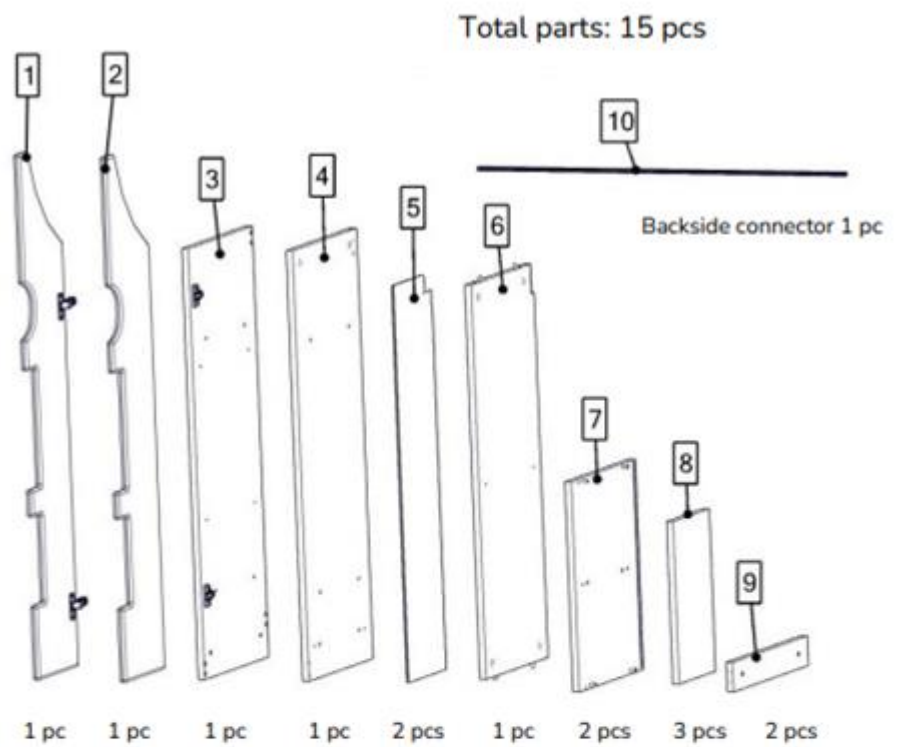
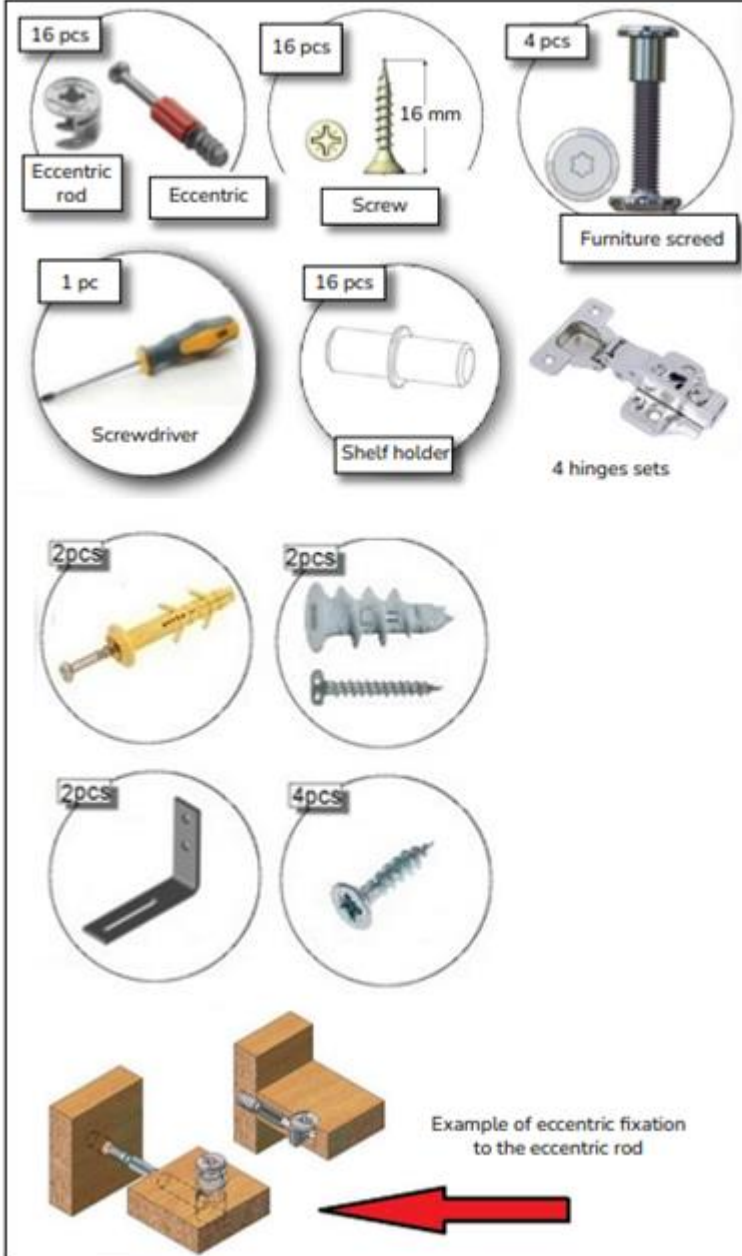

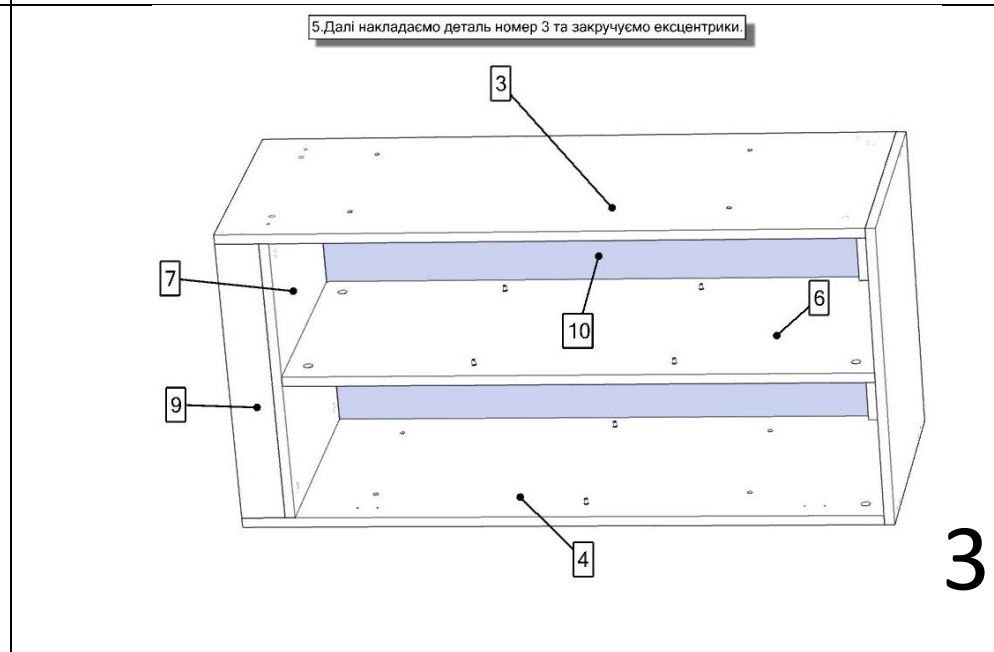
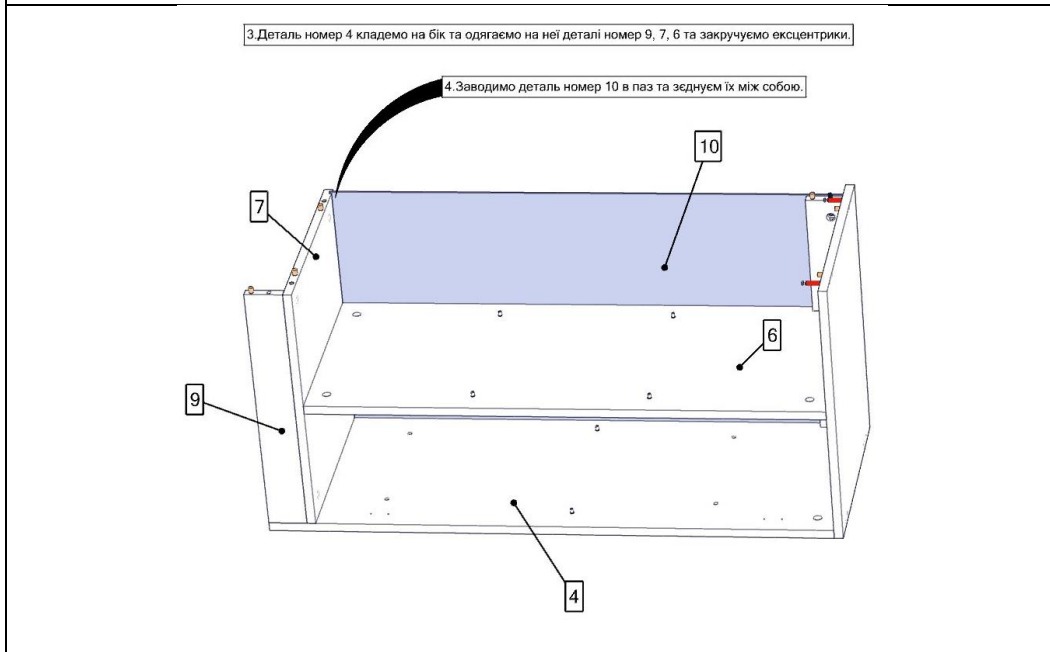
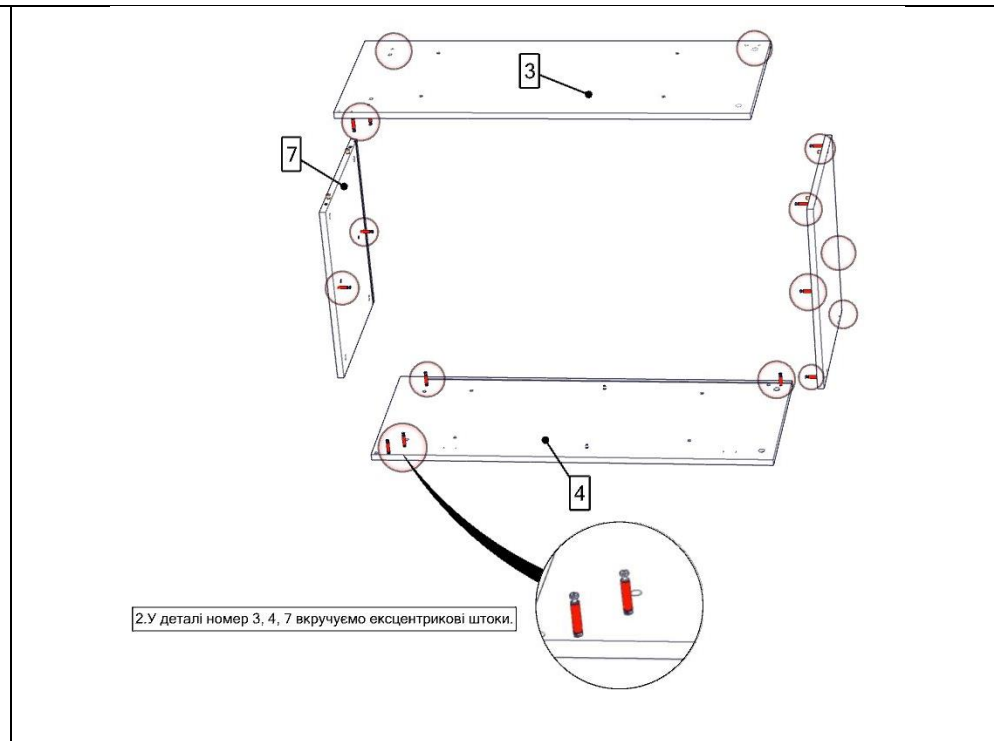
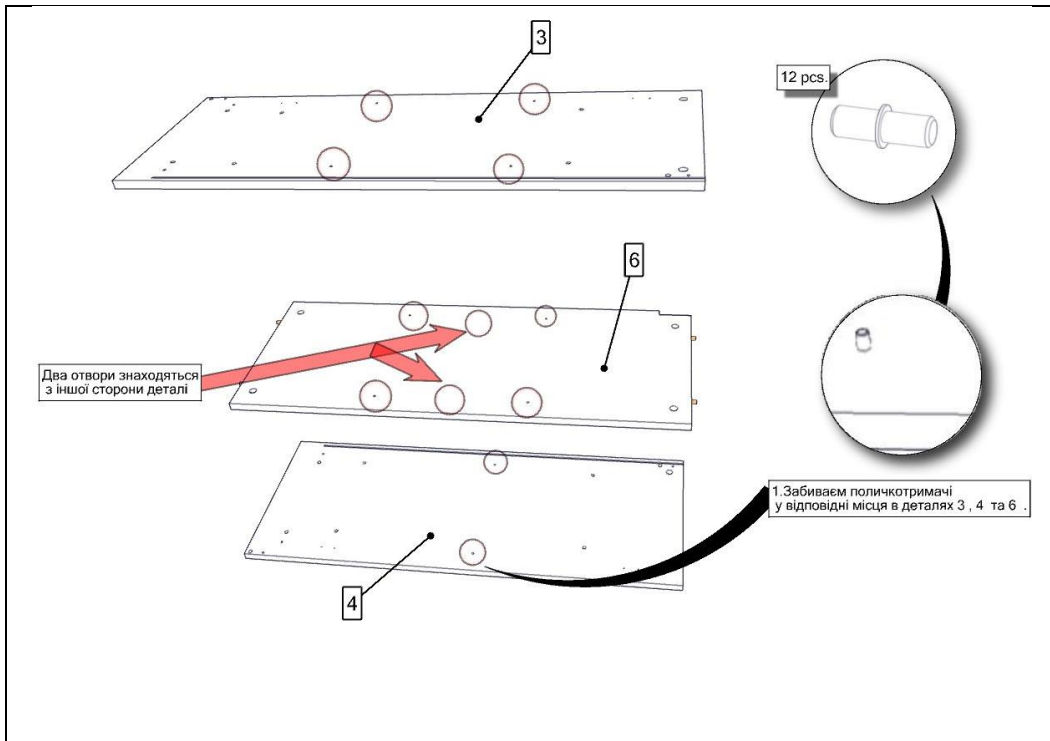

6. Вкладаємо полицки на полицко тримачі.
Робимо це під кутом, відносно бокових стінок.

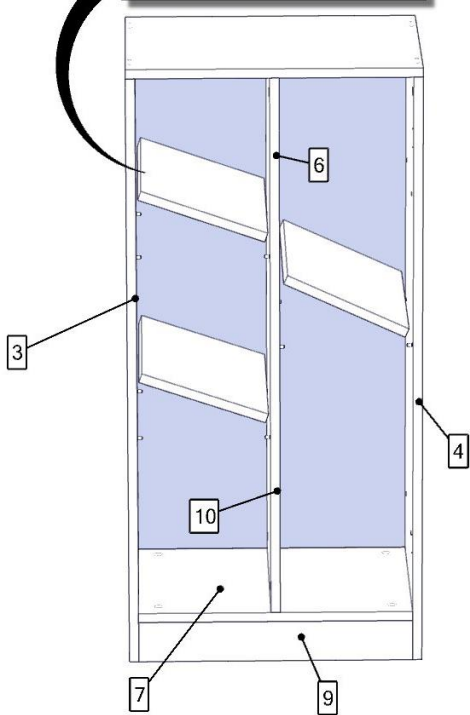

Door assembly

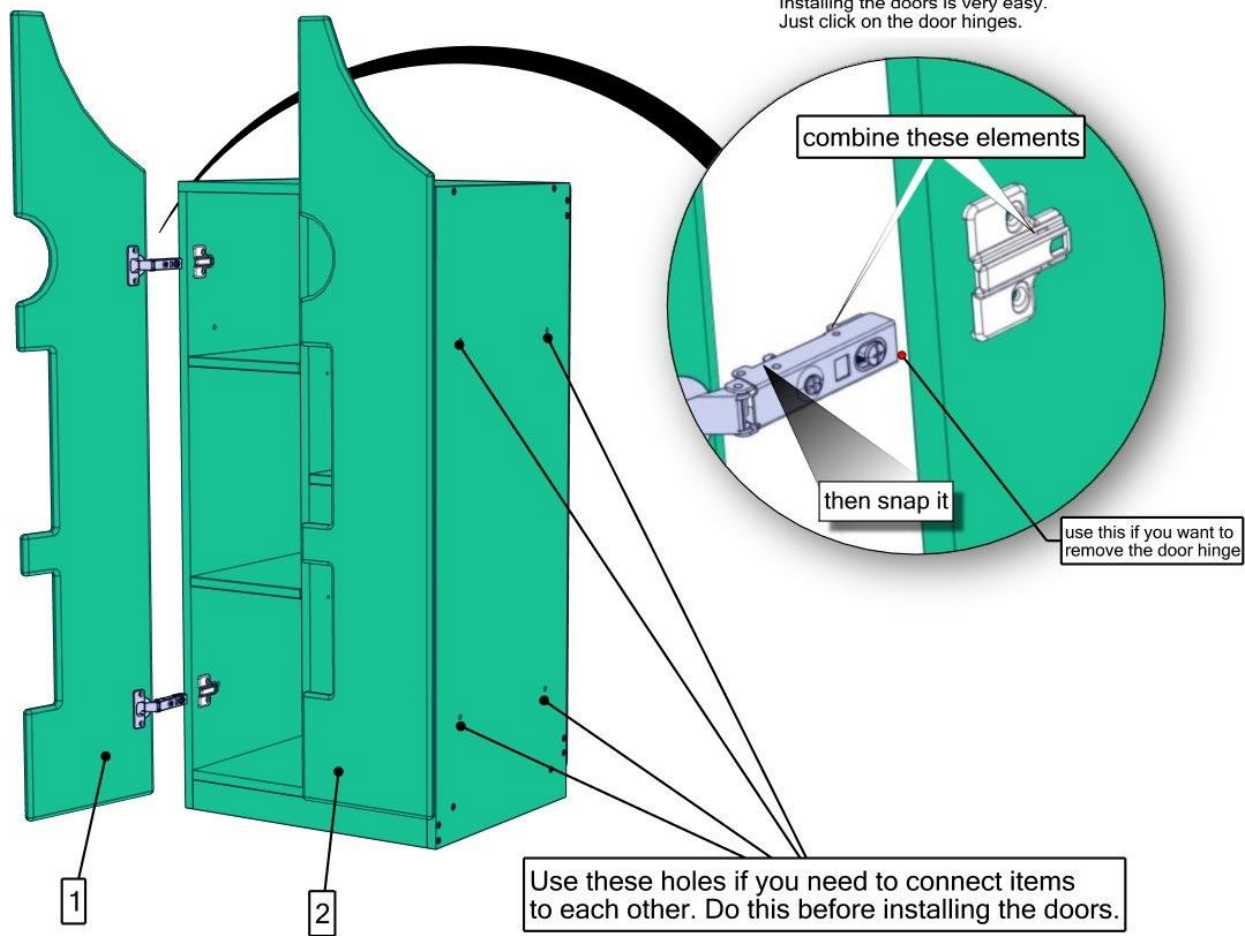

Installing the doors is very easy.
Just click on the door hinges.

combine these elements

then snap it

use this if you want to remove the door hinge

Use these holes if you need to connect items to each other. Do this before installing the doors.

Wall mounting (if necessary)

