

SNAPCYCLE

ELECTRIC BICYCLE

Snapcycle Warrior

User's Manual

ENGLISH MANUAL

Snapcycle Inc.
5318 E. 2nd St
Long Beach, CA 90803

www.snapcycle.com

Contents

| | |
|---|----|
| 1. Preface | 1 |
| 1.1 Welcome | 2 |
| 1.2 About this manual | 2 |
| 1.3 Symbols used in the manual | 2 |
| 1.4 Service & technical support | 2 |
| 2. Safety | 3 |
| 2.1 Safe Use of the E-bike | 3 |
| 2.2 Battery and Charger Safety | 4 |
| 2.3 Changing Components or Adding Accessories | 4 |
| 3. Unboxing & Assembly | 5 |
| 3.1 Overview | 5 |
| 3.2 Cockpit | 6 |
| 4. Operations | 7 |
| 4.1 Product Specifications | 7 |
| 4.2 Mechanical Checklist | 7 |
| 4.3 First Ride | 8 |
| 4.4 Bike Display and Controls | 9 |
| 4.5 Battery and Charging | 12 |
| 5. Transportation & Storage | 12 |
| 5.1 Transportation | 13 |
| 5.2 Storage | 13 |
| 6. Error Code and Troubleshooting | 13 |
| 7. Maintenance | 15 |
| 7.1 Inspection and Safety Check | 15 |
| 7.2 Cleaning | 15 |
| 7.3 Lubrication | 15 |
| 8. Product Warranty | 16 |
| 9. Safety Disclaimer | 19 |

1. Preface

1.1 Welcome

Congratulations on your purchase of a Snapcycle® E-Bike and welcome to the Snapcycle community.

Snapcycle is committed to providing electric bicycles with state-of-the-art design, and world-class quality. Our corporate goal is to offer everyone a happy and enjoyable ride, which will form some of your memorable moments in your life. Either riding along the beach with loved ones, or riding in a national park with grand-children will all become a source of happiness when you recall such moments down the road in life. It is this commitment to our customers that inspires us to constantly improve the quality of our products and services, and to continuously innovate in order to serve our customers better.

1.2 About this manual

This manual contains important safety, performance, service and maintenance information. Please read all information in this manual before you start riding your new e-bike. Please pay full attention to the safety instructions in this manual and do not overlook them. This manual would give you a thorough understanding of the general functionalities and features of the e-bike and how it should be operated and maintained.

1.3 Symbols used in the manual



WARNING: Warns about a situation that can cause death, serious physical injury and/or material damage if one does not follow the safety instructions.

1.4 Service & technical support

If you have questions after reading this manual, please contact the Snapcycle Help Center.

We are always here to support you.

Snapcycle Help Center: support.snapcycle.com

Email: support@snapcycle.com

Happy Riding SNAPCYCLE® .

2. Safety

2.1 Safe Use of the E-bike

- 1) You need to check the traffic rules and regulations in your area, including but not limited to regulations about bicycle lighting, licensing of e-bikes, riding on sidewalks, laws regulating bike path and trail use, helmet laws, child carrier laws, special e-bike traffic laws. It is your responsibility to know and obey the laws.
- 2) Always wear a helmet when riding your e-bike. Ensure that the helmet fits your head and is securely tightened down. If you attach a seat for children to the e-bike, they must also be wearing a properly fitted helmet at all times.

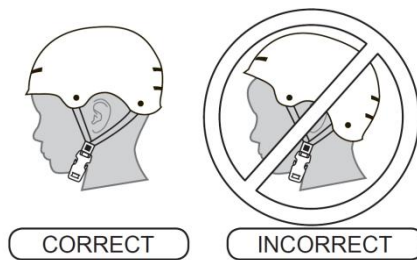

Always read the user manual of the helmet to make sure it is fitted and attached properly to the wearer's head according to the fitting instructions described in the user manual.



Warning: Failure to wear a helmet when riding may result in serious injury or death.

- 3) Before using the e-bike on the road, ride the e-bike in a secure area to get familiarised with riding the e-bike with electric pedalling assistance and its functionalities.
 - Conduct mechanical and electrical checks following the pre-riding checklist in Section 4 of this manual to ensure the e-bike is safe to use.
 - This bicycle is made to be ridden by one rider at a time for general transportation and recreational use. It is not made to withstand the abuse of stunting and jumping.
 - Wet weather impairs traction, braking and visibility. The risk of an accident is dramatically increased in wet conditions. Ride slowly with caution, especially when turning.
 - Riding a bicycle at night is much more dangerous than riding during the day. It is recommended to not ride at night if possible. If you indeed to ride at night, you need to install a tail light on the e-bike and ensure it has sufficient battery power. Ride at slow speed. Do turn on the head light, and tail light when riding at night. It is recommended for the riders to use additional night lighting system such as flashing light on helmet, adding additional reflectors on the e-bikes on all facets.



Warning: Keep both hands on the grips on the handlebar and the brake levers within reach while riding. Failing to do so can cause you to lose control over the e-bike, and may cause serious injury or death.



Warning: Never exceed the maximum permissible load of the e-bike. Failing to do so may result in structural failure, and cause serious injury or death.



Warning: When pushing the e-bike on pedestrian pathways, the rider needs to turn off the power to avoid any accidental activation of the electric motor, which may result in injury to you or other pedestrians.

2.2 Battery and Charger Safety

- Keep the battery & charger away from water, open window, and open fire.
- Do not use the battery & charger for other purposes other than powering the e-bike.
- Only use the original charger to charge the Snapcycle e-bike battery.
- Do not connect terminals.
- Do not open the battery casing.
- Do not attempt to repair the battery unless you are a specially trained and licensed technician.
- Keep the battery away from children and pets.
- Avoid shock and impact to the battery & charger (e.g. by dropping, smashing).
- Stop the charging procedure immediately if you notice a strange smell or smoke.
- In the unlikely case that the battery is on fire, do NOT try to extinguish with water. Use sand or Carbon dioxide extinguisher instead and call emergency hotline immediately.



Warning: Water may cause the short circuit to the battery, may result in fire and other consequences. Avoid water when using or handling batteries

2.3 Changing Components or Adding Accessories

- Changing the components on your e-bike with non-genuine replacement parts may compromise the safety of your e-bike and may void the warranty. Check with Snapcycle customer service before changing the components on your bike
- Please take note that the use of a third-party trailer may cause extra load stress on your e-bike, which may affect the safe use of your e-bike. Do not modify any original parts of the e-bike to accommodate a third-party trailer. Do not exceed the total permissible load weight of the e-bike as stated elsewhere in this user manual.
- Please note that the use of a child seat can cause extra load stress on your e-bike, which may affect the safe use of your e-bike. Do not modify any original parts of the e-bike to accommodate a third-party child seat. Do not exceed the total permissible load weight of the e-bike as stated elsewhere in this user manual. If a child seat is used, there is a risk of trapping the child's fingers or feet into the wheel. Please take appropriate steps to prevent the trapping of the child's fingers or feet. Always follow the child seat manufacturer's instructions for installation, usage and safety.

3. Unboxing & Assembly

Tools Needed



Small Adjustable Wrench
(Jaws must open at least 9/16 inch.)

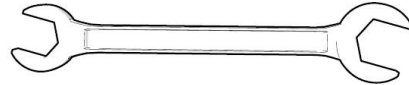

Open-End Wrenches

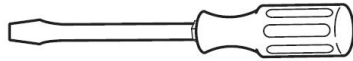

Flat-blade Screwdriver

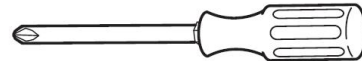

Phillips Screwdriver



Slip-Joint Pliers



Metric Allen Wrenches

You need to follow the unboxing and assembly instruction video that was sent to you via email upon your purchase of the bike. You can also find the video on our product page, under the 'Manual and Assembly Videos' section: <https://support.snapcycle.com/hc/en-us/categories/4403039258777-User-Manuals-and-Technical-Videos>.

If you are unable to find the assembly video, please check your spam/junk folders. You may also write in to us at support@snapcycle.com, or phone us at (415) 888-9135.

3.1 Overview

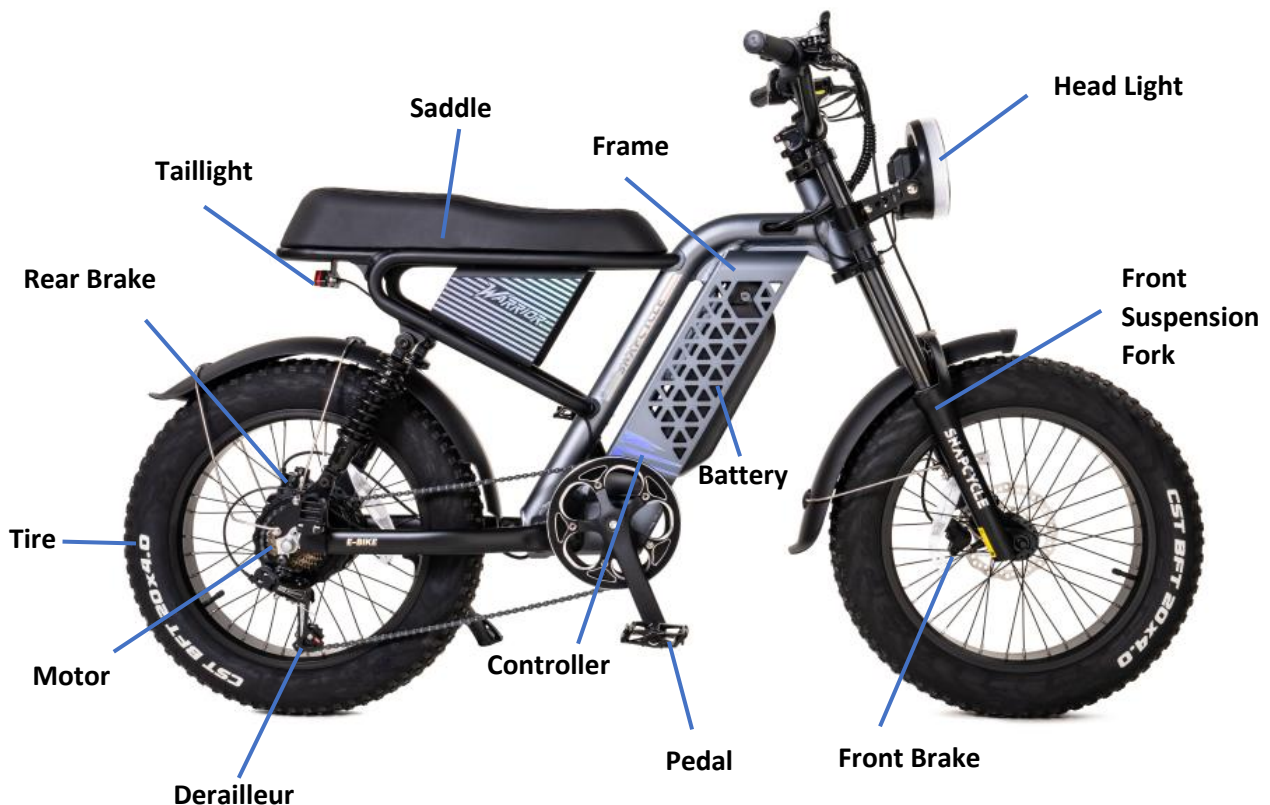

3.2 Cockpit

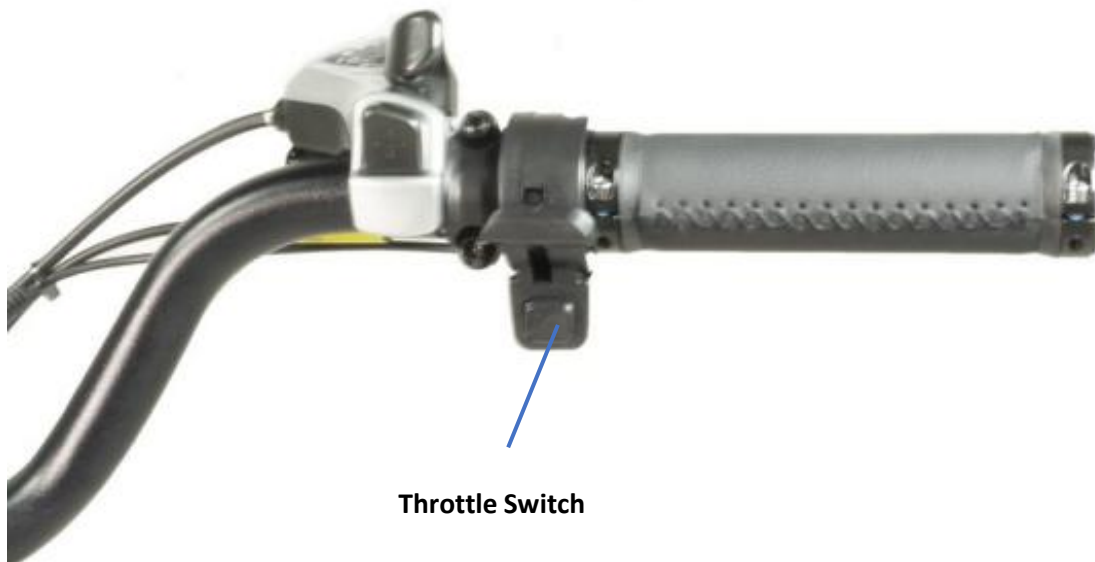
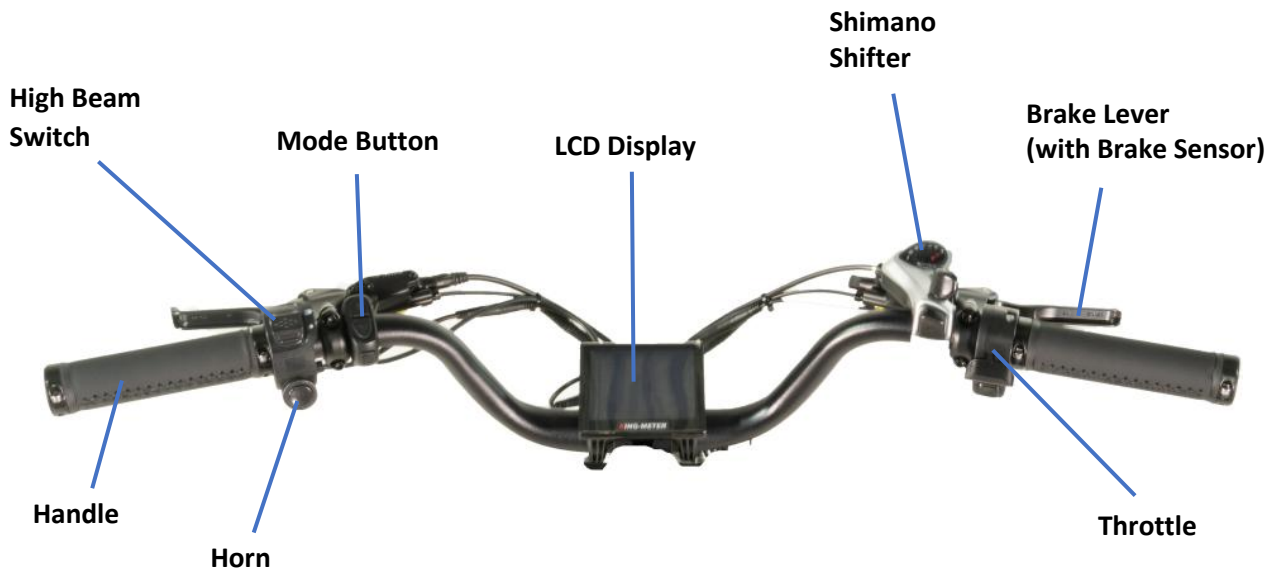

4. Operations

4.1 Product Specifications

| | | | |
|-----------------------------------|---|---------------------------------|---|
| Battery | 48V 16 AH Lithium Battery | Charger | US Standard 3.0A smart charger, UL Certified |
| Range | 30 ~ 60 Miles | Controller | 48V / 22A |
| Electric Bike Class | Class 2 (by default) (Configurable to Class 3) | Display | Adjustable-Angle, Backlit, Grayscale, LCD |
| Hub Motor | 750W brushless geared motor | Frame | Aluminium 6061 |
| Charging Time | 4 ~ 5 Hours | Pedal Assist Intelligent | 0~5 level pedal assist (Configurable to 9-level) |
| Total Payload Capacity | 330 lbs | Top Speed | 20 mph by default (Configurable to 28 mph) |
| Recommended Rider's Height | 4'11" ~ 5' 10" | Net Weight | 70.5 lbs |

4.2 Mechanical Checklist

Before each ride and after every 30 miles of riding, we recommend the following safety checks tabulated in the below tables.

| | |
|------------------|---|
| Fasteners | Check that all fasteners and components are securely tightened |
| Brakes | Check and Test to ensure front and rear brakes work properly Check and ensure the brake pads are not over-worn and are correctly positioned. Ensure brake cables are lubricated, properly adjusted, and has no obvious sign of wear. Ensure brake levers are lubricated and tightly secured to the handlebar. Test that when applying brake, motor cuts off |
| Wheels and Tires | Ensure tires are inflated within the recommended limits posted on the tire sidewalls and do not leak air. Ensure tires have good tread, have no bulges or excessive wear, and are free from any other visible damage. Ensure rims rotate smoothly without any abnormal noise and have no obvious wobbles, dents, or kinks. Ensure all wheel spokes are tight and not broken. Ensure axle nuts are tighten properly and front wheel quick release is correctly tensioned, fully closed, and secured. |
| Seat | Ensure the seat mounting bolts are tightened to the recommend torque value. Ensure the seat quick release lever is properly tightened and secured and check that the seat cannot move. |
| Steering | Perform a handlebar twist test to ensure the handlebar stem is secure. Ensure the handlebar is set correctly in relation to the fork and the direction of travel. |

| | |
|-----------------------------------|---|
| Chain | Ensure the chain is adequately lubricated, clean, and has no visible damage. |
| Bearings | Ensure all bearings are lubricated, run freely, and display no excess movement, grinding, or rattling. heck headset, wheel bearings, pedal bearings, and bottom bracket bearings. |
| Cranks and Pedals | Ensure pedals are securely tightened to the cranks. Ensure the cranks are securely tightened and are not bent |
| Derailleurs | Check that the derailleur(s) are adjusted and working properly. Ensure shift cables and brake levers are properly lubricated and securely attached to the handlebar. |
| Motor Drive Assembly and Throttle | Ensure hub motor is spinning smoothly and motor bearings are in good working order. Ensure all power cables running to hub motor are secured and undamaged. Make sure the hub motor axle bolts are secured and all torque arms and torque washers are in place. |
| Battery Pack | Ensure battery is charged before use. Ensure there is no damage to battery. Lock battery to frame and ensure that it is secured. Charge and store bike and battery in a dry location, between 50 °F – 77 °F. |

4.3 First Ride

For your first ride,



1. You need to fully charge your battery before use. Charge it until the LED on your charger turns green.
2. Ensure the battery key is in LOCKED position
3. Press and hold the power button on the display control pad located on the left handlebar until the display turns on
4. Select your preferred level of pedal-assist using the +(UP) and -(DOWN) button on the display control pad, with Level 1 being the lowest , and Level 5 being the highest. Level 0 provides no assistance to the rider.
5. You will find a half-twist throttle on the right handlebar next to the right handlebar grip. Twist the throttle backwards slowly depending on the speed and acceleration you wish to have. The further you twist the throttle from its original position, the more power you will have from the motor propelling the ebike forward. Your throttle control will be disabled if your PAS level is at 0. You need to increase the PAS level to 1 or above in order to activate your throttle control.
6. To turn on the headlight and taillight, press and hold the UP button to turn them on. To turn them off, press and hold the UP button again.
When you close any of the brake levers, the rear brake light will be lit.
7. When the ebike comes to a complete stop, turn off the power by long pressing the power button on the display control pad until the LCD display turns off. This is to ensure that the motor will not be accidentally activated.

CAUTION: when you are not riding the bike, but with the power on, be careful not to accidentally twist the throttle, which may throw you off balance and cause serious harm, injury or death.

4.4 Bike Display and Controls

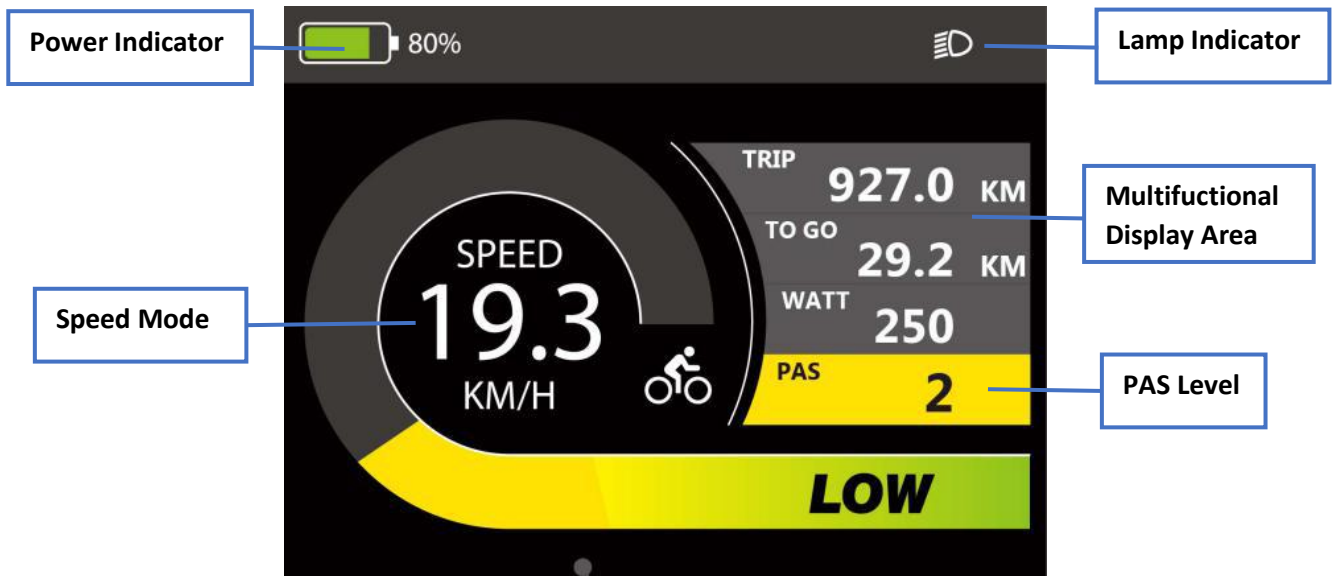
4.4.1 Functional Description of the Display



- **Speed Mode:** Average Speed (AVG SPEED), Maximum Speed (MAX SPEED), Real-time Speed (RT SPEED).
- **Speed Bar:** It shows the speed value in KM/H or MPH
- **Power Indicator:** It shows the power level of the battery. The corresponding voltage for each level can be adjusted by the user.
- **Lamp Indicator:** When the headlight is on, this symbol  will show up.
- **PAS Level:** It shows the current pedal-assist level (0 ~ 5), with 0 being no pedal-assist, 5 being the highest pedal-assist
- **Error Indicator:** When the system detects a fault, this symbol  will show up.
- **Brake Indicator:** When the rider applies any of the brakes, this symbol  will show up.
- **Multifunctional Display Area:** It shows the mileage value (Trip, Odo, or Running Time)

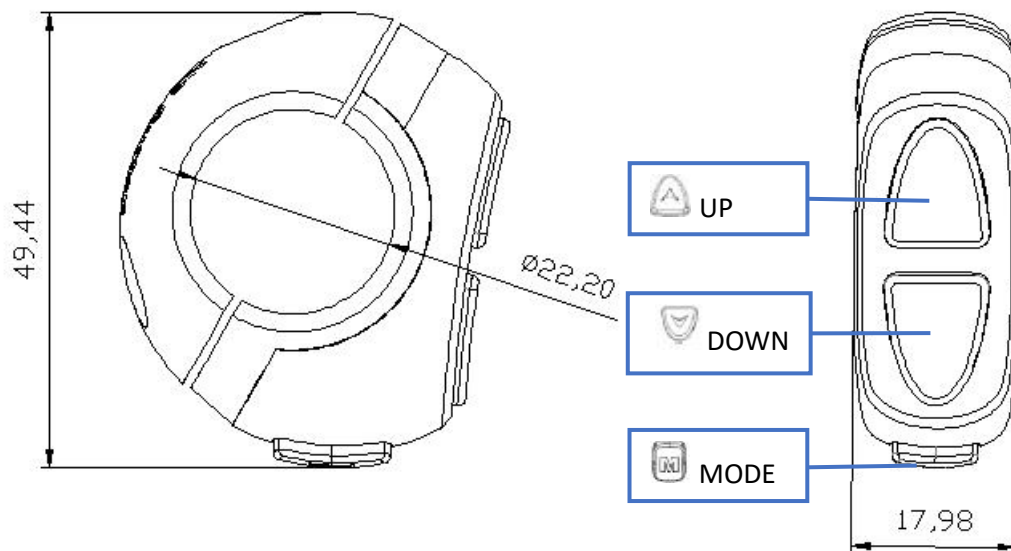

4.4.2 Display Control Pad



Power On/Off



Press and hold  button for 2 seconds to turn on/off the display. The control system will automatically shut down if there is no operation and riding by the user for X minutes (X could be between 0~9 and can be set by the user).

Pedal-Assist Levels

Turned on display. Click  button to PAS+1. Click  button to PAS-1. (The default is PAS1)

Walk Mode

Under the interface of normal speed display. When the Ebike is stationary, press and hold  button will enter 6KM/h in walk mode.

(The walk mode is divided into locked mode and non-locked mode. Locked mode: After press and hold  button enters the walking mode, the Ebike still maintains the walk mode after releasing the button. It needs to press and hold  button again or brake to exit the walking mode. Non-lock mode: Press and hold  button and the walk mode will take effect. Release the button to exit the walk mode.)



Multi-function display



Turned on display. Click  button to switch the multi-functional to display interface at the bottom of the screen will switch between ODO、TRIP、VOL、CUR、TM and ODO are displayed by default after each turn on display. (" TIME "is a single running TIME)







Headlight On/Off

Turned on display. Press and hold  button to turn on/off the front light under the normal display speed interface.

Speed mode display

On the normal display speed interface, press and hold  button and  button switches the average speed, maximum speed and real-time speed successively. (Default display the real-time SPEED)

Press and hold  button and  button enter Settings

Parameter value modification: under a parameter state, press  button switch Parameters, press  button value plus one, press  button value minus one. And when it's modified, press  button switch to the next parameter and save the previous parameter value; Press and hold  button and  button again to save and exit the settings. If not, wait 8 seconds to automatically exit and save the parameters.

ODO cleared

On the P16 menu interface. Press and hold  button for 5 seconds to cleared ODO.

Reset defaults

On the P16 menu interface. Press and hold  button for 2 seconds to reset all defaults. (This operation can not cleared ODO)

4.5 Battery and Charging

4.5.1 Charging

To charge the battery,

- You need to charge it at room temperature , preferably around 68 °F. Charging below 32 °F or above 104 °F may significantly shorten the lifespan of the battery
- Do not charge it immediately after use. It is recommended to leave it there for half an hour after riding the bike, before charging the battery.
- Plug in the charging cord into the charging port located at the right hand side of the main frame (Refer to Section 3.1 to locate the charging port)
- Connect the charger to the main power outlets, and switch on the power.
- When the LED on the charger is red, it shows charging is in progress. When the charger LED turns green, it shows the battery is fully charged.
- You can also remove the battery from the bike, and charge it separately , following the instructions shown in the Section 4.5.2 below.

4.5.2 Removing the battery

To take the battery off from the bike, you can follow the steps shown in the schematic below.

Step 1: Ensure battery power is turned off. Insert the battery key into the battery lock, and switch to UNLOCKED position

Step 2: After the battery is unlocked, hold the battery with your hand and push it up to take out the battery.

Step 3: Remove the battery from the bike, please hold it in your hand and take.

Step 4: When installing the battery, snap the battery downward into the fixed position and lock the battery with the key.

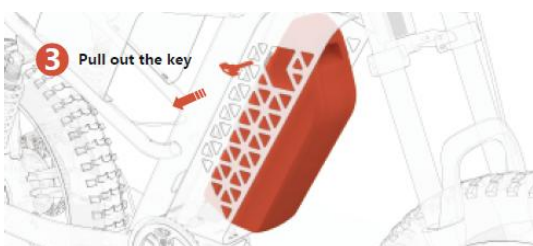
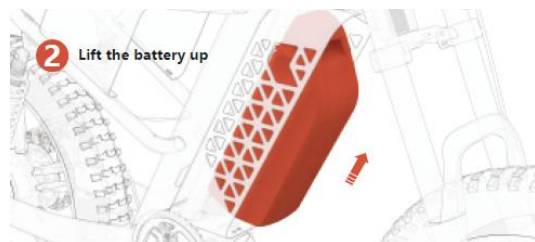
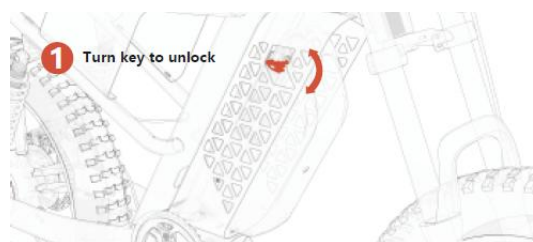

5. Transportation & Storage

5.1 Transportation

CAUTION: Batteries are not designed to be on the bike during transportation by car. Batteries must be taken off the bike(s) and transported inside the car.

5.2 Storage

Store the bike in a location where it is protected from snow, rain, sun etc. Snow and rain can cause the bike to corrode. The ultraviolet light from the sun can fade the paint or crack any rubber or plastic on the bike.

If the ebike is not used for a long period of time (one month or more), the battery should be stored:

- At 50%- 60% of its capacity (you should have 4 bars left on the battery indicator)
- Separate from the bike
- At temperatures between 32°F – 105 °F, preferably between 50 °F – 77 °F.

NOTE: Check the battery every month by looking at its battery level shown on the battery LED indicator. Charge the battery if necessary.

CAUTION: Charge the battery every 3 months. Negligence to do so may void the warranty of the battery.

6. Error Code and Troubleshooting

Snapcycle LCD display will show a warning message with this  icon on the screen, and also show error codes on the screen, listed in the table below.

Appendix 1: Error Code Definition

| Error Code | Definition |
|------------|--|
| 0x05 | Throttle abnormal |
| 0x07 | Under voltage protection |
| 0x08 | Motor Hall abnormal |
| 0x09 | Motor phase cable failure |
| 0x10 | Controller high temperature protection |
| 0x11 | Motor high temperature protection |
| 0x12 | Current sensor failure |
| 0x13 | Battery temperature failure |
| 0x14 | Motor temperature sensor failure |
| 0x15 | Controller temperature sensor failure |
| 0x21 | Speed sensor failure |
| 0x23 | Headlight fault |
| 0x24 | headlight sensor failure |
| 0x25 | Torque sensor torque signal failure |
| 0x26 | Torque sensor speed failure |
| 0x30 | Communication failure |

If you have any error problems, please contact Snapcycle customer support team via email at support@snapcycle.com.

7. Maintenance

7.1 Inspection and Safety Check

Before every ride and after every 50 miles of ride, the e-bike should be checked regularly following the checklist as described in Section 4.2. Regular inspections and tuning are crucial to ensure that your ebike remains safe and fully functional.

7.2 Cleaning

Use a soft cloth with a neutral solution to wipe the dirt off the bike surface. After that, wipe it dry with a clean soft cloth.

CAUTION:

Do not use high-pressure water jets for cleaning. It can cause water ingress into electric components, which may damage them.

Do not wash the E-bike components with excessive water. If water penetrates into the internal electrical parts, it may cause low insulation, and lead to power draining out fast, or battery damage.

Riding on the beach or in coastal areas will expose your bicycle to salt which is very corrosive to metals. Wash your bicycle frequently and wipe or spray all unpainted parts with anti-rust treatment. Damage from corrosion is not covered under warranty so special care should be given to extend the life of your bike especially when used in coastal areas.

7.3 Lubrication

To properly maintain your bike, it is highly recommended to lubricate the rotating components regularly.

NOTICE: Do not over lubricate. If oil gets on the wheel rims or the brake shoes, it will reduce brake performance and a longer distance to stop the bicycle will be necessary. Injury to the rider or to others can occur.

| What | When | How |
|--------------|------------------|---|
| Pedals | every six months | Put two/three drops of oil where the axles go into the pedals |
| Chain | every six months | Put one drop of oil on each roller of the chain. Wipe off all excess oil with a clean soft cloth. |
| Shift levers | Never | Do not lubricate the shift levers |

| | | |
|------------------------|------------------|---|
| Derailleurs | every six months | Put one drop of oil on each pivot point of the derailleur. Wipe off all excess oil with a clean soft cloth. |
| Brake and Brake Cables | every six months | Apply two / three drops of oil into both ends of the cable. Allow the oil to penetrate into the cable. |
| Brake levers | every six months | Put one drop of oil on each pivot point. Wipe off all excess oil with a clean soft cloth. |

8. Product Warranty

We at Snapcycle proudly stand behind the quality and reliability of our products while promising you some of the best customer service experiences in the industry.

WARRANTY PERIOD

Snapcycle Inc. ("Snapcycle") warrants all new Snapcycle electric bicycles and its Covered Components to be free from defects in material and workmanship for two (2) year from the date of delivery, subject to the terms and conditions specified herein. This limited warranty only applies to the original buyer who must be able to provide electronic proof of purchase by means of order number, email address and name used at the point of original purchase, and is not transferable to subsequent owners. During its warranty period, any defective parts will be repaired or replaced free of charge for the customers. However, please note that the warranty period for a repaired or replaced part remains unchanged based on the original delivery date of the ebike.

COVERED COMPONENTS

The components covered under this limited warranty includes frame, forks, stem, handlebar, seat post, saddle, brakes, lights, bottom bracket, crankset, pedals, rims, wheel hub, freewheel, cassette, derailleur, shifter, motor, controller, LCD display, battery, and electrical sensors.

BATTERY WARRANTY

Snapcycle batteries are covered by one (1) year pro-rated warranty. If a battery is found defective or its capacity falls below 60% of its rated value within the warranty period, it will be repaired free of charge for the customers. However, the shipping cost for return is to be borne by the customer. The warranty period for a repaired or replaced battery remains unchanged based on the original delivery date of the ebike. However, please take note to follow the instructions listed below to prevent your battery warranty from being void.

- Do not charge it below 32 Fahrenheit, or above 105 Fahrenheit
- Do not charge it immediately after riding your ebike. Let it cool down to ambient temperature before charging it
- Protect your battery from water ingress
- Charge it at least once a month

WARRANTY EXCLUSIONS

- Consumables or normal wear and tear parts (including but not limited to tires, brake pads, cables and housing, grips, chain and spokes) are not covered under warranty

- Any damage or defects to Covered Components resulting from the following causes are not covered by warranty: failure to follow instructions in the user's manual, force majeure, accident, misuse, neglect, abuse, alterations and modification without written consent from Snapcycle, assembly and repair works by any unauthorized third party, installation of parts or accessories not originally intended or compatible with the ebike as sold, operator error, water damage, extreme riding, or improper follow-up maintenance.
- Any damages resulting from improper use, such as by overloading the ebike above its rated load capacity, or by raising the seatpost above its minimum insertion mark.
- Products that are used for competition or commercial activities, including without limitation rental / lease, are not covered by this limited warranty, unless otherwise agreed by Snapcycle.
- Any gifts or accessories that come along with the ebike free of charge are not covered by this limited warranty.
- This limited warranty is not applicable to the sale of spare parts and accessories.
- Any damage resulting from the use of a third-party battery charger not originally supplied by Snapcycle is not covered by warranty.
- Snapcycle will not cover any damage that may occur during shipping if the purchaser uses their own shipping option

SHIPPING DAMAGE CLAIMS

We are confident in our product quality. However, there is a rare chance that your product(s) may get damaged during shipping. You are well advised to inspect your product(s) immediately upon receiving them. In the unfortunate event that you find any damage to your product(s), take photos from different angles, keep all packaging and paperwork, and contact Snapcycle by email at support@snapcycle.com immediately. Please take note that we will not accept shipping damage claims later than 14 days from receipt of the product(s).

WARRANTY CLAIMS

If you suspect any component of your ebike is defective, all warranty claims must be submitted to Snapcycle via email to support@snapcycle.com. Please do not attempt to repair or replace it yourself before contacting Snapcycle, as doing so may void your warranty and cause consequential damages to your ebike, undermining its safety and reliability.

You would need to describe in detail what issues you are facing and attach some clear photos or videos for easy understanding. Upon receiving your claims, our dedicated customer service team will firstly provide remote assistance to you via email/calls as there might be an easy fix to your problems.

If our customer service team determines that a replacement part is needed, they will provide you with clear instructions for returning the defective parts, and receiving the replacement. Shipping charges are to be borne by the customers. It is at the full discretion of Snapcycle to determine if a defective component is covered by this limited warranty.

For warranty services, please contact Snapcycle Help Center.

Snapcycle Help Center: support.snapcycle.com

Email: support@snapcycle.com

Snapcycle service team may request additional information such as video and photography to assist with processing of the warranty claims. Snapcycle e-bikes or parts returned without prior authorization and proper documentation may get lost, and may cause delay to the entire process. Warranty return shipping costs, duty and taxes are to be borne by the claimant.

Our dedicated service team will always be at your disposal for technical assistance and troubleshooting.

9. Safety Disclaimer

Electric bicycles are powerful machines designed for use by adults in fully controlled and safe environments. Most electric bicycles can be ridden where other non-motorized bikes are allowed, but it is your responsibility to check and obey all local laws. Your electric bicycle should only be ridden in safe areas where all laws are being followed and all required permissions are given.

Because it is impossible to anticipate every situation or condition which can occur while riding, Snapcycle, Inc. makes no representation about the safe use of their electric bicycles under all conditions. It is the responsibility of the riders to ensure the ebike is properly assembled as per our instruction manuals or videos, and ensure all bolts, nuts, fasteners, quick release clamps are securely fastened before riding. There are risks associated with the use of an electric bicycle which cannot be predicted or avoided, and which are the sole responsibility of the rider.

Snapcycle does not accept any liability or responsibility for any accident or injury incurred as a result of the use of any of their electric bicycles or any other product.

LIMITATION OF LIABILITY: TO THE FULLEST EXTENT PERMISSIBLE PURSUANT TO APPLICABLE LAW, SNAPCYCLE, INC. LLC, THEIR AFFILIATES, FAMILY AND FORMER AND CURRENT EMPLOYERS NOR ANY OTHER PARTY INVOLVED IN CREATING, PRODUCING OR DELIVERING SNAPCYCLE PRODUCTS IS LIABLE FOR ANY DIRECT, INCIDENTAL, CONSEQUENTIAL, INDIRECT, EXEMPLARY, OR PUNITIVE DAMAGES ARISING OUT OF A USER'S ACCESS TO, OR USE OF SNAPCYCLE PRODUCTS.

BATTERY USE RISK

Improper use, care, or charging of a lithium-Ion battery could cause serious injury to the product, property, or persons. If the battery is tampered with or damaged in any way, do not use the product and find a hazardous waste removal center immediately. It is the responsibility of the purchaser to maintain safe storage and treatment of the battery at all times. Only use the charger that came with your product. Just because a charger fits in your device doesn't mean that it is safe to use.

Keep your device out of extremely high or low temperature locations. Do not place the battery in direct sunshine, or store the battery inside cars in significant hot or cold weather.

Do not expose the battery to water or allow the battery to get wet.

Do not continue charging the battery if it does not recharge within the specified charging time. Doing so may cause the battery to become hot, explode, or ignite.

Do not use your device if you notice any damage to the battery after dropping it. If you suspect damage to the battery, email our support or dispose of the battery and order a replacement.

Do not disassemble or modify the battery in any way. Modifying your electronic significantly increases the risk of explosion and will also void all warranties.

OWNER'S MANUAL

Please reference this Owner's Manual which provides important information regarding safety and maintenance of your electric bike. Please read through the entire manual prior to operating your electric bicycle and save the manual for future reference.

If at any time you have questions or need assistance with the maintenance of your product, you may contact us at support@snapcycle.com or you may contact the manufacturer using the information included in this Owner's Manual.