

JAZZ SERIES

Vibrant, Full Color RGB Systems

JAZZ ULTRA RGB SYSTEM COMPONENTS

RGB
Controller



US1621

OR



US2PXL

RGB
Modules



US1620B



US1630



SYSTEM CONFIGURATION

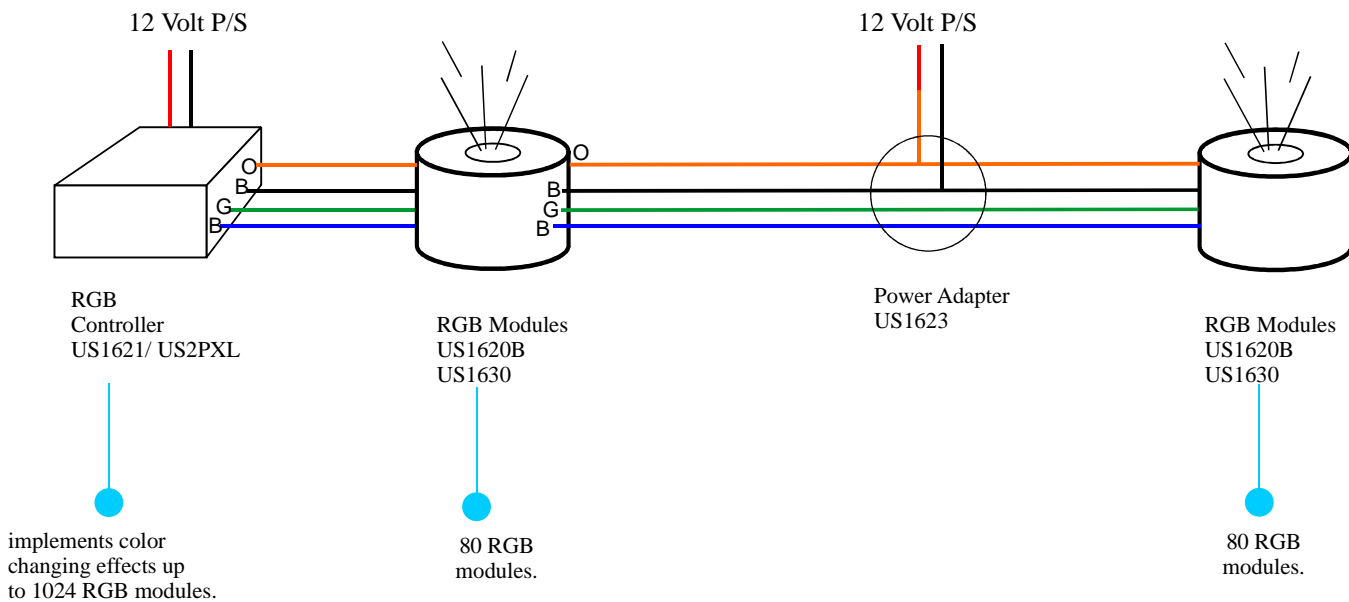

SYSTEM FEATURES

RGB controller US1621/US2PXL can address and specify color changing effects for each US1620B/US1630 RGB module. Each US1620B/US1630 RGB modules has embedded ID.

RGB controller US1621/US2PXL can address a maximum of 1024 RGB modules individually. To avoid voltage drop and current overloading along the line, a new power supply is added for every 80 RGB modules.

Controller US1621 comes with 48 pre-set programs.

Controller US2PXL is programmable and can store up to 64 programs. There are 32 pre-set programs, 24 custom-programmable programs and 8 macro programs which combine preset/custom programs to show color changing effects. Program customization available upon request.

Remote key pad included.