







JAZZ SERIES

Vibrant, Full Color RGB Systems

JAZZ STANDARD RGB SYSTEM COMPONENTS

<p>RGB DMX Controller</p>  <p>US2ARC</p> <p>OR</p>  <p>US2ARC-NET</p>	+	<p>ID Driver</p>  <p>US1422</p> <p>OR</p>  <p>US1522S</p>	+	<p>RGB Modules</p>  <p>US1520</p>  <p>US1120</p>	+	<p>Data Repeater</p>  <p>US1423 (Optional)</p>
---	---	---	---	--	---	---

SYSTEM CONFIGURATION

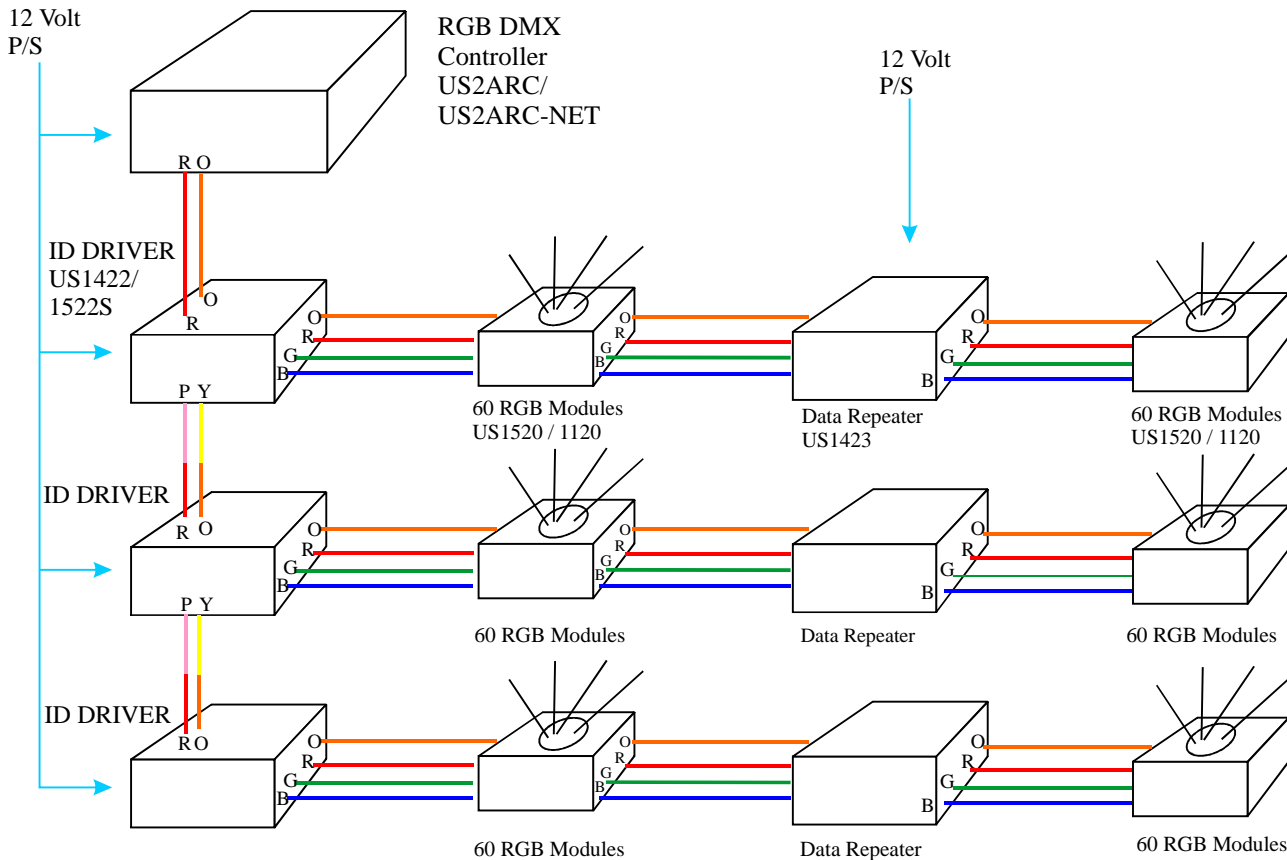

SYSTEM FEATURES

RGB DMX controller assigns and implements color changing effects on clusters of RGB modules. An ID Driver heads the cluster and drives up to 60 RGB modules. A data repeater is added to extend the data signal to another 60 RGB modules.

US2ARC can assign addresses up to 170 ID drivers. It is custom-programmable and stores up to 40 programs. There are 16 pre-set programs, 16 custom-programmable programs, and 8 macro programs which combine preset/custom programs to show color changing effects. Program customization available upon request.

US2ARC-NET is the network version which provides the option to change effects thru networking computer. It can assign addresses up to 170 ID drivers. It is custom-programmable and stores up to 64 programs. There are 32 pre-set programs, 24 custom-programmable programs, and 8 macro programs which combine preset/custom programs to show color changing effects. Program customization available upon request.

Remote key pad included.