

# Vantage Manual Turbo

- Coal, Pebble, Deluxe Pebble, Log, Driftwood, Modular Coal, Modular Pebble & Ripped Coal Effect
  - Inset Live Fuel Effect Gas Fires with Power Flue
- 



## Installation and Users Instructions

**This product is not suitable for primary heating purposes**

These instructions should be read by the installer before installation and then should be handed to the end user when the installation is complete.

**This is an official requirement and is the responsibility of the fitter of this appliance.**

Having installed the appliance, the installer should take the necessary steps to ensure that the user fully understands how to operate the appliance and is also made aware of the fire's basic cleaning and maintenance requirements.



<b>SECTION</b>	<b>PAGE</b>
Notes for the Installer and End User	3
Installation Requirements	4
Installation Procedure	6
Commissioning	9
Operating Sequence	10
Technical Data	10
Replacement Parts	10
Trouble Shooting (GAS SAFE Engineer Only)	11
Control Panel Wiring Diagram	12
Fault Finding Diagram	13
User Instructions	14
Cleaning and Maintenance	15
Fire Front Specifications	15
Coal Layout Instructions	16
Pebble Layout Instructions	18
Deluxe pebble Layout Instructions	20
Log Layout Instructions	22
Driftwood Layout Instructions	24
Modular Coal Layout Instructions	26
Modular Pebble Layout Instructions	28
Ripped Coal Layout Instructions	30
Guarantee	32
Trouble Shooting (User)	32



## THIS APPLIANCE IS INTENDED FOR DECORATIVE PURPOSES

This appliance has been designed, tested and manufactured to the European Standard EN509 relating to Decorative Gas Appliances and **must** be installed by a qualified GAS SAFE Registered Installer in accordance with the Gas Safety (Installation and use) regulations 1994 and all other relevant standards.

This appliance must be connected in accordance with the National Regulations. The appliance must be sealed into a non-combustible fireplace (Fig. 2).

Before installation, ensure that the local conditions, (identification of gas type and pressure) and the adjustment of the appliance are compatible.

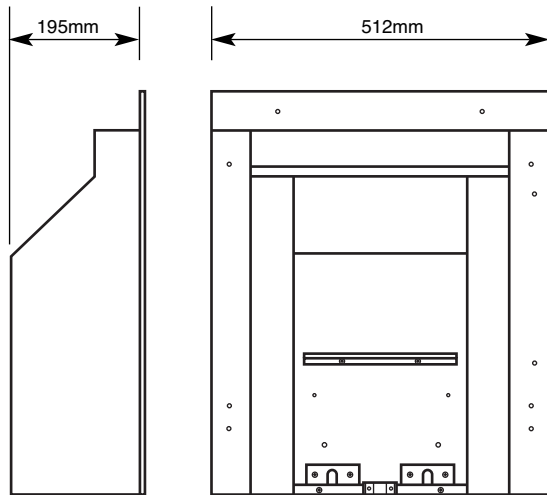

Fig. 1

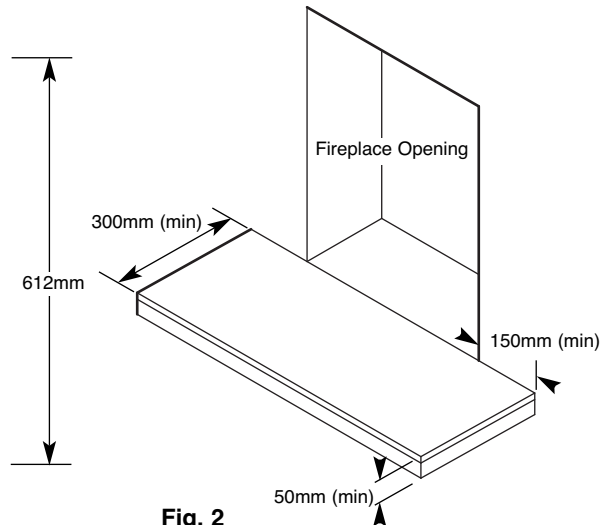

Fig. 2

An air vent is not normally required for this application because its input does not exceed 7kW.

The installer must establish that all the products of combustion are entering the flue within five minutes of lighting from cold. This can be verified by traversing the canopy with a lighted smoke match (see 'Spillage Test' page 5).

An isolation valve must be fitted adjacent to the appliance. When closed, this will allow the complete burner and control assembly to be disconnected for maintenance or repair in accordance with national regulations.

The gas supply should be provided by a semi rigid pipe with an 8mm diameter and should be no longer than 1.5 metres in length.

Prior to installation, ensure that the local distribution conditions (identification of the type of gas and pressure) and the adjustment of the appliance are compatible.

**NOTE:** When the gas supply pipe is passed through masonry or other brickwork always ensure that the end of the pipe is covered to avoid any debris passing through into the appliance controls.

The appliance is fitted with an Oxygen Depletion Sensor (ODS) that monitors the room for products of combustion. If products are detected, the ODS will automatically shut down the appliance. If this situation arises, re-light the appliance, referring to the user instructions (page 14). If shut down re-occurs, a qualified person must be called to thoroughly check the appliance. The spillage monitoring system (ODS pilot) must not be put out of operation or be tampered with or adjusted by either the installer or the user. If the unit is found to be at fault it should be replaced with the manufacturers original replacement parts.

# INSTALLATION REQUIREMENTS



This appliance must only be installed in Great Britain or Ireland.

1. This fire is either a natural gas or LPG appliance and has been designed for use with the following applications:
2. A non-combustible hearth must be provided to comply with current building regulations. Care should be taken to prevent any damage being caused to surrounding soft furnishings or decoration, e.g. many embossed vinyl wall coverings may become discoloured if placed too close to the appliance.
3. A suitable proprietary fire surround with 100°C rating may be used with a minimum clearance from hearth to underside of shelf of 830mm, providing that the depth of shelf is 150mm or less.
4. Where the shelf depth is greater than 150mm, the minimum height clearance should be increased by 25mm increments for each additional 12.5mm of shelf depth.
5. Minimum width between vertical sides of combustible surround should not be less than 800mm provided the appliance is central to the surround and the surround legs do not exceed a 150mm profile.
6. If the 150mm profile is exceeded, the width of the surround (and the back panel) should be increased by 25mm for each additional 12.5mm of profile depth.

## FLUE TERMINAL POSITIONS

The minimum acceptable dimensions from the centre of the flue terminal grille to obstructions and ventilation openings are below (Fig. 3).

Fig. 3

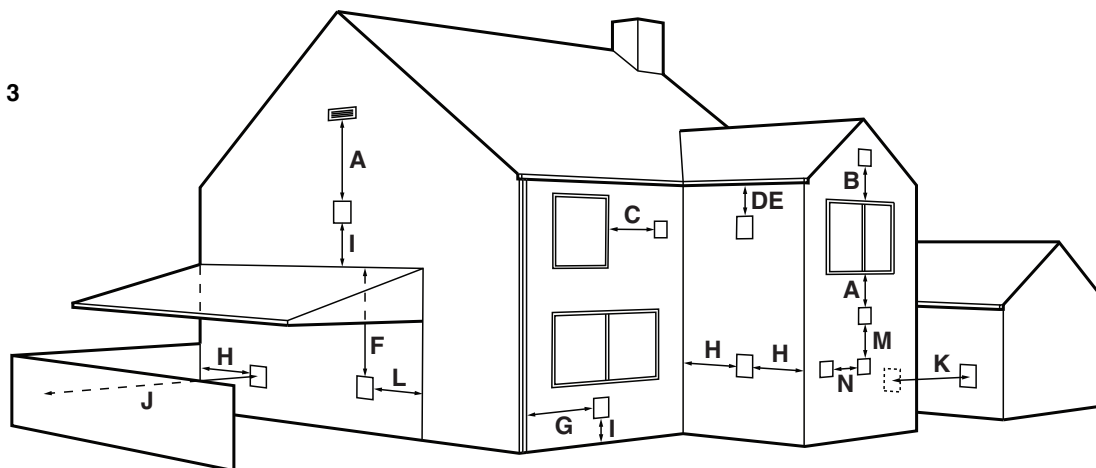

Dimension	Terminal Position	Minimum
A	Directly below an opening, air brick, window etc.	300mm
B	Directly above an opening, air brick, window etc.	300mm
C	Horizontally to an opening, air brick, window etc.	300mm
D	Below gutters, soil pipes or drain pipes	75mm
E	Below eaves	200mm
F	Below balconies or car port roof	200mm
G	From a vertical drain or soil pipe	150mm
H	From an internal or external corner or to a boundary alongside the terminal	200mm
I	Above ground, roof or balcony level	300mm
J	From a surface or boundary facing the terminal	600mm
K	From another terminal facing the terminal	1200mm
L	From an opening in a car port	1200mm
M	Vertically from another terminal on the same wall	1500mm
N	Horizontally from another terminal on the same wall	300mm



### VENTILATION

No special ventilation bricks or vents are required in the room containing the appliance, providing that normal adventitious room ventilation exists. The installer must determine this by carrying out a spillage test.

### SPILLAGE TEST

To check for satisfactory clearance of products of combustion, close all doors and windows and leave the fire burning for five minutes. Insert a lit smoke match on a vertical plane 50mm down, 50mm inside the canopy opening. All the smoke must be drawn into the flue. If spillage occurs, allow a further ten minutes and repeat the test. Should spillage still occur turn the appliance off and seek expert advice.

To continue the test: If an extractor fan is situated in the room the test should be repeated with the fan running. If there is a connecting room with an extractor fan the test should be repeated with all the doors to that room open and the extractor fan running.

### INSTALLATION INTO TIMBER FRAMED DWELLINGS

Where removal of any part of the inner timber leaf of the wall is involved, the structural integrity of the wall must be maintained and the advice of your local Building Control Department should be sought. If the property is under any N.H.B.C. cover, it is advised that their advice on this modification should also be sought.

Standard methods of installation may be adapted for use in timber framed buildings, providing extra care is taken to prevent combustible materials from contact with hot surfaces.

The appliance must be installed in accordance with British Gas documents DM2 and DM3 or the Institute of Gas Engineers published procedure IGE/UP/7.

Special attention must be paid to the location of the studwork frame of the inner leaf and the appliance positioned accordingly. Wires and pipes that run within the inner timber leaf must also be located and taken into account when positioning the appliance.

### INSTALLATION USING EXTENDED FIRE SURROUND OR FALSE CHIMNEY BREAST

When using this method of installation the following amendments should be incorporated. 25mm clearance must be allowed from the appliance firebox to any insulated combustibles. 75mm clearance must be allowed to any unprotected combustibles.

50mm minimum thickness of insulation should be provided around the flue pipe and gather hood. Where the flue pipe passes through the inner leaf, a hole 100mm larger than the flue should be cut to allow a 50mm air gap around the entire flue circumference. The vapour barrier on the back of the inner leaf should be cut and carefully fixed to prevent any ingress of damp into the plasterboard layer. A layer of insulation will need to be provided to insulate the surface of the inner wall from the heat effect of the flue. It may be advantageous to use a sheet of Superlux board for this purpose. When setting the appliance into the inner wall find a suitable position between the wall panel frames and carefully open up a hole to the dimensions given in the relevant section. Pay careful attention to securing the damp proof membrane back into position. A Drip collar of galvanised or stainless steel should be formed with the twisted joint on the underside of the flue to disperse drips. An air gap of 75mm between all hot surfaces and the surrounding wall should be allowed, if protective insulation is used this may be reduced to 25mm clearance.

The exposed cavity should be sealed off using Superlux or a similar non-combustible board. The board should be fixed at an angle, lower at the back so as to direct any moisture coming down to the outside wall. This board should be fixed with screws, Unibond, or a similar adhesive. It is important to fit this board or a cavity tray to protect the property and the appliance from drips of water. The sides of the opening where the cavity is exposed should be packed with Rockwool or similar non-combustible material to a minimum depth of 50mm. The Rockwool packing must extend from the base of the opening to the Superlux board.

### NOTES ON ELECTRICAL INSTALLATION

1. External wiring must be correctly earthed, polarised and in accordance with relevant regulations/rules. In GB this is the current I.E.E. Wiring Regulations. In IE reference should be made to the current edition of ETCI rules.
2. The method of connection to the electricity supply must facilitate complete electrical isolation of the appliance.
3. Connection may be via a fused double-pole isolator with a contact separation of at least 3mm in all poles. The appliance must be positioned so that the switch is accessible.
4. If the appliance is to be fitted with a plug, the appliance must be positioned so that the plug is accessible.
5. **THE WIRES FEEDING THE FAN BOX MUST NOT BE ALLOWED TO TOUCH THE REAR OF THE FIRE BOX**



## INSTALLATION OF THE FIRE BOX

1. With the fire place fixed on a suitable outside wall, screed the recess to the level of the hearth. This ensures accurate fitting of the fire and flue spigot alignment with the fan unit.

2. **From Inside:** Draw a vertical line centrally on the back wall of the fireplace opening. Measure 402mm up from the hearth and place a mark on the line. With a suitable drill (approx 10mm) make a hole through to outside ensuring the drill is kept level.

**From Outside:** Draw a rectangle 230mm wide x 270mm high centrally above the centre of the drilled hole.

**Note: To successfully install this system, the bottom edge of the wall plate must be at least 3" (75mm) from the outside ground level.**

Fig. 4

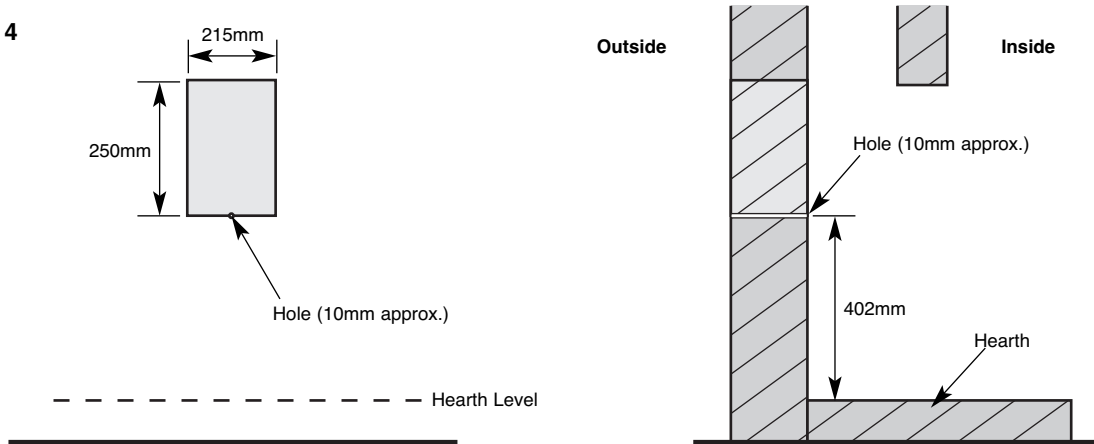

3. Carefully lift the appliance out of the packaging taking care not to damage the ceramic components in the separate carton.

4. Remove the magnetic trim and store to one side to prevent any damage.

5. Cut the foam sealing strip (in plastic bag supplied) to length and stick a continuous strip down the two sides and across the top of the radiant box. When the box is placed against a flat surface the foam strip will form a seal around the boxes flange.

6. Insulate the rear of the fire box with Rockwool or similar.

7. Carefully lift the appliance into position in the fireplace opening and check that the flange of the radiant box fits flush against the sealing face with no gaps present.

8. Remove the four screws that secure the burner tray to the box, two on the front leg and two at the rear of the tray. Remove the burner tray and place to one side (Fig. 4).

Fig. 5

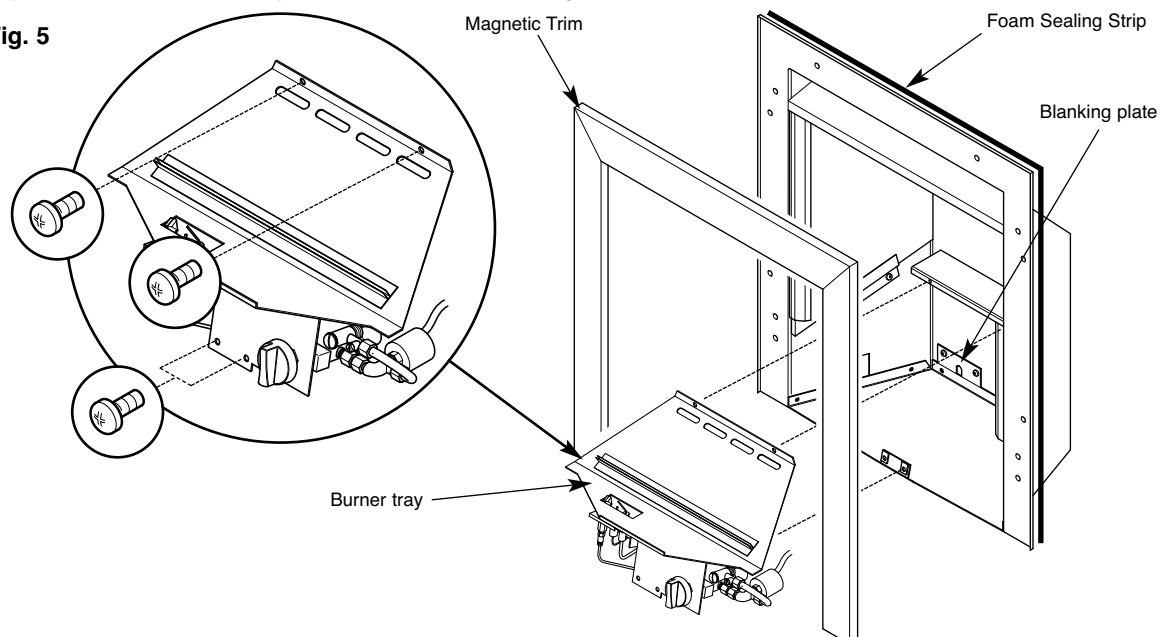



9. With the radiant box placed in the opening, mark out four of the eight fixing holes. Remove the box and carefully drill and fit rawl plugs.

10. Temporarily fix the flue spigot to the rear of the radiant box with the the four self tapping screws provided. Offer the radiant box with the spigot attached into the fireplace opening. (carefully tuck or clip the cables over to the left hand side of the opening, ensuring that they do not come into contact with the fire box). The spigot should protrude through the outer hole in the brickwork. Screw the radiant box to the back panel.

11. Take off the outer fan box cover by removing the single screw near the flue outlet and swinging the cover upwards to disengage on the mounting rail. To remove the fan unit, unscrew and remove the lower two screws and partially unscrew the top screws. The unit can now be lifted off the two rear screws via the keyhole slots.

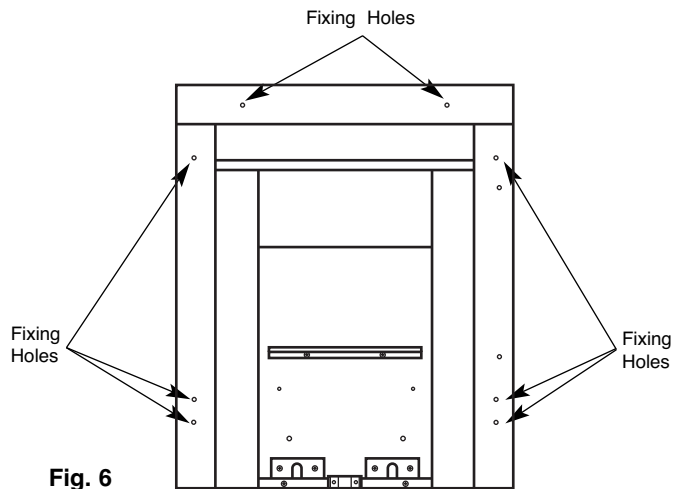

**Fig. 6**

12. From the outside, position the fan box into the cut out of the brickwork and over the protruding spigot ensuring that the fan box flanges are flat against the brickwork. Mark the flue spigot so that it would be just below 'flush' with the face of the fan box (on final fix the spigot should not touch any part of the fan unit as this can cause a vibration noise). Remove the radiant box and cut the spigot to length.

**Fig. 7**

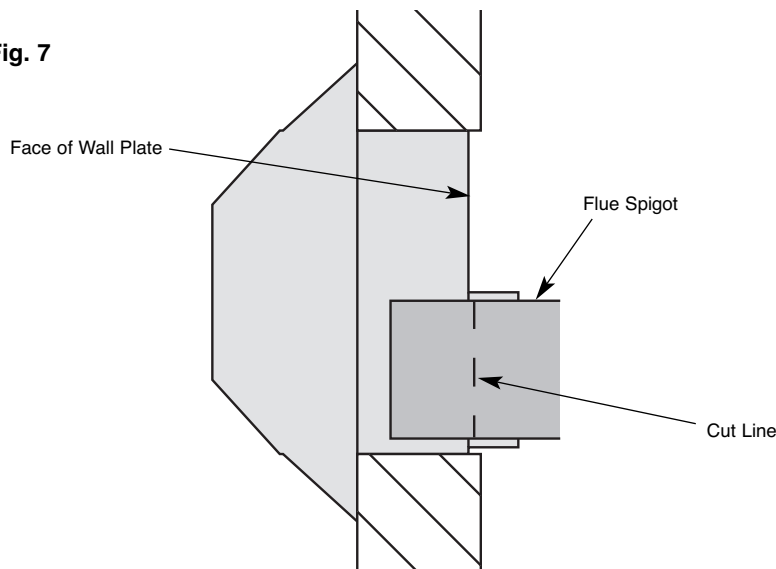

13. Having cut the spigot to length, the radiant box should be offered up to the fireplace opening for the final fix. Before fixing, the power cable should be fed round the back of the fireplace to a wall mounted power source. This can be a three pin plug fused 3amp or by a fixed connection to a 3amp, all pole switched fused spur. The spur must have a contact separation of at least 3mm. The ten core cable with the two six way connector plugs should be temporarily fed through the flue spigot. The radiant box can now be screwed securely to the back panel.

**INSTALLING THE FAN UNIT**

**Warning - This Appliance MUST Be Earthed**

1. Take the wall plate and place into the outside hole and over the cut to length spigot making sure that the inner and outer spigots line up with each other centrally.

**Make sure that the cable entry hole is in the top right hand corner (as the fan will only fit one way round)**



Fig. 8

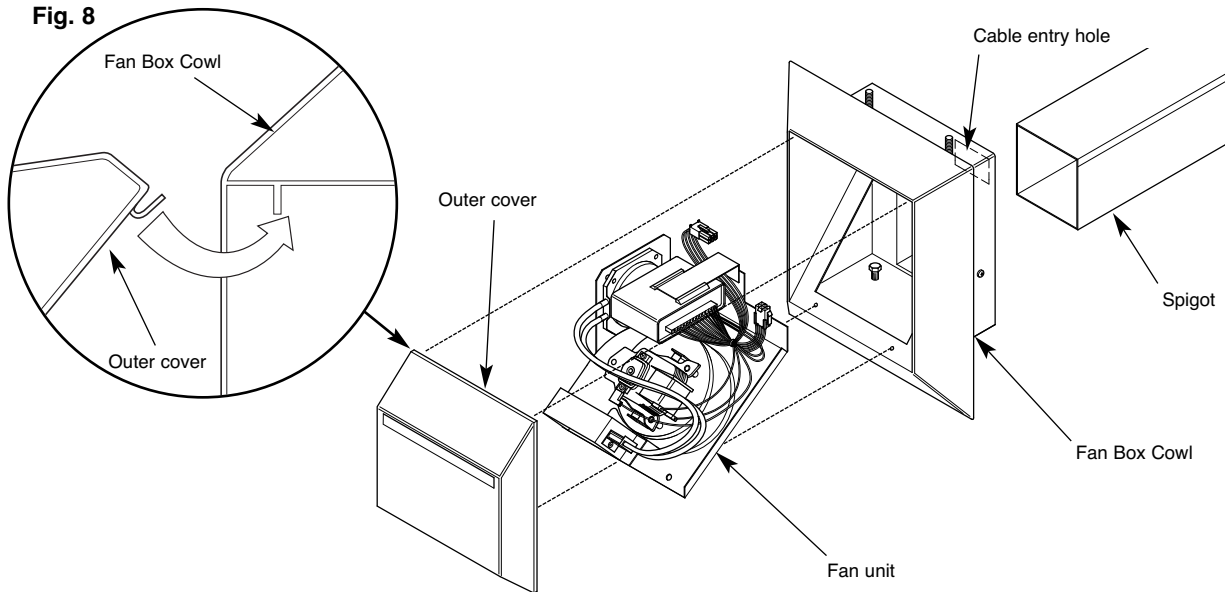

2. Working from inside the fan box, remove the cable retaining plate by unscrewing the two screws in the upper lefthand corner. Feed the ten core wire through the rectangular cable hole. Secure the cable glands to the retaining plate, leaving approximately 6" of cable from the connectors to the plate. Secure the retaining plate into position using the two screws.

3. Slide the fan box into the wall. Making sure the outer cowl of the fan box is touching the wall all round, secure the fan box into position using the four clamping bolts. Adjust the bolts so that the fan box sits centrally with the flue. If the bolts cannot clamp to the brick (due to the design of brick) use the two packing pieces provided. Use the silicone provided to seal the top and side edges of the fan box cowl to the wall.

Fig. 9

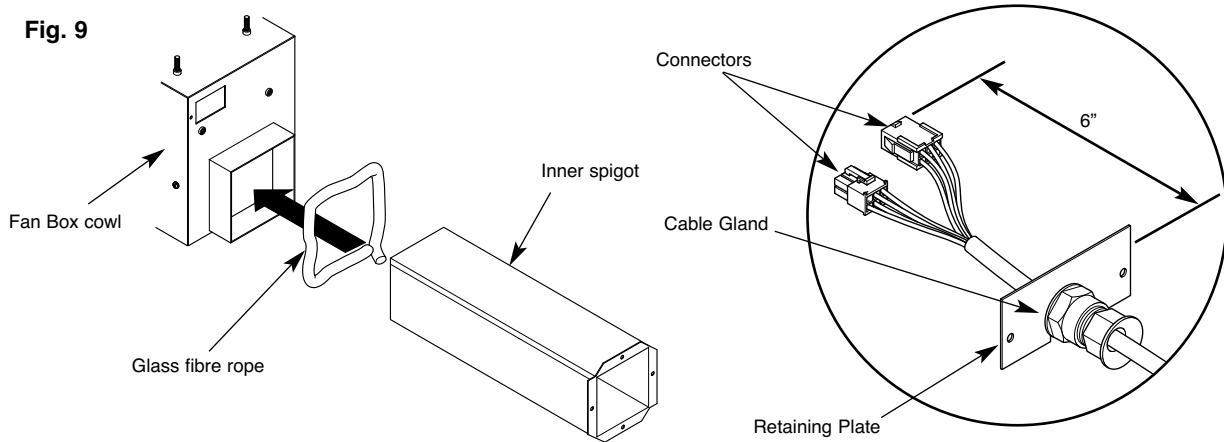

4. Feed the glass fibre rope gently into the gap between the inner and outer spigot to form a ring seal between them. The rope can be pushed into the gap with a large flat bladed screwdriver. Care must be taken not to push the rope too far, as it may fall into the cavity (it only needs to be inserted enough to form a seal between the mating spigots).

5. Replace the fan unit by hooking the keyhole slots over the heads of the top mounting screws. Replace the two lower screws and tighten the upper two.

6. Connect the two six way plugs from the PCB and fan wiring loom to the plugs on the ten core wire.

7. Replace the cover panel by engaging it's top channel into the mounting rail in the fan box. Swing the cover downwards and secure with the retaining screw (Fig. 8).

**PLEASE NOTE: Silicone sealant should be used to seal round the top and two sides of the Fan Box Cowl only.**

**NOTE: THE FITTER WILL BE HELD RESPONSIBLE AND WILL BE LIABLE TO REFUND THE REPLACEMENT, IF THE UNIT IS NOT SEALED CORRECTLY.**





8. Position the burner tray into the box in order to determine the length of 8mm gas supply needed and cut to length.

9. Before making the final connection, thoroughly purge the supply pipe to clear any foreign matter, i.e. masonry dust etc, as this could lead to blockages in the control valve and/or pilot assemblies.

10. Fix the burner in place using the four screws and make the gas connection.

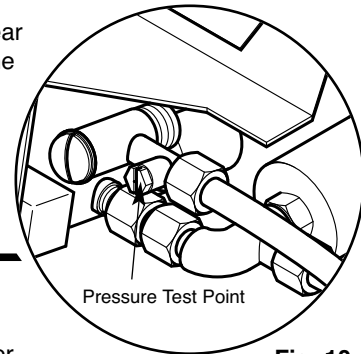

**Fig. 10**

**COMMISSIONING**

1. Carry out a gas soundness test.
2. Unscrew the pressure test point sealing screw (Fig. 10) and fit a manometer. Consult the user instructions (page 14). Ignite the appliance and turn to the high position.
3. Take a pressure reading and consult the technical data (page 11) to establish the correct working pressure.
4. Once the pressure has been checked and verified, turn off the appliance. Consult the ceramic component set up diagrams (page 16 - 31) and fit the ceramics as per the instructions.
5. Carry out a Spillage Test (see page 5).

**ALTERNATIVE FIXING METHOD**

Where the drilling of the back panel is not practical, an alternative fixing method may be employed using the cable fixing kit provided. Drill four holes in the rear of the fireplace opening (Fig. 11). Securely fix the four eye bolts provided using suitable rawl plugs. Feed one cable through each of the top holes in the rear of the fire box.

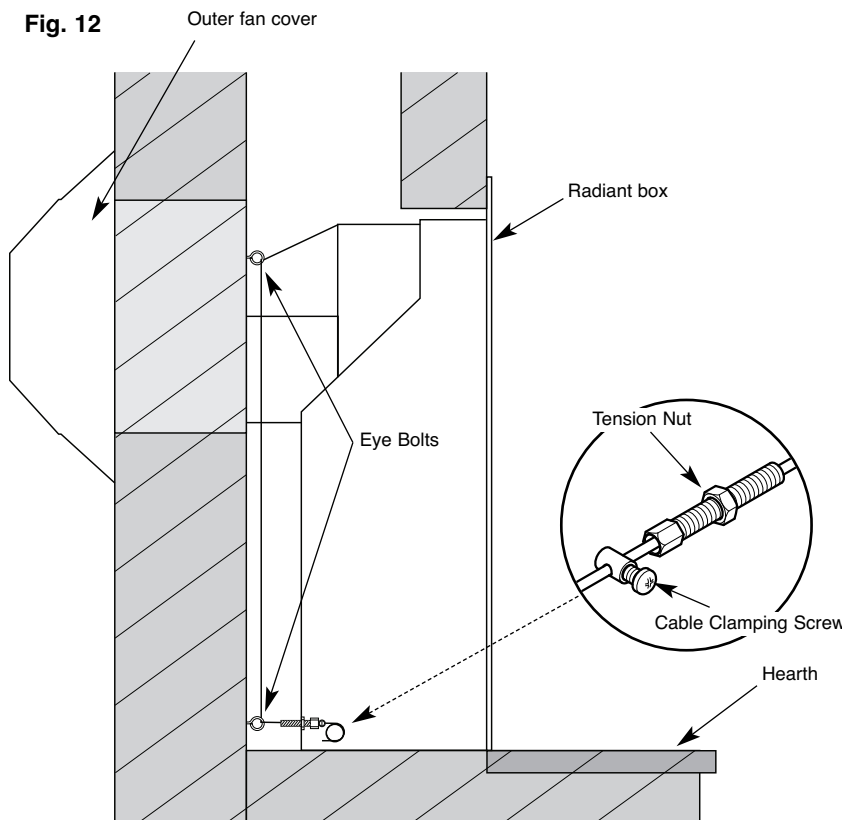

**Fig. 12**

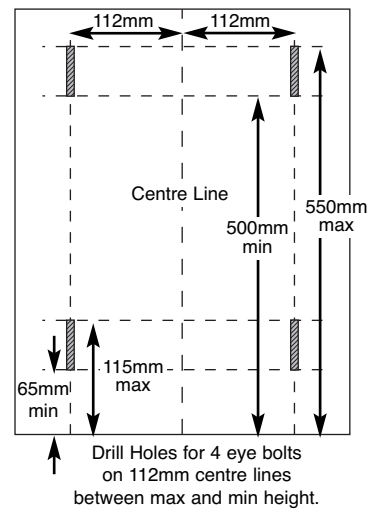

**Fig. 11**

Fix the radiant box into the opening, securing into position using the cable fixing kit (Fig. 12). Do not cut off the loose ends as the full length is required should the radiant box need refitting at any time. Coil up and securely store underneath the burner tray.

## OPERATING SEQUENCE



This system is basically an add on to an existing manual fire. The fan proving unit operates in such a way that when the fan is running and all the safety features are checked OK, then it opens a solenoid up stream of the gas valve to allow gas to the manually operated gas valve.

Sequence: Initially with the unit in it's off state, the gas valve relay contacts are open circuit and the fan is off. To activate the unit, the user depresses the ON switch, at this point the APS is checked. If this indicates that fan pressure is already present, no further action will occur and when the user releases the ON switch, the unit will be in it's off state.

If the APS indicates no airflow, then the fan will be switched on at it's high rate. Once the unit is in this state, it will then wait until the APS ON contacts are made.

Once air pressure has been established, the fan will be switched to it's service speed. After a delay, the gas valve relay will be activated allowing a current to energise the solenoid valve so that gas can flow to the manually operated gas valve. At this point a green neon will be illuminated.

Manual ignition can now take place.

If during running, the APS signals air flow failure, then the unit will switch back to high speed. If the ON contact is not made in the APS, then the unit will switch off after a period of 6 seconds. In it's off state, the gas valve relay contacts are opened and the gas solenoid is closed. The fan is switched off and the neon will be extinguished. Ignition will not be started unless the fan is switched back on manually.

At any time the user can press the off switch, this will cause the fan to shut down in the same manner as described above.

## TECHNICAL DATA

Gas Type	Natural Gas (G20) Cat I <sub>2H</sub>	LPG (G31) Cat I <sub>3P</sub>	
Gas Connection	8mm	8mm	
Number of Injectors	One	One	
Injector size	Stereomatic 074	Stereomatic 110	
Control Max Operating Temperature	80°C	80°C	
Inlet Pressure Cold	20 mbar	37 mbar	
Heat Input (Gross)	6.9 kW	5.1 kW	
Weight	13 kg	13 kg	
230V ac	50Hz	55W	Fuse Rating 3A IPX4D

## REPLACEMENT PARTS

1. **Loose coals** - The ceramic coals supplied with this appliance can be replaced at service intervals depending on their condition. If the coals do require replacement, the consumer can do so provided that the Ceramic Component Layout Instructions (pages 16 - 31) are adhered to. Under no circumstances should additional/extra coals be added. Only genuine Legend replacement parts should be used.

Order Ref: **VLC06**

2. **Front Coal, and Fuel Bed, Side Cheeks and Rear Coal** - All these ceramic components can be replaced at service intervals depending on their condition. If the coals do require replacement, the consumer can do so provided that the Ceramic Component Layout Instructions (pages 16 - 31) are adhered to. Only genuine Legend replacement parts should be used.

Order Ref: **VFC02, VFM03, VCSC04, VCR05**

3. **Oxygen Depletion Sensing Pilot** - In the unlikely event of a pilot failure, the pilot assembly should only be replaced by a **GAS SAFE Registered Engineer**. The user must not carry out this work.

Order Ref: **NG - LEG01, LPG - LEG26**

4. **Control Tap** - In the unlikely event of control tap failure, the assembly should only be replaced by a **GAS SAFE Registered Engineer**. The user must not carry out this work.

Order Ref: **NG - LEG02, LPG - LEG30**

5. If the supply cord is damaged, it must be replaced by a new harness assembly from the manufacturer or service agent. Order Ref: **LEG35**



## 1. The Piezo will not spark.

Check: If the electrode is cracked or broken - Replace pilot assembly.  
 If the HT lead is shorting out on the burner body - Locate where the short is occurring, isolate and/or re-route the lead.  
 If the HT unit/lead is faulty - Replace as necessary.

## 2. The Pilot will not light (but the Piezo is sparking).

Check: If the gas is reaching the pilot - check joints and connections.  
 If the pilot jet is blocked - Inspect and clean.  
 If the pilot is still not passing gas - Replace the pilot assembly.

## 3. The Pilot lights but goes out when the control knob is released.

Check: If the Thermocouple is loose/disconnected at the control valve - remake the connection.  
 If the Thermocouple is faulty - Replace.  
 If the Electro magnetic valve is faulty - replace valve.

## 4. The Burner will not light readily from the pilot.

Check: If the coals are obstructing the pilot to burner path ie. Are the coals blocking the opportunity for the pilot to light the burner - Relay the coal set as per Ceramic Component Layout Instructions. (pages 16 - 31).

## 5. The fire makes a roaring noise when lit.

Check: That the front coal is seated correctly and the pilot hole is positioned correctly over the pilot assembly.

**IF ANY PART OF THE PILOT ASSEMBLY IS SUSPECTED AS BEING FAULTY THE COMPONENT MUST BE REPLACED.**

## 6. The flames appear blue (after the fire has fully warmed up). The coals/ceramic liners have soot deposits.

Check: That the coals have not moved from the original setting - Relay the coals as per the Ceramic Component Layout Instructions (pages 16 - 31).  
 There may be too little/much ventilation into the room. Identify and then take steps to rectify.

## 7. The flame picture is low on the high setting.

Check: For any partial blockages - Check all obvious locations for debris in pipe work and fittings.  
 Inlet gas pressure, both standing and working gas pressure - Identify problem and take necessary steps to rectify. **Note:** Flame pattern improves with use.

## 8. Fumes enter the room when the fire is operating.

Check: Why the fan is not drawing all the products of combustion to outside, identify where the problem lies and rectify, otherwise disconnect the fire and seek professional guidance.

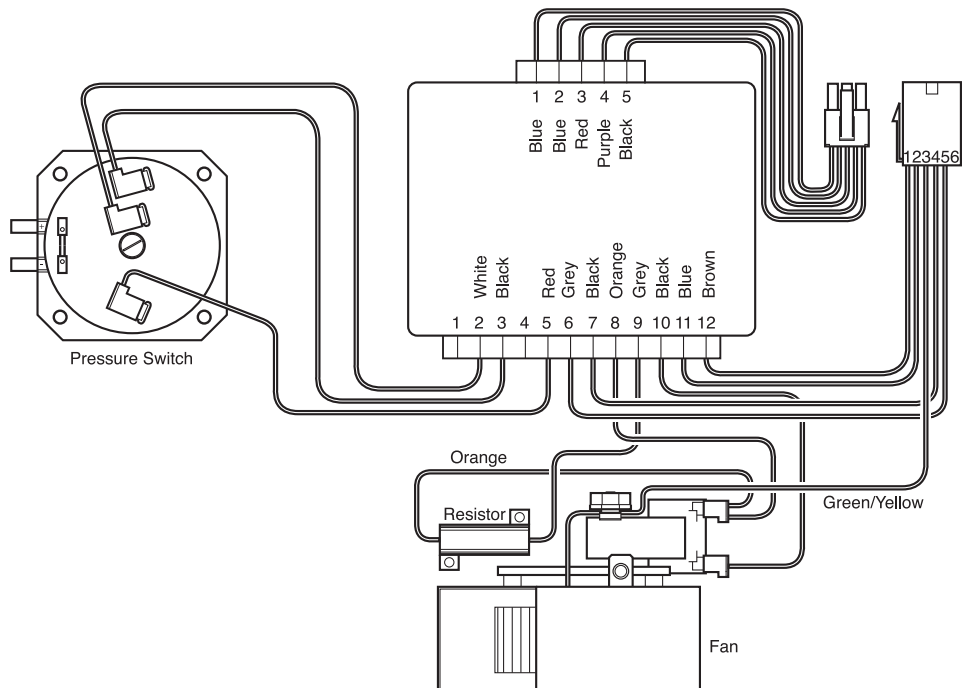

# CONTROL PANEL WIRING DIAGRAM

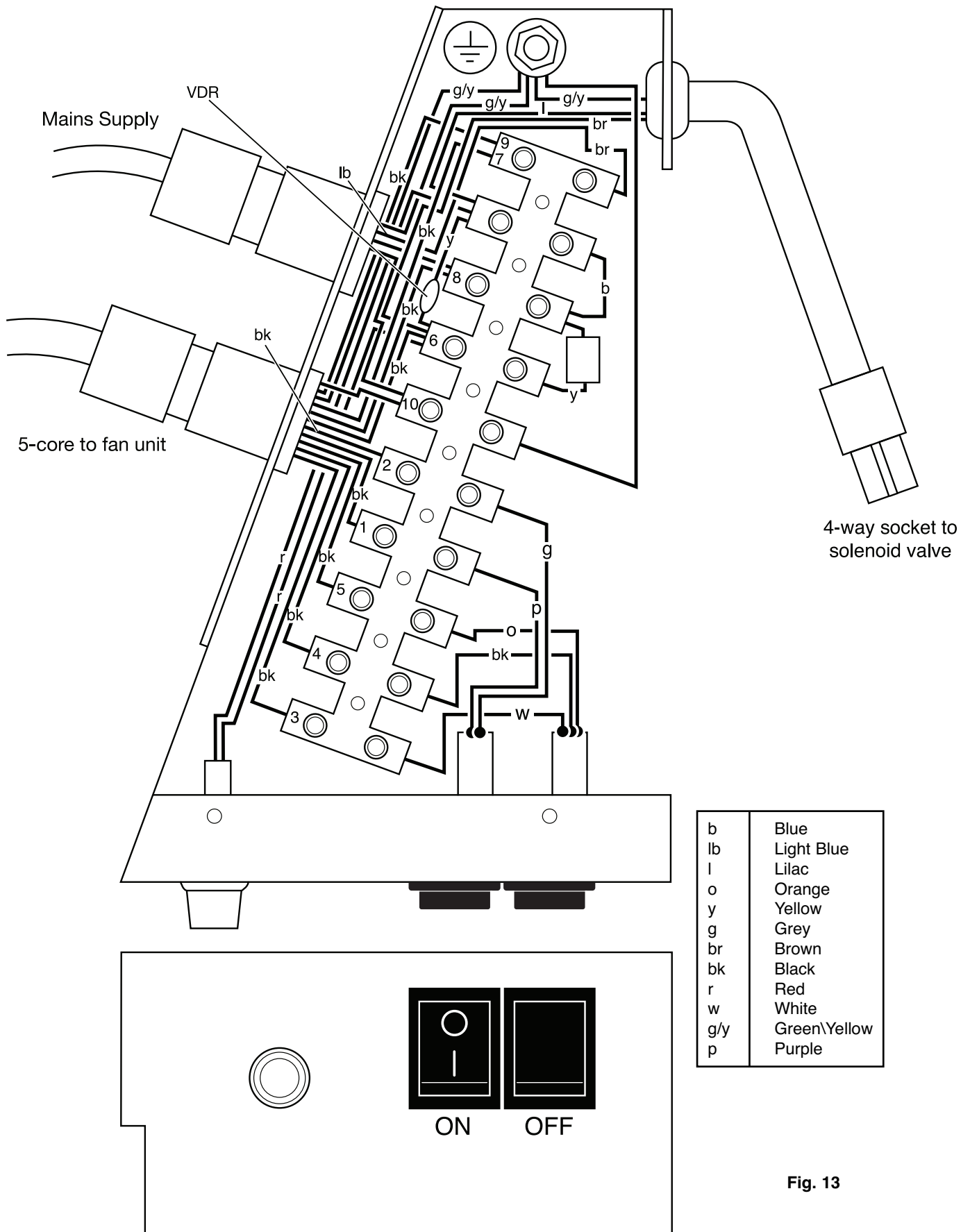
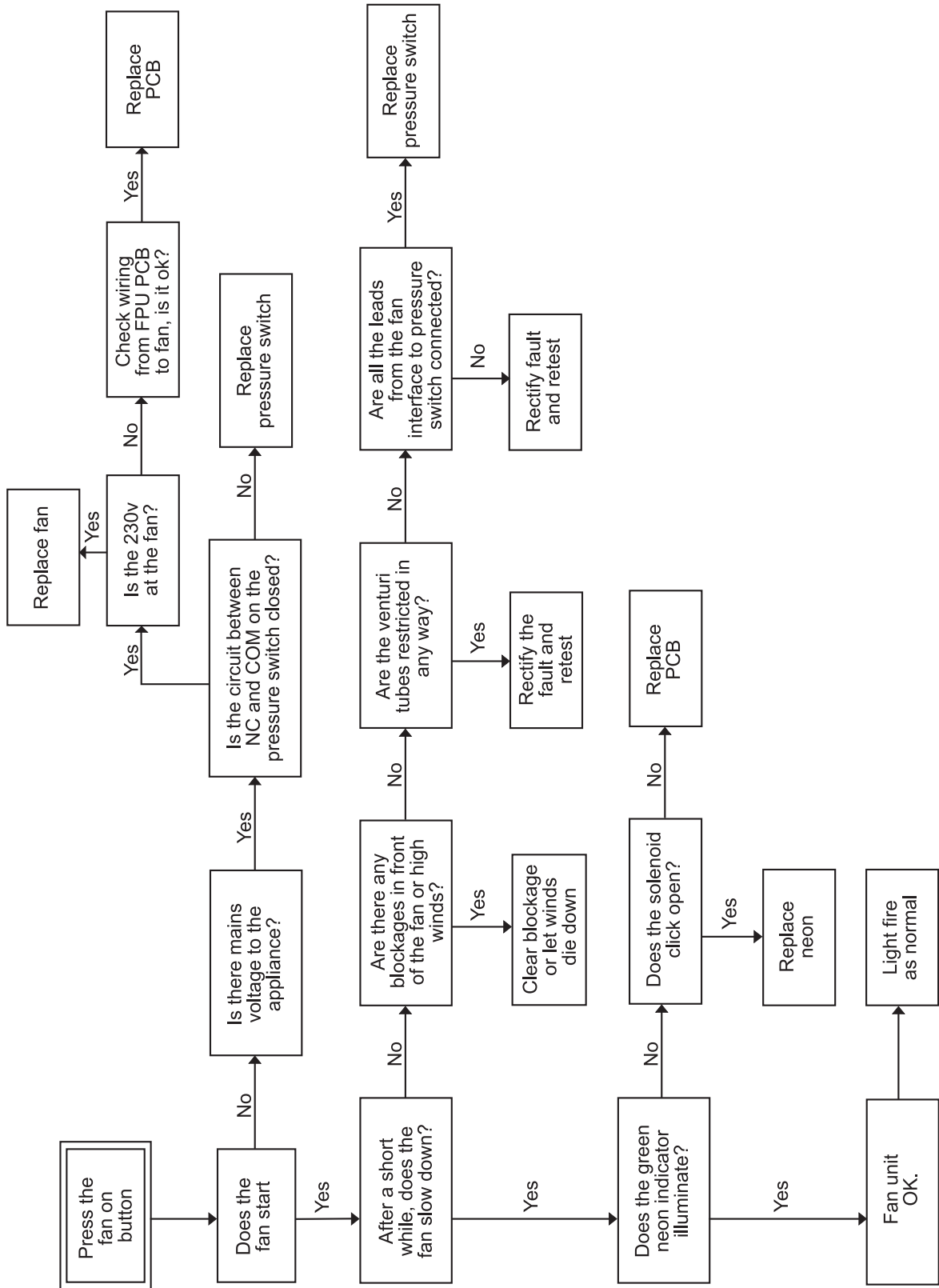

Fig. 13





**THIS APPLIANCE IS INTENDED FOR DECORATIVE PURPOSES.**

Please also familiarise yourself with the **Notes for the Installer and End User** on page 4.

## OPERATION AND CONTROLS

It is most important that the operator of this gas appliance has fully read and understood all the operating, cleaning and maintenance procedures as laid out in these instructions.

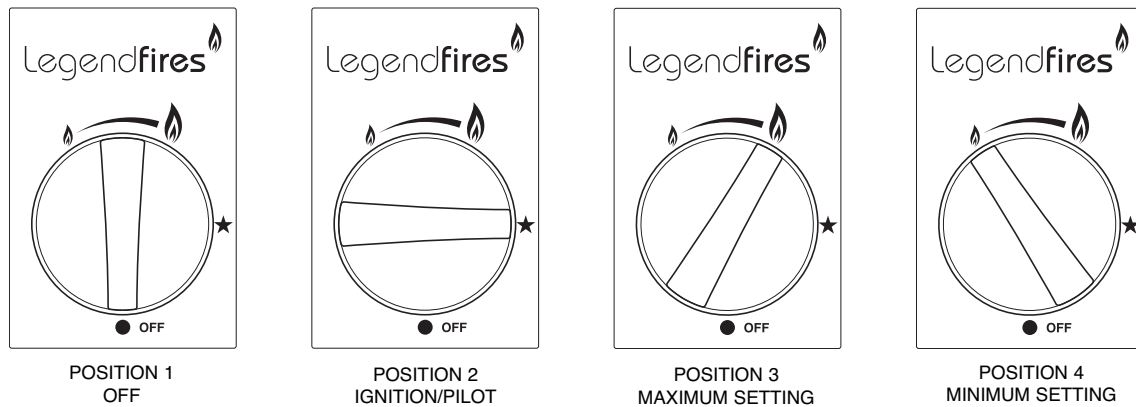

**Fig. 14**

### Lighting Procedure

1. To light the fire, remove the ash pan cover.

2. To switch on the appliance, first turn the mains electricity supply on at the fused spur or switched plug. Switch on the fan by keeping the ON switch pressed until the green neon GAS ON indicator illuminates. Gas is now available at the burner.

3. Control knob to be in POSITION 1 at commencement of the ignition sequence.

4. Fully depress control knob and turn anticlockwise to POSITION 2 where it reaches a natural restriction (allow a couple of seconds for the pilot gas to purge through the pipe). A sparking click is heard/felt and the pilot flame is then lit. The pilot assembly is located at the front lefthand side of the fire, and when ignited (this can take two or three 'clicks') it can be seen through the front coal set. Keep the knob depressed for 10/15 seconds to allow the thermocouple to establish the pilot flame. The knob can then be released.

5. The operating level of the burner is now set by turning the control knob from the pilot POSITION 2 through the maximum setting POSITION 3 to the minimum POSITION 4. The control knob is adjustable between these two positions.

6. To turn off the appliance, depress the control knob and turn clockwise until the POSITION 2 is reached. The main burner will go out but the pilot light will still be lit. The pilot can then be extinguished by depressing the control knob and then turning to the off POSITION 1. To turn off the fan simply press the FAN OFF switch.

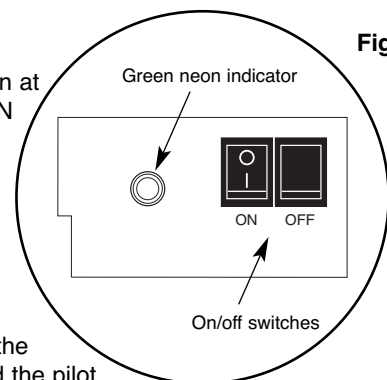

**Fig. 15**

### WARNINGS:

**Never throw rubbish on, or otherwise disturb the fuel bed.  
Any alteration to this appliance including its ceramic components may render it inoperable and unsafe.**

## CLEANING AND MAINTENANCE



Legend Gas Fires recommend that this appliance is serviced at regular 12 monthly intervals. The chimney or flue should also be checked regularly to ensure that all products of combustion are entering the flue and there is no excessive build up of soot.

It is the users responsibility to ensure that the appliance is kept in a clean serviceable condition.

1. **Ceramic Components and Fuel Bed** - Debris from any source should be removed with a soft brush. Please ensure that any debris including soot deposits are removed from the appliance and not left on the fuel bed. It is recommended that the user should, on a regular quarterly basis, carefully remove all ceramic components and thoroughly clean the stainless steel burner strip and the pilot assembly. Any build up of debris in this area could affect the operation of the appliance.

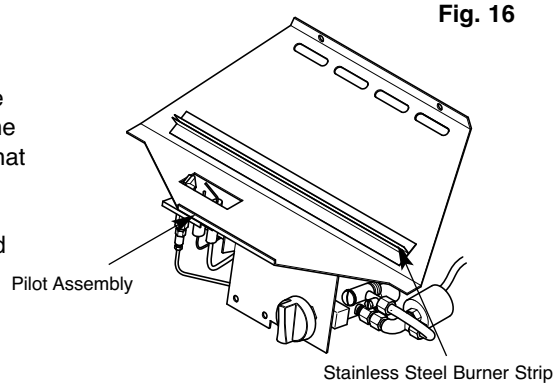

**NOTE:** It is common to find surface cracks in the ceramic components. This is due to the expansion and contraction of the ceramic fibres caused by the intense heat that the burner generates. The cracks will not affect the safe operation of this appliance. However great care must be taken when handling the ceramic components as they will break if handled incorrectly. Do not use a vacuum cleaner to clean the ceramics.

2. **Radiant Box Ceramic Liners** - Use only a soft brush to remove any soot deposits from the ceramic liners during cleaning as this is the only method that can be used to remove deposits. The ceramic liners are very delicate and should be treated accordingly.

3. **Brass Trims and Frets** - The brass trim and fret should be removed from the appliance for cleaning, please ensure that the appliance has cooled thoroughly. Polished metal trims and frets are not lacquer coated and therefore require polishing. It is recommended that a good quality metal polish is used.

4. **Fan** - Remove any household fibres or soot build-up from the blades of the fan with a suitable brush.

## FIRE FRONT SPECIFICATIONS

Fire fronts are now available in many different designs and finishes. The user can now choose their own particular style of fire front to suit their individual fireplace setting, providing the fire front complies with the following dimensions -

Fire Front -	(X) Max: 210mm	Min: 190mm
Ash Pan Cover -	(W) Max: 90mm	Min: 65mm
	(Y) Max: 345mm	Min: 320mm

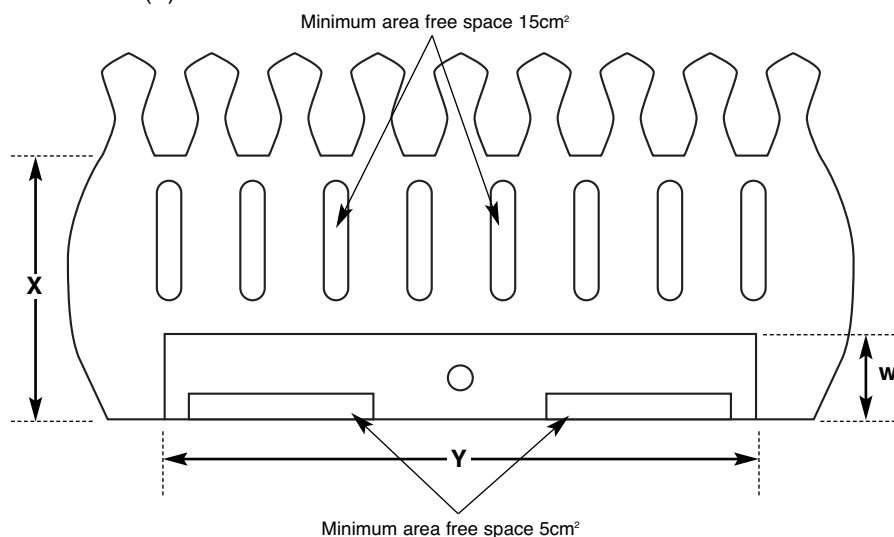

**SAFETY WARNING** - This appliance has a naked flame and as with all heating appliances a fireguard should be used for the protection of children, the elderly and infirm. Fireguards should conform to BS 6539 (1984 Fireguards for use with solid fuel appliances). This fire is not fitted with an integral guard. In normal use consideration may be given to the use of a fireguard conforming to BS 6539, such that the approach to the naked flame is minimised.

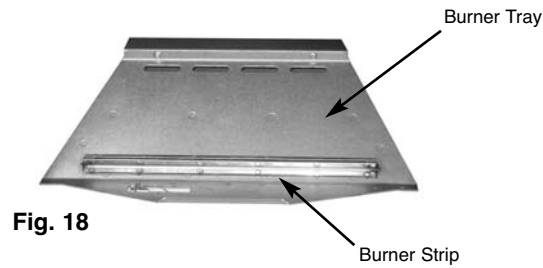

Fig. 18

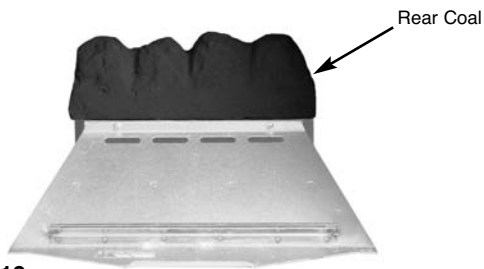

Fig. 19

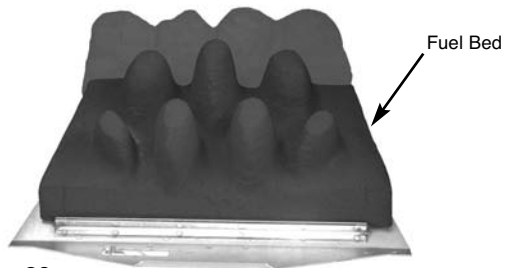

Fig. 20

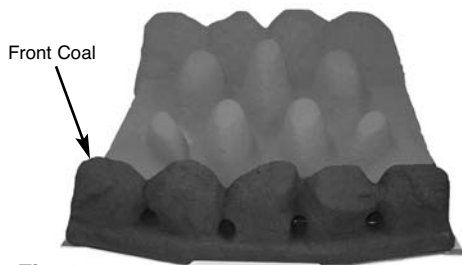

Fig. 21

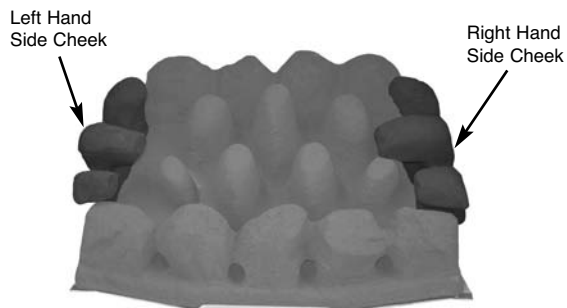

Fig. 22

**It is very important that all the coals are used and arranged as shown in order to achieve the desired flame picture.**

It may be necessary to remove some or all of the coals to clean them at some time. Cleaning must only be done using a soft brush.

**CAUTION:** The coals are extremely fragile and must be handled accordingly. Gloves should be worn and any inhalation of dust should be avoided. The coals must be kept away from children at all times. Never put additional coals on the fire. Never use coals other than those originally supplied, or genuine Legend Spare Parts.

1. Place the rear coal on the rear coal retainer ledge in a central position (Fig. 19).

2. Place the main fuel bed on to the middle section of the metal burner tray. It is important that the front edge of the fuel bed is located behind the burner strip (Fig. 20).

3. Position the front coal on the front coal retainer, making sure that the back edge is pushed up against the front of the burner strip (Fig. 21).

4. Place the side cheeks into position, making sure they are positioned either side of the fuel bed and the overhang is at the front. The outside edge should be in contact with the radiant box ceramic liner. Ensure that the lower part of the side cheeks sit on the front coal and are in front of the rear coal (Fig. 22).



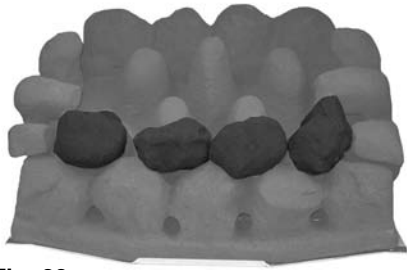

Fig. 23



Fig. 24

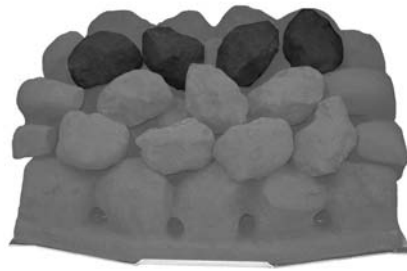

Fig. 25

5. Pick out the smallest two coals and lay to one side, lay the first row of four loose coals on top of the front coal. Ensure the back of the coals are resting on the coal bed and there are even gaps all round (Fig. 23).

6. Choose three loose coals and place them in line on the next row up, again making sure all the gaps are even. It is important that the coals 'bridge' the peaks of the fuel bed and are not placed in between. This helps the flow of burnt gases and should give an even glowing fuel bed (Fig. 24).

7. Lay another row of four coals on the next row up, again making sure all the gaps are even (Fig. 25).

8. Place the next three coals in the middle, on the back edge of the coals previously laid ensuring even gaps all round. Finally place the two small coals, one in each top corner. Make any adjustments necessary to achieve even gaps as this will help in giving a well balanced flame picture and an even glow (Fig. 26).

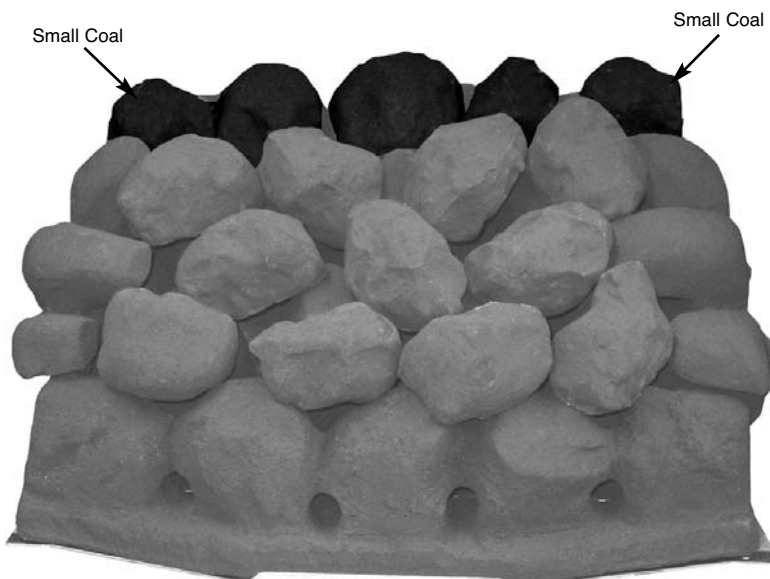

Fig. 26

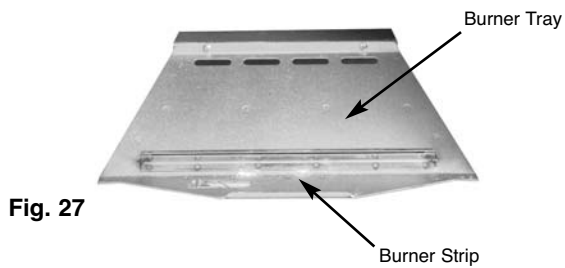

Fig. 27

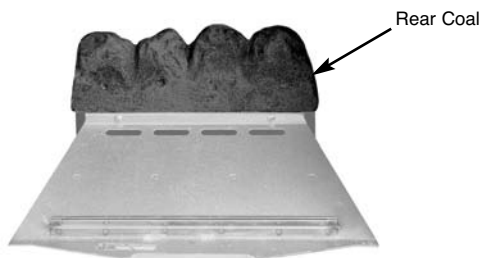

Fig. 28

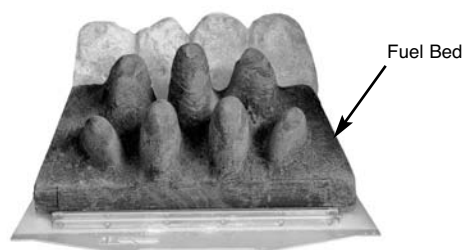

Fig. 29

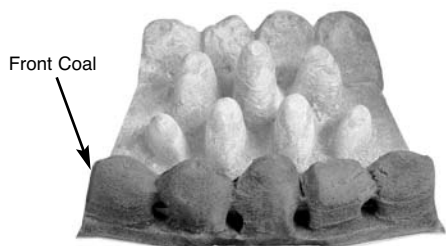

Fig. 30



Fig. 31

**It is very important that all the pebbles are used and arranged as shown in order to achieve the desired flame picture.**

It may be necessary to remove some or all of the pebbles to clean them at some time. Cleaning must only be done using a soft brush.

**CAUTION:** The pebbles are extremely fragile and must be handled accordingly. Gloves should be worn and any inhalation of dust should be avoided. The pebbles must be kept away from children at all times. Never put additional pebbles on the fire. Never use pebbles other than those originally supplied, or genuine Legend Spare Parts.

1. Place the rear coal on the rear coal retainer ledge in a central position (Fig. 28).

2. Place the main fuel bed on to the middle section of the metal burner tray. It is important that the front edge of the fuel bed is located behind the burner strip (Fig. 29).

3. Position the front coal on the front coal retainer, making sure that the back edge is pushed up against the front of the burner strip (Fig. 30).

4. Place the side cheeks into position, making sure they are positioned either side of the fuel bed and the overhang is at the front. The outside edge should be in contact with the radiant box ceramic liner. Ensure that the lower part of the side cheeks sit on the front coal and are in front of the rear coal (Fig. 31).

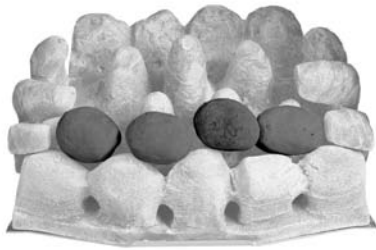

Fig. 32



Fig. 33



Fig. 34

5. Pick out the smallest two pebbles and lay to one side, lay the first row of four loose pebbles on top of the front coal. Ensure the back of the pebbles are resting on the fuel bed and there are even gaps all round (Fig. 32).

6. Choose three loose pebbles and place them in line on the next row up, again making sure all the gaps are even. It is important that the pebbles 'bridge' the peaks of the fuel bed and are not placed in between. This helps the flow of burnt gases and should give an even glowing fuel bed (Fig. 33).

7. Lay another row of four pebbles on the next row up, again making sure all the gaps are even (Fig. 34).

8. Place the next three pebbles in the middle, on the back edge of the pebbles previously laid ensuring even gaps all round. Finally place the two small pebbles, one in each top corner. Make any adjustments necessary to achieve even gaps as this will help in giving a well balanced flame picture and an even glow (Fig. 35).

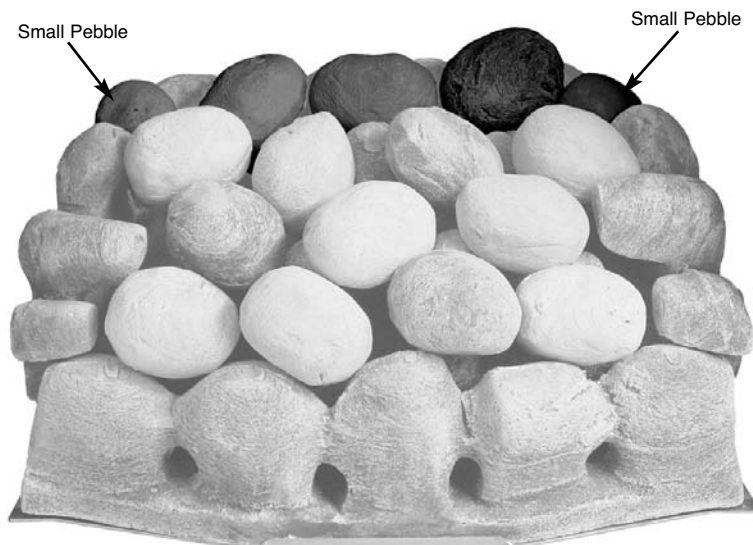

Fig. 35

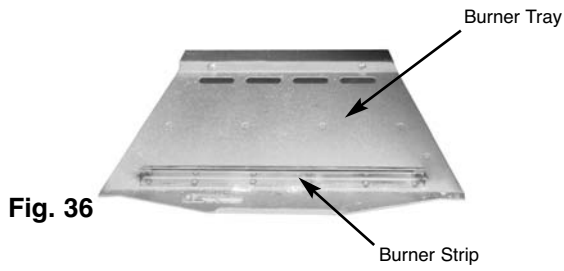

Fig. 36

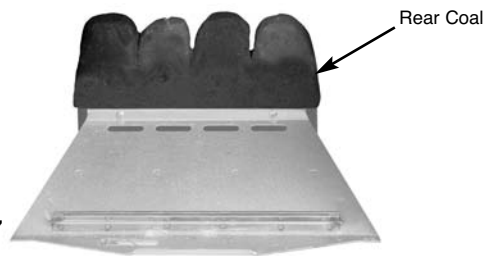

Fig. 37

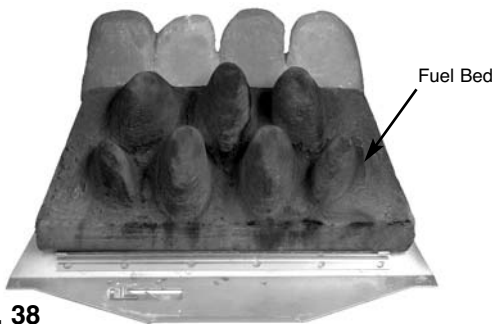

Fig. 38

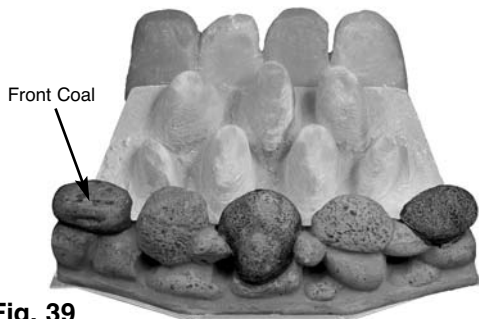

Fig. 39

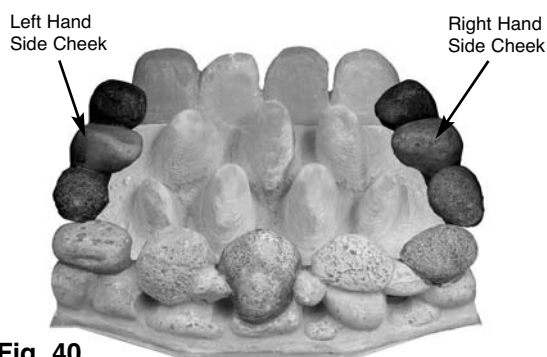

Fig. 40

**It is very important that all the pebbles are used and arranged as shown in order to achieve the desired flame picture.**

It may be necessary to remove some or all of the pebbles to clean them at some time. Cleaning must only be done using a soft brush.

**CAUTION:** The pebbles are extremely fragile and must be handled accordingly. Gloves should be worn and any inhalation of dust should be avoided. The pebbles must be kept away from children at all times. Never put additional pebbles on the fire. Never use pebbles other than those originally supplied, or genuine Legend Spare Parts.

1. Place the rear coal on the rear coal retainer ledge in a central position (Fig. 37).
  
2. Place the main fuel bed on to the middle section of the metal burner tray. It is important that the front edge of the fuel bed is located behind the burner strip (Fig. 38).
  
3. Position the front coal on the front coal retainer, making sure that the back edge is pushed up against the front of the burner strip (Fig. 39).
  
4. Place the side cheeks into position, making sure they are positioned either side of the fuel bed and the overhang is at the front. The outside edge should be in contact with the radiant box ceramic liner. Ensure that the lower part of the side cheeks sit on the front coal and are in front of the rear coal (Fig. 40).





5. Following Figs. 41 to 43, place the loose pebbles on to the fuel bed. It is important that the pebbles 'nest' together and sit on top of the fuel bed peaks.

6. Make any adjustments necessary to achieve even gaps as this will help in giving a well balanced flame picture and an even glow. After running the fire for 30 minutes, it may be necessary to adjust the pebbles with tongs.

Where possible, make sure that the flames do not play on the ceramic fire box liners, as this may cause sooting.

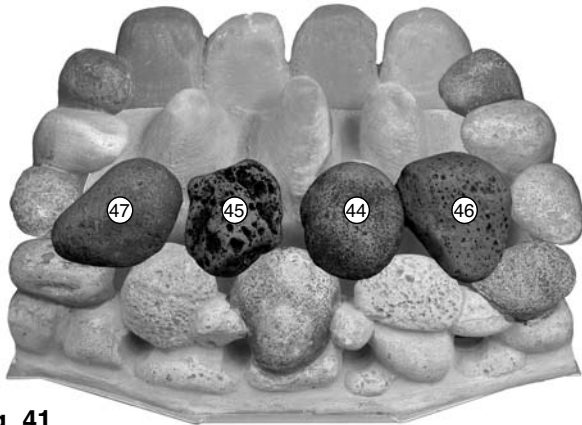

**Fig. 41**

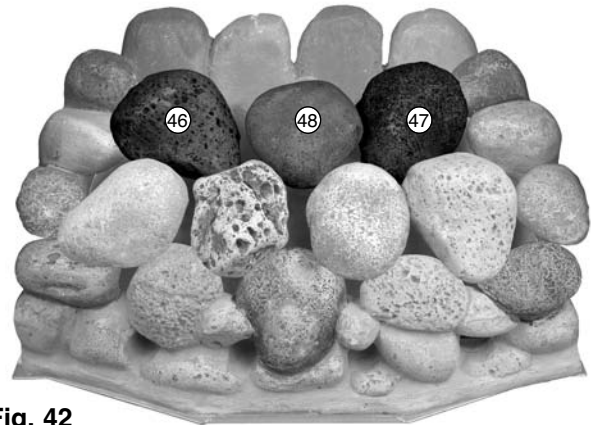

**Fig. 42**

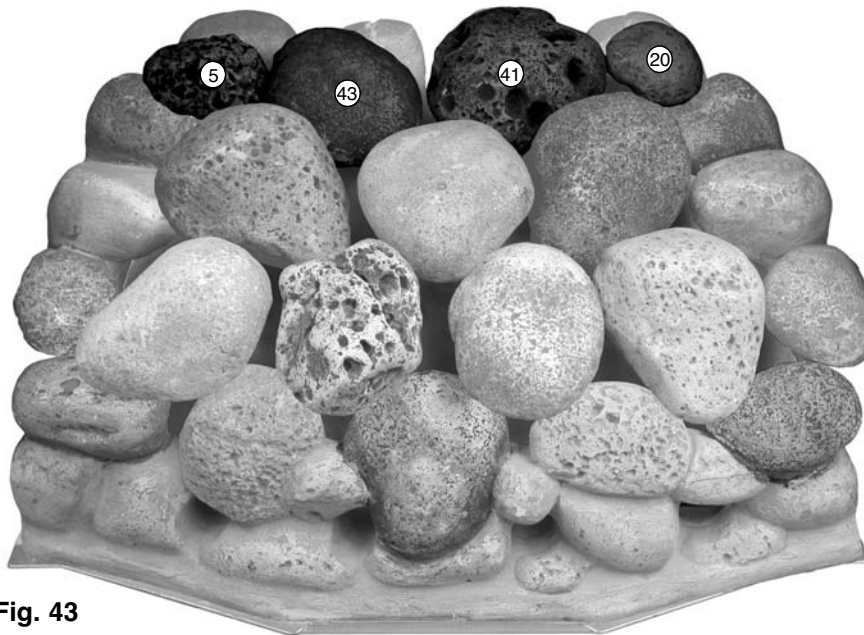

**Fig. 43**

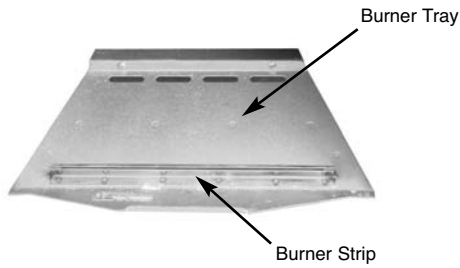

Fig. 44

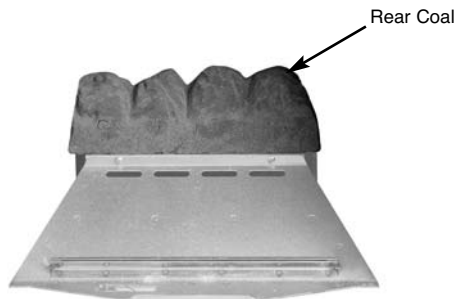

Fig. 45

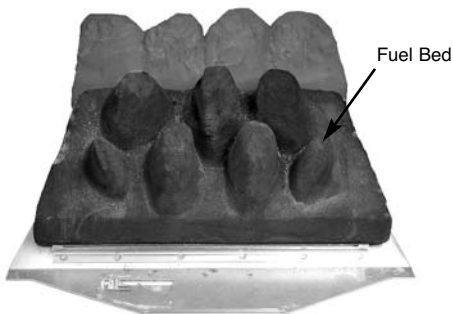

Fig. 46

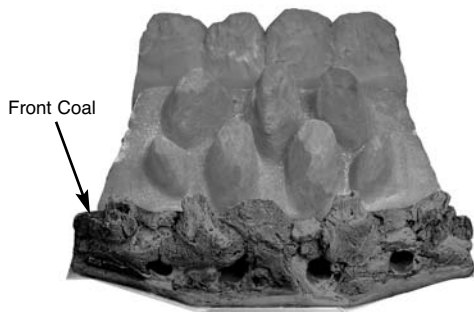

Fig. 47



Fig. 48

**It very is important that all the logs are used and arranged as shown in order to achieve the desired flame picture.**

It may be necessary to remove some or all of the logs to clean them at some time. Cleaning must only be done using a soft brush.

**CAUTION:** The logs are extremely fragile and must be handled accordingly. Gloves should be worn and any inhalation of dust should be avoided. The logs must be kept away from children at all times. Never put additional logs on the fire. Never use logs other than those originally supplied, or genuine Legend Spare Parts.

1. Place the rear coal on the rear coal retainer ledge in a central position (Fig. 45).
  
2. Place the main fuel bed on to the middle section of the metal burner tray. It is important that the front edge of the fuel bed is located behind the burner strip (Fig. 46).
  
3. Position the front coal on the front coal retainer, making sure that the back edge is pushed up against the front of the burner strip (Fig. 47).
  
4. Place the side cheeks into position, making sure they are positioned either side of the fuel bed and the overhang is at the front. The outside edge should be in contact with the radiant box ceramic liner. Ensure that the lower part of the side cheeks sit on the front coal and are in front of the rear coal (Fig. 48).

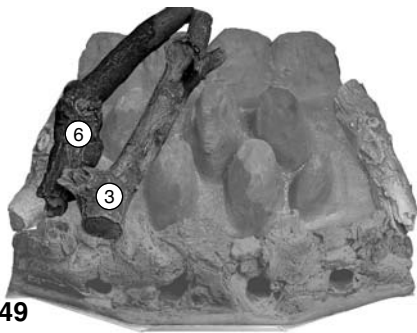

**Fig. 49**

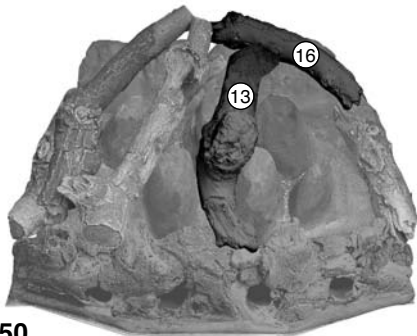

**Fig. 50**

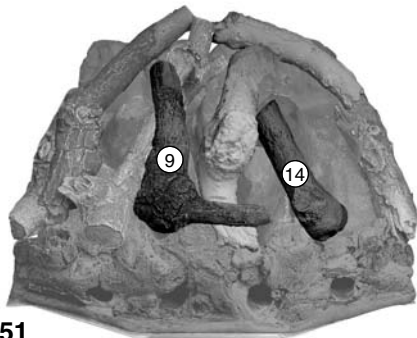

**Fig. 51**

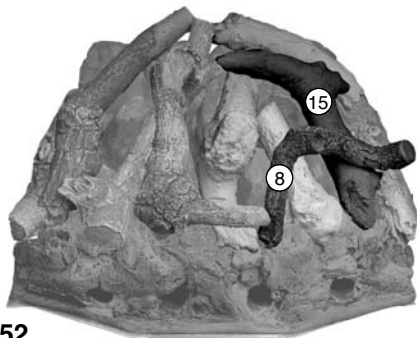
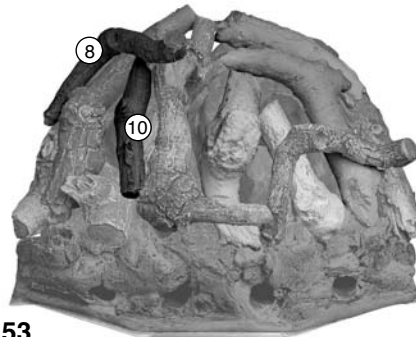

**Fig. 52**

5. Following Figs. 49 to 55, place the loose logs on to the fuel bed. It is important that the logs ‘nest’ together and sit on top of the fuel bed peaks.

6. Make any adjustments necessary to achieve even gaps as this will help in giving a well balanced flame picture and an even glow. After running the fire for 30 minutes, it may be necessary to adjust the logs with tongs.

Where possible, make sure that the flames do not play on the ceramic fire box liners, as this may cause sooting.



**Fig. 53**

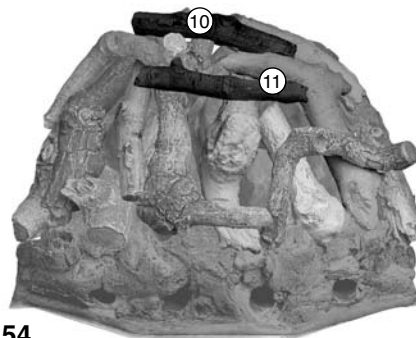

**Fig. 54**



**Fig. 55**

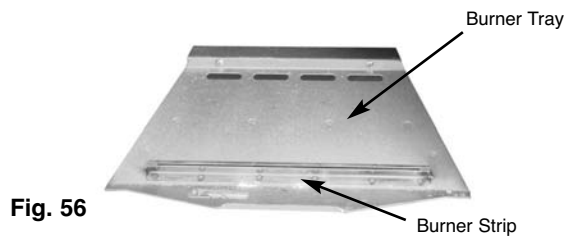

Fig. 56

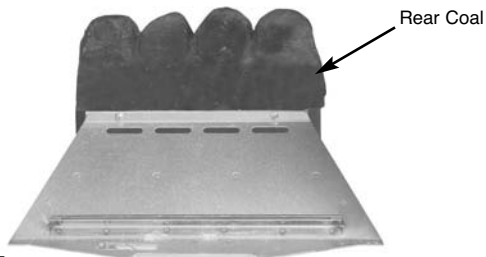

Fig. 57

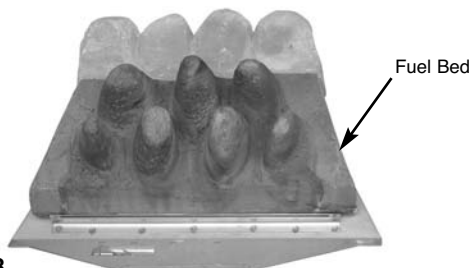

Fig. 58

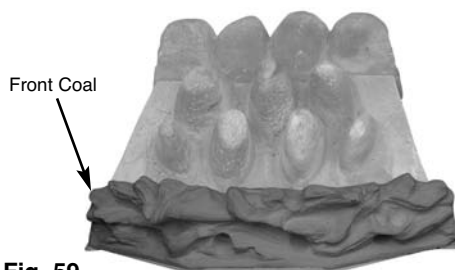

Fig. 59



Fig. 60

**It is very important that all the Driftwood is used and arranged as shown in order to achieve the desired flame picture.**

It may be necessary to remove some or all of the Driftwood to clean them at some time. Cleaning must only be done using a soft brush.

**CAUTION:** The driftwood is extremely fragile and must be handled accordingly. Gloves should be worn and any inhalation of dust should be avoided. The driftwood must be kept away from children at all times. Never put additional driftwood on the fire. Never use driftwood other than that originally supplied, or genuine Legend Spare Parts.

1. Place the rear coal on the rear coal retainer ledge in a central position (Fig. 57).

2. Place the main fuel bed on to the middle section of the metal burner tray. It is important that the front edge of the fuel bed is located behind the burner strip (Fig. 58).

3. Position the front coal on the front coal retainer, making sure that the back edge is pushed up against the front of the burner strip (Fig. 59).

4. Place the side cheeks into position, making sure they are positioned either side of the fuel bed and the overhang is at the front. The outside edge should be in contact with the radiant box ceramic liner. Ensure that the lower part of the side cheeks sit on the front coal and are in front of the rear coal (Fig. 60).



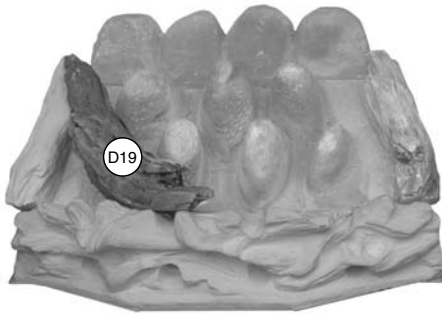

Fig. 61

6. Following Figs. 61 to 67, place the loose driftwood pieces onto the fuel bed. It is important that the driftwood 'nests' together and sits on top of the fuel bed peaks.

7. Make sure all the gaps are even in order to obtain a balanced flame picture and efficient combustion.

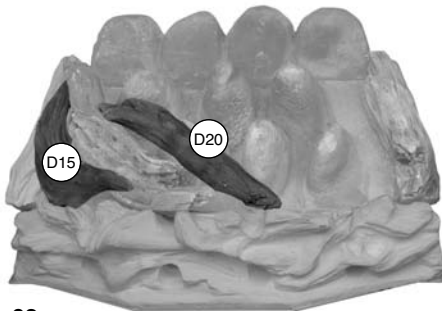

Fig. 62

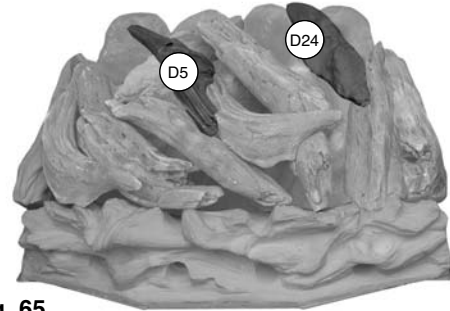

Fig. 65

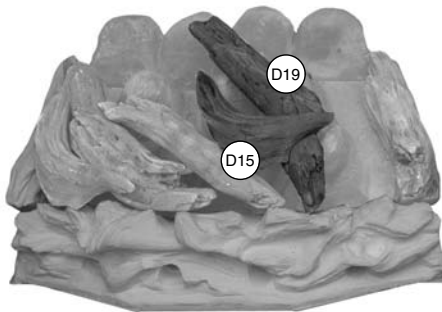

Fig. 63

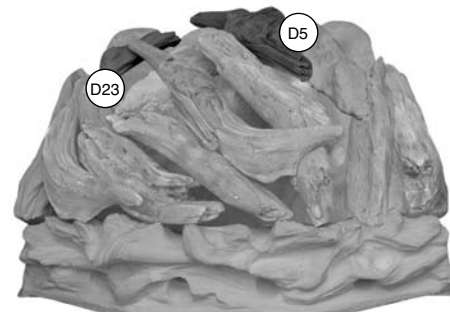

Fig. 66

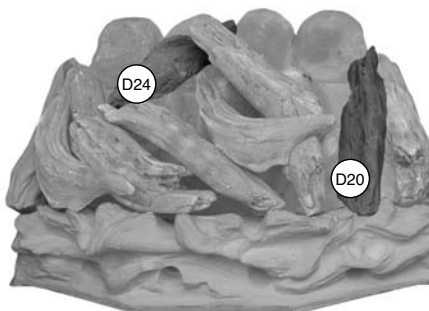

Fig. 64



Fig. 67



**CAUTION:** The coals are extremely fragile and must be handled accordingly. Gloves should be worn and any inhalation of dust should be avoided. Never put additional coals on the fire. Never use coals other than those originally supplied, or genuine Legend Spare Parts.

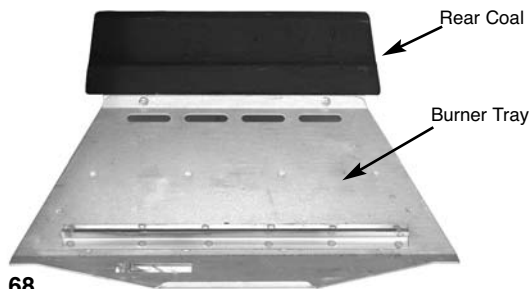

Fig. 68

1. Place the rear coal on the rear coal retainer ledge in a central position, ensuring the step portion is facing the front (Fig. 68).

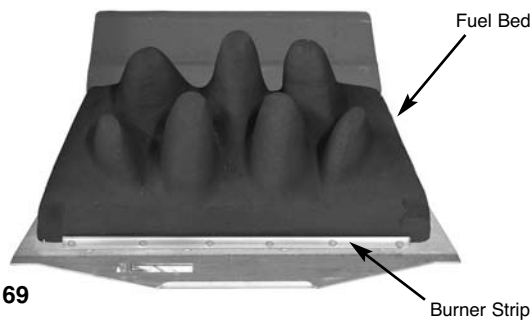

Fig. 69

2. Place the main fuel bed on to the middle section of the metal burner tray. It is important that the front edge of the fuel bed is located behind the burner strip (Fig. 69).



Fig. 70

3. Position the front coal piece on the front coal retainer, making sure that the back edge is pushed up against the front of the burner strip. Ensure that the lugs on the rear of the front coal are located at either end of the burner strip (Fig. 70).

4. Locate the remaining coal pieces in order as shown in Figs. 71 to 74.



Fig. 71



Fig. 72



Fig. 73



Fig. 74

5. Finally check that all the coal pieces are 'nested' together correctly (Fig. 75).

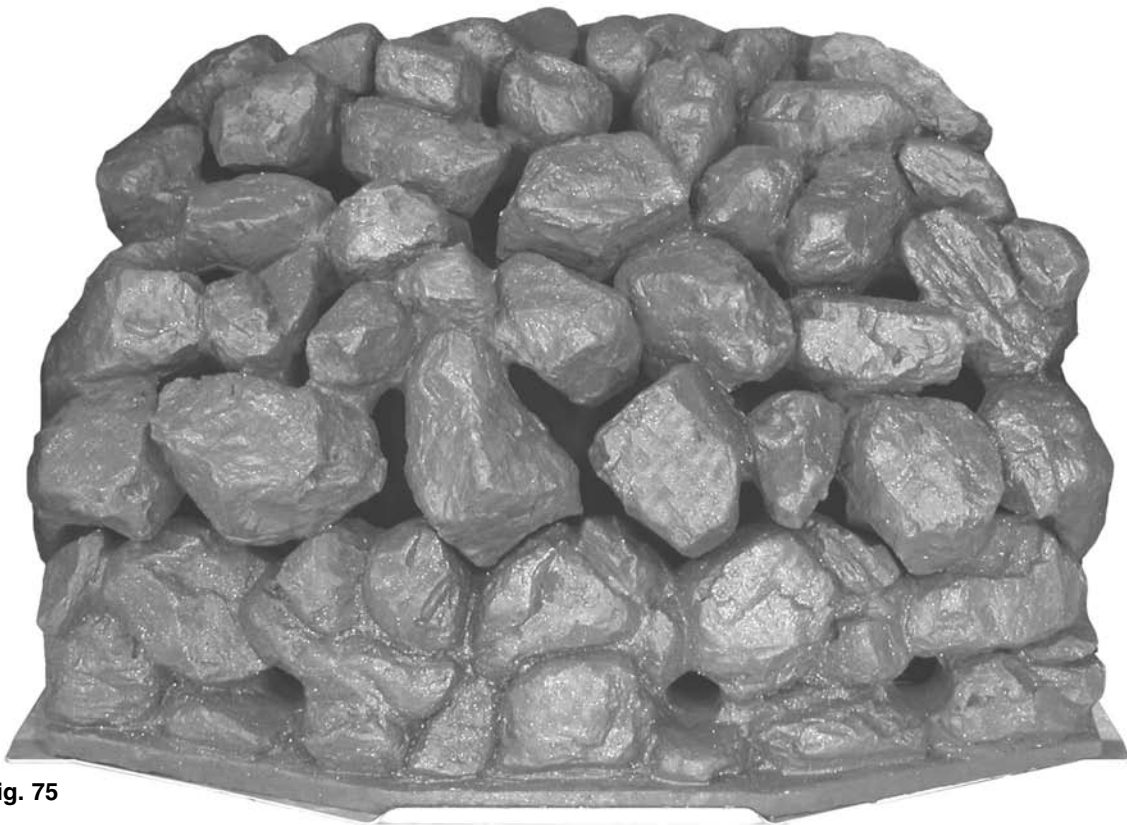

Fig. 75

**It is very important that all the coals are used and arranged as shown in order to achieve the desired flame picture.**

It may be necessary to remove some or all of the coals to clean them at some time. Cleaning must only be done using a soft brush.

Ceramic touch-up dye is available from Legend Fires.



**CAUTION:** The pebbles are extremely fragile and must be handled accordingly. Gloves should be worn and any inhalation of dust should be avoided. Never put additional pebbles on the fire. Never use pebbles other than those originally supplied, or genuine Legend Spare Parts.

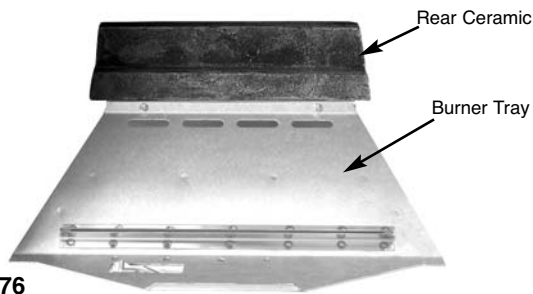

**Fig. 76**

1. Place the rear ceramic on the rear ceramic retainer ledge in a central position, ensuring the step portion is facing the front (Fig. 76).

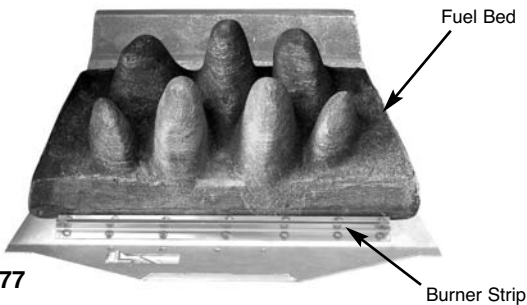

**Fig. 77**

2. Place the main fuel bed on to the middle section of the metal burner tray. It is important that the front edge of the fuel bed is located behind the burner strip (Fig. 77).



**Fig. 78**

3. Position the front pebble piece on the front ceramic retainer, making sure that the back edge is pushed up against the front of the burner strip. Ensure that the lugs on the rear of the front pebble are located at either end of the burner strip (Fig. 78).

4. Locate the remaining pebble pieces in order as shown in Figs. 79 to 82.



**Fig. 79**



**Fig. 80**





Fig. 81



Fig. 82

5. Finally check that all the pebble pieces are 'nested' together correctly (Fig. 83).



Fig. 83

**It is very important that all the pebbles are used and arranged as shown in order to achieve the desired flame picture.**

It may be necessary to remove some or all of the pebbles to clean them at some time. Cleaning must only be done using a soft brush. Ceramic touch-up dye is available from Legend Fires.

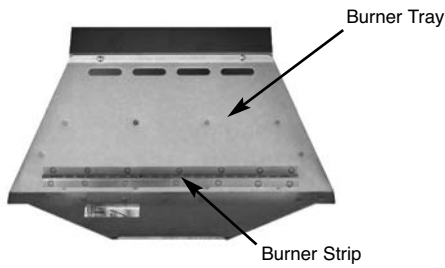

Fig. 84

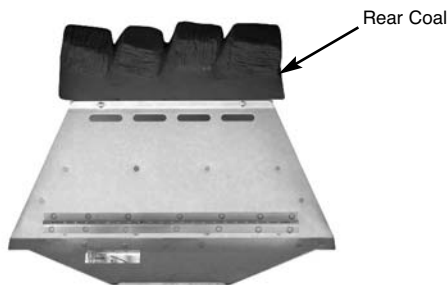

Fig. 85

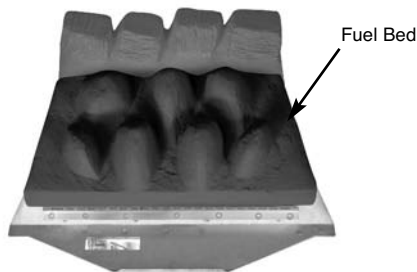

Fig. 86

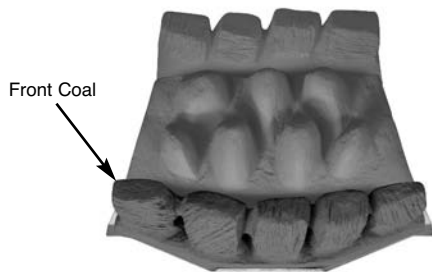

Fig. 87



Fig. 88

**This ceramic ripped coal set is for use on Natural Gas appliances only.**

**It very is important that all the coals are used and arranged as shown in order to achieve the desired flame picture.**

It may be necessary to remove some or all of the coals to clean them at some time. Cleaning must only be done using a soft brush.

**CAUTION:** The coals are extremely fragile and must be handled accordingly. Gloves should be worn and any inhalation of dust should be avoided. The coals must be kept away from children at all times. Never put additional coals on the fire. Never use coals other than those originally supplied, or genuine Legend Spare Parts.

1. Place the rear coal on the rear coal retainer ledge in a central position (Fig. 85).

2. Place the main fuel bed on to the middle section of the metal burner tray. It is important that the front edge of the fuel bed is located behind the burner strip (Fig. 86).

3. Position the front coal on the front coal retainer, making sure that the back edge is pushed up against the front of the burner strip (Fig. 87).

4. Place the side cheeks into position, making sure they are positioned either side of the fuel bed and the overhang is at the front. The outside edge should be in contact with the radiant box ceramic liner. Ensure that the lower part of the side cheeks sit on the front coal and are in front of the rear coal (Fig. 88).



Fig. 89

5. Following Figs. 89 to 92, place the loose coals on to the fuel bed. It is important that the coals 'nest' together and sit on top of the fuel bed peaks.

6. Make any adjustments necessary to achieve even gaps as this will help in giving a well balanced flame picture and an even glow. After running the fire for 30 minutes, it may be necessary to adjust the coals with tongs.

Where possible, make sure that the flames do not play on the ceramic fire box liners, as this may cause sooting.



Fig. 90



Fig. 91



Fig. 92

## GUARANTEE



Your appliance is guaranteed for one year from proof of purchase. Should the appliance prove defective within that period we agree to repair or replace (at our discretion) the component or appliance provided that:

1. The user can produce a receipt for proof of purchase/installation.
2. The appliance has been supplied by an authorised stockist and has been installed by a qualified installer, all installation and operating instructions have been strictly adhered to.
3. No alterations have been carried out on the appliance or component parts without our written consent.
4. The appliance has not been used for any purpose other than those intended.
5. The appliance has not been damaged accidentally or due to fair wear and tear.

Guarantee claims should be made through your appliance supplier. The Guarantee is restricted to UK Mainland and is additional to your statutory rights.

## TROUBLE SHOOTING (USER)

### 1. The Fire will not light.

Remove the brass fret and check the pilot area for soot.  
If soot is present remove all the loose coals and the front coal and thoroughly clean any debris in and around the pilot area.  
If the fire will still not light contact your installer.

### 2. The flames appear blue - excessive soot deposits.

The ceramic components including the coal need relaying (pages 16 - 31).  
Too much or too little room ventilation. Seek professional advice.

### 3. Roaring noise coming from the pilot.

The front coal is not seated correctly. Turn the appliance off and allow to cool down. Re-seat front coal, ensuring it is flat to the base of the front coal retainer (pages 16,18, 20, 22, 24, 26, 28 & 30).

### 4. All the Ceramic Components are discolouring.

The ceramic sets and liners are all manufactured from ceramic fibre and its natural colour is white, dyes are used to give it a realistic appearance. These dyes discolour after they have been subjected to intense heat. However the discolouration does not affect the operation of the appliance. The realistic appearance can be restored with the use of a good replacement dye that can be purchased from most good fireplace showrooms.

---

Legendfires 

Unit 404  
Glenfield Park Business Centre  
Blakewater Road  
Blackburn  
Lancashire  
BB1 5QH

Tel: 01254 695244

Fax: 01254 695255

Web: [www.legend-fires.com](http://www.legend-fires.com)

Email: [info@legend-fires.com](mailto:info@legend-fires.com)

OP033 - Issue 18 - 19/01/18