

Vantage Remote Control

- Coal, Pebble, Deluxe Pebble, Log, Driftwood, Modular Coal, Modular Pebble & Ripped Coal Effect
 - Inset Live Fuel Effect Gas Fires
-



Installation and Users Instructions

These instructions should be read by the installer before installation and then should be handed to the end user when the installation is complete.

This is an official requirement and is the responsibility of the fitter of this appliance.

Having installed the appliance, the installer should take the necessary steps to ensure that the user fully understands how to operate the appliance and is also made aware of the fire's basic cleaning and maintenance requirements.



SECTION	PAGE
Notes for the Installer and End User	3
Installation Requirements	4
Installation Procedure	5
Commissioning	6
Technical Data	7
Replacement Parts	7
Trouble Shooting (GAS SAFE Engineer Only)	8
Remote Control Component Layout	9
Test Sequence	11
Fault Finding Table	12
User Instructions	13
Cleaning and Maintenance	14
Fire Front Specifications	15
Coal Layout Instructions	16
Pebble Layout Instructions	18
Deluxe Pebble Layout Instructions	20
Log Layout Instructions	22
Driftwood Layout Instructions	24
Modular Coal Layout Instructions	26
Modular Pebble Layout Instructions	28
Ripped Coal Layout Instructions	30
Guarantee	32
Trouble Shooting (User)	32



THIS APPLIANCE IS INTENDED FOR DECORATIVE PURPOSES

This appliance has been designed, tested and manufactured to the European Standard EN509 relating to Decorative Gas Appliances and **must** be installed by a qualified GAS SAFE Registered Installer in accordance with the Gas Safety (Installation and use) regulations 1994 and all other relevant standards.

This appliance must be connected in accordance with the National Regulations. The appliance must be sealed into a non-combustible fireplace (Fig. 2) whose only opening must be through a Class I (7" or 175mm diameter) or Class II (5" or 125mm diameter) chimney/flue of at least three metres in height.

Before installation, ensure that the local conditions (identification of gas type and pressure) and the adjustment of the appliance are compatible.

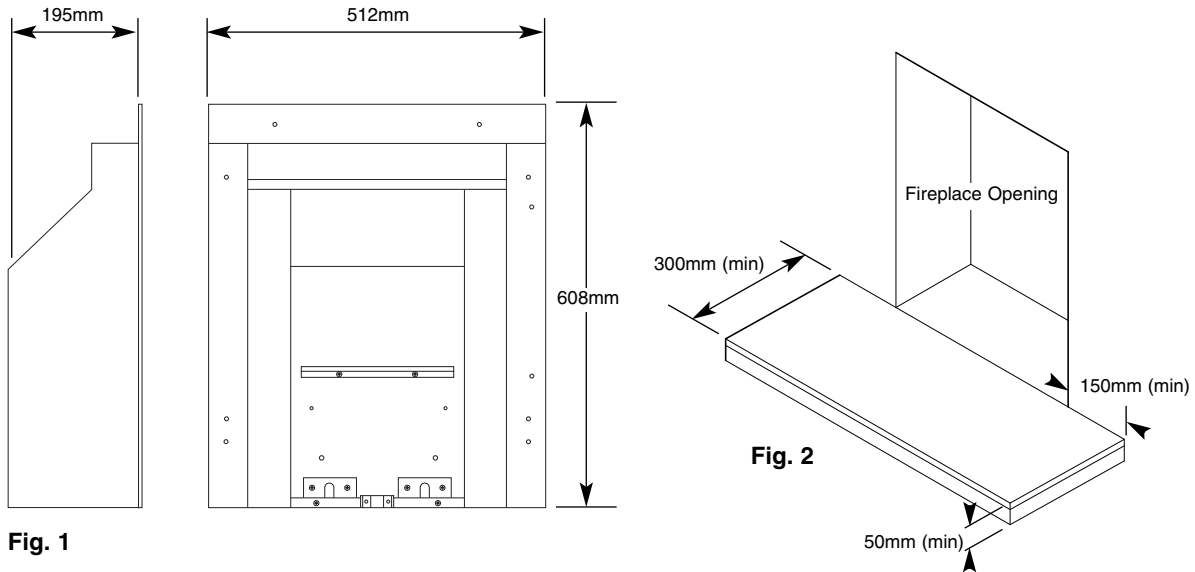

Fig. 1

Fig. 2

An air vent is not normally required for this application because its input does not exceed 7kW. We recommend that the chimney/flue is swept prior to installation of this appliance and that any flue restrictor or damper plate should be removed or fixed in the open position. The chimney/flue must always generate a positive up draught to ensure safe operation.

The installer must then establish that all the products of combustion are entering the flue within five minutes of lighting from cold. This can be verified by traversing the canopy with a lighted smoke match (see 'Spillage Test' page 4).

An isolation valve must be fitted adjacent to the appliance. When closed, this will allow the complete burner and control assembly to be disconnected for maintenance or repair in accordance with national regulations.

The gas supply should be provided by a semi rigid pipe with an 8mm diameter and should be no longer than 1.5 metres in length.

NOTE: When the gas supply pipe is passed through masonry or other brickwork always ensure that the end of the pipe is covered to avoid any debris passing through into the appliance controls.

The appliance is fitted with an Oxygen Depletion Sensor (ODS) that monitors the room for products of combustion. If products are detected, the ODS will automatically shut down the appliance. If this situation arises, re-light the appliance, referring to the user instructions (page 13). If shut down re-occurs, a qualified person must be called to thoroughly check the appliance. The spillage monitoring system (ODS pilot) must not be put out of operation or be tampered with or adjusted by either the installer or the user. If the unit is found to be at fault it should be replaced with the manufacturers original replacement parts.



This appliance must only be installed in Great Britain or Ireland.

1. This fire is either a natural gas or LPG appliance and has been designed for use with the following applications:

- a) **Class I** - Conventional brick or stone chimney as used for a solid fuel fire with a cross sectional dimension of 225mm x 225mm (9" x 9") or a lined flue with a minimum diameter of 175mm (7"), with the fireplace components conforming to BS1251, or a builders opening a minimum of 560mm high and 406mm wide with a minimum depth of 230mm to allow sufficient volume for debris collection. To obtain this depth it would not normally be necessary to remove the chair brick. Any permanent flue restrictions or variable dampers are to be removed or locked in the fully open position. The chimney should also be swept prior to installation.
- b) **Class II** - A double walled or insulated metal flue box built to the requirements of BS715 with an insulated flue having a minimum diameter of 125mm (5") and a minimum effective overall height of 3 metres (10').

Note: If the flue box is to be used with an existing brick or stone chimney a 125mm (5") minimum diameter flue liner conforming to BS 715 may be used.

2. A non-combustible hearth must be provided to comply with current building regulations. Care should be taken to prevent any damage being caused to surrounding soft furnishings or decoration, e.g. many embossed vinyl wall coverings may become discoloured if placed too close to the appliance.
3. A suitable proprietary fire surround with 100°C rating may be used with a minimum clearance from hearth to underside of shelf of 830mm, providing that the depth of shelf is 150mm or less.
4. Where the shelf depth is greater than 150mm, the minimum height clearance should be increased by 25mm increments for each additional 12.5mm of shelf depth.
5. Minimum width between vertical sides of combustible surround should not be less than 800mm provided the appliance is central to the surround and the surround legs do not exceed a 150mm profile.
6. If the 150mm profile is exceeded, the width of the surround (and the back panel) should be increased by 25mm for each additional 12.5mm of profile depth.

FLUE FLOW TEST

A flue flow test (smoke test) is carried out to check the effectiveness of the flue and to ensure that there is no leakage into another part of the premises (including any loft), or as appropriate other adjoining premises (this is particularly important where a number of chimneys combine into a multiple stack).

The flue flow test should be carried out using a suitable smoke pellet which the pellet manufacturer claims to generate 5 m³ of smoke in 30 seconds burn time.

These gas fires should have the flue flow test carried out with the appliance in position but not connected to the gas supply so that the smoke test can be carried out with representative flue flow conditions.

A warm flue will be more effective than a cold flue. If the flue is reluctant to draw, which can be initially assessed by lighting a smoke match at the intended position of the appliance flue connection, introduce some heat into the flue for a minimum of 10 minutes using a blow torch or other means.

Other factors, such as weather conditions and a combination of materials used to construct the flue can all influence the flue draught. The pre-heating process may require as much as half an hour before the flue behaves satisfactory as a blow torch does not represent the volume of heat consistent with the normal appliance operation.

A Flue Flow Test should be checked as follows:

1. Carry out those visual checks as indicated previously, and continue only if satisfactory.
2. Establish that an adequate air supply is available for the combustion of the appliance
3. Close all doors and windows in the room that the appliance is to be installed.
4. Light a smoke pellet at the intended position for the appliance. Place the inset fire case into position.
5. The test is satisfactory if
 - there is no significant escape of smoke from the appliance position.
 - there is no seepage of smoke over the length of the flue.
 - smoke is discharged only from the correct terminal.

VENTILATION

No special ventilation bricks or vents are required in the room containing the appliance, providing that normal adventitious room ventilation exists. The installer must determine this by carrying out a spillage test.

SPILLAGE TEST

To check for satisfactory clearance of products of combustion, close all doors and windows and leave the fire burning for five minutes. Insert a lit smoke match on a vertical plane 50mm down, 50mm inside the canopy opening. All the smoke must be drawn into the flue. If spillage occurs, allow a further ten minutes and repeat the test. Should spillage still occur turn the appliance off and seek expert advice.

To continue the test: If an extractor fan is situated in the room the test should be repeated with the fan running. If there is a connecting room with an extractor fan the test should be repeated with all the doors to that room open and the extractor fan running.



1. Carefully lift the appliance out of the packaging taking care not to damage the ceramic components in the separate carton.
2. Remove the magnetic trim and store to one side to prevent any damage.
3. Cut the foam sealing strip (in plastic bag supplied) to length and stick a continuous strip down the two sides and across the top of the radiant box. When the box is placed against a flat surface the foam strip will form a seal around the box's flange.
4. Carefully lift the appliance into position in the fireplace opening and check that the flange of the radiant box fits flush against the sealing face with no gaps present.
5. Remove the four screws that secure the burner tray to the box, two on the front leg and two at the rear of the tray. Remove the burner tray and place to one side (Fig. 3).

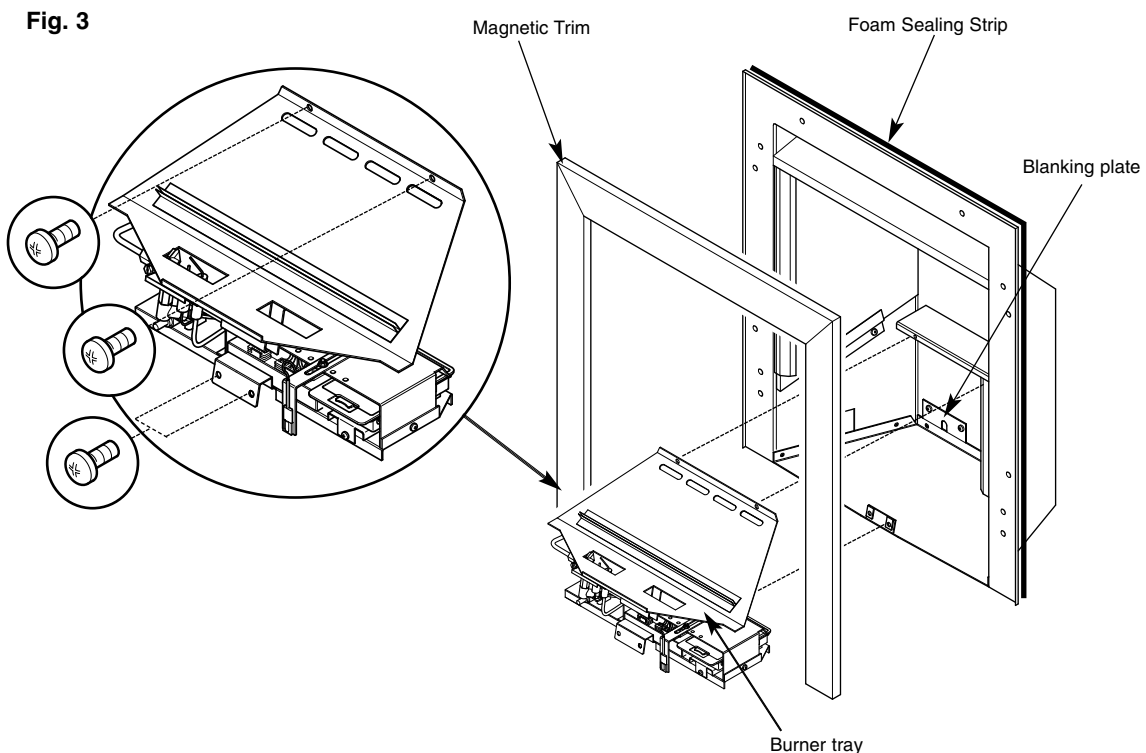

6. When the burner tray has been removed, decide which side of the appliance the gas supply will be entering the radiant box and remove the relevant blanking plate (left or right hand side). The gas supply should be concealed as much as possible.
7. With the radiant box placed in the opening, mark out four of the eight fixing holes. Remove the box and carefully drill and fit rawl plugs.

8. Pass the 8mm gas connection through the back of the box and secure the box into place using four screws (straight shank screws are recommended for marble). Check that the outer flange of the appliance is completely sealed against the back panel.

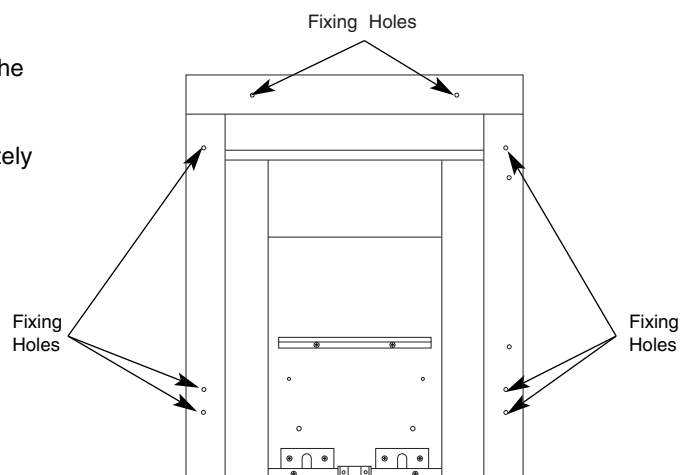

Fig. 4



ALTERNATIVE FIXING METHOD

Where the drilling of the back panel is not practical, an alternative fixing method may be employed using the cable fixing kit provided. Drill four holes in the rear of the fireplace opening (Fig. 5). Securely fix the four eye bolts provided using suitable rawl plugs. Feed one cable through each of the top holes in the rear of the fire box.

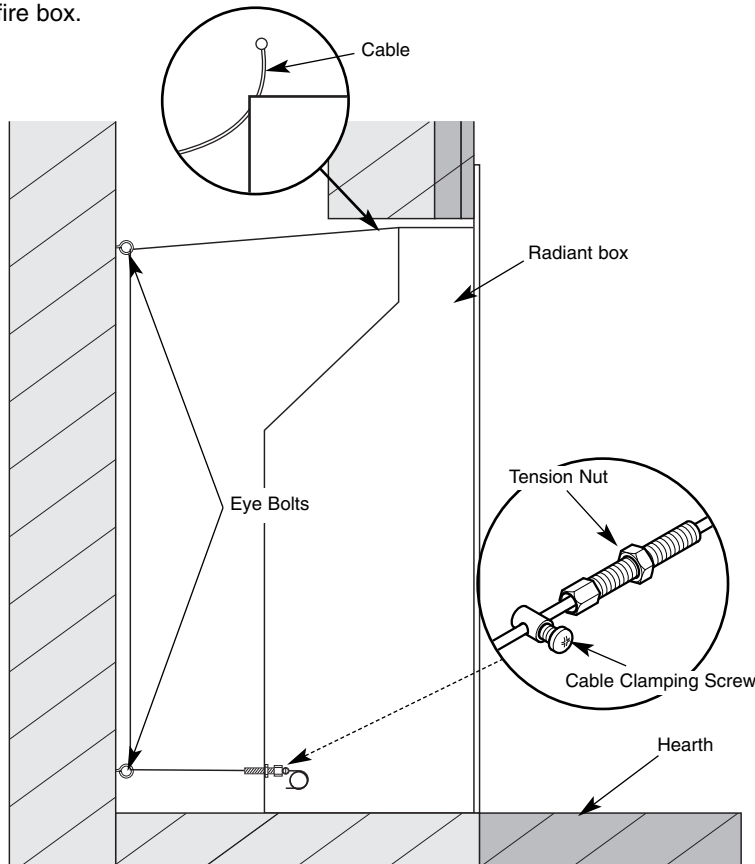

Fig. 6

Fix the radiant box into the opening, securing into position using the cable fixing kit (Fig. 6). Do not cut off the loose ends as the full length is required should the radiant box need refitting at any time. Coil up and securely store underneath the burner tray.

1. Position the burner tray into the box in order to determine the length of 8mm gas supply needed and cut to length.
2. Before making the final connection, thoroughly purge the supply pipe to clear any foreign matter, i.e. masonry dust etc, as this could lead to blockages in the control valve and/or pilot assemblies.
3. Fix the burner in place using the four screws and make the gas connection. Carry out a gas soundness test.
4. Ensure that the bulbous side of the I.R sensor is facing the front and is positioned around the ash pan area so that there is a direct line of sight for the remote handset to operate correctly. The sensor bracket can be repositioned by loosening the retaining nut. Retighten the nut when adjustment is complete.

COMMISSIONING

1. Unscrew the pressure test point sealing screw (Fig. 7) and fit a manometer. Consult the user instructions (page 13). Ignite the appliance and turn to the high position.
2. Take a pressure reading and consult the technical data (page 7) to establish the correct working pressure.
3. Once the pressure has been checked and verified, turn off the appliance. Consult the ceramic component set up diagrams (pages 16-31) and fit the ceramics as per the instructions.

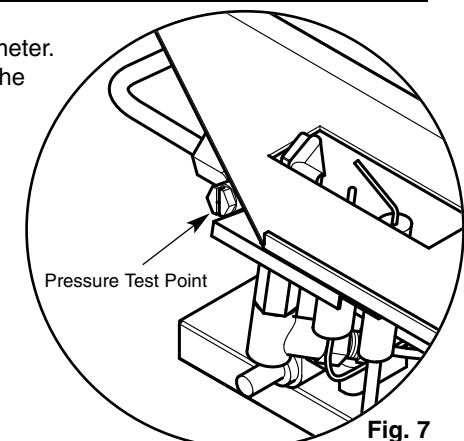

Fig. 7

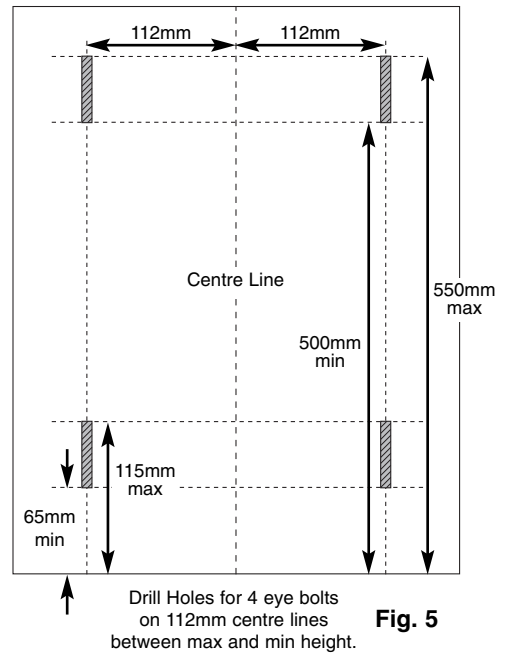

Fig. 5



Gas Type	Natural Gas (G20) Cat I _{2H}	LPG (G31) Cat I _{3P}
Gas Connection	8mm	8mm
Number of Injectors	One	One
Injector size	Stereomatic 072	Bray 92/150
Control Max Operating Temperature	80°C	80°C
Inlet Pressure Cold	20 mbar (8" W.G.)	37 mbar
Heat Input (Gross)	6.9 kW	5.1 kW
Weight	11.8 kg	11.8 kg

REPLACEMENT PARTS

1. **Loose coals** - The ceramic coals supplied with this appliance can be replaced at service intervals depending on their condition. If the coals do require replacement, the consumer can do so provided that the Ceramic Component Layout Instructions (pages 16-31) are adhered to. Under no circumstances should additional/extra coals be added. Only genuine Legend replacement parts should be used.

Order Ref: **Vancoa**

2. **Front Coal, and Fuel Bed, Side Cheeks and Rear Coal** - All these ceramic components can be replaced at service intervals depending on their condition. If the coals do require replacement, the consumer can do so provided that the Ceramic Component Layout Instructions (pages 16-31) are adhered to. Only genuine Legend replacement parts should be used.

Order Ref: **SPI2FC, VanFB, VanSC, VanCB**

3. **Oxygen Depletion Sensing Pilot** - In the unlikely event of a pilot failure, the pilot assembly should only be replaced by a **GAS SAFE Registered Engineer**. The user must not carry out this work.

Order Ref: **SSPI2PIL**

4. **Motorised Valve** - In the unlikely event of valve failure, the assembly should only be replaced by a **GAS SAFE Registered Engineer**. The user must not carry out this work.

Order Ref: **SPI2CON**

5. **Main Injector** - In the unlikely event of main injector failure, the fitting should only be replaced by a **GAS SAFE Registered Engineer**. The user must not carry out this work.

Order Ref: **SPI2INJ**

6. **Battery Pack** - When the batteries are becoming discharged, the fire will emit a continuous beeping sound. Please replace with good quality Alkaline or Lithium 6 x 1.5V AA.

Order Ref: **Lithpk1**

7. **Control Panel** - In the unlikely event of a control panel failure, the panel should only be replaced by a **GAS SAFE Registered Engineer**. The user must not carry out this work.

Order Ref: **Conpan1**



1. The Piezo will not spark.

- Check: The battery in the remote handset. The remote control handset generates an infrared signal that will be received by the sensor situated at the front of your fire. The signal requires a direct line of sight from the handset to the fire sensor. Ensure that the bulbous side of the I.R sensor is facing the front and there are no obstructions.
- The controls are powered by a lithium battery pack. When the power becomes low a beeping sound will continue every time the fire is in use. Please contact your supplier for a replacement.
- If the electrode is cracked or broken - Replace the pilot assembly.
- If the HT lead is shorting out on the burner body - Locate where the short is occurring, isolate and/or re-route the lead.
- If the HT unit/lead is faulty - Replace as necessary.

Note: The remote control system consists of four main replacement component parts: a. Thermocouple and pilot. b. Motorised gas control valve. c. Control panel. d. Battery pack. Please see page 10 for details of the layout including electrical connections. In order to access components a.b and c, it will be necessary to remove the burner tray. Refer to page 9 for the breakdown.

2. The Pilot will not light (but the Piezo is sparking).

- Check: If the gas is reaching the pilot - Check joints and connections.
- If the pilot jet is blocked - Inspect and clean.
- If the pilot is still not passing gas - Replace the pilot assembly.

3. The Pilot lights but goes out.

- Check: If the Thermocouple is loose/disconnected at the control valve - remake the connection.
- If the Thermocouple is faulty - Replace.
- If the Electro magnetic valve is faulty - replace valve.

4. The Burner will not light readily from the pilot.

- Check: If the coals are obstructing the pilot to burner path ie. Are the coals blocking the opportunity for the pilot to light the burner - Relay the coal set as per Ceramic Component Layout Instructions. (pages 16-31).

5. The fire makes a roaring noise when lit.

- Check: That the front coal is seated correctly and the pilot hole is positioned correctly over the pilot assembly.

IF ANY PART OF THE PILOT ASSEMBLY IS SUSPECTED AS BEING FAULTY THE COMPONENT MUST BE REPLACED.

6. The flames appear blue (after the fire has fully warmed up). The coals/ceramic liners have soot deposits.

- Check: That the coals have not moved from the original setting - Relay the coals as per the Ceramic Component Layout Instructions (pages 16-31).
- There may be too little/much ventilation into the room. Identify and then take steps to rectify.

7. The flame picture is low on the high setting.

- Check: For any partial blockages - Check all obvious locations for debris in pipe work and fittings.
- Inlet gas pressure, both standing and working gas pressure - Identify problem and take necessary steps to rectify. **Note:** Flame pattern improves with use.

8. Fumes enter the room when the fire is operating.

- Check: Why the chimney is not drawing all the products of combustion up the flue, identify where the problem lies and rectify, otherwise disconnect the fire and seek professional guidance.

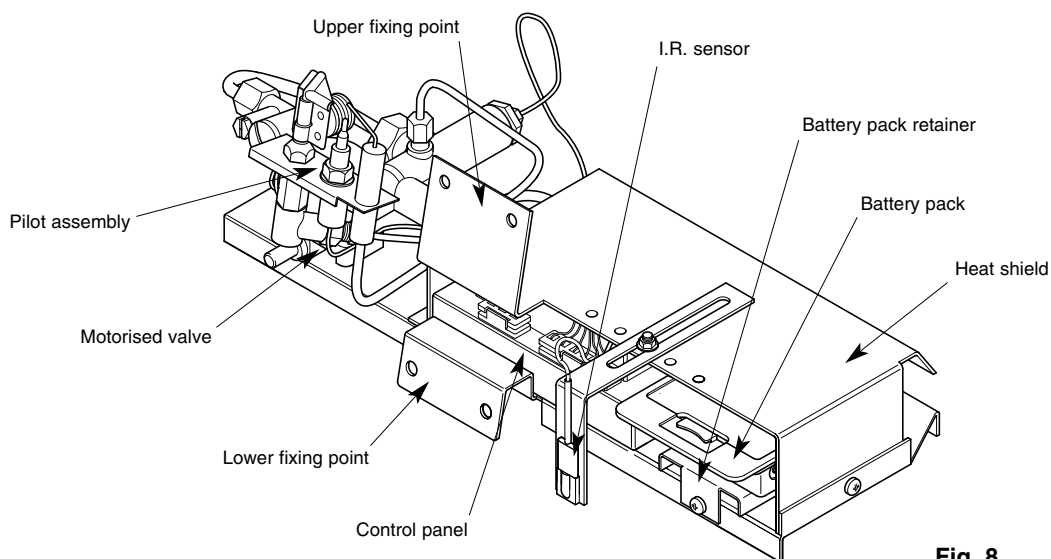

Fig. 8

In order to access:

- a. Pilot Assembly (including thermocouple)
- b. Motorised Control Valve
- c. Control Panel

It will be necessary to dismantle the burner tray. Please use the following procedure.

1. Ensure the appliance has fully cooled down.
2. Isolate gas supply.
3. Remove all the ceramic components off the fire and carefully placed to one side.
4. Working from the front of the fire, remove the lower fixing bracket screws and the two screws at the rear of the tray.
5. Disconnect the 8mm gas supply pipe using a 15mm spanner. This should then enable the burner to be removed from its housing.

Break-down for access to components

1. Working from the front of the fire remove the two upper fixing point screws.
2. Remove the two pilot assembly screws.
3. Working from the rear of the burner tray, remove the two silencer bracket screws.
4. Slide the silencer (white ceramic block) upwards which will then give you open access to the main gas injector.
5. Remove the locking nut and washer using a 14mm spanner.
6. Remove the burner tray from the remote control housing. This should give you access to the two screws that retain the heat shield to the remote base, thus giving unhindered access to all components.
7. Re-assembly is the exact reversal of the above procedure.

Note: When the batteries are becoming discharged, the fire will emit a continuous beeping sound. The battery pack is held in place with a single screw, remove this screw and the pack can slide out. Unclip the cover and replace the batteries with good quality alkaline or lithium - 6 x 1.5V AA (Fig.13 - Page 14).

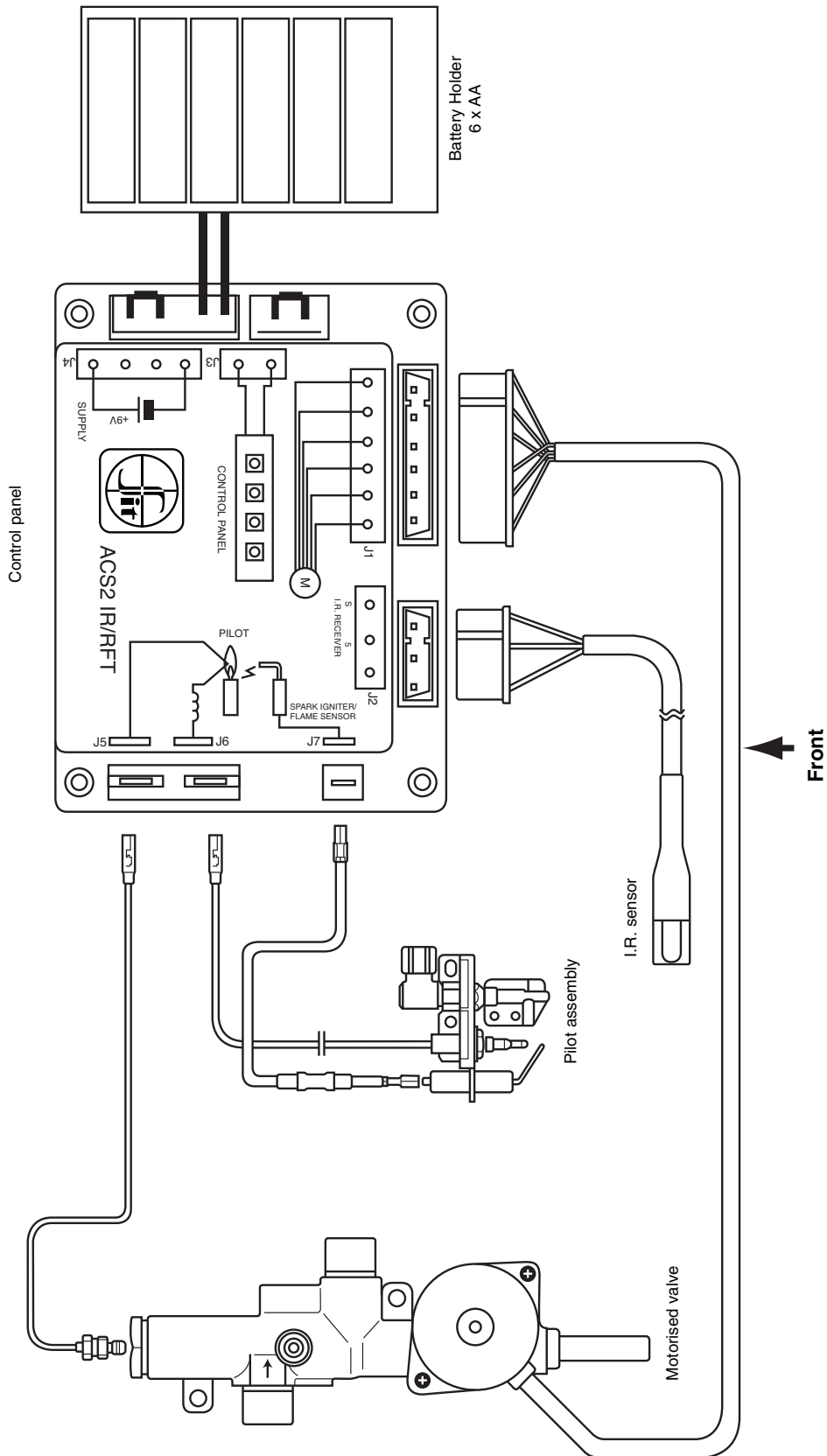

Fig. 9

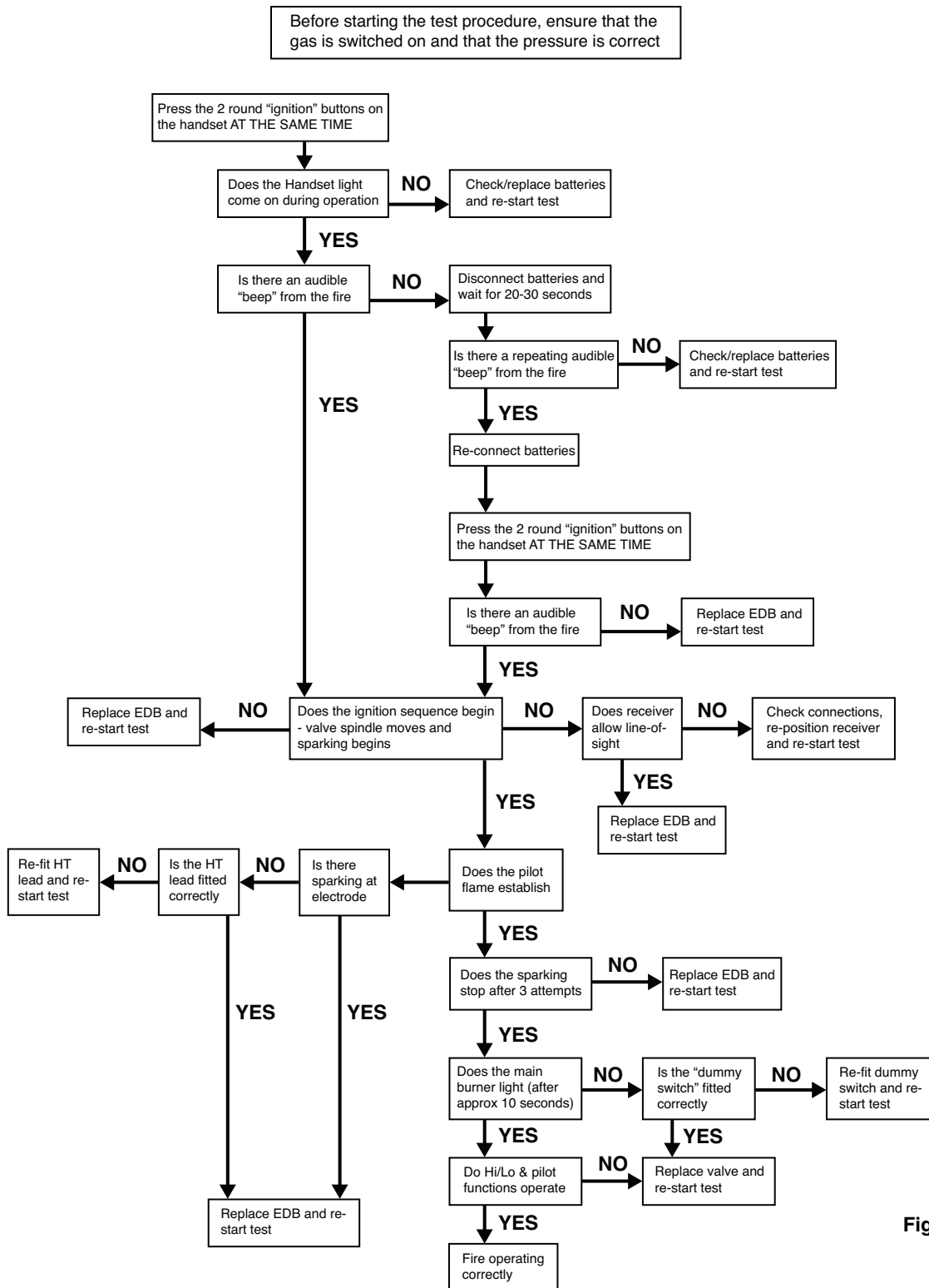

Fig. 10

Sound alarm (nr. of beeps)	Failure	Action
2	Low battery	Replace the batteries with good quality alkaline or lithium. 6 x 1.5V AA. Verify that sound alarm stops.
4	Motor failure	Substitute the valve with another one. Repeat the ignition sequence and verify the sound alarm stops.
5	Driver leakage	Substitute the board: the motor drive circuit is damaged. Execute an ignition sequence and verify there is no sound alarm.
6	Under voltage low battery	Replace the batteries with good quality alkaline or lithium. 6 x 1.5V AA. Verify that sound alarm stops.

FAULT FINDING TABLE



Symptom	Possible Cause	Action
No response from remote handset, no audible beep from the fire - handset indicator light does not illuminate.	Low power from handset battery.	Replace handset battery
No response from remote handset, no audible beep from the fire - handset indicator light illuminates.	Incorrect handset operation.	Ensure both (round) ignition buttons are being pressed simultaneously.
	No 'line of sight' to remote receiver.	Ensure handset is pointing directly at the receiver.
	poor positioning of receiver.	Ensure receiver is correctly positioned (domed surface pointing towards room) and allows 'line of sight' from the handset.
	Main batteries flat or broken connection.	Check power supply (multi-meter across terminals) and battery cable/connections - replace as necessary.
	Electronic 'lock-out' due to uncontrolled shut off (e.g. interrupted gas supply, thermocouple short-circuit*, safety pilot shutdown).	Reset the fire controls by pressing the top left button on the handset. Ensure thermocouple wire is not damaged and is not rubbing against any metalwork.
Main burner does not light - ignition sequence begins (audible beep), continuous sparking.	Pilot does not light - no gas supply to pilot/burner.	Check gas supply is 'ON'.
	Pilot does not light - no spark at electrode/pilot head.	Ensure ignition lead is correctly fitted at both ends (control board and pilot).
	Pilot lights correctly - control board not recognising flame.	Ensure thermocouple is connected to the control board and spade connections are not loose - replace board as necessary.
Main burner does not light at end of ignition sequence - ignition sequence begins (audible beep), sparking stops after three ignition attempts.	'Dummy switch' missing or faulty (appliance with remote control only).	Ensure switch socket on control board has a plug fitted (small plug with black loop).
	Low gas pressure.	Check gas pressure and that all taps/shut-offs are fully open and free of grease.
	Magnet unit not engaging correctly.	Replace valve.
	Fault in control board.	Replace control board.



THIS APPLIANCE IS INTENDED FOR DECORATIVE PURPOSES.

Please also familiarise yourself with the **Notes for the Installer and End User** on page 3.

OPERATION AND CONTROLS

It is most important that the operator of this gas appliance has fully read and understood all the operating, cleaning and maintenance procedures as laid out in these instructions.

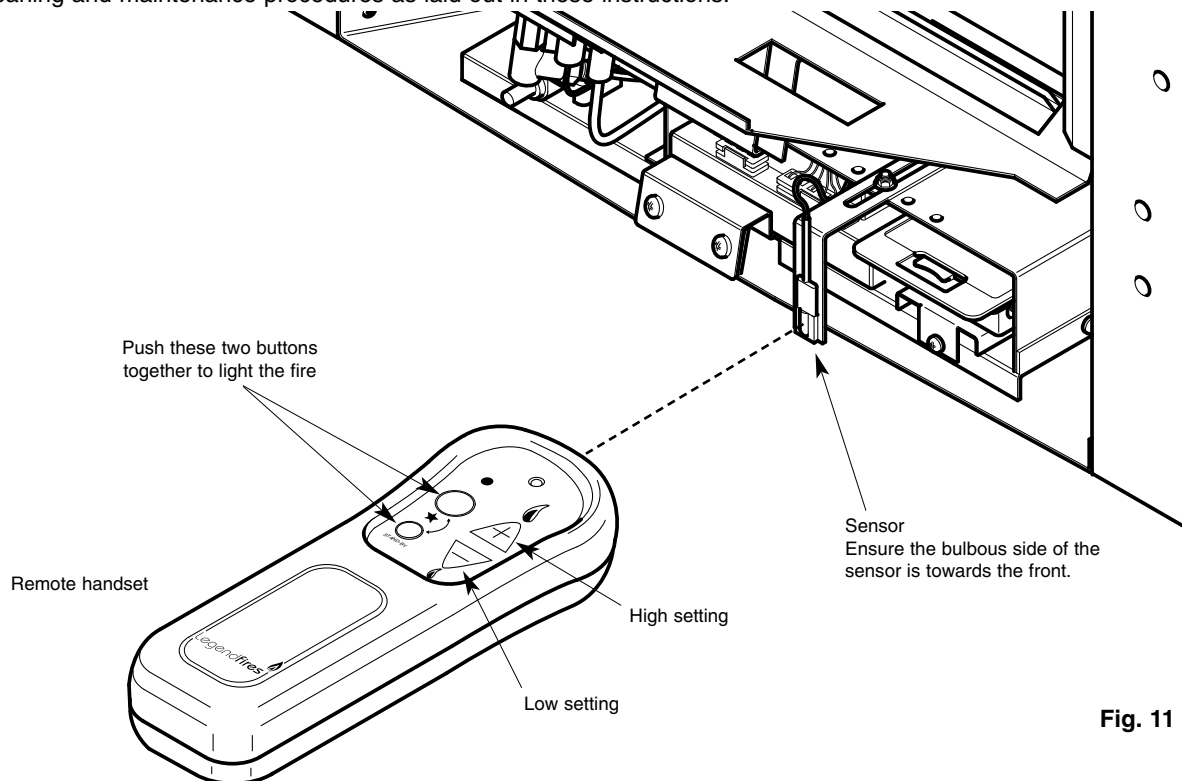

Fig. 11

Lighting Procedure

The remote control handset generates an infrared signal that will be received by the sensor situated at the front of the fire. The infrared signal requires a direct line of sight from the handset to the sensor on the appliance to ensure good operation.

To light the fire, point the handset at the sensor at the front of the fire. Push and hold the two buttons on the left hand side of the handset together. The appliance will make a beep sound and you can release the buttons. After a few seconds you will hear the clicking spark to the pilot light. Once the pilot is lit the fire's main burner will come on to the high position. This whole process should take no longer than 20 seconds.

After 30 minutes you can turn the fire down, point the handset at the sensor on the appliance then push and hold the minus button (small flame), if you release immediately the flame will go to low. If you hold the button down, the flame will lower slowly and you can release the button to your desired position. To turn the fire up, point the handset at the sensor and push the plus button until the desired flame height is reached.

The fire may be left in standby mode (pilot only) by pressing the small round button on the handset. To turn the fire off, point the handset at the sensor and push the top left button, the fire will go out.

NOTE: When the battery power is becoming low, the beeping sound will continue every time you use the fire. Please replace with good quality Alkaline or Lithium 6 x 1.5V AA.

NOTE: If for any reason the gas supply is interrupted whilst the fire is in use, it will be necessary to reset the fire controls by pressing the top left button on the handset.

WARNINGS:

Never throw any type of rubbish on or otherwise disturb the fuel bed.

Any alteration to this appliance including its ceramic components may render it inoperable and unsafe.

ALWAYS run this appliance on the high setting for the first 30 minutes (minimum) - Failure to do this may result in poor combustion and excessive sooting.



Legend Gas Fires recommend that this appliance is serviced at regular 12 monthly intervals. The chimney or flue should also be checked regularly to ensure that all products of combustion are entering the flue and there is no excessive build up of soot.

It is the users responsibility to ensure that the appliance is kept in a clean serviceable condition.

1. **Ceramic Components and Fuel Bed** - Debris from any source should be removed with a soft brush. Please ensure that any debris including soot deposits are removed from the appliance and not left on the fuel bed. It is recommended that the user should, on a regular quarterly basis, carefully remove all ceramic components and thoroughly clean the stainless steel burner strip and the pilot assembly. Any build up of debris in this area could affect the operation of the appliance.

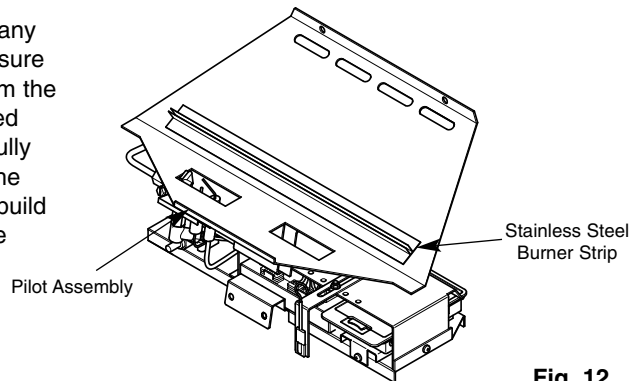

Fig. 12

NOTE: It is common to find surface cracks in the ceramic components. This is due to the expansion and contraction of the ceramic fibres caused by the intense heat that the burner generates. The cracks will not affect the safe operation of this appliance. However great care must be taken when handling the ceramic components as they will break if handled incorrectly. Do not use a vacuum cleaner to clean the ceramics.

2. **Radiant Box Ceramic Liners** - Use only a soft brush to remove any soot deposits from the ceramic liners during cleaning as this is the only method that can be used to remove deposits. The ceramic liners are very delicate and should be treated accordingly.

3. **Brass Trims and Frets** - The brass trim and fret should be removed from the appliance for cleaning, please ensure that the appliance has cooled thoroughly. Polished metal trims and frets are not lacquer coated and therefore require polishing. It is recommended that a good quality metal polish is used.

4. **Changing the batteries** - When the batteries are becoming discharged, the fire will emit a continuous beeping sound. The battery pack is held in place with a single screw, remove this screw and the pack can slide out. Unclip the cover and replace the batteries with good quality alkaline or lithium - 6 x 1.5V AA (Fig. 13).

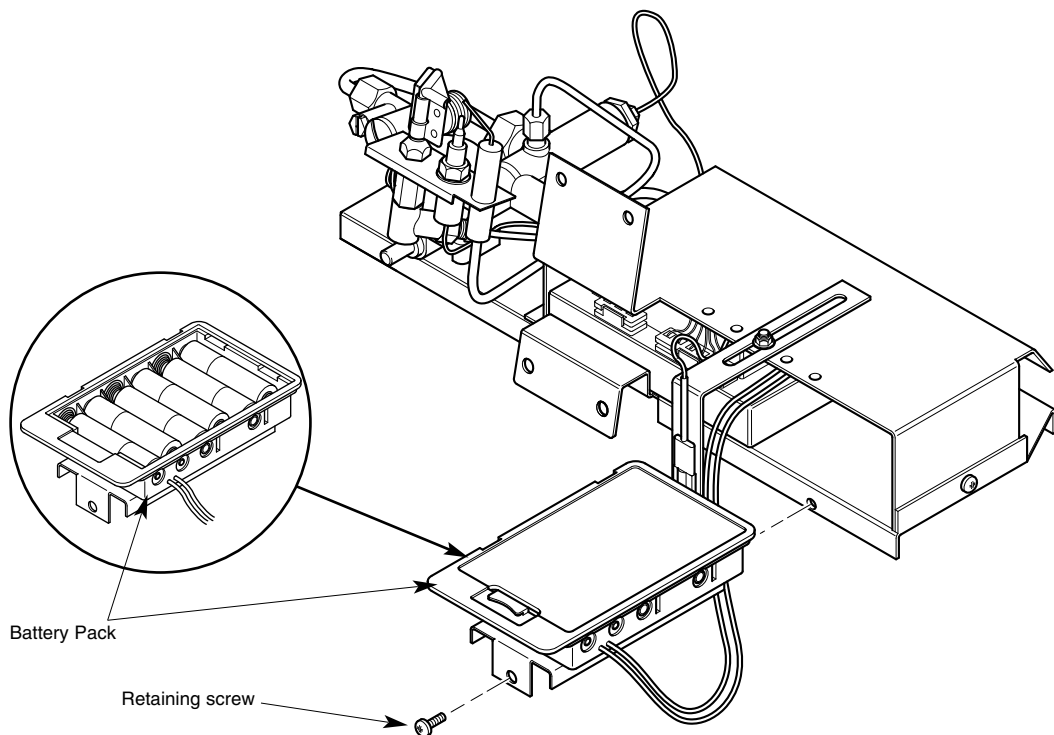

Fig. 13

FIRE FRONT SPECIFICATIONS



Fire fronts are now available in many different designs and finishes. The user can now choose their own particular style of fire front to suit their individual fireplace setting, providing the fire front complies with the following dimensions -

Fire Front -	(X) Max: 210mm	Min: 190mm
Ash Pan Cover -	(W) Max: 90mm	Min: 65mm
	(Y) Max: 345mm	Min: 320mm

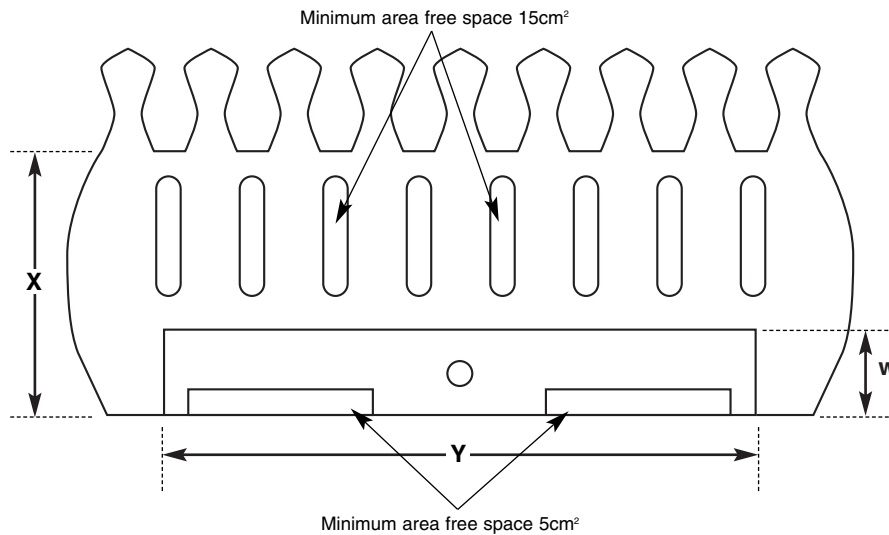
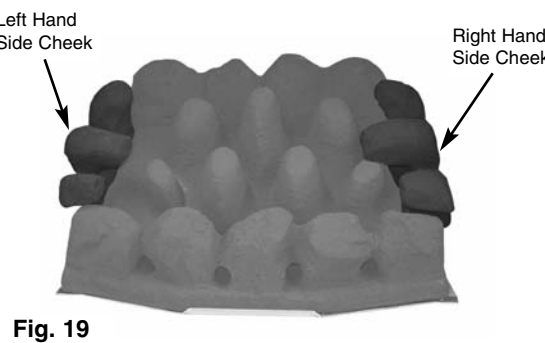
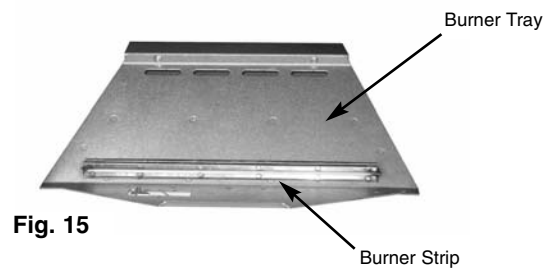

Fig. 14

SAFETY WARNING - This appliance has a naked flame and as with all heating appliances a fireguard should be used for the protection of children, the elderly and infirm. Fireguards should conform to BS 6539 (1984 Fireguards for use with solid fuel appliances). This fire is not fitted with an integral guard. In normal use consideration may be given to the use of a fireguard conforming to BS 6539, such that the approach to the naked flame is minimised.



It is very important that all the coals are used and arranged as shown in order to achieve the desired flame picture.

It may be necessary to remove some or all of the coals to clean them at some time. Cleaning must only be done using a soft brush.

CAUTION: The coals are extremely fragile and must be handled accordingly. Gloves should be worn and any inhalation of dust should be avoided. The coals must be kept away from children at all times. Never put additional coals on the fire. Never use coals other than those originally supplied, or genuine Legend Spare Parts.

1. Place the rear coal on the rear coal retainer ledge in a central position (Fig. 16).

2. Place the main fuel bed on to the middle section of the metal burner tray. It is important that the front edge of the fuel bed is located behind the burner strip (Fig. 17).

3. Position the front coal on the front coal retainer, making sure that the back edge is pushed up against the front of the burner strip (Fig. 18).

4. Place the side cheeks into position, making sure they are positioned either side of the fuel bed and the overhang is at the front. The outside edge should be in contact with the radiant box ceramic liner. Ensure that the lower part of the side cheeks sit on the front coal and are in front of the rear coal (Fig. 19).

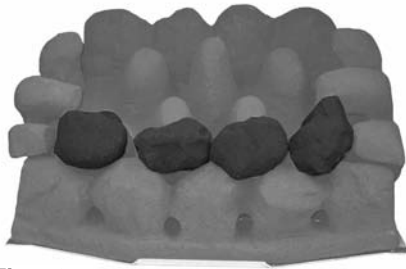

Fig. 20



Fig. 21

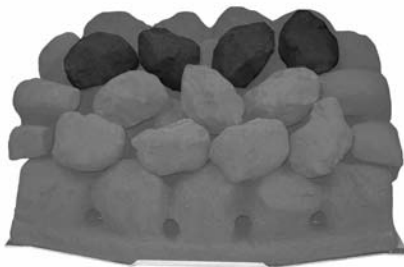

Fig. 22

5. Pick out the smallest two coals and lay to one side, lay the first row of four loose coals on top of the front coal. Ensure the back of the coals are resting on the coal bed and there are even gaps all round (Fig. 20).

6. Choose three loose coals and place them in line on the next row up, again making sure all the gaps are even. It is important that the coals 'bridge' the peaks of the fuel bed and are not placed in between. This helps the flow of burnt gases and should give an even glowing fuel bed (Fig. 21).

7. Lay another row of four coals on the next row up, again making sure all the gaps are even (Fig. 22).

8. Place the next three coals in the middle, on the back edge of the coals previously laid ensuring even gaps all round. Finally place the two small coals, one in each top corner. Make any adjustments necessary to achieve even gaps as this will help in giving a well balanced flame picture and an even glow (Fig. 23).

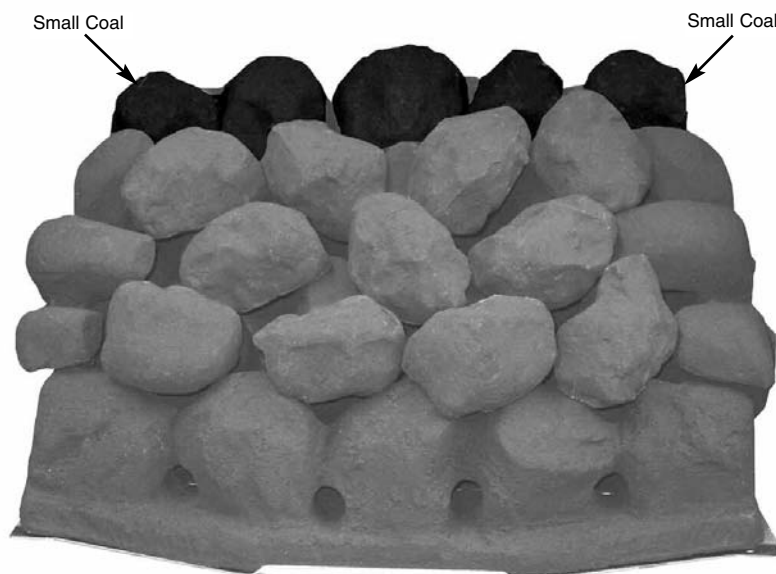

Fig. 23

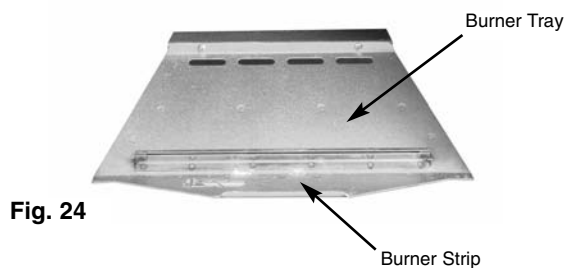

Fig. 24

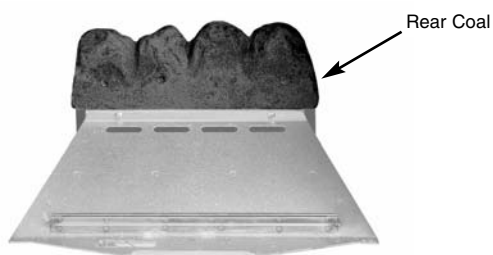

Fig. 25

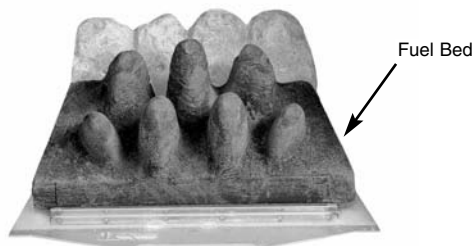

Fig. 26

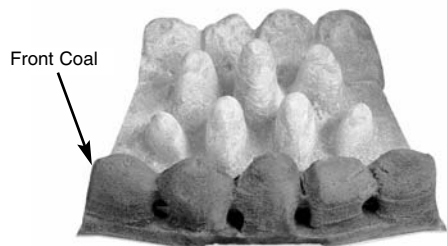

Fig. 27

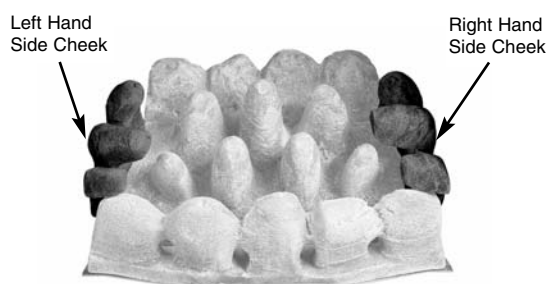

Fig. 28

It is very important that all the pebbles are used and arranged as shown in order to achieve the desired flame picture.

It may be necessary to remove some or all of the pebbles to clean them at some time. Cleaning must only be done using a soft brush.

CAUTION: The pebbles are extremely fragile and must be handled accordingly. Gloves should be worn and any inhalation of dust should be avoided. The pebbles must be kept away from children at all times. Never put additional pebbles on the fire. Never use pebbles other than those originally supplied, or genuine Legend Spare Parts.

1. Place the rear coal on the rear coal retainer ledge in a central position (Fig. 25).

2. Place the main fuel bed on to the middle section of the metal burner tray. It is important that the front edge of the fuel bed is located behind the burner strip (Fig. 26).

3. Position the front coal on the front coal retainer, making sure that the back edge is pushed up against the front of the burner strip (Fig. 27).

4. Place the side cheeks into position, making sure they are positioned either side of the fuel bed and the overhang is at the front. The outside edge should be in contact with the radiant box ceramic liner. Ensure that the lower part of the side cheeks sit on the front coal and are in front of the rear coal (Fig. 28).

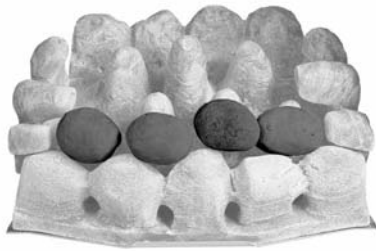

Fig. 29

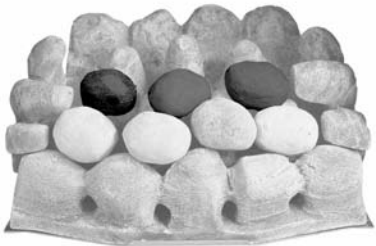

Fig. 30



Fig. 31

5. Pick out the smallest two pebbles and lay to one side, lay the first row of four loose pebbles on top of the front coal. Ensure the back of the pebbles are resting on the fuel bed and there are even gaps all round (Fig. 29).

6. Choose three loose pebbles and place them in line on the next row up, again making sure all the gaps are even. It is important that the pebbles 'bridge' the peaks of the fuel bed and are not placed in between. This helps the flow of burnt gases and should give an even glowing fuel bed (Fig. 30).

7. Lay another row of four pebbles on the next row up, again making sure all the gaps are even (Fig. 31).

8. Place the next three pebbles in the middle, on the back edge of the pebbles previously laid ensuring even gaps all round. Finally place the two small pebbles, one in each top corner. Make any adjustments necessary to achieve even gaps as this will help in giving a well balanced flame picture and an even glow (Fig. 32).

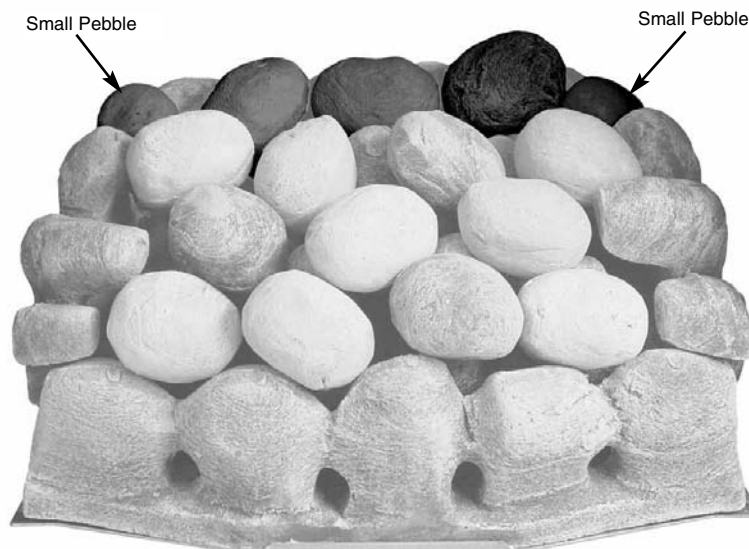
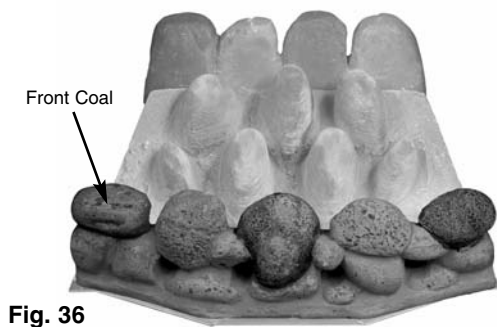
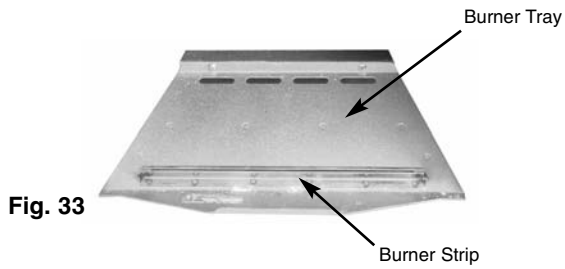

Fig. 32



It is very important that all the pebbles are used and arranged as shown in order to achieve the desired flame picture.

It may be necessary to remove some or all of the pebbles to clean them at some time. Cleaning must only be done using a soft brush.

CAUTION: The pebbles are extremely fragile and must be handled accordingly. Gloves should be worn and any inhalation of dust should be avoided. The pebbles must be kept away from children at all times. Never put additional pebbles on the fire. Never use pebbles other than those originally supplied, or genuine Legend Spare Parts.

1. Place the rear coal on the rear coal retainer ledge in a central position (Fig. 34).

2. Place the main fuel bed on to the middle section of the metal burner tray. It is important that the front edge of the fuel bed is located behind the burner strip (Fig. 35).

3. Position the front coal on the front coal retainer, making sure that the back edge is pushed up against the front of the burner strip (Fig. 36).

4. Place the side cheeks into position, making sure they are positioned either side of the fuel bed and the overhang is at the front. The outside edge should be in contact with the radiant box ceramic liner. Ensure that the lower part of the side cheeks sit on the front coal and are in front of the rear coal (Fig. 37).



5. Following Figs. 38 to 40, place the loose pebbles on to the fuel bed. It is important that the pebbles 'nest' together and sit on top of the fuel bed peaks.

6. Make any adjustments necessary to achieve even gaps as this will help in giving a well balanced flame picture and an even glow. After running the fire for 30 minutes, it may be necessary to adjust the pebbles with tongs.

Where possible, make sure that the flames do not play on the ceramic fire box liners, as this may cause sooting.

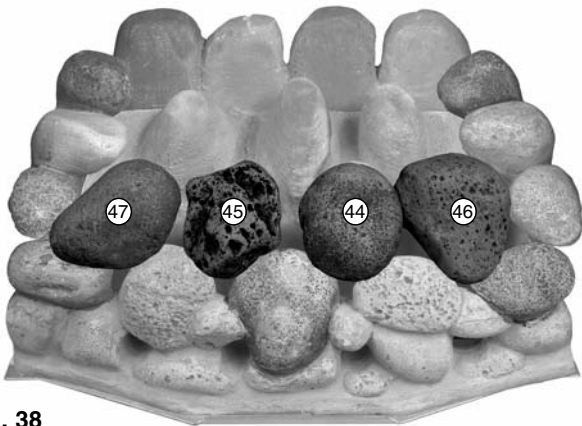

Fig. 38

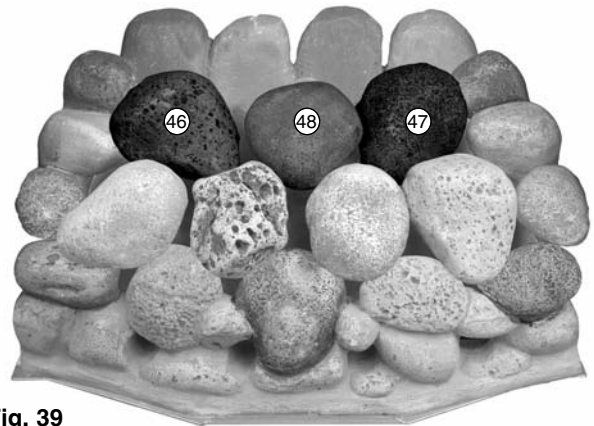

Fig. 39

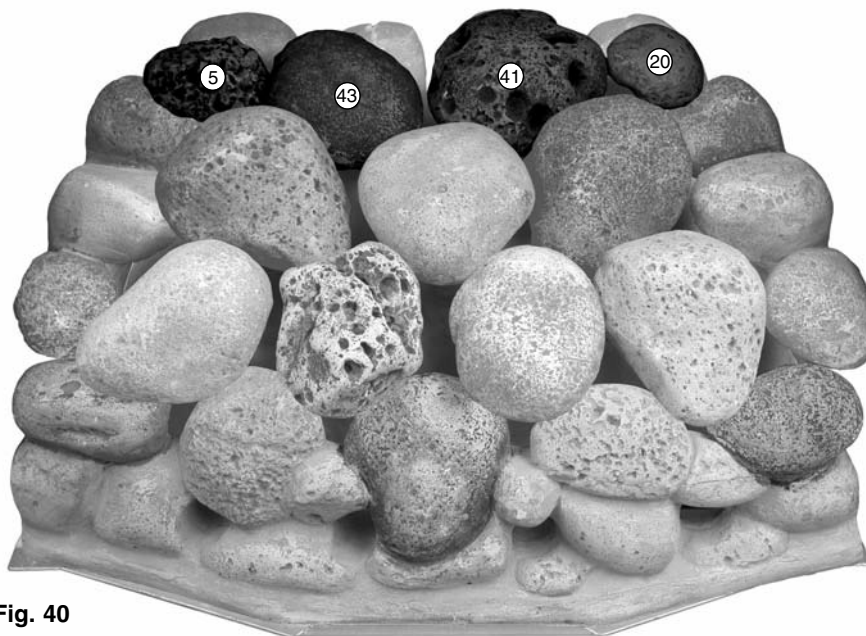

Fig. 40

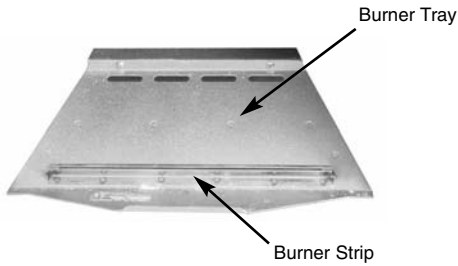

Fig. 41

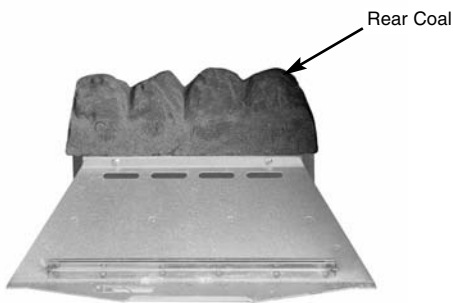

Fig. 42

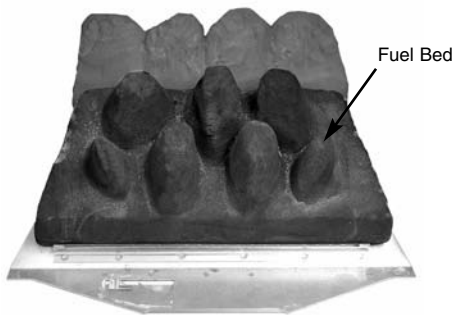

Fig. 43

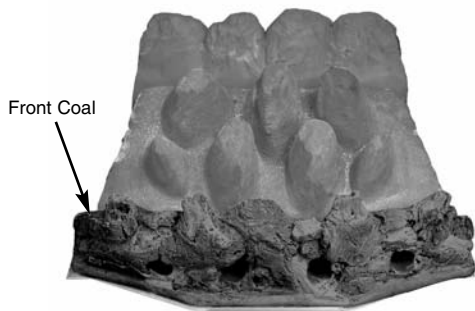

Fig. 44

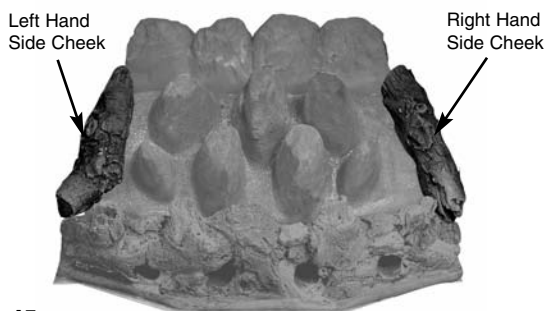

Fig. 45

It very is important that all the logs are used and arranged as shown in order to achieve the desired flame picture.

It may be necessary to remove some or all of the logs to clean them at some time. Cleaning must only be done using a soft brush.

CAUTION: The logs are extremely fragile and must be handled accordingly. Gloves should be worn and any inhalation of dust should be avoided. The logs must be kept away from children at all times. Never put additional logs on the fire. Never use logs other than those originally supplied, or genuine Legend Spare Parts.

1. Place the rear coal on the rear coal retainer ledge in a central position (Fig. 42).

2. Place the main fuel bed on to the middle section of the metal burner tray. It is important that the front edge of the fuel bed is located behind the burner strip (Fig. 43).

3. Position the front coal on the front coal retainer, making sure that the back edge is pushed up against the front of the burner strip (Fig. 44).

4. Place the side cheeks into position, making sure they are positioned either side of the fuel bed and the overhang is at the front. The outside edge should be in contact with the radiant box ceramic liner. Ensure that the lower part of the side cheeks sit on the front coal and are in front of the rear coal (Fig. 45).

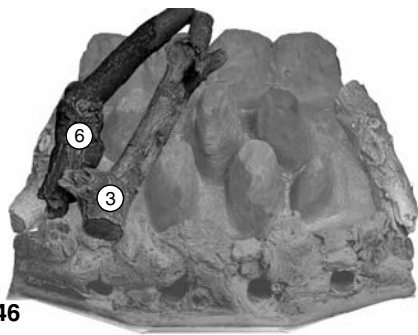

Fig. 46

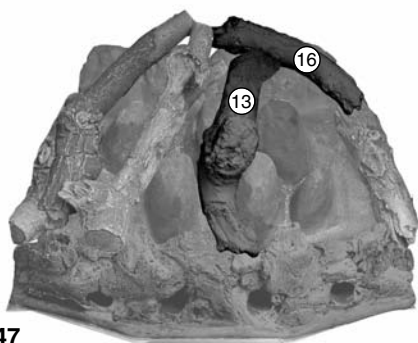

Fig. 47

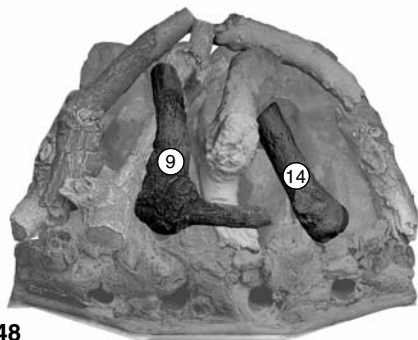

Fig. 48

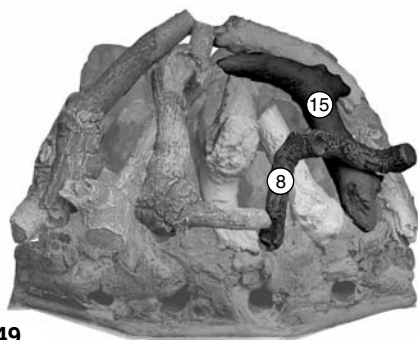

Fig. 49

5. Following Figs. 46 to 52, place the loose logs on to the fuel bed. It is important that the logs 'nest' together and sit on top of the fuel bed peaks.

6. Make any adjustments necessary to achieve even gaps as this will help in giving a well balanced flame picture and an even glow. After running the fire for 30 minutes, it may be necessary to adjust the logs with tongs.

Where possible, make sure that the flames do not play on the ceramic fire box liners, as this may cause sooting.

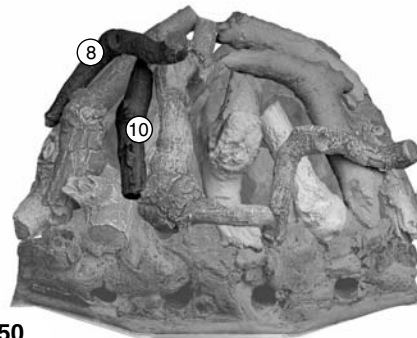

Fig. 50

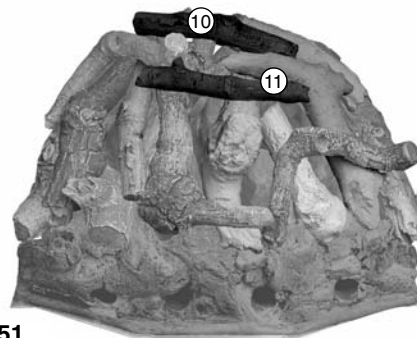

Fig. 51

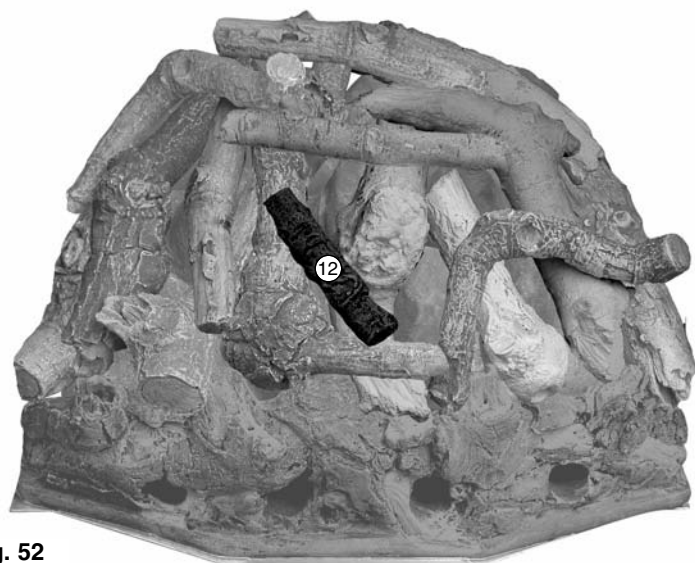

Fig. 52

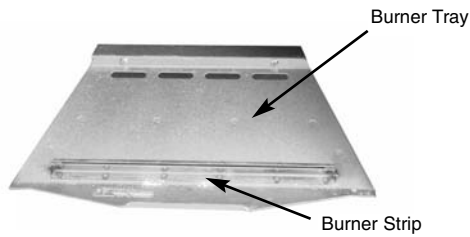

Fig. 53

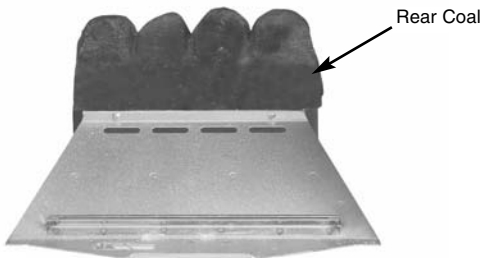

Fig. 54

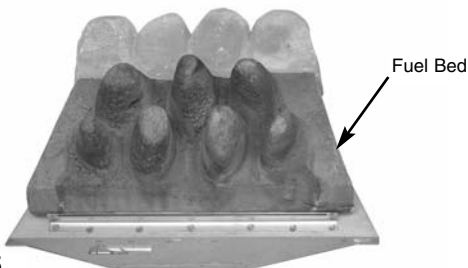

Fig. 55

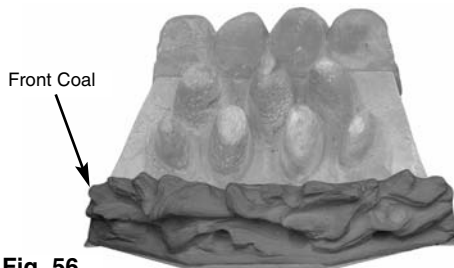

Fig. 56

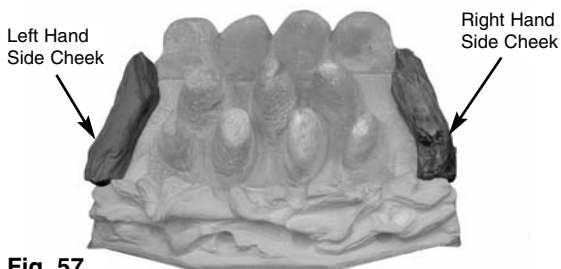

Fig. 57

It is very important that all the Driftwood is used and arranged as shown in order to achieve the desired flame picture.

It may be necessary to remove some or all of the Driftwood to clean them at some time. Cleaning must only be done using a soft brush.

CAUTION: The driftwood is extremely fragile and must be handled accordingly. Gloves should be worn and any inhalation of dust should be avoided. The driftwood must be kept away from children at all times. Never put additional driftwood on the fire. Never use driftwood other than that originally supplied, or genuine Legend Spare Parts.

1. Place the rear coal on the rear coal retainer ledge in a central position (Fig. 54).

2. Place the main fuel bed on to the middle section of the metal burner tray. It is important that the front edge of the fuel bed is located behind the burner strip (Fig. 55).

3. Position the front coal on the front coal retainer, making sure that the back edge is pushed up against the front of the burner strip (Fig. 56).

4. Place the side cheeks into position, making sure they are positioned either side of the fuel bed and the overhang is at the front. The outside edge should be in contact with the radiant box ceramic liner. Ensure that the lower part of the side cheeks sit on the front coal and are in front of the rear coal (Fig. 57).

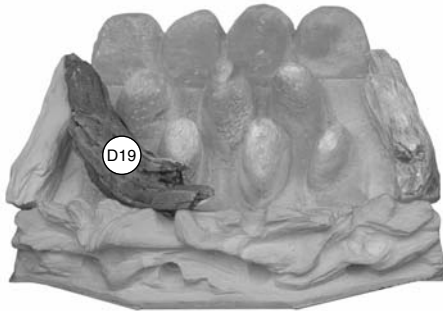

Fig. 58

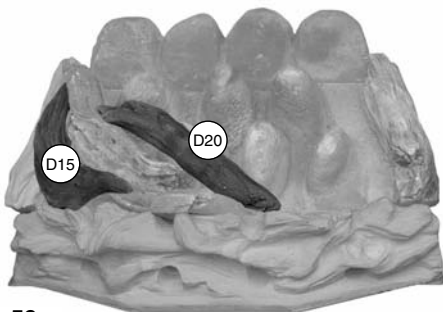

Fig. 59

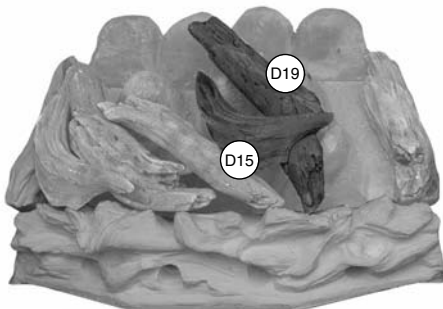

Fig. 60

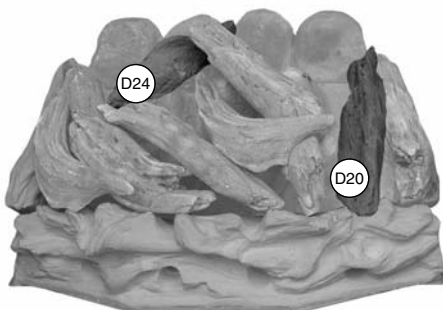

Fig. 61

6. Following Figs. 58 to 64, place the loose driftwood pieces onto the fuel bed. It is important that the driftwood 'nests' together and sits on top of the fuel bed peaks.

7. Make sure all the gaps are even in order to obtain a balanced flame picture and efficient combustion.

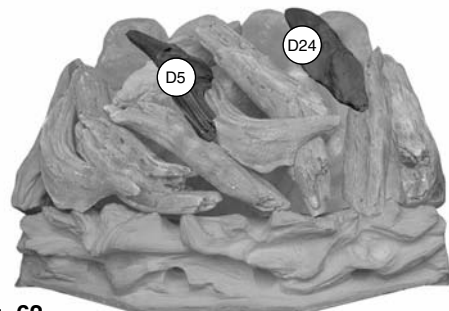

Fig. 62

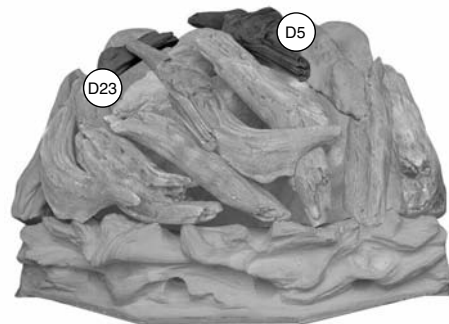

Fig. 63



Fig. 64



CAUTION: The coals are extremely fragile and must be handled accordingly. Gloves should be worn and any inhalation of dust should be avoided. Never put additional coals on the fire. Never use coals other than those originally supplied, or genuine Legend Spare Parts.

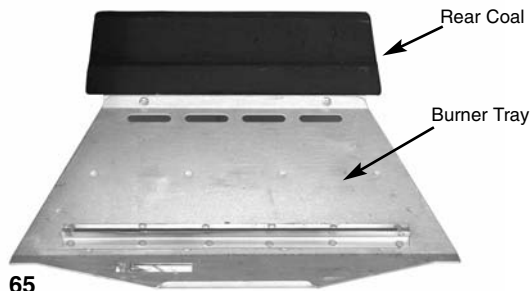

Fig. 65

1. Place the rear coal on the rear coal retainer ledge in a central position, ensuring the step portion is facing the front (Fig. 65).

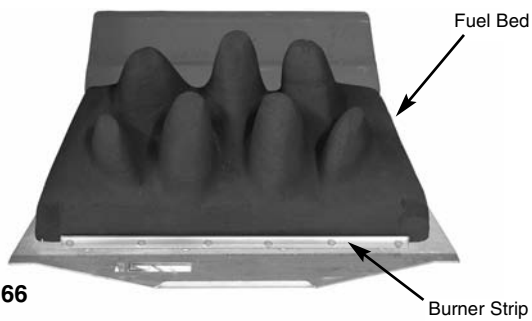

Fig. 66

2. Place the main fuel bed on to the middle section of the metal burner tray. It is important that the front edge of the fuel bed is located behind the burner strip (Fig. 66).



Fig. 67

3. Position the front coal piece on the front coal retainer, making sure that the back edge is pushed up against the front of the burner strip. Ensure that the lugs on the rear of the front coal are located at either end of the burner strip (Fig. 67).

4. Locate the remaining coal pieces in order as shown in Figs. 68 to 71.



Fig. 68



Fig. 69



Fig. 70

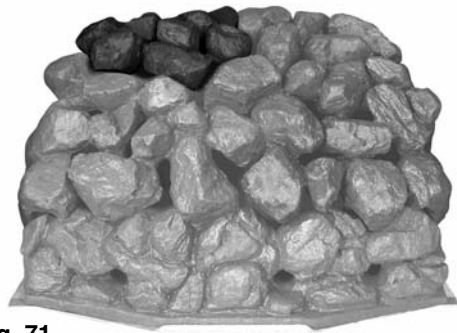

Fig. 71

5. Finally check that all the coal pieces are 'nested' together correctly (Fig. 72).

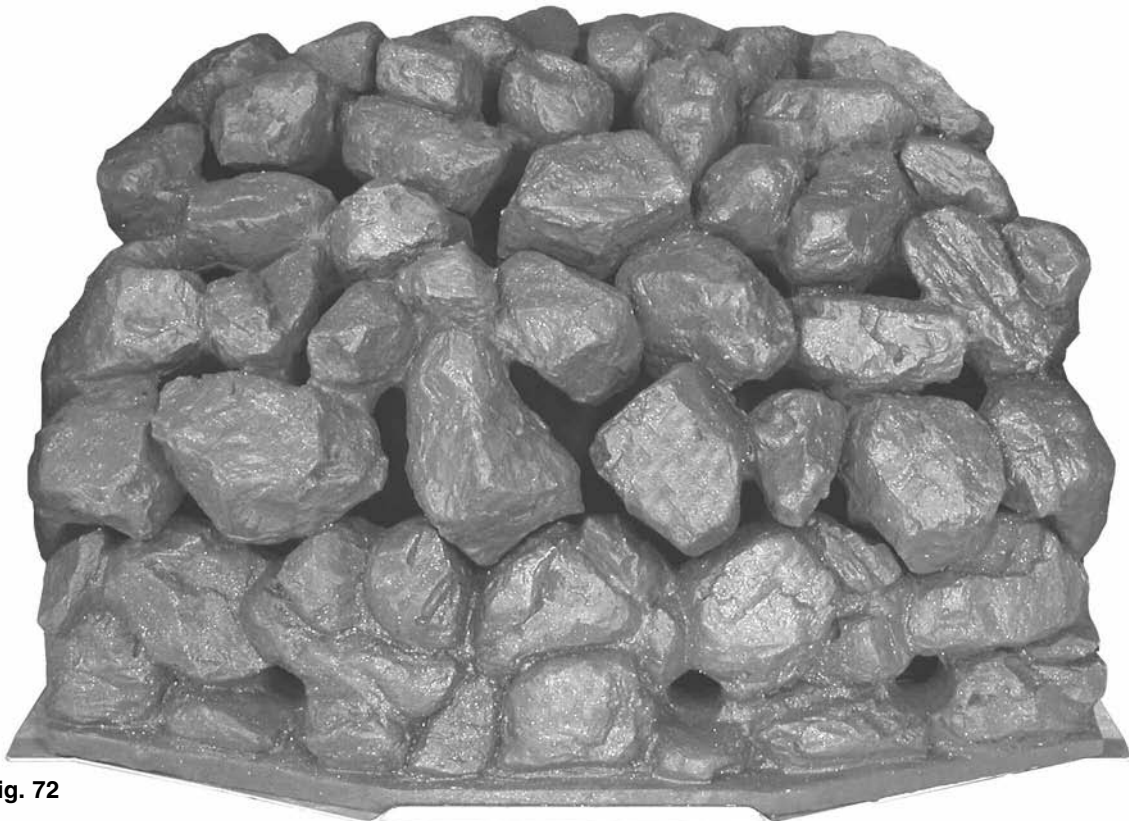

Fig. 72

It is very important that all the coals are used and arranged as shown in order to achieve the desired flame picture.

It may be necessary to remove some or all of the coals to clean them at some time. Cleaning must only be done using a soft brush.

Ceramic touch-up dye is available from Legend Fires.



CAUTION: The pebbles are extremely fragile and must be handled accordingly. Gloves should be worn and any inhalation of dust should be avoided. Never put additional pebbles on the fire. Never use pebbles other than those originally supplied, or genuine Legend Spare Parts.

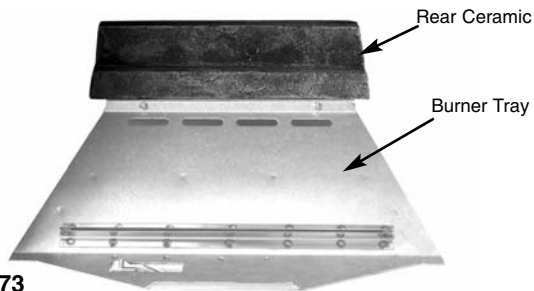

Fig. 73

1. Place the rear ceramic on the rear ceramic retainer ledge in a central position, ensuring the step portion is facing the front (Fig. 73).

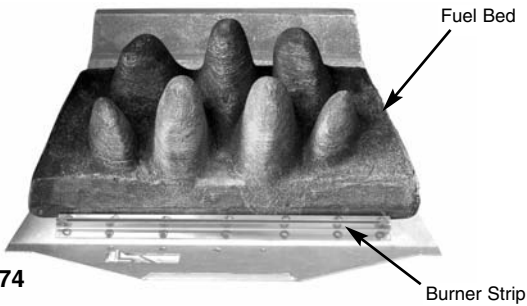

Fig. 74

2. Place the main fuel bed on to the middle section of the metal burner tray. It is important that the front edge of the fuel bed is located behind the burner strip (Fig. 74).



Fig. 75

3. Position the front pebble piece on the front ceramic retainer, making sure that the back edge is pushed up against the front of the burner strip. Ensure that the lugs on the rear of the front pebble are located at either end of the burner strip (Fig. 75).

4. Locate the remaining pebble pieces in order as shown in Figs. 76 to 79.



Fig. 76



Fig. 77



Fig. 78



Fig. 79

5. Finally check that all the pebble pieces are 'nested' together correctly (Fig. 80).

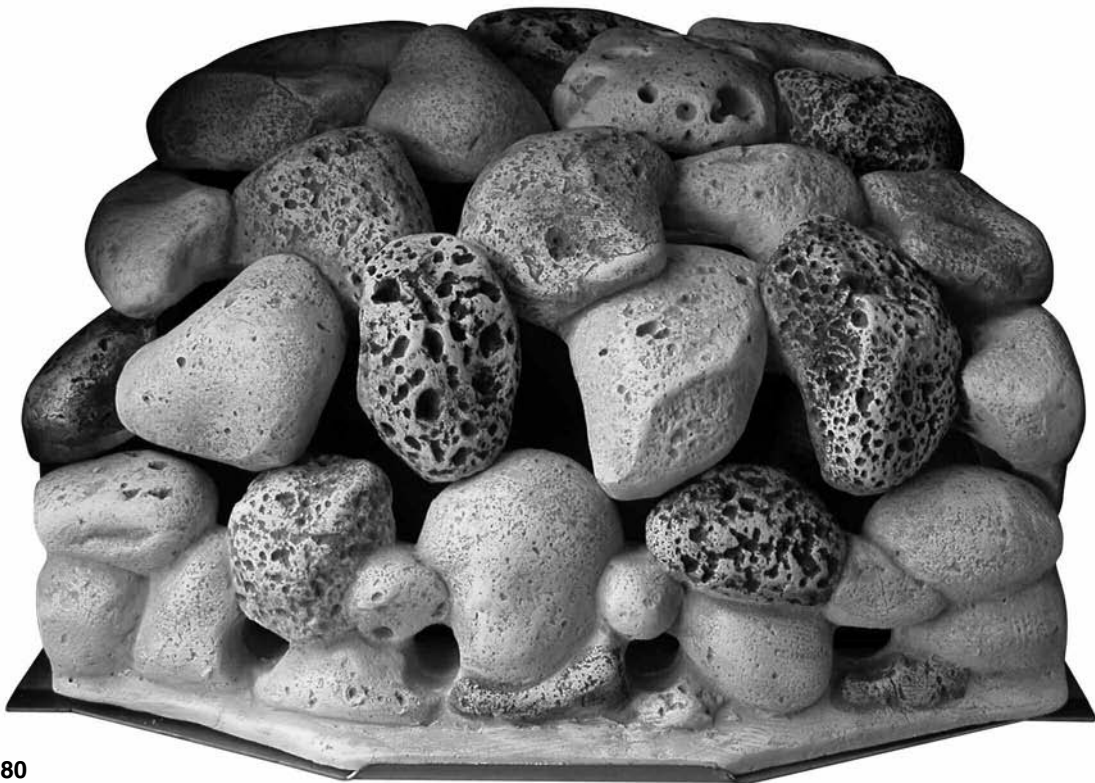

Fig. 80

It is very important that all the pebbles are used and arranged as shown in order to achieve the desired flame picture.

It may be necessary to remove some or all of the pebbles to clean them at some time. Cleaning must only be done using a soft brush. Ceramic touch-up dye is available from Legend Fires.

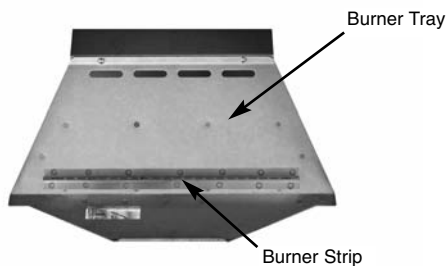

Fig. 81

This ceramic ripped coal set is for use on Natural Gas appliances only.

It very is important that all the coals are used and arranged as shown in order to achieve the desired flame picture.

It may be necessary to remove some or all of the coals to clean them at some time. Cleaning must only be done using a soft brush.

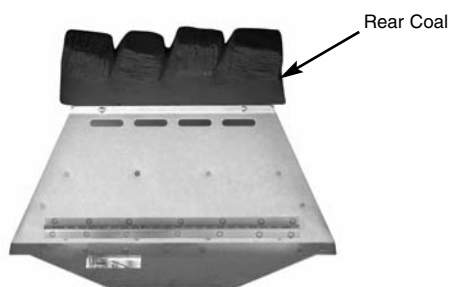

Fig. 82

CAUTION: The coals are extremely fragile and must be handled accordingly. Gloves should be worn and any inhalation of dust should be avoided. The coals must be kept away from children at all times. Never put additional coals on the fire. Never use coals other than those originally supplied, or genuine Legend Spare Parts.

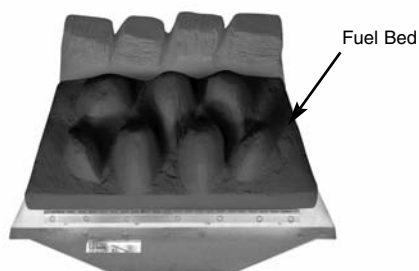

Fig. 83

1. Place the rear coal on the rear coal retainer ledge in a central position (Fig. 82).

2. Place the main fuel bed on to the middle section of the metal burner tray. It is important that the front edge of the fuel bed is located behind the burner strip (Fig. 83).

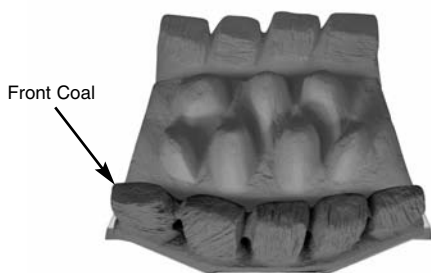

Fig. 84

3. Position the front coal on the front coal retainer, making sure that the back edge is pushed up against the front of the burner strip (Fig. 84).



Fig. 85

4. Place the side cheeks into position, making sure they are positioned either side of the fuel bed and the overhang is at the front. The outside edge should be in contact with the radiant box ceramic liner. Ensure that the lower part of the side cheeks sit on the front coal and are in front of the rear coal (Fig. 85).



Fig. 86

5. Following Figs. 86 to 89, place the loose coals on to the fuel bed. It is important that the coals 'nest' together and sit on top of the fuel bed peaks.

6. Make any adjustments necessary to achieve even gaps as this will help in giving a well balanced flame picture and an even glow. After running the fire for 30 minutes, it may be necessary to adjust the coals with tongs.

Where possible, make sure that the flames do not play on the ceramic fire box liners, as this may cause sooting.



Fig. 87



Fig. 88



Fig. 89

GUARANTEE



Your appliance is guaranteed for one year from proof of purchase. Should the appliance prove defective within that period we agree to repair or replace (at our discretion) the component or appliance provided that:

1. The user can produce a receipt for proof of purchase/installation.
2. The appliance has been supplied by an authorised stockist and has been installed by a qualified installer, all installation and operating instructions have been strictly adhered to.
3. No alterations have been carried out on the appliance or component parts without our written consent.
4. The appliance has not been used for any purpose other than those intended.
5. The appliance has not been damaged accidentally or due to fair wear and tear.

Guarantee claims should be made through your appliance supplier. The Guarantee is restricted to UK Mainland and is additional to your statutory rights.

TROUBLE SHOOTING (USER)

1. The Fire will not light.

Ensure the remote handset is fitted with a working battery. Make sure the bulbous side of the I.R. is facing towards the front. The controls are powered by a lithium battery pack. When the battery power is becoming low a beeping sound will continue every time you use the fire. Please contact your supplier if you require a new lithium battery pack. Remove the brass fret and check the pilot area for soot. If soot is present remove all the loose coals and the front coal and thoroughly clean any debris in and around the pilot area. If the fire will still not light contact your installer.

2. The flames appear blue - excessive soot deposits.

The ceramic components including the coal need relaying (pages 16-31). Too much or too little room ventilation. Seek professional advice.

3. Roaring noise coming from the pilot.

The front coal is not seated correctly. Turn the appliance off and allow to cool down. Re-seat front coal, ensuring it is flat to the base of the front coal retainer (pages 16, 18, 20, 22, 24, 26, 28 & 30).

4. All the Ceramic Components are discolouring.

The ceramic sets and liners are all manufactured from ceramic fibre and its natural colour is white, dyes are used to give it a realistic appearance. These dyes discolour after they have been subjected to intense heat. However the discolouration does not affect the operation of the appliance. The realistic appearance can be restored with the use of a good replacement dye that can be purchased from most good fireplace showrooms.

Legendfires 

Unit 200
Glenfield Park Site 1
Philips Road
Blackburn
Lancashire
BB1 5PF

Tel: 01254 695244

Fax: 01254 695255

Web: www.legend-fires.com

Email: info@legend-fires.com

OP031 - Issue 11b - 23/03/11