

3-Phase Hybrid Inverter  
User Manual

**SH5.0RT / SH6.0RT / SH8.0RT / SH10RT**





# All Rights Reserved

## All Rights Reserved

No part of this document can be reproduced in any form or by any means without the prior written permission of Sungrow Power Supply Co., Ltd.(hereinafter "SUNGROW").

## Trademarks

**SUNGROW** and other Sungrow trademarks used in this manual are owned by Sungrow Power Supply Co., Ltd.

All other trademarks or registered trademarks mentioned in this document are owned by their respective owners.

## Software Licenses

- It is prohibited to use data contained in firmware or software developed by SUNGROW, in part or in full, for commercial purposes by any means.
- It is prohibited to perform reverse engineering, cracking, or any other operations that compromise the original program design of the software developed by SUNGROW.

Sungrow Power Supply Co., Ltd.

Address: **No.1699 Xiyou Rd., New & High Tech Zone, Hefei, 230088, China.**

Email: **info@sungrow.cn**

Tel: +86 551 6532 7834

Website: **www.sungrowpower.com**

# About This Manual

The manual mainly describes the product information, guidelines for installation, operation and maintenance. The manual cannot include complete information about the photovoltaic (PV) system. The reader can get additional information about other devices at [www.sungrowpower.com](http://www.sungrowpower.com) or on the webpage of the respective component manufacturer.

## Validity

This manual is valid for the following inverter models:

- SH5.0RT
- SH6.0RT
- SH8.0RT
- SH10RT

They will be referred to as “inverter” hereinafter unless otherwise specified.

## Target Group

This manual is intended for:

- qualified personnel who are responsible for the installation and commissioning of the inverter; and
- inverter owners who will have the ability to interact with the inverter.




## How to Use This Manual

Read the manual and other related documents before performing any operation on the inverter. Documents must be stored carefully and be available at all times.


Contents may be periodically updated or revised due to product development. The information in this manual is subject to change without notice. The latest manual can be acquired at <http://support.sungrowpower.com/>.

## Symbols

Safety instructions will be highlighted with the following symbols.

Symbol	Explanation
 <b>DANGER</b>	Indicates a hazard with a high level of risk that, if not avoided, will result in death or serious injury.
 <b>WARNING</b>	Indicates a hazard with a medium level of risk that, if not avoided, could result in death or serious injury.
 <b>CAUTION</b>	Indicates a hazard with a low level of risk that, if not avoided, could result in minor or moderate injury.



Symbol	Explanation
<b>NOTICE</b>	Indicates a situation that, if not avoided, could result in equipment or property damage.
	Indicates additional information, emphasized contents or tips that may be helpful, e.g. to help you solve problems or save time.



# Contents

---

All Rights Reserved .....	I
About This Manual .....	II
<b>1 Safety</b> .....	1
1.1 PV Panels .....	1
1.2 Utility Grid .....	1
1.3 Inverter .....	2
1.4 Batteries .....	3
1.5 Skills of Qualified Personnel .....	4
<b>2 System Solution</b> .....	5
2.1 Product Introduction .....	5
2.1.1 Model Description .....	5
2.1.2 Appearance .....	6
2.1.3 Dimensions .....	6
2.1.4 LED Indicator .....	6
2.1.5 DC Switch .....	7
2.2 PV Energy Storage System (PV ESS) .....	7
2.3 Retrofitting the Existing PV System .....	11
<b>3 Function Description</b> .....	13
3.1 Safety Function .....	13
3.1.1 Protection .....	13
3.1.2 Earth Fault Alarm .....	13
3.2 Energy Conversion and Management .....	13
3.2.1 Power Derating .....	13
3.2.2 DRM ( “ AU ” / “ NZ ” ) .....	14
3.2.3 Regular Operational Voltage Range .....	14
3.2.4 Regular Operational Frequency Range .....	15
3.2.5 Reactive Power Regulation .....	15
3.2.6 Load Control .....	15
3.3 Battery Management .....	15
3.3.1 Charge Management .....	16
3.3.2 Discharge Management .....	17

3.4 Communication and Configuration .....	18
<b>4 Unpacking and Storage .....</b>	<b>19</b>
4.1 Unpacking and Inspection .....	19
4.2 Identifying the Inverter .....	19
4.3 Scope of Delivery .....	21
4.4 Inverter Storage .....	21
<b>5 Mechanical Mounting .....</b>	<b>23</b>
5.1 Safety during Mounting .....	23
5.2 Location Requirements .....	23
5.2.1 Installation Environment Requirements .....	23
5.2.2 Carrier Requirements .....	24
5.2.3 Installation Angle Requirements .....	24
5.2.4 Installation Clearance Requirements .....	24
5.3 Installation Tools .....	25
5.4 Moving the Inverter .....	26
5.5 Installing the Inverter .....	27
<b>6 Electrical Connection .....</b>	<b>29</b>
6.1 Safety Instructions .....	29
6.2 Terminal Description .....	29
6.3 Electrical Connection Overview .....	31
6.4 Additional Grounding Connection .....	34
6.4.1 Additional Grounding Requirements .....	34
6.4.2 Connection Procedure .....	34
6.5 AC Cable Connection .....	35
6.5.1 AC Side Requirements .....	35
6.5.2 Assembling the AC Connector .....	36
6.5.3 Installing the AC Connector .....	37
6.6 DC Cable Connection .....	39
6.6.1 PV Input Configuration .....	40
6.6.2 DC Side Requirements .....	41
6.6.3 Assembling the PV Connector .....	41
6.6.4 Installing the PV Connector .....	42
6.7 Communication Connection .....	43
6.7.1 Ethernet Connection .....	44
6.7.2 WLAN Connection .....	46
6.7.3 RS485 Connection .....	47

6.8 Smart Energy Meter Connection.....	49
6.9 Battery Connection.....	50
6.9.1 Connecting the Power Cable.....	50
6.9.2 Connecting the CAN Cable .....	52
6.9.3 Connecting the Enable Cable.....	52
6.10 DO Connection.....	53
6.11 DI/DRM Connection .....	54
6.11.1 Assembling the COM Connector.....	55
6.11.2 Installing the COM Connector .....	57
6.12 Backup Connection.....	58
<b>7 Commissioning .....</b>	<b>60</b>
7.1 Inspection before Commissioning.....	60
7.2 Commissioning Procedure .....	60
<b>8 iSolarCloud App .....</b>	<b>61</b>
8.1 Brief Introduction.....	61
8.2 Download and Install.....	61
8.3 Login .....	62
8.3.1 Requirements.....	62
8.3.2 Login Steps .....	62
8.4 Initial Settings.....	64
8.4.1 Feed-in Limitation.....	64
8.4.2 Off-grid Mode .....	64
8.4.3 Reactive Power Regulation Mode .....	64
8.5 Function Overview .....	67
8.6 Home.....	68
8.7 Run Information .....	69
8.8 Records .....	70
8.8.1 Chart.....	70
8.8.2 Fault Alarm Record.....	71
8.9 More.....	71
8.9.1 System Parameters .....	72
8.9.2 Running Time .....	73
8.9.3 Regular Parameters.....	73
8.9.4 Off-grid Parameters.....	74
8.9.5 Active Power Regulation .....	74
8.9.6 Reactive Power Regulation .....	75

8.9.7 Battery Discharge Time.....	75
8.9.8 Battery Forced Charge Time .....	76
8.9.9 Load Regulation .....	76
8.9.10 Communication Parameters .....	78
8.9.11 Firmware Update.....	79
8.9.12 Grounding Detection.....	80
<b>9 System Decommissioning .....</b>	<b>81</b>
9.1 Decommissioning the Inverter .....	81
9.1.1 Disconnecting the Inverter .....	81
9.1.2 Dismantling the Inverter .....	82
9.1.3 Disposal of the Inverter .....	82
9.2 Decommissioning the Battery .....	83
<b>10 Troubleshooting and Maintenance .....</b>	<b>84</b>
10.1 Troubleshooting .....	84
10.2 Maintenance .....	89
10.2.1 Routine Maintenance.....	89
10.2.2 Replacing the Button Cell.....	90
<b>11 Appendix .....</b>	<b>91</b>
11.1 Technical Data .....	91
11.2 Quality Assurance .....	95
11.3 Contact Information .....	96

# 1 Safety

The inverter has been designed and tested strictly according to international safety regulations. Read all safety instructions carefully prior to any work and observe them at all times when working on or with the inverter.

Incorrect operation or work may cause:

- injury or death to the operator or a third party;
- damage to the inverter and other properties.

All detailed work-related safety warnings and notes will be specified at critical points in corresponding chapters.



- The safety instructions in this manual cannot cover all the precautions that should be followed. Perform operations considering actual onsite conditions.
- SUNGROW shall not be held liable for any damage caused by violation of the safety instructions in this manual.

## 1.1 PV Panels

### DANGER

PV strings will produce electrical power when exposed to sunlight and can cause a lethal voltage and an electric shock.

- Always keep in mind that the inverter is dual power supplied. Electrical operators must wear proper personal protective equipment: helmet, insulated footwear, gloves, etc.
- Before touching the DC cables, operator must use a measuring device to ensure that the cable is voltage-free.
- The operator must follow all warnings on the PV strings and in its manual.

## 1.2 Utility Grid

Follow the regulations related to the utility grid.

**NOTICE**

All electrical connections must be in accordance with local and national standards.

Only with the permission of the local utility grid company, the inverter can be connected to the utility grid.

## 1.3 Inverter

**⚠ DANGER**

Danger to life from electric shocks due to live voltage

- Do not open the enclosure at any time. Unauthorized opening will void warranty and warranty claims and in most cases terminate the operating license.

**⚠ WARNING**

Risk of inverter damage or personal injury.

- Do not disconnect the PV connectors or battery connectors when the inverter is running.
- Wait at least 10 minutes for the internal capacitors to discharge after the battery is powered off. Ensure that there is no voltage or current before disconnecting any connectors.

**⚠ WARNING**

All safety instructions, warning labels, and nameplate on the inverter:

- Must be clearly legible.
- Should not be removed or covered.

**⚠ CAUTION**

Risk of burns due to hot components!

Do not touch any hot parts (such as the heat sink) during operation. Only the DC switch can safely be touched at any time.



**NOTICE**

Only qualified personnel can perform the country setting. Unauthorized alteration may cause:






- A breach of the type-certificate marking.

Risk of inverter damage due to electrostatic discharge (ESD) !

By touching the electronic components, you may damage the inverter. For inverter handling, be sure to:

- avoid any unnecessary touching;
- wear a grounding wristband before touching any connectors.

**Warning Label**

Label	Description
	Disconnect the inverter from all the external power sources before maintenance!
	Do not touch live parts for 10 minutes after disconnection from the power sources.
	Burn danger due to hot surface that may exceed 60 °C.
	Danger to life due to high voltages! Only qualified personnel can open and maintain the inverter.
	Read the user manual before maintenance!

**1.4 Batteries****⚠ DANGER**

Batteries deliver electric power, resulting in burns or a fire hazard when they are short circuited, or wrongly installed.

Lethal voltages are present at the battery terminals and cables connecting to the inverter. Severe injuries or death may occur if the cables and terminals in the inverter are touched.

**NOTICE**

Improper settings or maintenance can permanently damage the battery. Incorrect inverter parameters will lead to the premature aging of battery.

## 1.5 Skills of Qualified Personnel

All installations must be performed by qualified personnel who should have:

- Training for installation and commissioning of electrical system, as well as dealing with hazards
- Knowledge of the manual and other related documents
- Knowledge of the local regulations and directives

## 2 System Solution

### ⚠ WARNING

The inverter must only be operated with PV strings with class II protection in accordance with IEC 61730, application class A. It is not allowed for the positive pole or the negative pole of the PV strings or battery to be grounded. This can cause the inverter to be destroyed.

Damages to the product due to a faulty or damaged PV installation are not covered by warranty.

Any use other than the one described in this document is not permitted.

### NOTICE

For the TT utility grid, the N line voltage to ground must be 30 V or less.

The three-phase hybrid inverters are applicable to both on-grid and off-grid PV systems. With the integrated Energy Management System (EMS), they can control and optimize the energy flow so as to increase the self-consumption of the system.

## 2.1 Product Introduction

### 2.1.1 Model Description

The model description is as follows (Take SH10RT as an example):

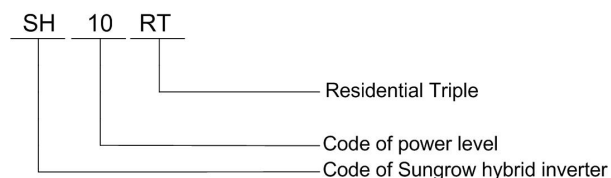


Table 2-1 Power Level Description

Model	Nominal Output Power	Nominal Grid Voltage
SH5.0RT	5000 W	3 / N / PE, 230 / 400 V
SH6.0RT	6000 W	
SH8.0RT	8000W	
SH10RT	10000W	

## 2.1.2 Appearance

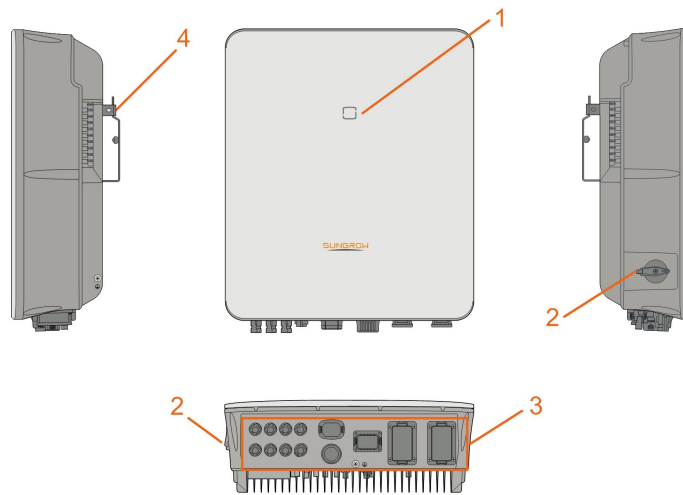


Figure 2-1 Appearance

\* The image shown here is for reference only. The actual product received may differ.

No.	Name	Description
1	LED indicator panel	Indicates the current working state of the inverter.
2	DC switch	Used to safely disconnect the DC circuit.
3	Electrical connection area	Includes DC terminals, AC terminals, battery terminals, communication terminals and additional grounding terminal.
4	Hanger	Used to hang the inverter on the wall-mounting bracket.

## 2.1.3 Dimensions

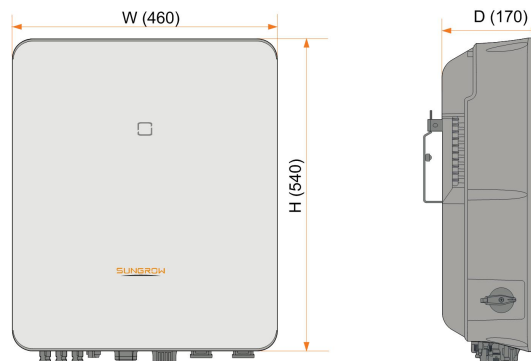





Figure 2-2 Dimensions of the inverter (in mm)

## 2.1.4 LED Indicator

The LED indicator on the front of the inverter can indicate the current working state of the inverter.

Table 2-2 LED indicator description

LED indicator	LED state	Definition
	ON	The inverter is running in the on/off-grid mode.
	Twinkling	The inverter is at standby or startup state (- without on/off-grid operation).
	ON	The inverter is running in the mode instead of on/off-grid mode. A system fault has occurred.
	OFF	Both the AC and DC sides are powered down.

### 2.1.5 DC Switch

The DC switch is used to safely disconnect the DC circuit whenever necessary.

The inverter operates automatically when input and output requirements are met. Rotate the DC switch to the “OFF” position to stop the inverter when a fault occurs or when you need to stop the inverter.



Turn the DC switch to the “ON” position before restarting the inverter.

## 2.2 PV Energy Storage System (PV ESS)

By directly connecting a battery module to the inverter, the conventional PV system can be upgraded to be an Energy Storage System (ESS).

The system is capable of operating off-grid to ensure an emergency power supply for protected loads in the event of a grid interruption or blackout, which may be caused by:

- islanding;
- under-voltage or over-voltage;
- under-frequency or over-frequency.

**NOTICE**

For the TT utility grid, the N line voltage to ground must be 30 V or less. The utility grid must be a TN system for the off-grid application. Especially when the utility grid is TN-C system, N line and PE line need to be short circuited externally when the inverter works as off-grid application. The system is not suitable for supplying life-sustaining medical devices. It cannot guarantee backup power in all circumstances.

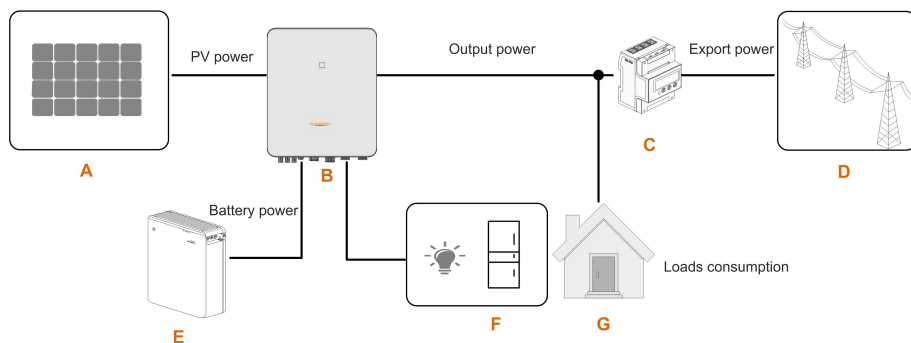


Figure 2-3 PV Energy Storage System (PV ESS)

Table 2-3 System Compositions

Item	Description	Remark
A	PV strings	Compatible with monocrystalline silicon, polycrystalline silicon, and thin-film without grounding.
B	Inverter	SH5.0RT / SH6.0RT / SH8.0RT / SH10RT
C	Three-phase Smart Energy Meter	Measures the export power and communicates with the inverter via the RS485 port.
D	Utility grid	Grid grounding system types: TT, TN
E	Battery (optional)	A Li-ion battery
F	Backup loads	Protected house loads directly connected to the inverter.
G	Normal Loads	Non protected house loads, they will disconnect in case of grid failure.

### Declaration For Back-Up Function

The following statement involves SUNGROW general policies about the hybrid inverters described in this document.

- 1 For hybrid inverters, the electrical installation typically includes connection of the inverter to both PV modules and batteries. If there is no available power from batteries or PV modules in backup mode, the backup power supply will be

automatically terminated. SUNGROW shall hold no liability for any consequences arising from failing to observe this instruction.

- 2 Normally, the Back-Up switching time is less than 20ms. However, some external factors may cause the system to fail on Back-Up mode. Therefore, the users must be aware of conditions and follow the instructions as below:
  - Do not connect loads that are dependent on a stable energy supply for a reliable operation.
  - Do not connect the loads whose total capacity is greater than the maximum Back-Up capacity.
  - Do not connect the loads that may cause very high start-up current surges, such as air-conditioner, high-power pump, and hair drier.
  - Due to the condition of the battery itself, battery current might be limited by some factors, including but not limited to the temperature and weather.

#### **Declaration For Back-Up Overload Protection**

The inverter will restart in case of overload protection. The time required for restarting will increase (5min at most) if overload protection repeats. Try to reduce Back-Up load power within maximum limitation or remove the loads which may cause very high start-up current surges.

#### **Energy Management**

The battery discharges to provide energy to loads. If the battery is empty or there is not enough power from the battery system, the grid shall supply the power, first to Backup loads, then normal loads.

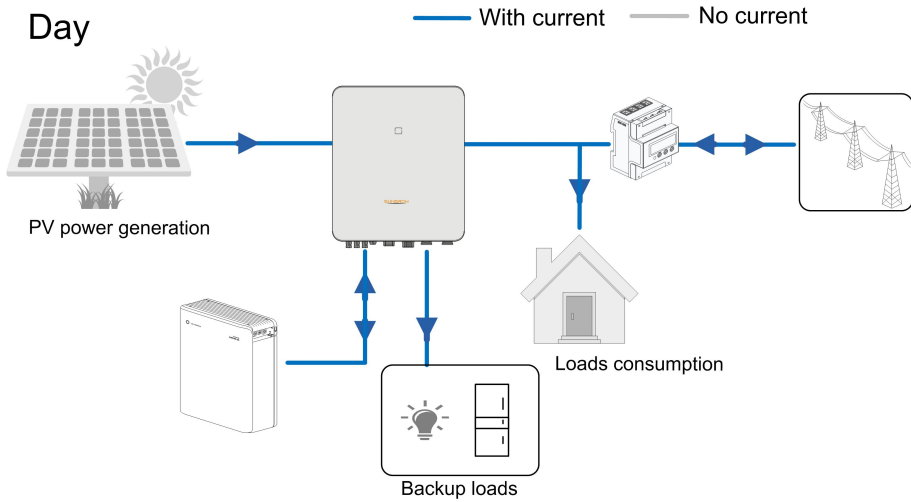
When the grid is present, the bypass function of the hybrid inverter is activated and the Backup loads will be directly connected to the grid via the bypass switch integrated in the inverter.

If the Smart Energy Meter is abnormal or not equipped, the inverter will run normally, however, the battery can be charged but not allowed to discharge. In this case the feed-in power setting will be ineffective, and the DO function for optimized mode will be disabled.

#### **Energy Management during Daytime**

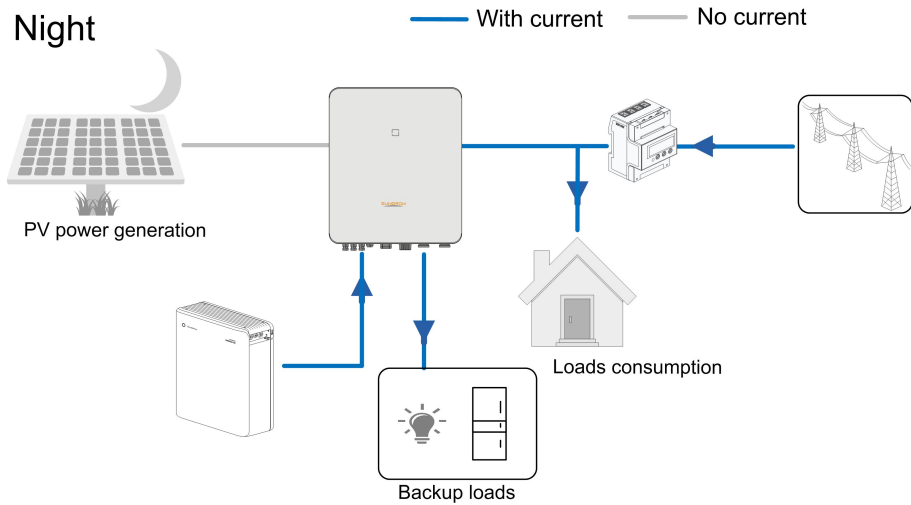
The energy management system (EMS) works in self-consumption mode by default.

- Scenario 1: PV power generation  $\geq$  Load power consumption
  - First, PV power will go to Backup loads first, then normal loads and the battery.
  - Moreover, If the battery is fully charged, the excess will go to the grid. The feed-in power will not surpass the feed-in limitation value in initial settings.
- Scenario 2: PV power generation  $<$  Load power consumption
  - First, battery will discharge and provide the energy missing.
  - Moreover, inverter will draw power from the mains if the power from the PV and battery is less than the load power.



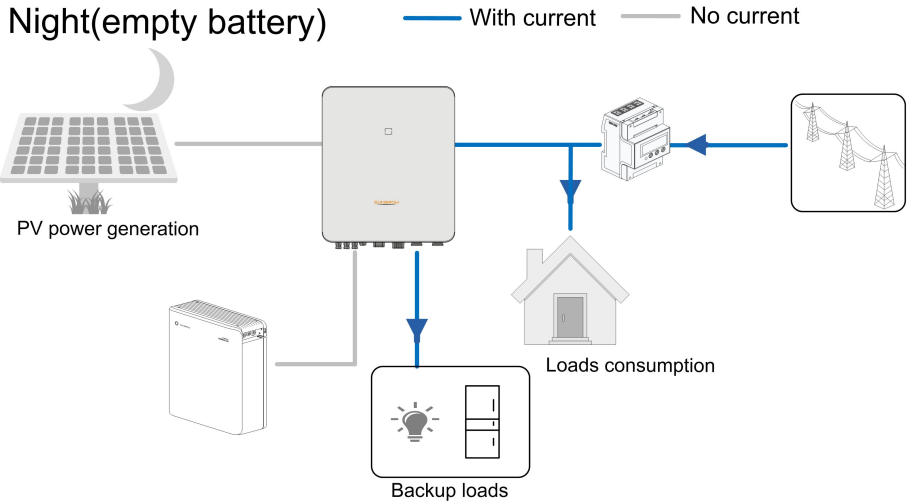
**Energy Management during Night**

During night, with energy available, the battery will discharge to supply power for loads. Alternatively, the grid will supply power for the loads in case the discharge power of the battery is insufficient.



During night, when the battery is empty, it will enter into standby mode. In this case, the grid will supply all power for loads.





### 2.3 Retrofitting the Existing PV System

The hybrid inverter is compatible with any three-phase PV grid-connected inverters. An existing PV system can be retrofitted to be a PV ESS with the addition of the hybrid inverter.

The power generation from the existing PV inverter will be firstly provided to the loads and then charge the battery. With the energy management function of the hybrid inverter, the self-consumption of the new system will be greatly improved.

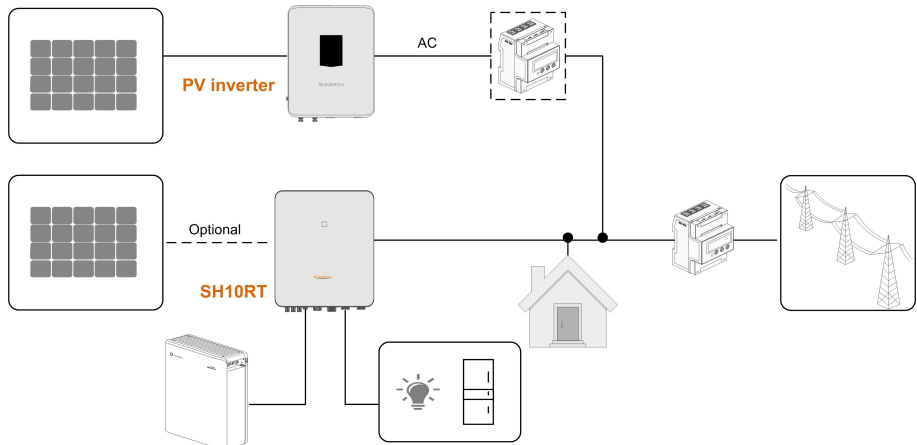


Figure 2-4 Retrofitting the Existing PV System

Note:

- 1 In zero-export scenario, the hybrid inverter can only ensure no power exported to grid itself but does not ensure zero export for the PV inverter. Please contact the PV inverter manufacturer for its zero-export solution.
- 2 PV modules for hybrid inverter are optional.

- 3 Monitoring function of the power generated by PV inverter will be available soon.

## 3 Function Description

### 3.1 Safety Function

#### 3.1.1 Protection

Several protective functions are integrated in the inverter, including short circuit protection, grounding insulation resistance surveillance, residual current protection, anti-islanding protection, DC overvoltage / over-current protection, etc.

#### 3.1.2 Earth Fault Alarm

The inverter has integrated a multiple-function dry-contact (DO relay), which can be used for the external alarm for earth fault. The external alarm needs to be powered by the grid.

The additional equipment required is a light indicator and/or a buzzer.

If an earth fault occurs:

- the DO dry-contact will switch on automatically to signal the earth fault alarm;
- the buzzer inside the inverter will also beep;
- the Ethernet communication port can be used for transmitting the alarm remotely.

### 3.2 Energy Conversion and Management

The inverter converts the DC power from the PV array or the battery to the AC power, in conformity with the grid requirements. It also transmits the DC power from the PV panel to the battery.

With the bidirectional converter integrated inside, the inverter can charge or discharge the battery.

Two string MPP trackers are used to maximize the power from PV strings with different orientations, tilts, or module structures.

#### 3.2.1 Power Derating

Power derating is a way to protect the inverter from overload or potential faults. In addition, the derating function can also be activated following the requirements of the utility grid. Situations requiring inverter power derating are:

- over-temperature (including ambient temperature and module temperature)
- high input voltage
- grid under-voltage
- grid over-frequency

- power factor (when values out of the rated values)
- high altitude

### 3.2.2 DRM ( “AU” / “NZ” )

The inverter provides a terminal block for connecting to a demand response enabling device (DRED). The DRED asserts demand response modes (DRMs). The inverter detects and initiates a response to all supported demand response commands within 2s. For the connections, see "6.11 DI/DRM Connection".

The following table lists the DRMs supported by the inverter.

**Table 3-1** Demand Response Modes (DRMs)

Mode	Explanation
DRM0	The inverter is in the state of “ Turn off ” .
DRM1	The import power from the grid is 0.
DRM2	The import power from the grid is no more than 50 % of the rated power.
DRM3	The import power from the grid is no more than 75 % of the rated power.
DRM4	The import power from the grid is 100 % of the rated power, but subject to the constraints from other active DRMs.
DRM5	The feed-in power to the grid is 0.
DRM6	The feed-in power to the grid is no more than 50 % of the rated power.
DRM7	The feed-in power to the grid is no more than 75 % of the rated power.
DRM8	The feed-in power to the grid is 100 % of the rated power, but subject to the constraints from other active DRMs.

The DRED may assert more than one DRM at a time. The following shows the priority order in response to multiple DRMs.

Multiple Modes	Priority Order
DRM1…DRM4	DRM1 > DRM2 > DRM3 > DRM4
DRM5…DRM8	DRM5 > DRM6 > DRM7 > DRM8

### 3.2.3 Regular Operational Voltage Range

The inverters can operate within the allowable voltage range for at least the specified observation time. The setting of the conditions depends on whether the connection is due to a normal operational start-up or an automatic reconnection after tripping of the interface protection.

When the voltage level is out of the operational levels, the inverter will disconnect from the grid within the protection time. If a disturbance lasts less than the required protection time, the inverter can reconnect to the grid once the voltage level goes back to normal levels after the disturbance.

### 3.2.4 Regular Operational Frequency Range

The inverter can operate within its frequency range for at least the specified observation time. The setting of conditions depends on whether the connection is due to a normal operational start-up or an automatic reconnection after tripping of the interface protection.

When the frequency level is outside the operational levels, the inverter will disconnect from the grid. If a disturbance lasts less than the required protection time, the inverter can reconnect to the grid once the frequency level goes back to normal levels after the disturbance.

### 3.2.5 Reactive Power Regulation

The inverter is capable of operating in reactive power regulation modes for the purpose of providing support to the grid. The reactive power regulation mode can be set via the iSolarCloud App. For details, see "[8.4.3 Reactive Power Regulation Mode](#)".

### 3.2.6 Load Control

The inverter has an integrated multiple-function dry-contact (DO relay), which can be used for load control via a contactor. Refer to "[6.10 DO Connection](#)" for the cable connection.

User may set the control mode according to individual demand. Refer to "[8.9.9 Load Regulation](#)" for iSolarCloud App settings.

**Timing Mode:** Set the starting time and end time. The DO function will be enabled during the time interval.

**Switch Mode:** The DO function can be enabled or disabled.

**Intelligent Mode:** Set the starting time, end time, and the optimized power. During the interval, when the export power reaches to the optimized power, the DO function will be enabled.

## 3.3 Battery Management

Li-ion battery from LG and BYD are compatible with the PV ESS, further battery models will be made compatible in the future.

To maximize the battery life, the inverter will perform battery charge, discharge, and battery maintenance based on the battery status communicated by the BMS.

#### NOTICE

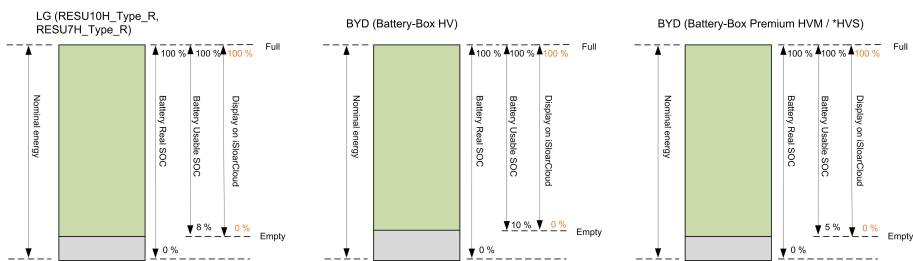
The recommended parameters listed in this section may be updated or revised due to product development. Please refer to the manual supplied by the battery manufacturer for the latest information.

### State Definition

In order to avoid overcharging or deep discharging of the battery, three battery statuses according to different voltage ranges has been defined, as shown in the following table.

**Table 3-2** Battery Status Definition

Type	Port Voltage / SOC		
	Empty	Normal	Full
LG (RESU10H_Type_R, RESU7H_Type_R)	SOC < 8 %	8 %...100 % (by default)	SOC = 100 %
BYD (Battery-Box HV)	SOC < 10 %	10 %...100 % (by default)	SOC = 100 %
BYD (Battery-Box Premium HVM / HVS)	SOC < 5 %	5 %...100 % (by default)	SOC = 100 %



In the off-grid state, the LG battery can only supply power to loads of maximum 5KW. For the first operation of the inverter with LG battery, either PV or grid needs to power the inverter to activate the LG battery.

The SOC limits of Li-ion batteries can be modified via the iSolarCloud App by qualified personnel.

### 3.3.1 Charge Management

#### Backup Charge Management

The emergency charge management function is to protect the battery from the damage caused by long time excessive discharge. The inverter cannot respond to discharge command during emergency charge. The following tables describe the emergency charge conditions for different types of batteries.

**Table 3-3** Backup Charge Management for Li-ion Battery

Status	Conditions
Trigger	Either of the following conditions is met:
	<ul style="list-style-type: none"> <li>• <math>SOC \leq (\text{Min. SOC}) - 3\%</math> (valid only when the Min. SOC is <math>\geq 3\%</math>).</li> <li>• A battery under-voltage warning is triggered.</li> <li>• An emergency charge command is reported to the inverter.</li> </ul>
	All the following conditions are met:
Finish	<ul style="list-style-type: none"> <li>• <math>SOC \geq (\text{Min. SOC}) - 1\%</math> (valid only when the Min. SOC is <math>\geq 3\%</math>).</li> <li>• The battery under-voltage warning is cleared.</li> <li>• The emergency charge command reported to the inverter is cleared.</li> </ul>

**Table 3-4** Default SOC Conditions for Li-ion Battery Backup Charge

Type	Trigger SOC	Finishing SOC
LG	$SOC \leq 5\%$	$SOC \geq 7\%$
BYD (Battery-Box HV)	$SOC \leq 7\%$	$SOC \geq 9\%$
BYD (Battery-Box Premium HVM / HVS)	$SOC \leq 2\%$	$SOC \geq 4\%$

### Normal Charge Management

When the battery voltage is within the normal range, the inverter can charge the battery if the PV power is higher than the load power and can ensure that the battery is never over-charged.

The maximum allowable charge current is limited to the smaller value among the following:

- the maximum charge current of the inverter (30A);
- the maximum / recommended charge current from the battery manufacturer.

For this reason, the battery charge power may not reach the nominal power.



- If the PV voltage is higher than the upper limit value of MPP voltage (1000 V), the battery cannot charge.
- The hybrid inverter will start to charge the battery when the export power value exceeds a pre-defined threshold value of 70 W.

### 3.3.2 Discharge Management

Discharge management can effectively protect the battery from deep discharging.

The maximum allowable discharge current is limited to the smaller value among the following:

- the maximum discharge current of the inverter (30A);
- the maximum / recommended discharge current from the battery manufacturer.

For this reason, the battery discharge power may not reach the nominal power.



- If the PV voltage is higher than the upper limit value of MPP voltage 1000 V, the battery cannot discharge.
- The hybrid system will start to discharge the battery when the import power value exceeds a threshold value of 70 W.

### 3.4 Communication and Configuration

The inverter provides various ports for device and system monitoring, including RS485, Ethernet, WLAN, and CAN; various parameters can be configured for optimal operation. All the inverter information is accessible through the iSolarCloud App.



## 4 Unpacking and Storage

### 4.1 Unpacking and Inspection

The inverter is thoroughly tested and strictly inspected before delivery. Damage may still occur during shipping. For this reason, please conduct a thorough inspection after receiving the device.

- Check the packing case for any visible damage.
- Check the scope of delivery for completeness according to the packing list.
- Check the inner contents for damage after unpacking.

Contact SUNGROW or the supplier in case of any damage or incompleteness.

Do not dispose of the original packing case. It is recommended to store the inverter in it.

### 4.2 Identifying the Inverter

The nameplate can be found on both the inverter and the packing case. It provides information on model of inverter, important specifications, marks of certification institutions, and serial numbers which are available and identified by SUNGROW. Take SH10RT as an example.

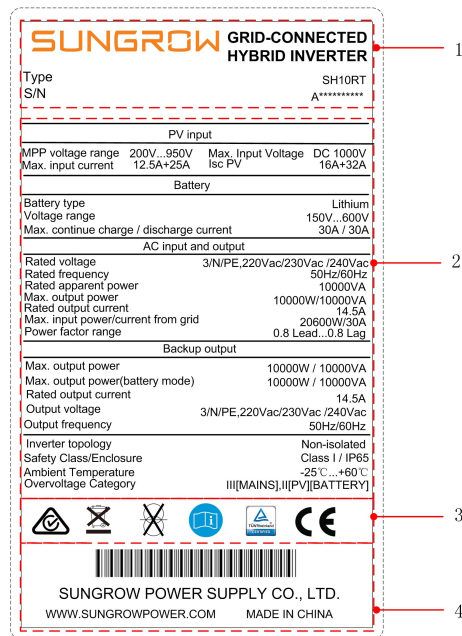




Figure 4-1 Nameplate of Inverters

\* The image shown here is for reference only. The actual product received may differ.

Item	Description
1	SUNGROW logo and product model
2	Technical data of inverter
3	Instructions and marks of conformity
4	Company name, website and country of manufacture

Table 4-1 Description of Icons on the Nameplate

Icon	Description
	RCM mark of conformity
	Do not dispose of the inverter together with household waste
	The inverter does not have a transformer
	Refer to the corresponding instructions

Icon	Description
	TÜV mark of conformity
	CE mark of conformity

### 4.3 Scope of Delivery

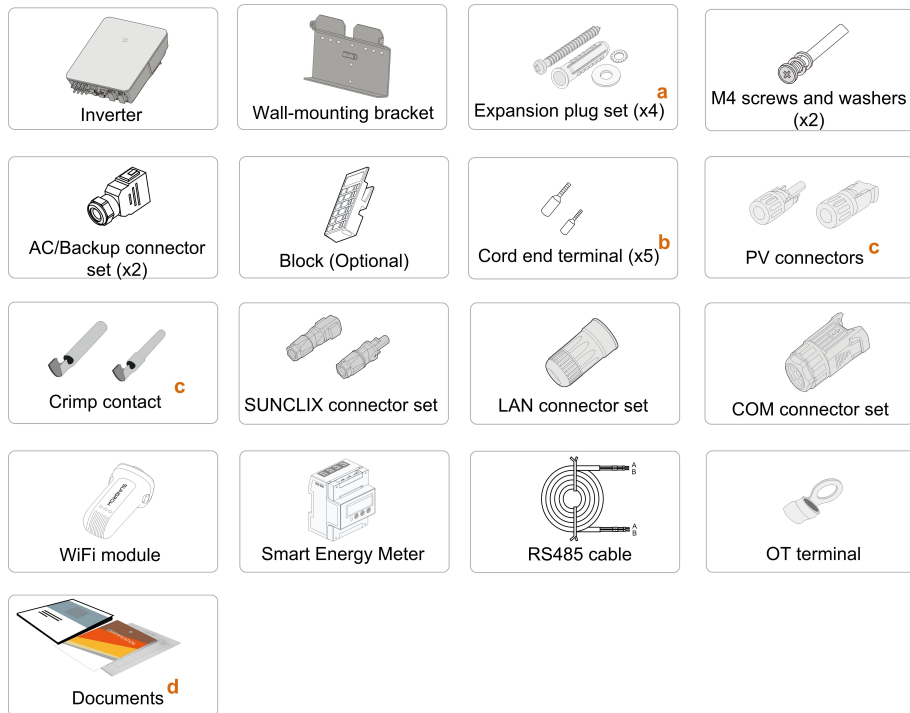


Figure 4-2 Scope of delivery

- Each set includes a self-tapping screw and an expansion tube.
- There are cord end terminals of two specifications (5 for each specification) used to connect AC cables. Select appropriate terminals according to the cable cross-section area.
- Two or three pairs, depending on inverter model.
- The documents include a Quick Installation Guide for the inverter, a packaging list, warning labels, quality certificates and product test reports.

### 4.4 Inverter Storage

Proper storage is required if the inverter is not installed immediately.

- Store the inverter in the original packing case with the desiccant inside.

- The storage temperature must be always between  $-30^{\circ}\text{C}$  and  $+70^{\circ}\text{C}$ , and the storage relative humidity must be always between 0 and 95 %, non-condensing.
- In case of stacking storage, the number of stacking layers should never exceed the limit marked on the outer side of the packing case.
- The packing should be upright.
- If the inverter has been stored more than half a year, the qualified personnel should thoroughly check and test it before installation.

# 5 Mechanical Mounting

## 5.1 Safety during Mounting

### DANGER

Make sure there is no electrical connection before installation.  
In order to avoid electric shock or other injury, make sure that holes will not be drilled over any electricity or plumbing installations.

### CAUTION

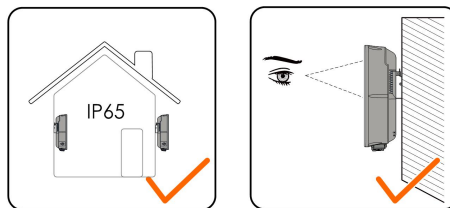
Risk of injury due to improper handling

- Always follow the instructions when moving and positioning the inverter.
- Improper operation may cause injuries or serious wounds. In the case of poor ventilation, the system performance may compromise.
- Keep the heat sinks uncovered to ensure heat dissipation performance.

## 5.2 Location Requirements

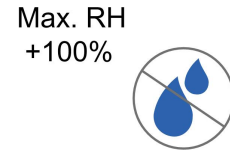
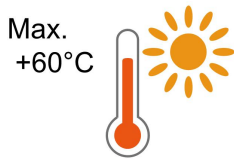
Select an optimal mounting location for safe operation, long service life and expected performance.

- The inverter with IP 65 can be installed both indoors and outdoors.
- Install the inverter in a place convenient for electrical connection, operation, and maintenance.



### 5.2.1 Installation Environment Requirements

- The installation environment must be free of inflammable or explosive materials
- The location should be not accessible to children
- The ambient temperature and relative humidity must meet the following requirements



- Avoid direct exposure to sun, rain and snow
- The inverter should be well ventilated. Ensure air circulation
- Never install the inverter in living areas. The inverter will generate noise during operation, affecting daily life

### 5.2.2 Carrier Requirements

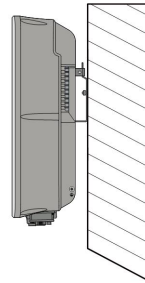
The installation carrier should meet the following requirements:



Made of non-flammable materials

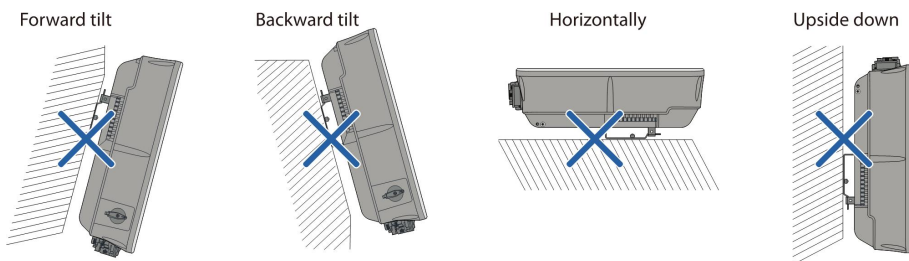


Max. load bearing capacity  $\geq 4$  times the inverter weight



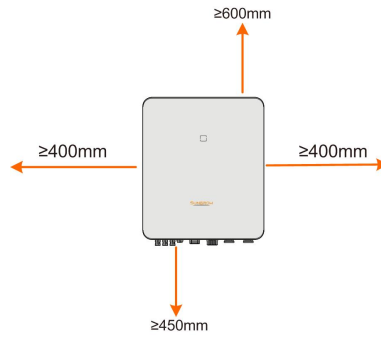
### 5.2.3 Installation Angle Requirements

Never install the inverter horizontally, or with a forward tilt/backward tilt, or even upside down.

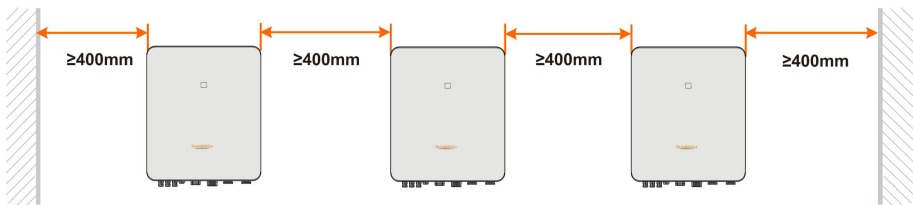


### 5.2.4 Installation Clearance Requirements

- Reserve enough clearance around the inverter to ensure sufficient space for heat dissipation.



- In case of multiple inverters, reserve specific clearance between the inverters.



- Install the inverter at an appropriate height for ease of viewing LED indicators and operating switches.

### 5.3 Installation Tools

Installation tools include but are not limited to the following recommended ones. If necessary, use other auxiliary tools on site.

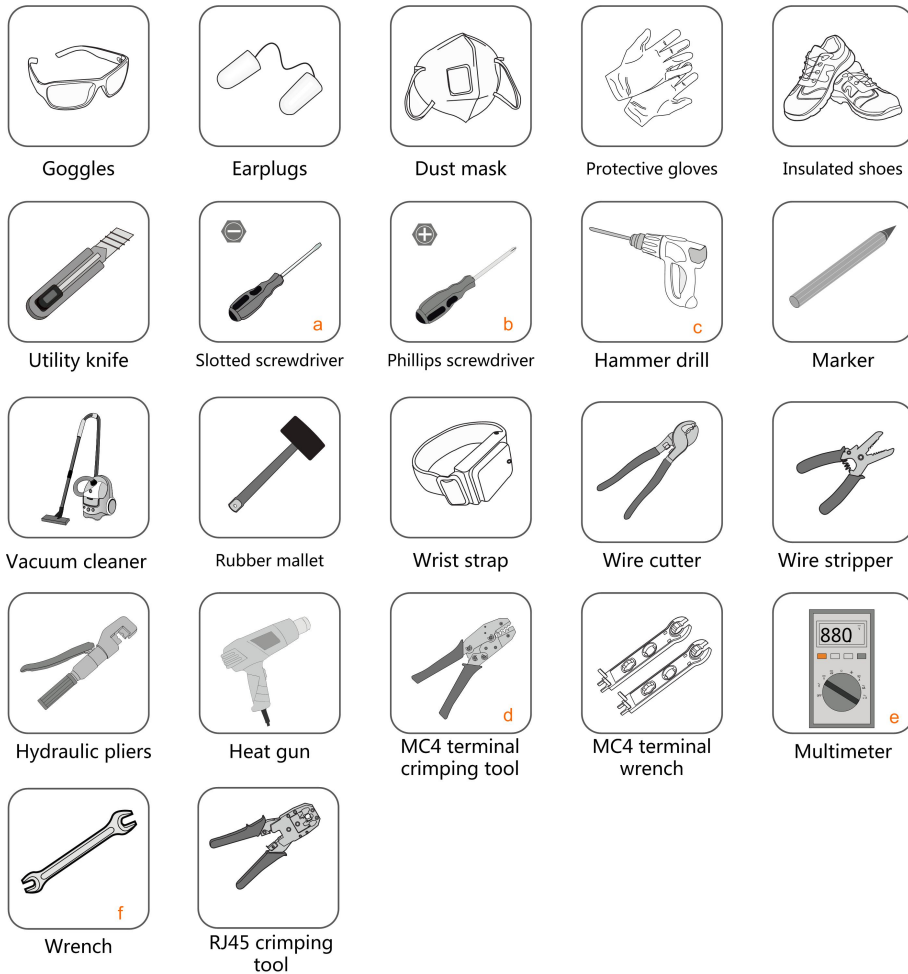


Table 5-1 Tool specification

No.	Specification
a	M4
b	M4
c	Drill bit: D10
d	Crimp range: 4~6mm <sup>2</sup>
e	Range $\geq$ 1000Vdc
f	Opening: 16mm, 46mm

## 5.4 Moving the Inverter

Before installation, remove the inverter from the packing case and move it to the installation site. Follow the instructions below as you move the inverter:

- Always be aware of the weight of the inverter.

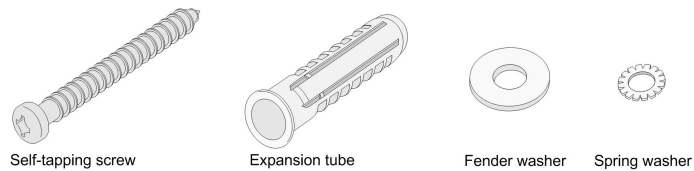


- Lift the inverter using the handles positioned on both sides of the inverter.
- Move the inverter by at least two people or by using a proper transport tool.
- Do not release the equipment unless it has been firmly secured.

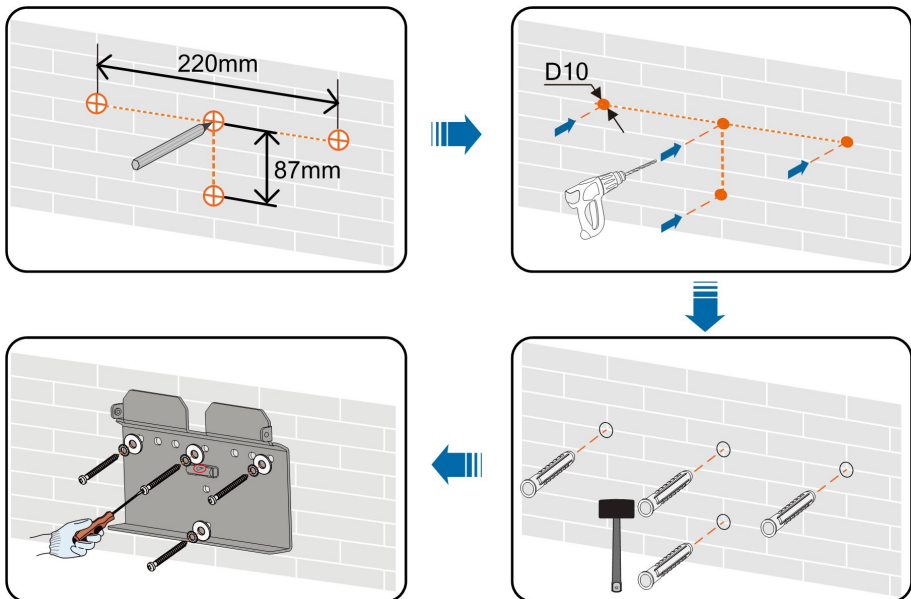
## 5.5 Installing the Inverter

Install the inverter on the wall using the provided wall-mounting bracket and expansion plug sets.

The expansion plug set shown below is recommended for the installation.



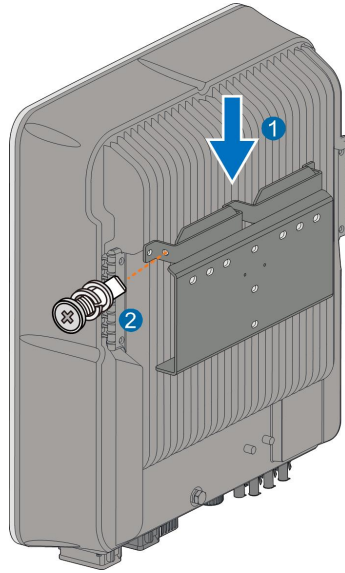
**Step 1** Install the wall-mounting bracket.



Note:

- 1 The depth of the holes should be about 70 mm.
- 2 The air bubble in the bracket must be between the two lines in the red circles to ensure the horizontal level.

**Step 2** Mount the inverter to the bracket. Secure the inverter with two M4 screws and washers. (1.5 N•m)



-- End

## 6 Electrical Connection

### 6.1 Safety Instructions

Prior to any electrical connections, keep in mind that the inverter has dual power supplies. It is mandatory for the qualified personnel to wear personal protective equipment (PPE) during the electrical work.

#### DANGER

Danger to life due to a high voltage inside the inverter!

- The PV string will generate lethal high voltage when exposed to sunlight.
- Before starting electrical connections, disconnect the DC and AC circuit breakers and prevent them from inadvertent reconnection.
- Ensure that all cables are voltage free before performing cable connection.

#### WARNING

- Any improper operations during cable connection can cause device damage or personal injury.
- Only qualified personnel can perform cable connection.
- All cables must be undamaged, firmly attached, properly insulated and adequately dimensioned.

#### NOTICE

Comply with the safety instructions related to the PV strings and the regulations related to the utility grid.

- All electrical connections must be in accordance with local and national standards.
- Only with the permission of the local utility grid company, the inverter can be connected to the utility grid.

### 6.2 Terminal Description

All electrical terminals are located at the bottom of the inverter.

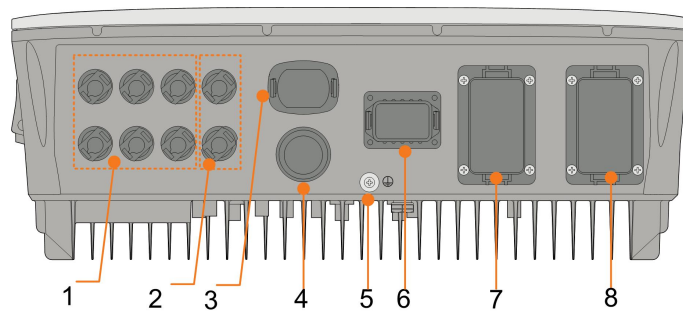


Figure 6-1 Terminals at the Bottom of the Inverter

\* The image shown here is for reference only. The actual product received may differ.

No.	Name	Description
1	PV terminals	Positive and negative DC input connectors Two or three pairs, depending on the inverter model
2	Battery connection	Connectors for the battery power cables
3	WLAN terminal	Connector for the WiFi module
4	LAN terminal	Connector for the EMS, router, and data logger
5	Additional grounding terminal	For reliable grounding
6	COM terminal	Connector for Smart Energy Meter, RS485, BMS/CAN, DRM/DI and DO
7	BACK-UP terminal	AC terminal reserved for Backup loads
8	GRID terminal	AC terminal for connection to the utility grid

Table 6-1 The label of COM terminal

Meter		BMS/CAN		DI/DRM			DO
A2	B2	H	L	D1/5	D3/7	R	NO
A1	B1	EN_H	EN_G	D2/6	D4/8	C	COM
RS485		Enable					

Table 6-2 The label description of COM terminal

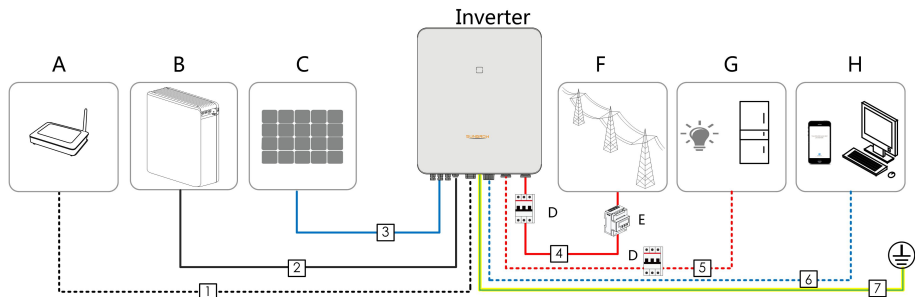
No.	Label	Description
1	Meter (A2, B2)	Connect to the Smart Energy Meter.
2	RS485 (A1, B1)	<ul style="list-style-type: none"> <li>Connect to the LG Li-ion battery , use with Enable terminal</li> <li>Connect to an external device to receive the command to shut down the inverter remotely (Italy only)</li> </ul>

No.	Label	Description
3	BMS/CAN	To enable the communication between the inverter and the Li-ion battery
4	Enable	Connect to the LG Li-ion battery , use with RS485 terminal
5	DI/DRM	<ul style="list-style-type: none"> <li>"AU"/"NZ": Demand response enabling device (DRED)</li> <li>"IT": interface protection system (SPI)</li> <li>"DE": Ripple Control Receiver (RCR), NS Protection</li> </ul>
6	DO	<ul style="list-style-type: none"> <li>Connect to an external light indicator and/or buzzer to signal an alarm.</li> <li>Connect to home load (such as SG Ready Heat Pump) for power management.</li> </ul>

## 6.3 Electrical Connection Overview

### System Wiring Diagram

The electrical connection should be realized as follows:



Item	Designation
A	Router
B	Battery
C	PV string
D	AC circuit breaker
E	Smart Energy Meter
F	Grid
G	Backup loads
H	Monitoring device

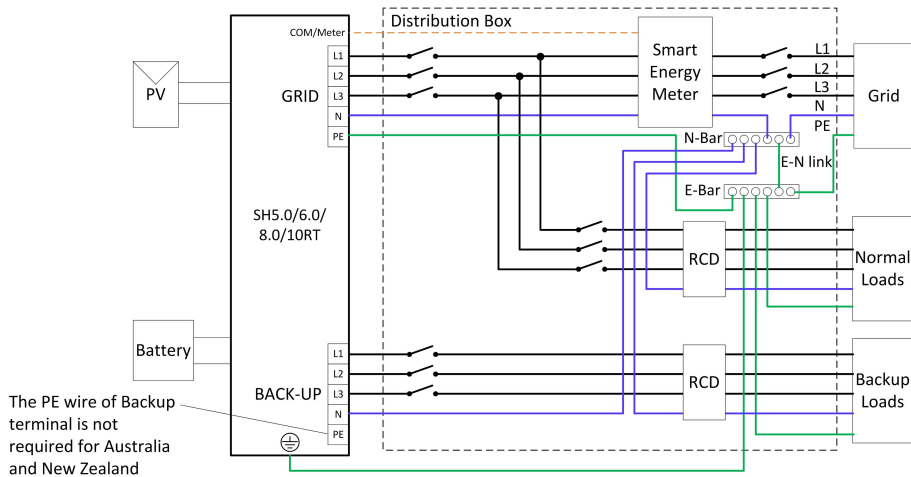
Table 6-3 Cable requirements

No.	Cable	Type	Specification	
			Outer diameter (mm)	Cross section (mm <sup>2</sup> )
1	Ethernet cable	CAT 5E outdoor shielded network cable	5.3 ~ 7 mm	8 * 0.2 mm <sup>2</sup>
2	Power Cable	Complying with 1,000V and 35A standard	5.5 ~ 8 mm	4 mm <sup>2</sup>
		Complying with 1,000V and 40A standard		6 mm <sup>2</sup>
3	DC cable	Outdoor multi-core copper wire cable Complying with 1,000V and 30A standard	6 ~ 9 mm	4 ~ 6 mm <sup>2</sup>
4	AC cable *	Outdoor multi-core	14 ~ 25 mm	6 ~ 10 mm <sup>2</sup>
5		copper wire cable	12 ~ 14mm	4 ~ 6 mm <sup>2</sup>
6	Communication cable	Shielded twisted pair	5.3 ~ 7 mm	2 * (0.5 ~ 1.0) mm <sup>2</sup>
		CAT 5E outdoor shielded network cable		8 * 0.2 mm <sup>2</sup>
7	Additional Grounding cable *	Outdoor single-core copper wire cable	The same as that of the PE wire in the AC cable	

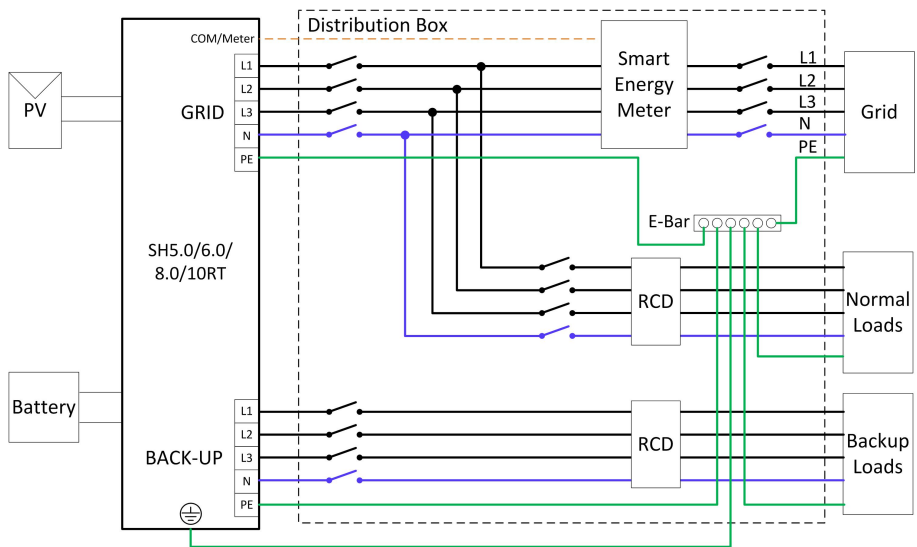
\* If local regulations have other requirements for cables, set the cable specification according to the local regulations.

### Backup Wiring Diagram

Neutral line of alternative supply must not be isolated or switched. (applies to wiring rules AS/NZS\_3000:2012 for Australia and New Zealand)



Neutral line of alternative supply must be disconnected after the grid is off. (applies to other countries)



## 6.4 Additional Grounding Connection

### ⚠ WARNING

- Since the inverter is transformerless, neither the negative pole nor the positive pole of the PV string must be grounded. Otherwise, the inverter will not operate normally.
- Connect the additional grounding terminal to the protective grounding point before AC cable connection, PV cable connection, and communication cable connection.
- The ground connection of this additional grounding terminal cannot replace the connection of the PE terminal of the AC cable. Make sure the two terminals are both grounded reliably.

### 6.4.1 Additional Grounding Requirements

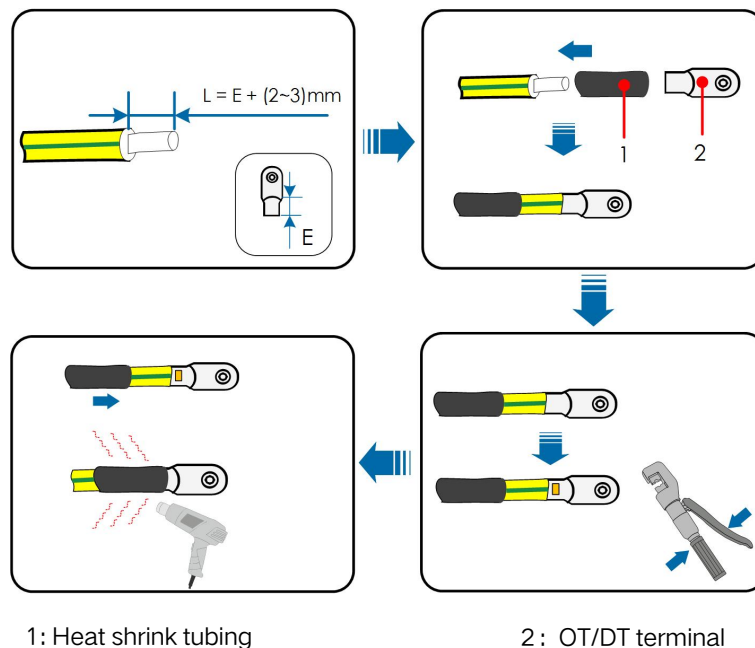
All non-current carrying metal parts and device enclosures in the PV power system should be grounded, for example, brackets of PV modules and inverter enclosure. When there is only one inverter in the system, connect the additional grounding cable to a nearby grounding point.

### 6.4.2 Connection Procedure

There are two additional grounding terminals located at the bottom and right side of the inverter. Connect either one.

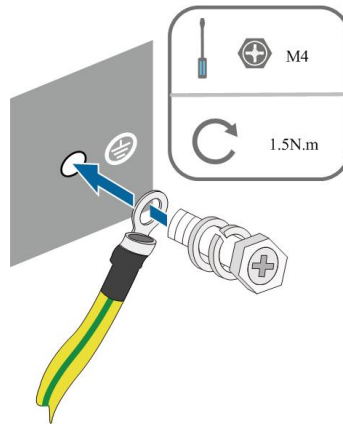
Additional grounding cable is prepared by customers.

**Step 1** Prepare the cable and OT/DT terminal.





**Step 2** Remove the screw on the grounding terminal and fasten the cable with a screwdriver.



**Step 3** Apply paint to the grounding terminal to ensure corrosion resistance.

-- End

## 6.5 AC Cable Connection

### 6.5.1 AC Side Requirements

#### AC Circuit Breaker

An independent three or four-pole circuit breaker must be installed on the output side of the inverter to ensure safe disconnection from the grid.

Inverter Model	Recommended AC circuit breaker current
SH5.0RT	20 A
SH6.0RT	32 A
SH8.0RT	63 A
SH10RT	63 A

#### NOTICE

- Multiple inverters cannot share one circuit breaker.
- Never connect a load between the inverter and the circuit breaker.

#### Residual Current Monitoring Device

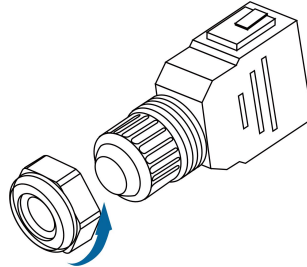
With an integrated universal current-sensitive residual current monitoring unit included, the inverter will disconnect immediately from the mains power once a fault current with a value exceeding the limit is detected.

However, if an external residual current device (RCD) is mandatory, the switch must be triggered at a residual current of 300 mA (recommended), or it can be set to other values according to local regulations. For example in Australia, the inverter can use an additional 30mA ( Type A ) RCD in installations.

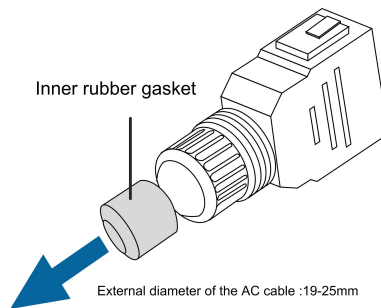
## 6.5.2 Assembling the AC Connector

The AC terminal block is on the bottom of the inverter. AC connection is the three-phase-four-wire grid +PE connection (L1, L2, L3, N, and PE).

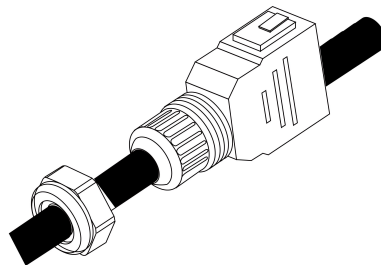
**Step 1** Unscrew the waterproof terminal of the AC connector counter clockwise.



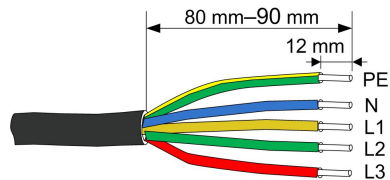
**Step 2 (Optional)** Remove the inner rubber gasket if the external diameter of the to-be-used AC cable ranges from 19~25mm.



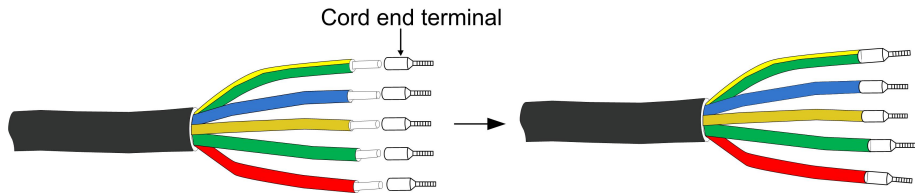
**Step 3** Thread the AC cable of appropriate length through the waterproof terminal.



**Step 4** Remove the cable jacket by 80~90 mm, and strip the wire insulation by 12 mm.

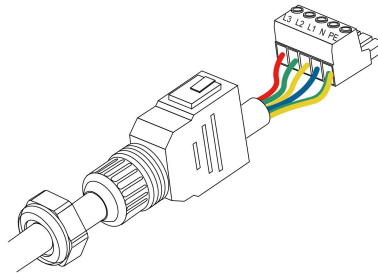


**Step 5** When using a multi-core multi-strand copper wire cable, connect the AC cable head to the cord end terminal by appropriate torque.



- Select appropriate cord end terminal according to the cable cross-section area.
- In case of single-strand copper wire, skip installing any cord end terminal.

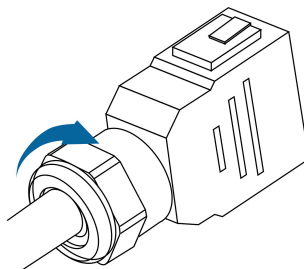
**Step 6** Fix all cables to the corresponding terminals with torque of 1.2-1.5 N•m, according to markings on the connector with a screwdriver, especially the “PE” cable. Avoid connecting the phase line to the terminal of "PE" or "N" cable, and otherwise, the inverter will be damaged.



**Step 7** Pull cables outward to check whether they are firmly installed.

**Step 8** Connect the front and the back parts until there is an audible click.

**Step 9** Tighten the waterproof terminal clockwise.



-- End

### 6.5.3 Installing the AC Connector

#### **⚠ DANGER**

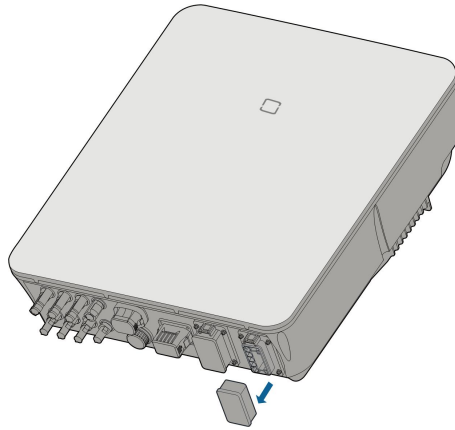
High voltage may be present in inverter!

Ensure all cables are voltage-free before electrical connection.

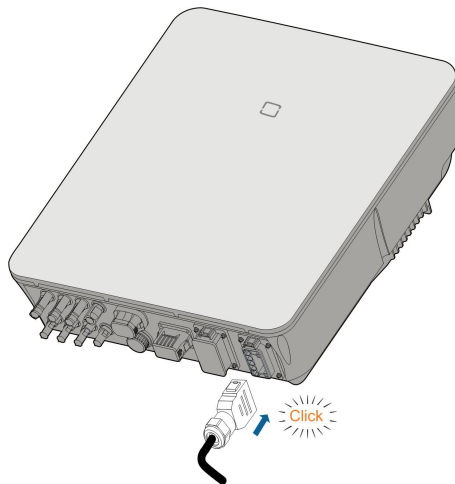
Do not connect the AC circuit breaker until all inverter electrical connections are completed.

**Step 1** Disconnect the AC circuit breaker and secure it against reconnection.

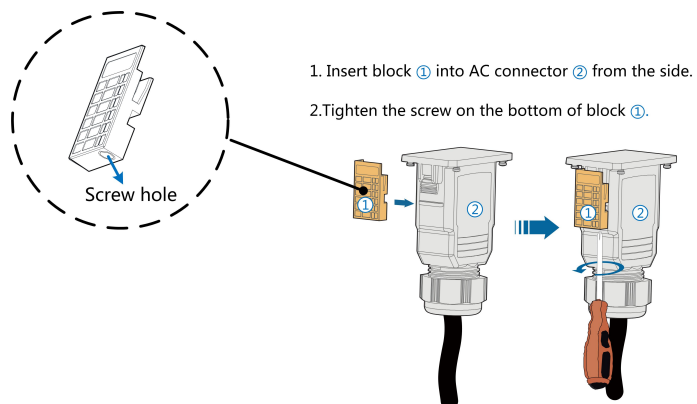
**Step 2** Remove the waterproof lid from the **GRID** terminal.



**Step 3** Insert the AC connector into the **GRID** terminal on the bottom of the inverter until there is an audible sound.



**Step 4 (Optional)** Insert the block into AC connector, as shown in the figure below.



**Step 5** Connect PE cable to ground.

**Step 6** Connect phase cable and “ N ” cable to AC circuit breaker.

#### NOTICE

Observe the terminal layout on the block. Do not connect the phase wires to "PE" terminal or PE wire to "N" terminal. Otherwise, unrecoverable damage to the inverter may follow.

**Step 7** Connect AC circuit breaker to utility grid.

**Step 8** Make sure all AC cables are firmly installed via the right torque tool or dragging the cables slightly.

-- End

## 6.6 DC Cable Connection

#### DANGER

Danger of electric shock!  
The PV array will generate lethal high voltage once exposed to sunlight.

#### WARNING

Make sure the PV array is well insulated to ground before connecting it to the inverter.

#### WARNING

Before connecting the PV array to the inverter, ensure that the impedances between the positive terminals of the PV string and earth, and between the negative terminals of the PV string and earth are larger than 1 M Ohm.

#### NOTICE

Risk of inverter damage! Observe the following requirements. Failure to do so will void guarantee and warranty claims.

- Make sure the maximum voltage of each string is always less than 1,000 V.
- Make sure the maximum short circuit current on the DC side is within the permissible range.

**NOTICE**

Each pair of PV terminals is corresponding to an independent PV string. If two PV strings are paralleled externally, the paralleled strings can be connected to PV2 or PV3 only, and the other one cannot be used to connect other PV strings. (only applicable to SH10RT)

**6.6.1 PV Input Configuration**

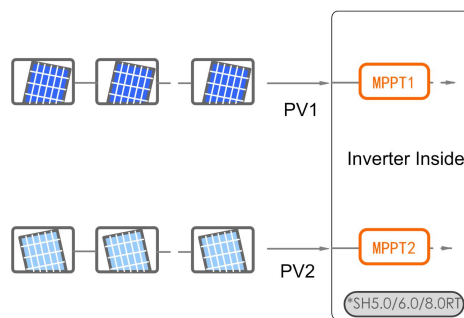
In Australia and New Zealand, ensure the DC power for any PV string never exceeds a certain level with regards to the string voltage to avoid derating:

≤ 12.5 kW if string voltage is lower than 500 V

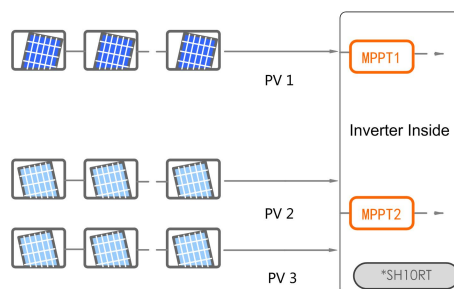
≤ 10 kW if string voltage is between 500 V and 800 V

≤ 8 kW if string voltage is between 800 V and 1000 V

For SH5.0/6.0/8.0RT, each PV input operates independently and has its own MPPT. In this way, string structures of each PV input may differ from each other, including PV module type, number of PV modules in each string, angle of tilt, and installation orientation.



For SH10RT, each PV input area includes two PV inputs PV2 and PV3. For the best use of PV power, PV2 and PV3 should be the same in PV string structure, including the type, number, tilt, and orientation of the PV modules.



Prior to connecting the inverter to PV inputs, the following electrical specifications must be met simultaneously:

Model	Open-circuit Voltage Limit	Max. current for Input Connector
SH5.0RT	1000 V	30 A

Model	Open-circuit Voltage Limit	Max. current for Input Connector
SH6.0RT		
SH8.0RT		
SH10RT		

### 6.6.2 DC Side Requirements

SUNGROW provides corresponding plug connectors in the scope of delivery for quick connection of PV inputs. DC cables should be connected to the inverter via PV connectors which are included in the scope of delivery.



To ensure IP65 protection, use only the supplied connector or the connector with the same ingress of protection.

#### NOTICE

The input current of each input channel should be less than 30 A.

### 6.6.3 Assembling the PV Connector

#### **⚠ DANGER**

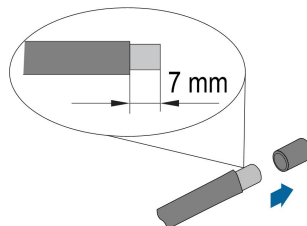
High voltage may be present in the inverter!

- Ensure all cables are voltage-free before performing electrical operations.
- Do not connect the AC circuit breaker before finishing electrical connection.

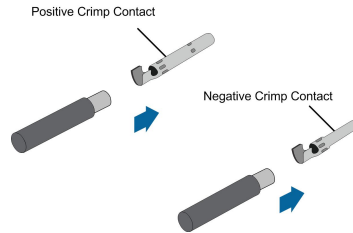
#### NOTICE

Use the MC4 DC terminal within the scope of delivery. Damage to the device due to the use of incompatible terminal shall not be covered by the warranty.

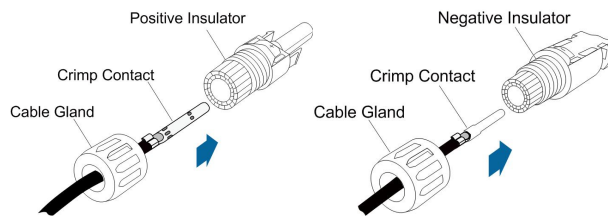
**Step 1** Strip the insulation from each DC cable by 7mm.



**Step 2** Assemble cable ends with crimp contacts by crimping pliers.



**Step 3** Lead the cable through cable gland. Insert the crimp contact into the insulator until it snaps into place. Gently pull the cable backward to ensure firm connection. Tighten the cable gland and the insulator (torque  $2.5 \text{ N} \cdot \text{m}$  to  $3 \text{ N} \cdot \text{m}$ ).



For further assembly and connection instruction, please visit the website of the device manufacturer.

**Step 4** Check for polarity correctness.

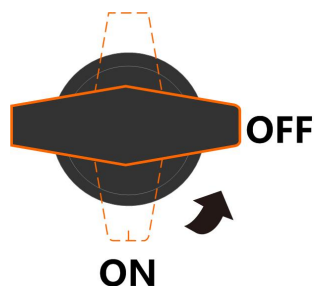
#### NOTICE

The inverter will not function properly if any PV polarity is reversed.

-- End

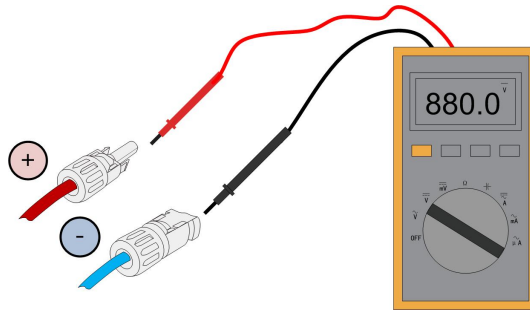
### 6.6.4 Installing the PV Connector

**Step 1** Rotate the DC switch to "OFF" position.



**Step 2** Check the cable connection of the PV string for polarity correctness and ensure that the open circuit voltage in any case does not exceed the inverter input limit of 1,000V.

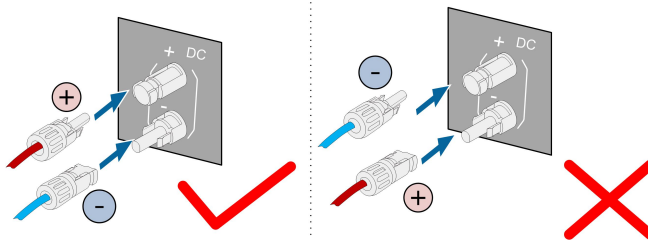




**Step 3** Connect the PV connectors to corresponding terminals until there is an audible click.

#### NOTICE

- Check the positive and negative polarity of the PV strings, and connect the PV connectors to corresponding terminals only after ensuring polarity correctness.



- Arc or contactor over-temperature may occur if the PV connectors are not firmly in place, and SUNGROW shall not be held liable for any damage caused due to this operation.

**Step 4** Follow the foregoing steps to connect PV connectors of other PV strings.

**Step 5** Seal any unused PV terminal with a terminal cap.

-- End

## 6.7 Communication Connection

#### LAN function:

- Through the Modbus TCP/IP protocol, the EMS or the Logger from the third party can fully control the on/off, derating, charging and discharging of the inverter.
- **(Optional)** The inverter operation information can be transferred to the iSolarCloud server via the router.

#### WLAN function:

With the WiFi module installed, view corresponding information through iSolarCloud App or iSolarCloud Web.

**RS485 function:**

The RS485 communication interfaces are used to establish communication connection with monitoring devices.

**6.7.1 Ethernet Connection**

The following figure shows how the Ethernet connection may work with a router.

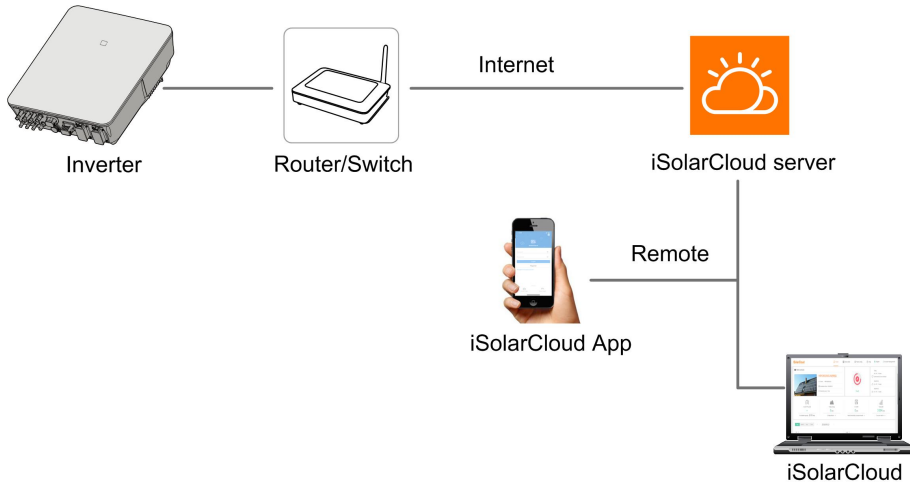
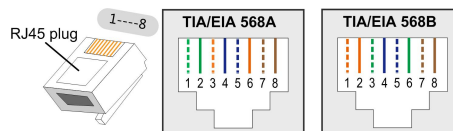


Figure 6-2 Ethernet Connection with a Router

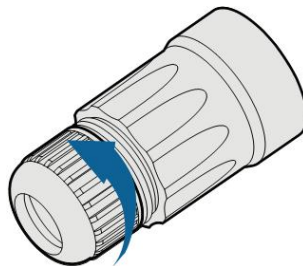
**6.7.1.1 Assembling the LAN Connector**

Skip step 1 if the standard network cable with RJ45 plug is prepared.

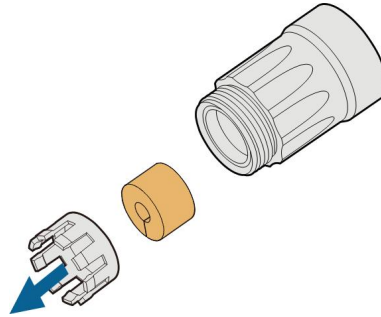
**Step 1 (Optional)** Strip the insulation layer of the communication cable with an Ethernet wire stripper, and lead the corresponding signal cables out. Insert the stripped communication cable into the RJ45 plug in the correct order, and crimp it with a crimper.



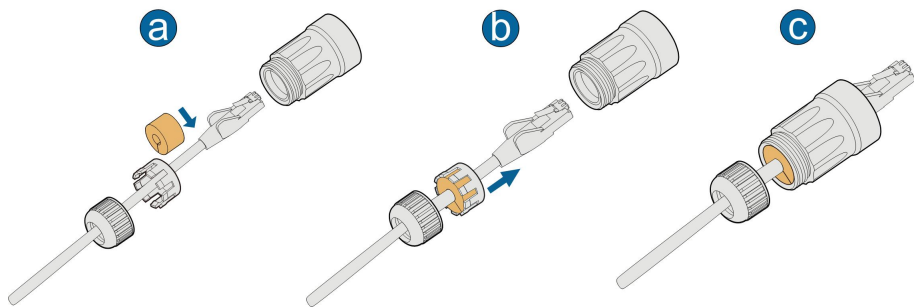
**Step 2** Unscrew the swivel nut from the LAN connector.



**Step 3** Remove the inner rubber gasket.



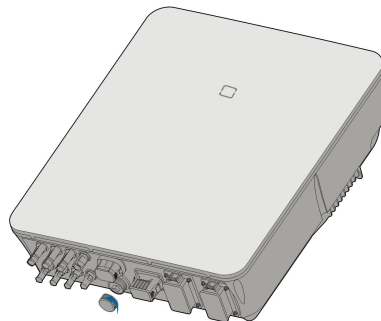
**Step 4** Insert the RJ45 plug into the front plug connector until there is an audible click, and install the rubber gasket.



-- End

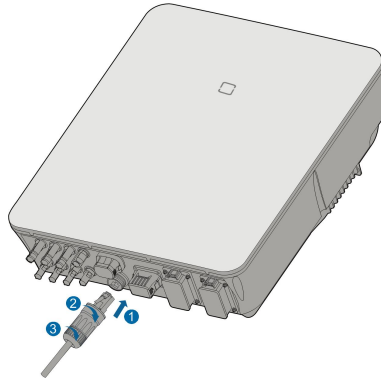
#### 6.7.1.2 Installing the LAN Connector

**Step 1** Unscrew the waterproof lid from the LAN terminal.



**Step 2** Insert the LAN connector into LAN terminal on the bottom of the inverter.

**Step 3** Pull cables outwards to confirm whether they are fastened firmly, then tighten the swivel nut with appropriate torque.



-- End

### 6.7.2 WLAN Connection

The following figure shows how the WLAN connection may work with the WiFi module.

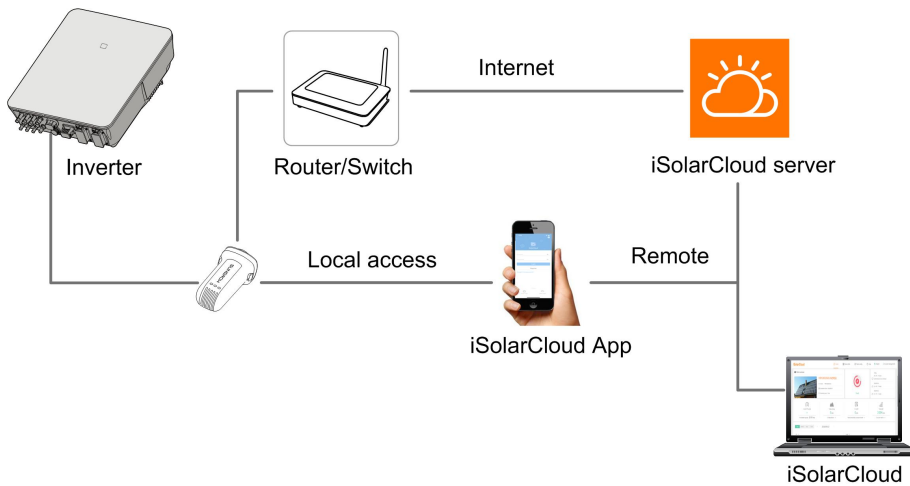
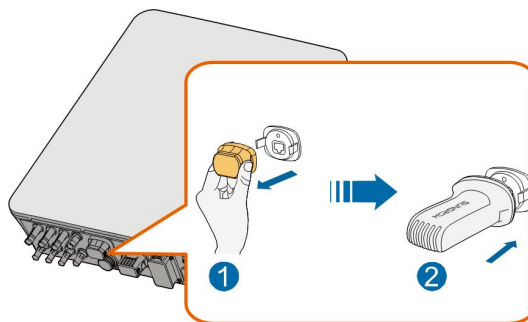


Figure 6-3 WLAN Connection with the WiFi module

**Step 1** Remove the waterproof lid from the **WLAN** terminal.

**Step 2** Install the WiFi module. Slightly shake it by hand to determine whether it is installed firmly, as shown below.



**Step 3** Refer to the quick guide for the WiFi module to configure the WLAN.

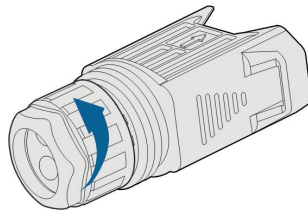
-- End

### 6.7.3 RS485 Connection

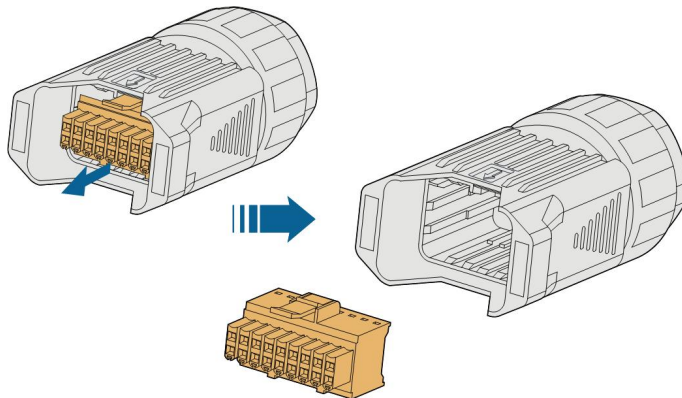
The RS485 connection can establish the communication between an external device. In Italy, the RS485 connection can be used to receive the command to shut down the inverter remotely.

#### 6.7.3.1 Assembling the COM Connector

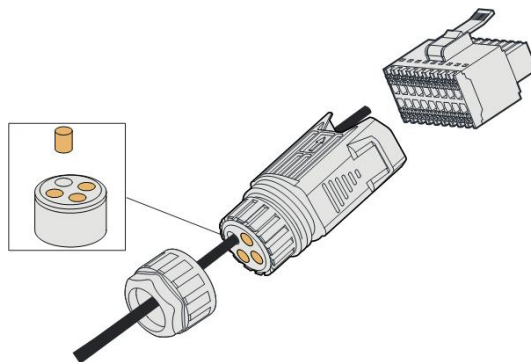
**Step 1** Unscrew the swivel nut from the **COM** connector.



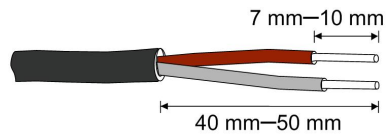
**Step 2** Take out the terminal block.



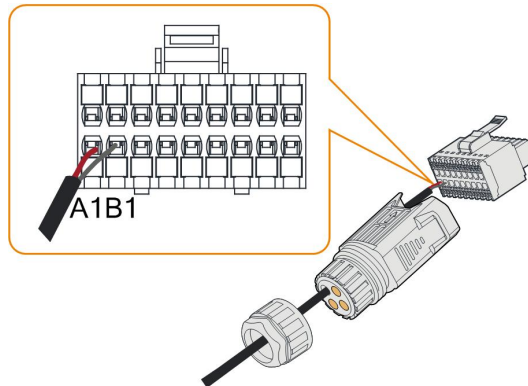
**Step 3** Remove the seal and lead the cable through the cable gland.



**Step 4** Remove the cable jacket and strip the wire insulation.

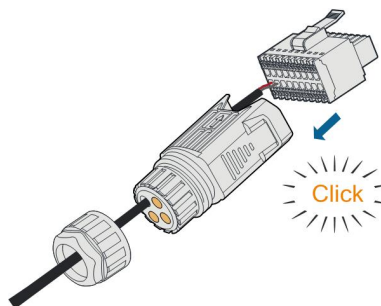


**Step 5** Plug the wires into the **RS485** terminal according to the labels on the bottom of the inverter.

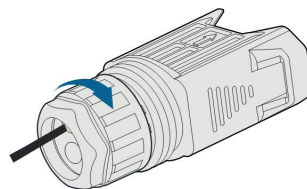


**Step 6** Pull the wires outward to check whether they are firmly installed.

**Step 7** Insert the terminal block into the connector until it snaps into place with an audible click.



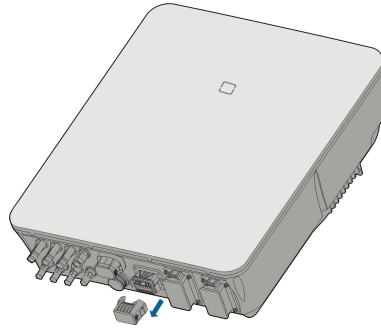
**Step 8** Fasten the swivel nut.



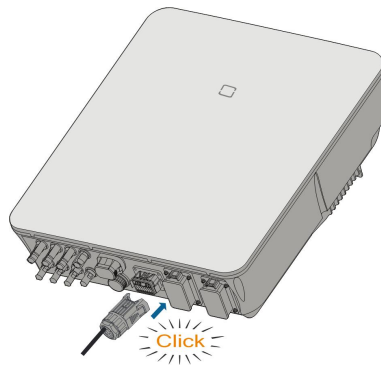
-- End

### 6.7.3.2 Installing the COM Connector

**Step 1** Remove the waterproof lid from the **COM** terminal.



**Step 2** Insert the COM connector into **COM** terminal on the bottom of the inverter until there is an audible click.



-- End

## 6.8 Smart Energy Meter Connection

The inverter is equipped with the feed-in power limit function, so as to meet the requirements of some national standards or grid standards for the output power at the grid connection point. For the setting of feed-in power limit, refer to the section "[8.4.1 Feed-in Limitation](#)".

Contact SUNGROW to ensure that the Smart Energy Meter model is available locally.



This section mainly describes the cable connections on the inverter side. Refer to the quick guide delivered with the Smart Energy Meter for the connections on the meter side.

### Procedure

For detailed connection description of the Smart Energy Meter cable, refer to the section "[6.7.3 RS485 Connection](#)". Plug the wires into the **Meter** terminal according to the labels on the bottom of the inverter.

## 6.9 Battery Connection

This section mainly describes the cable connections on the inverter side. Refer to the instructions supplied by the battery manufacturer for the connections on the battery side.

### WARNING

Only use properly insulated tools to prevent accidental electric shock or short circuits. If insulated tools are not available, use electrical tape to cover the entire exposed metal surfaces of the available tools except their tips.

### WARNING

The plug connector must be connected only by trained electricians.

### WARNING

Do not disconnect under load!  
Battery connectors must not be disconnected while under load. They can be placed in a no load state by shutting down the inverter completely.

### 6.9.1 Connecting the Power Cable

A fuse with the specification of 700 V / 50 A is integrated to the **BAT-** terminal.

#### NOTICE

A two-pole DC circuit breaker with over-current protection (voltage rating not less than 600 V and current rating not less than 40 A) should be installed between the inverter and the battery.

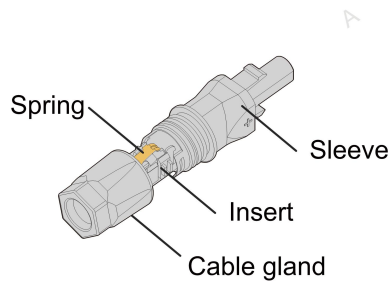
All power cables are equipped with water-proof direct plug-in connectors, which match the battery terminals at the bottom of the inverter.

#### 6.9.1.1 Assembling the SUNCLIX Connector

#### NOTICE

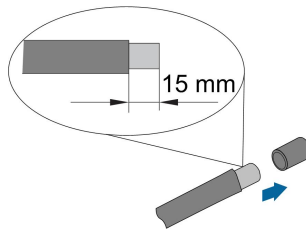
During assembly, be careful not to contaminate, pull out, or shift, the seal in the cable gland. A contaminated or shifted seal impairs strain relief and leak tightness.



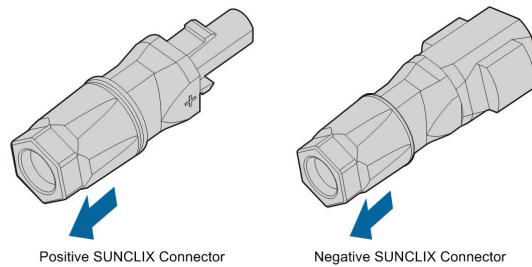


**Figure 6-4** SUNCLIX Connector Components

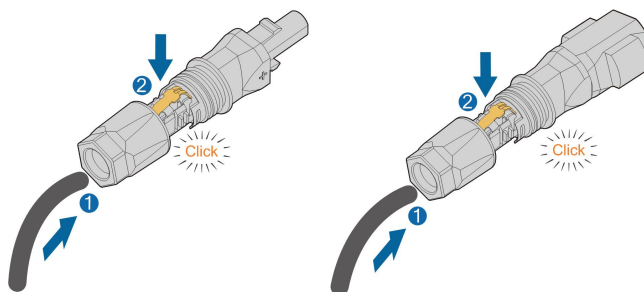
**Step 1** Strip the insulation from the cable by 15 mm.



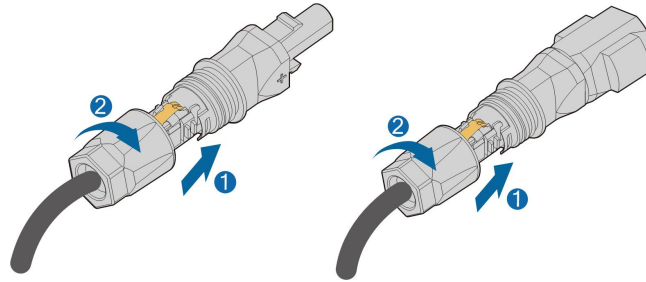
**Step 2** Pry the connection open and pull the sleeve and the insert apart.



**Step 3** Insert the stripped cable into the cable gland up to the stop. The stranded wire can be seen inside the spring. Press the spring down until it audibly snaps into place.



**Step 4** Push the insert into the sleeve and tighten the cable gland (torque 2 N · m).



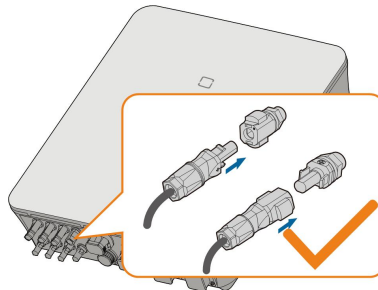
-- End

### 6.9.1.2 Installing the SUNCLIX Connector

#### NOTICE

Only connect these connectors with other SUNCLIX connectors. When making the connections, always observe the specifications regarding nominal voltage and nominal current. The smallest common value is permissible.

**Step 1** Plug the connectors into **BAT+** and **BAT-** terminals.



**Step 2** Ensure that the connectors are securely in place.

-- End

### 6.9.2 Connecting the CAN Cable

The CAN cable enables the communication between the inverter and the Li-ion battery from BYD.

#### Procedure

For detailed connection description of the CAN cable, refer to the section "[6.7.3 RS485 Connection](#)". Plug the wires into the **BMS/CAN** terminal according the labels on the bottom of the inverter.

### 6.9.3 Connecting the Enable Cable

The Enable cable along with the RS485 cable, are used for communication between the inverter and the Li-ion battery from LG.

### Procedure

For detailed connection description of the RS485 cable, refer to the section "[6.7.3 RS485 Connection](#)".

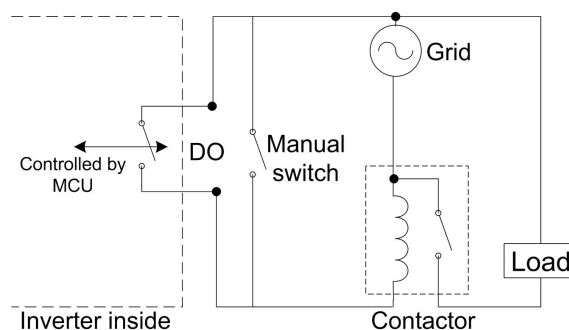
For detailed connection description of the Enable cable, refer to the section "[6.7.3 RS485 Connection](#)". Plug the wires into the **Enable** terminal according the labels on the bottom of the inverter.

## 6.10 DO Connection

The inverter has one DO relay with multiple functions as follows:

- Consumer load control. In this case the DO relay will control a contactor that will open or close in certain condition. Please choose the appropriate contactor according to the load power, e.g. the contactor types of the 3TF30 series from SIEMENS (3TF30 01- 0X).
- Earth fault alarm. In this case, the additional equipment required is a light indicator and/or a buzzer.

Relay	Trigger condition	Description
Consumer load control	The load control mode has been set via the iSolarCloud App.	The relay is activated once the conditions of the control mode are satisfied. See " <a href="#">8.9.9 Load Regulation</a> ".
Earth fault alarm	The earth fault occurs.	Once the inverter receives the earth fault signal, the relay closes the contact. The relay remains triggered until the fault is removed. See " <a href="#">8.9.12 Grounding Detection</a> ".



**NOTICE**

- An AC contactor must be installed between the inverter and appliances. It is forbidden to connect the load directly to the DO port.
- The current of the DO dry contact should not be larger than 3 A.
- The DO node is not controlled once the inverter is powered off. Connect the AC contactor by the manual switch, so as to control the loads.

**Procedure**

For detailed connection description of the DO cable, refer to the section "[6.7.3 RS485 Connection](#)". Plug the wires into the DO terminal according the labels on the bottom of the inverter.

## 6.11 DI/DRM Connection

**DRM**

The inverter supports the demand response modes as specified in the standard AS/NZS 4777. The inverter has integrated a terminal block for connecting to a DRED.

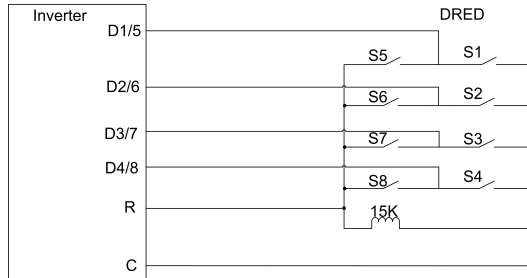
After the connection, the DRED assert DRMs by shorting together terminals as specified in "[Table 6-4 Method of Asserting DRMs](#)".

**Table 6-4** Method of Asserting DRMs

Mode	Asserted by Shorting Terminals
DRM0	R & C
DRM1	D1/5 & C
DRM2	D2/6 & C
DRM3	D3/7 & C
DRM4	D4/8 & C
DRM5	D1/5 & R
DRM6	D2/6 & R
DRM7	D3/7 & R
DRM8	D4/8 & R

The modes from DRM0 to DRM8 are supported by the inverter and the information is marked on the label located in the top of COM terminal.

Wiring between the inverter and the DRED is as follows.



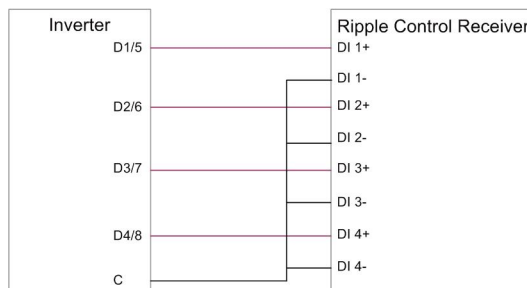
The switches that need to be closed in the state of DRM0 ~ DRM8 are shown in the table below.

Demand Response Mode	Operational Instruction	Switch state
DRM0	OI0	Close S1 and S5
DRM1	OI1	Close S1
DRM2	OI2	Close S2
DRM3	OI3	Close S3
DRM4	OI4	Close S4
DRM5	OI5	Close S5
DRM6	OI6	Close S6
DRM7	OI7	Close S7
DRM8	OI8	Close S8

### Ripple Control

In Germany, the grid company uses the Ripple Control Receiver to convert the grid dispatching signal and send it as a dry contact signal.

Wiring of the ripple control receiver dry contact catles is shown in the figure below:



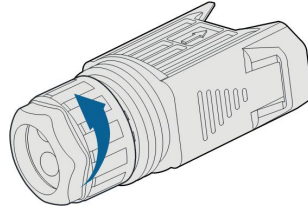
### NS Protection

Wiring of the NS Protection is shown in the figure below:

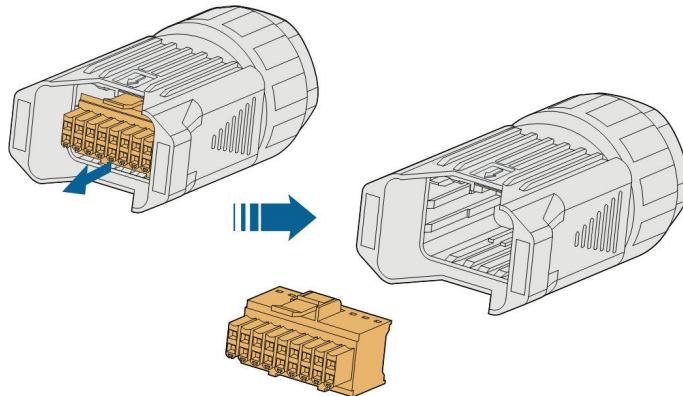


## 6.11.1 Assembling the COM Connector

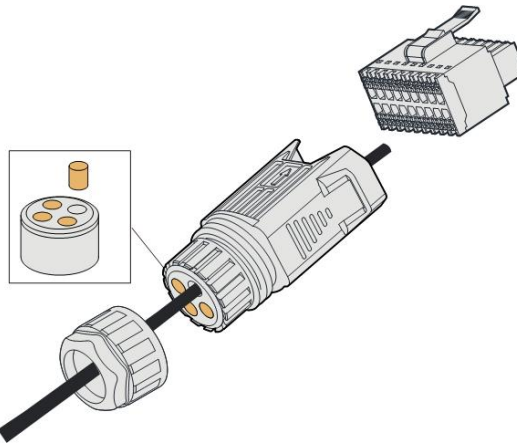
**Step 1** Unscrew the swivel nut from the **COM** connector.



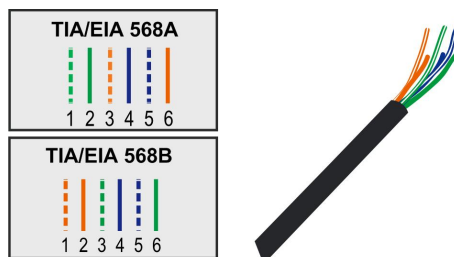
**Step 2** Take out the terminal block.



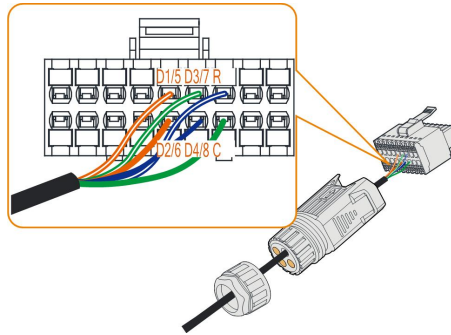
**Step 3** Remove the seal and lead the cable through the cable gland.



**Step 4** Remove the cable jacket by 7 mm – 10 mm.

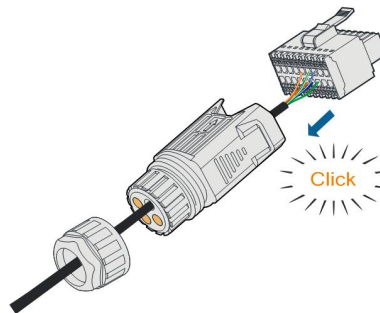


**Step 5** Plug the wires into the corresponding terminal according the labels on the bottom of the inverter.

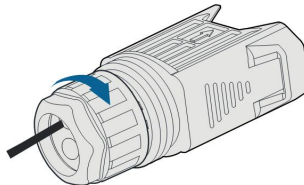


**Step 6** Pull the wires outward to check whether they are firmly installed.

**Step 7** Insert the terminal block into the connector until it snaps into place with an audible click.



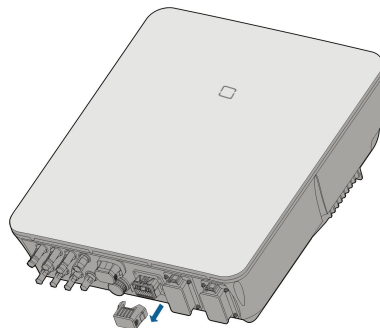
**Step 8** Fasten the swivel nut.



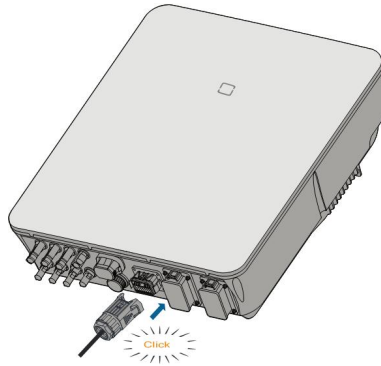
-- End

### 6.11.2 Installing the COM Connector

**Step 1** Remove the waterproof lid from the **COM** terminal.



**Step 2** Insert the COM connector into **COM** terminal on the bottom of the inverter until there is an audible click.



**Step 3** Pull cables outwards to confirm whether they are fastened firmly.

**Step 4** Connect the other end to the DRED / Ripple Control Receiver / NS Protection device.

-- End

## 6.12 Backup Connection

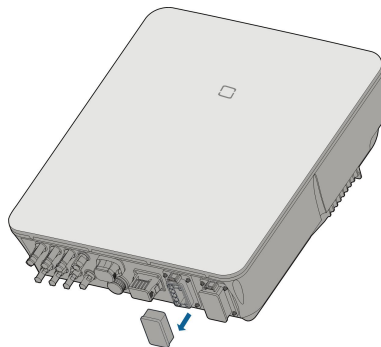
### Procedure

**Step 1** Assembling the BACK-UP Connector. Specifically, refer to "[6.5.2 Assembling the AC Connector](#)".



The PE wire of Backup terminal is not required for Australia and New Zealand.

**Step 2** Remove the waterproof lid from the **BACK-UP** terminal.



**Step 3** Align the Backup connector and the **BACK-UP** terminal and mate them together by hand until a "Click" is heard or felt.





**Step 4** Pull all the lines outward to check whether they are firmly installed.

-- End

# 7 Commissioning

## 7.1 Inspection before Commissioning

Check the following items before starting the inverter:

- The inverter DC switch and external circuit breaker are disconnected.
- The inverter should be accessible for operation, maintenance and service.
- Nothing is left on the top of the inverter.
- The inverter is correctly connected to the external devices, and the cables are routed in a safe place or protected against mechanical damage.
- The selection of the AC circuit breaker is in accordance with this manual and all applicable local standards.
- All unused terminals at the bottom of the inverter are properly sealed.
- Warning signs & labels are intact and legible.

## 7.2 Commissioning Procedure

If all of the items mentioned above meet the requirements, proceed as follows to start up the inverter for the first time.

**Step 1** Connect the AC circuit breaker.

**Step 2 (Optional)** Connect the external DC circuit breaker between the inverter and the battery pack if a battery is equipped.

**Step 3 (Optional)** Power on the battery pack manually if a battery is equipped.

**Step 4** Rotate the DC switch to “ON”. The DC switch may be integrated in the inverter or installed by the customer, wait for at least 5 minutes.

**Step 5** Establish communication connection between the mobile phone and WiFi wireless communication module, and then set initial protection parameters. For details, please refer to "[8.3.2 Login Steps](#)"~ "[8.4 Initial Settings](#)". If the irradiation and grid conditions meet requirements, the inverter will normally operate. The connection time for inverter to grid may take some minutes or even to more according to different country code chosen in the initial settings and the real site grid condition.

**Step 6** Observe the LED indicator to ensure that the inverter operates normally. (Refer to "[Table 2-2 LED indicator description](#)").

-- End

# 8 iSolarCloud App

## 8.1 Brief Introduction

The iSolarCloud App can establish communication connection to the inverter via the WLAN, providing remote monitoring, data logging and near-end maintenance on the inverter. Users can also view inverter information and set parameters through the App.

\* To achieve direct login via WLAN, the WiFi wireless communication module developed and manufactured by SUNGROW is required. The iSolarCloud App can also establish communication connection to the inverter via wired Ethernet connection.



- This manual describes only how to achieve near end maintenance via WLAN direct connection.
- Screenshots in this manual are based on the V2.1.6 App for Android system, and the actual interfaces may differ.

## 8.2 Download and Install

### Method 1

Download and install the App through the following application stores:

- MyApp (Android, mainland China users)
- Google Play (Android, users other than mainland China ones)
- App store (iOS)

### Method 2

Scan the following QR code to download and install the App according to the prompt information.



The App icon appears on the home screen after installation.



iSolarCloud

## 8.3 Login

### 8.3.1 Requirements

The following items should meet requirements:

- The AC and DC sides or the AC side of the inverter is powered-on.
- The WLAN function of the mobile phone is enabled.
- The mobile phone is within the coverage of the wireless network produced by the of the WiFi module.

### 8.3.2 Login Steps

**Step 1** Connect the mobile phone to the WLAN network named as "SG-WiFi Module Serial Number" (the serial number is on the side of the WiFi module).

**Step 2** Open the App to enter the login screen, and tap "Local Access" to enter the next screen.

**Step 3** Select "WLAN", enter the password, and tap "LOGIN".



The default account is "user" and the initial password is "pw1111" which should be changed for the consideration of account security.

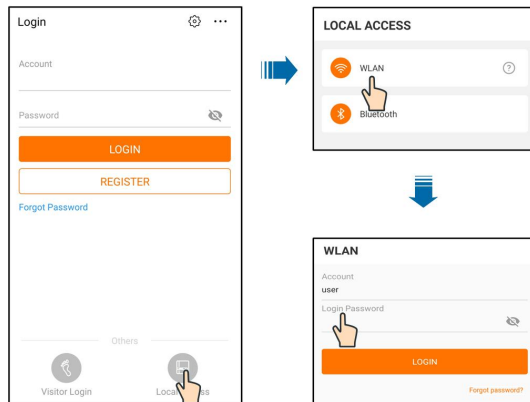
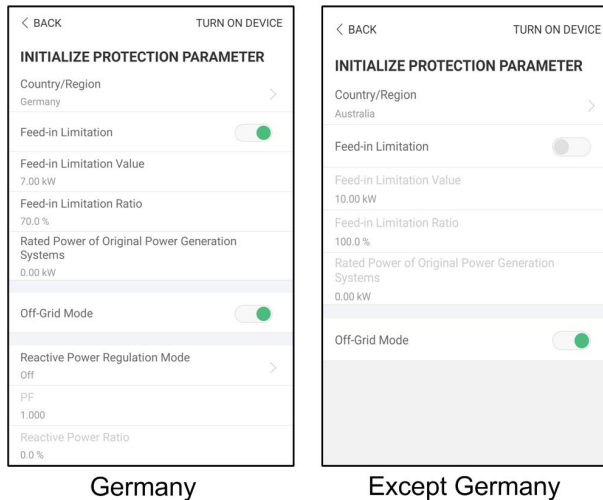


Figure 8-1 WLAN Direct

**Step 4** If the inverter is not initialized, navigate to the quick setting screen to initialize protection parameter. For details, please refer to "8.4 Initial Settings".



**NOTICE**

The "Country /Region" must be set to the country where the inverter is installed. Otherwise, the inverter may report errors.

**Step 5** After finishing settings, tap "TURN ON DEVICE" at the top right corner and the device will be initialized. The App will send start instructions and the device will start and operate.

**Step 6** After initialization settings, the App will return automatically to the home page.

-- End

## 8.4 Initial Settings

### 8.4.1 Feed-in Limitation

The function of the feed-in limitation is to control the amount of power injected in the grid by the plant. In some situations, this function is also called as "Export limitation" or "Zero export". The feed-in limitation function requires the using of Smart Energy Meter. Without the Smart Energy Meter, the feed-in limitation function will be unavailable.

Table 8-1 Description of feed-in limitation parameters

Parameter	Default value		Range
	Germany	Others	
Feed-in Limitation	On	Off	On / Off
Feed-in Limitation Value	Rated power × 70% <sup>*</sup>	Rated power	0 ~ Rated power
Feed-in Limitation Ratio	70.0% <sup>*</sup>	100.0%	0 ~ 100%
Rated Power of Original Power Generation Systems	Depends on inverter power of other companies		

<sup>\*</sup>If power control is regulated by a third party logger, please enable the power limitation to 100% in default.

### 8.4.2 Off-grid Mode

The off-grid mode is off by default, the user can set an amount of "Reserved Battery SOC for Off-Grid". The reserved battery SOC for Off-Grid is the minimum battery level in the on-grid state. The reserved battery SOC for Off-Grid will be supplied to the Backup loads in case of grid blackout.

### 8.4.3 Reactive Power Regulation Mode

The inverter provides a reactive power regulation function. Use the "Reactive Power Regulation Mode" parameter to activate this function and select proper regulation mode.

Table 8-2 Descriptions of reactive power regulation mode:

Mode	Descriptions
Off	The PF is fixed at +1.000.
PF	The reactive power can be regulated by the parameter PF (Power Factor).
Q(t)	The reactive power can be regulated by the parameter Q-Var limits (in %).

Mode	Descriptions
Q(P)	The PF changes with the output power of the inverter.
Q(U)	The reactive power changes with the grid voltage.

#### “ Off ” Mode

The reactive power regulation function is disabled. The PF is limited to +1.000.

#### “ PF ” Mode

The power factor is fixed and reactive power setpoint is calculated according to the current power. The PF ranges from 0.8 leading to 0.8 lagging.

Leading: the inverter is sourcing reactive power to the grid.

Lagging: the inverter is injecting reactive power into the grid.

#### “ Q(t) ” Mode

In the Q(t) mode, system rated reactive power is fixed, and the system injects reactive power according to the delivered reactive power ratio. The "Reactive Power Ratio" is set through the App.

The setting range of the reactive power ratio is 0~100% or 0~-100%, corresponding to the ranges of inductive and capacitive reactive power regulation respectively.

#### “ Q(P) ” Mode

The PF of the inverter output varies in response to the output power of the inverter.

Table 8-3 “ Q(P) ” Mode Parameter Descriptions:

Parameter	Explanation	Default		Range
		DE	AU	
Q(P) Curve	Select corresponding curve according to local regulations	A		A, B, C*
QP_P1	Output power at P1 on the Q(P) mode curve (in percentage)	20%	25%	10% ~ 100%
QP_P2	Output power at P2 on the Q(P) mode curve (in percentage)	50%		20% ~ 100%
QP_P3	Output power at P3 on the Q(P) mode curve (in percentage)	100%		20% ~ 100%
QP_K1	Power factor at P1 on the Q(P) mode curve	1		Curve A/C: 0.8~1 Curve B: -0.6~0.6
QP_K2	Power factor at P2 on the Q(P) mode curve	1		
QP_K3	Power factor at P3 on the Q(P) mode curve	0.95	0.90	
QP_EnterVoltage	Voltage percentage for Q(P) function activation	105%		100% ~ 110%
QP_ExitVoltage	Voltage percentage for Q(P) function deactivation	100%		90% ~ 100%

Parameter	Explanation	Default		Range
		DE	AU	
QP_ExitPower	Power percentage for Q(P) function deactivation	20%		1% ~ 20%
QP_EnableMode	Unconditional activation/deactivation of Q(P) function	Yes		Yes / No

\* Curve C is reserved and consistent with Curve A currently.

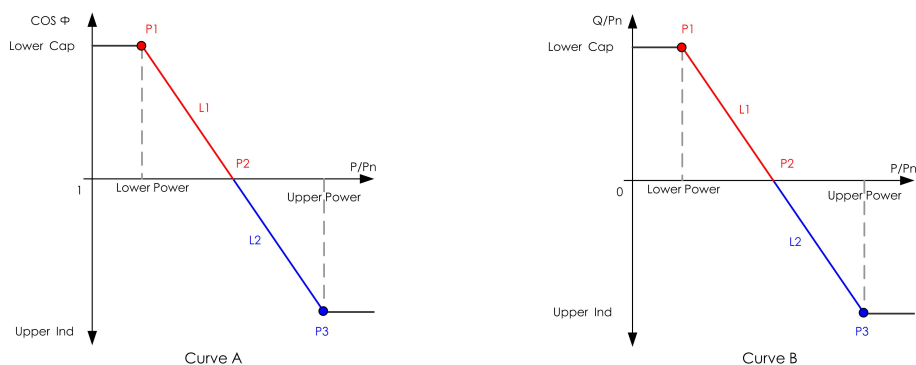


Figure 8-2 Q(P) Curve

### “Q(U)” Mode

The reactive power output of the inverter will vary in response to the grid voltage.

Table 8-4 “Q(U)” Mode Parameter Descriptions:

Parameter	Explanation	Default		Range
		DE	AU	
Q(U) curve	Select corresponding curve according to local regulations		A	A, B, C*
Hysteresis Ratio	Voltage hysteresis ratio on the Q(U) mode curve		0	0 ~ 5%
QU_V1	Grid voltage limit at P1 on the Q(U) mode curve	93%	90%	80% ~ 100%
QU_Q1	Value of Q/Sn at P1 on the Q(U) mode curve	-60%	-30%	-60% ~ 0
QU_V2	Grid voltage limit at P2 on the Q(U) mode curve	97%	95.6%	80% ~ 110%
QU_Q2	Value of Q/Sn at P2 on the Q(U) mode curve		0	-60% ~ 60%
QU_V3	Grid voltage limit at P3 on the Q(U) mode curve	103-%	AU:108.7% NZ:108.6%	100% ~ 120%
QU_Q3	Value of Q/Sn at P3 on the Q(U) mode curve		0	-60% ~ 60%
QU_V4	Grid voltage limit at P4 on the Q(U) mode curve	107-%	AU:115.2% NZ:110.8%	100% ~ 120%



Parameter	Explanation	Default		Range
		DE	AU	
QU_Q4	Value of Q/Sn at P4 on the Q(U) mode curve	60%	30%	0 ~ 60%
QU_EnterPower	Active power for Q(U) function activation		80%	20% ~ 100%
QU_ExitPower	Active power for Q(U) function deactivation		10%	1% ~ 20%
QU_EnableMode	Unconditional activation/ deactivation of Q(U) function		Yes	Yes / No / Yes, Limited by PF

\* Curve C is reserved and consistent with Curve A currently.

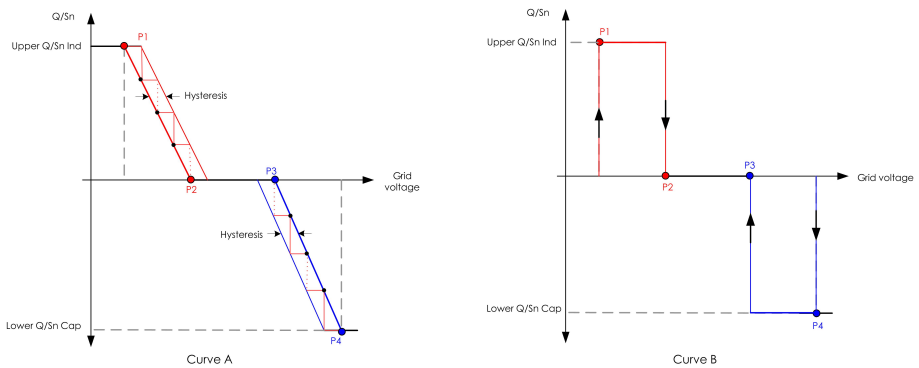


Figure 8-3 Q(U) Curve

## 8.5 Function Overview

The App provides parameter viewing and setting functions, as shown in the following figure.

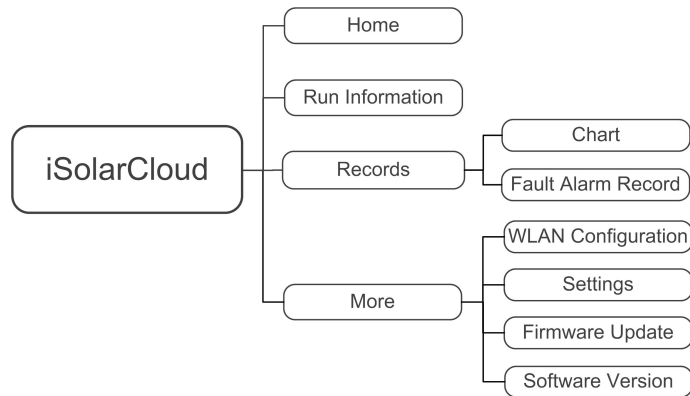


Figure 8-4 App Function Tree Map

## 8.6 Home

Home page of the App is shown in the following figure.

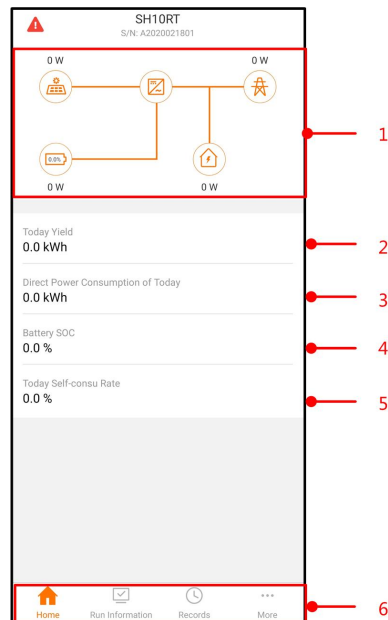



Figure 8-5 Home

Table 8-5 Home page description

No.	Name	Description
1	Load flow chart	Shows the PV power generation power, feed-in power, etc. The line with an arrow indicates energy flow between connected devices, and the arrow pointing indicates energy flow direction.
2	Today yield	Shows today power generation of the inverter

No.	Name	Description
3	Direct Power Consumption of Today	Shows electricity directly consumed by loads today
4	Battery SOC	Indicates remaining battery capacity
5	Today Self-consu Rate	Indicates today self-consumption rate of the PV system
6	Navigation bar	Includes menus of "Home", "Run Information", "-Records", and "More".

If the inverter runs abnormally, the fault icon  appears on the upper left corner of the screen. Users can tap the icon to view detailed fault information and corrective measures.

## 8.7 Run Information

Tap "Run Information" on the navigation bar to enter the corresponding screen, as shown in the following figure.

RUN INFORMATION	
PV Information ^	
String 1 Voltage	0.0 V
String 1 Current	0.00 A
String 2 Voltage	0.0 V
String 2 Current	0.00 A
Daily PV Yield	0.0 kWh
Total PV Yield	0.0 kWh
Inverter Information ^	
Running Status	
Shut Down	
Bus Voltage	0.0 V
Internal Air Temperature	24.9 °C
Array Insulation Resistance	0 kΩ
Country (Region) Information	
Germany	
Ripple Control state	
No RIPP Schedule	
Power Limitation Mode	
Unlimited Power	

Figure 8-6 Run Information

The run information includes the PV information, inverter information, input, output, grid information, load information, and battery information.

## 8.8 Records

Tap "Records" on the navigation bar to enter the screen, as shown in the following figure.

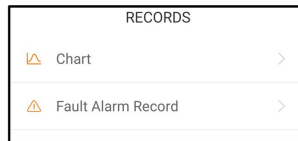


Figure 8-7 Records

On “Records ” screen, users can view chart and check fault alarm record.

### 8.8.1 Chart

Tap "Chart" to enter the screen showing daily power generation, as shown in the following figure.

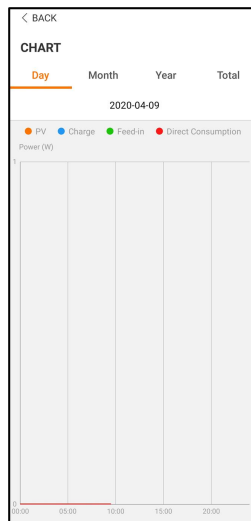


Figure 8-8 Power Curve

The App displays power generation records in a variety of forms, including daily power generation graph, monthly power generation histogram, annual power generation histogram, and total power generation histogram.

Table 8-6 Description of power generation records

Item	Description
Daily power generation graph	Indicates today power generation, charging, feed-in power, and direct consumption power
Monthly power generation histogram	Indicates monthly power generation, charging, feed-in power, and direct consumption power

Item	Description
Annual power generation histogram	Indicates annual power generation, charging, feed-in power, and direct consumption power
Total power generation histogram	Indicates total power generation, charging, feed-in power, and direct consumption power

## 8.8.2 Fault Alarm Record

Tap "Fault Alarm Record " to enter the screen, as shown in the following figure.

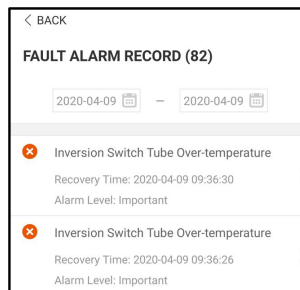


Figure 8-9 Fault Alarm Record



Click "📅" to select a time segment and view corresponding records.

Select one of the records in the list and click the record, to view the detailed fault info as shown in following figure.

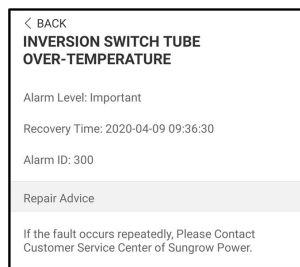


Figure 8-10 Detailed fault alarm info

## 8.9 More

Tap "More" on the navigation bar to enter the screen, as shown in the following figure.

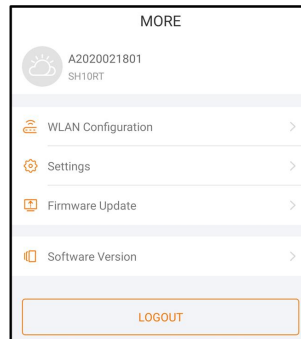
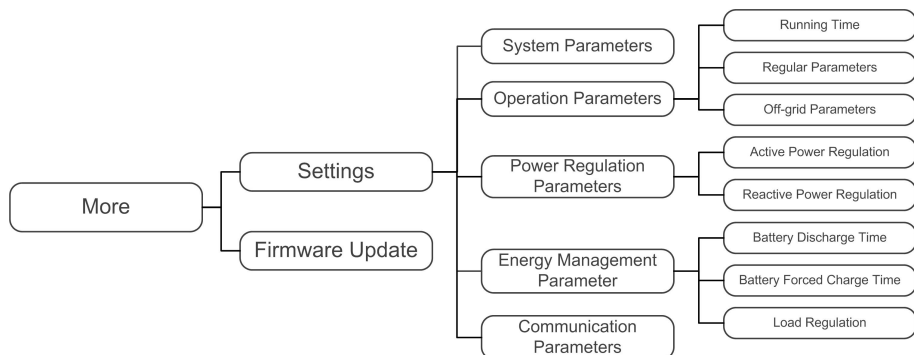


Figure 8-11 More



The "More" screen supports the following operations:

- Set parameters including inverter system parameters and energy management parameter.
- Upgrade inverter firmware (ARM/DSP/PVD/CPLD).

### 8.9.1 System Parameters

Tap "Settings -> System Parameters" to enter the screen, as shown in the following figure.

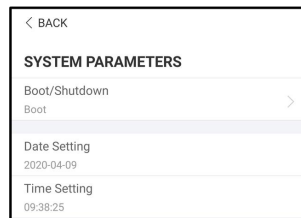


Figure 8-12 System Parameters

#### Boot/Shutdown

Tap "Boot/Shutdown", on which boot/shutdown instruction can be sent to the inverter. For Australia and New Zealand, when the DRM state is DRM0, the "Boot" option will be prohibited.

## System Time

The correct system time is very important. Wrong system time will directly affect the data logging and power generation value. The clock is in 24-hour format.

### 8.9.2 Running Time

Tap "Settings -> Operation Parameters -> Running Time" to enter the corresponding screen, on which you can set "Connecting Time" and "Reconnecting Time".

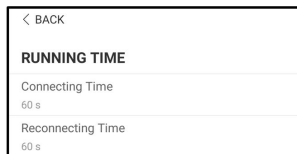


Figure 8-13 Running Time

Table 8-7 Description of running time parameters

Parameter	Explanation	Default	Range
Connecting Time	The time that the inverter takes to enter into the running mode from the standby mode in fault-free state	60s	20s ~ 900s
Reconnecting Time	The time that the inverter takes to recover from the fault state to normal state (the inverter is not running)	60s	0s ~ 3600s

### 8.9.3 Regular Parameters

Tap "Settings -> Operation Parameters -> Regular Parameters" to enter the screen, as shown in the following figure.

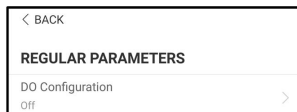


Figure 8-14 Regular Parameters

After connecting the load to the DO terminals, a relay control signal will be transmitted. Users can flexibly set the control mode of DO configuration according to individual demand.

Table 8-8 The control mode of DO configuration

Mode	Setting description
Off	-
Load 1 Regulation Mode	See "8.9.9 Load Regulation"
Grounding Detection	See "8.9.12 Grounding Detection"

### 8.9.4 Off-grid Parameters

Tap "Settings -> Operation Parameters -> Off-grid Parameters" to enter the screen, as shown in the following figure.

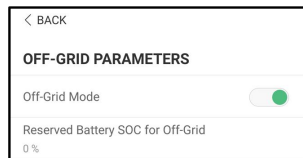


Figure 8-15 Off-grid Parameters

Refer to the description in "8.4.2 Off-grid Mode".

### 8.9.5 Active Power Regulation

Tap "Settings -> Power Regulation Parameters -> Active Power Regulation" to enter the screen, as shown in the following figure.

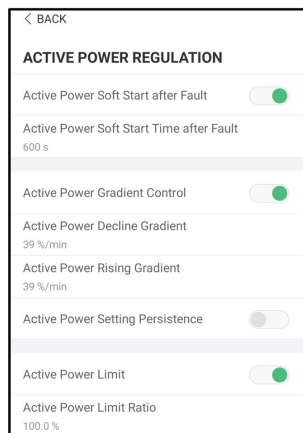


Figure 8-16 Active Power Regulation

Table 8-9 Description of active power regulation

Parameter	Description	Default	Range
Active Power Soft Start after Fault	Switch for activating/deactivating the function of active power soft start after a fault occurs	On	On/Off
Active Power Soft Start Time after Fault	The soft start time required for raising active power from 0 to rated value after a fault occurs	600s	1s ~ 1200s
Active Power Gradient Control	Set whether to enable active power gradient control	On	On/Off
Active Power Decline Gradient	Decline gradient of inverter active power per minute	39%/min	3%/min ~ 6000%/min
Active Power Rising Gradient	Rising gradient of inverter active power per minute	39%/min	6000%/min



Parameter	Description	Default	Range
Active Power Setting Persistence	Switch for activating/deactivating the function of active power setting persistence	Off	On/Off
Active Power Limit	Switch for limiting active power	On	On/Off
Active Power Limit Ratio	The ratio of active power limit to rated power in percentage	100.0%	0 ~ 110%

### 8.9.6 Reactive Power Regulation

Tap "Settings -> Power Regulation Parameters -> Reactive Power Regulation" to enter the screen, as shown in the following figure.



Figure 8-17 Reactive Power Regulation

Table 8-10 Description of reactive power regulation

Parameter	Description	Default	Range
Reactive Power Setting Persistence	Switch for activating/deactivating the function of reactive power setting persistence	On	On / Off
Reactive Power Regulation Mode	See " <a href="#">8.4.3 Reactive Power Regulation Mode</a> "	-	-
Reactive Power Regulation	Switch for activating/deactivating reactive power regulation function	On	On / Off
Reactive Power Regulation Time	Time taken for reactive power regulation	10.0 s	0.1 s ~ 600.0 s

### 8.9.7 Battery Discharge Time

Tap "Settings -> Energy Management Parameter-> Battery Discharge Time" to enter the corresponding screen, as shown in the following figure.

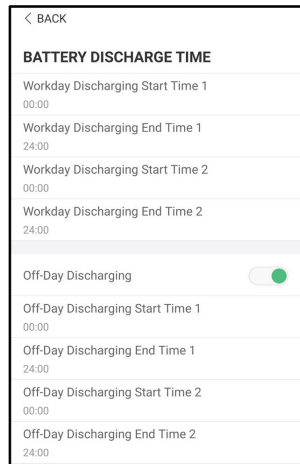


Figure 8-18 Battery Discharge Time

### 8.9.8 Battery Forced Charge Time

Tap "Settings -> Energy Management Parameter-> Battery Forced Charge Time" to enter the corresponding screen.

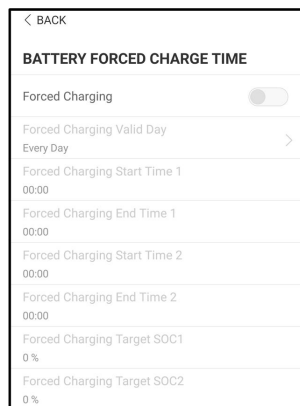


Figure 8-19 Battery Forced Charge Time

When there is no PV power, the power imported from the grid charges the energy system during the time period until the target SOC is reached.

It is recommended to set the time period in off-peak tariff time. The time period 1 is in priority to the time period 2 if two periods overlap. The charging energy comes from the excess PV energy in priority and then from the grid. The inverter will take charging power from the grid in the case of PV energy shortage.

### 8.9.9 Load Regulation

Tap "Settings -> Energy Management Parameter-> Load Regulation" to enter the corresponding screen, on which you can set "Load 1 Regulation Mode". Load 1 Regulation Mode includes "Timing Mode", "Switch Mode", and "Intelligent Mode".

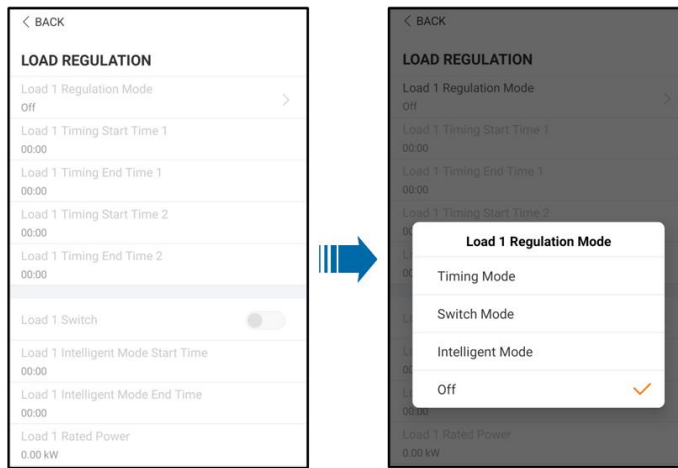


Figure 8-20 Load Regulation

**Timing Mode**

In this mode, set the "Load 1 Timing Start Time" and "Load 1 Timing End Time", the system will control the load operation during the interval. Take 09:00 am – 09:30 am as an example.

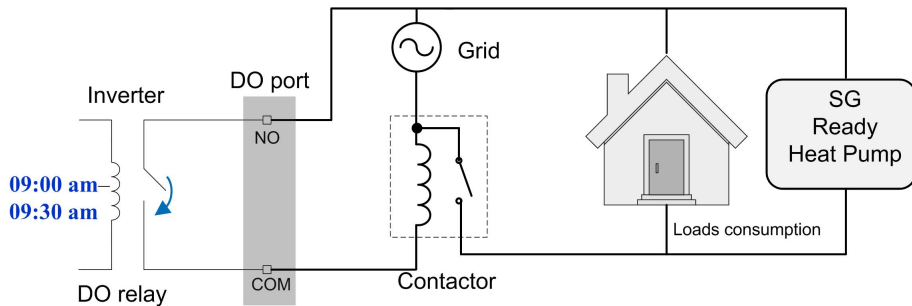


Figure 8-21 DO Operation in Timing Mode

**Switch Mode**

In this mode, the system will control the load operation according to the setting. In the following example, the switch is set to OFF.

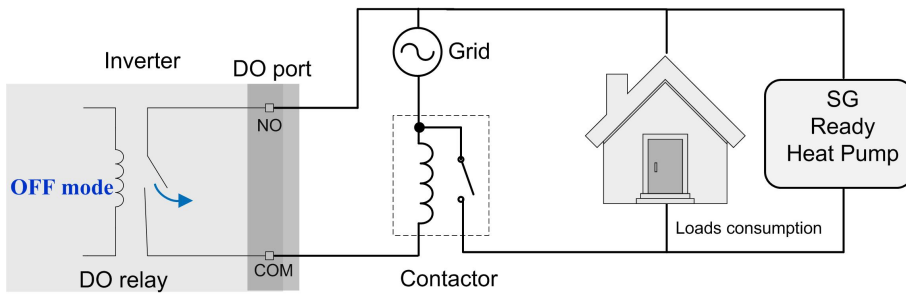


Figure 8-22 DO Operation in Switch Mode

### Intelligent Mode

The system will control the load operation according to the power optimization algorithm of energy management.

During the setting interval, the DO function will be enabled to power on the load if the excess PV energy exceeds the optimized power value.

Notice:

The intelligent mode is disabled in an off-grid system.

- When the inverter is installed to retrofit an existing PV system, the upper limit of optimized power is the sum of the rated power of the hybrid inverter and the rated power of the existing PV inverter.
- Once the intelligent mode is enabled, the DO relay will remain connected for 20 minutes after the DO connection.

Take 09:00 am – 09:30 am and the optimized power of 1000 W as an example.

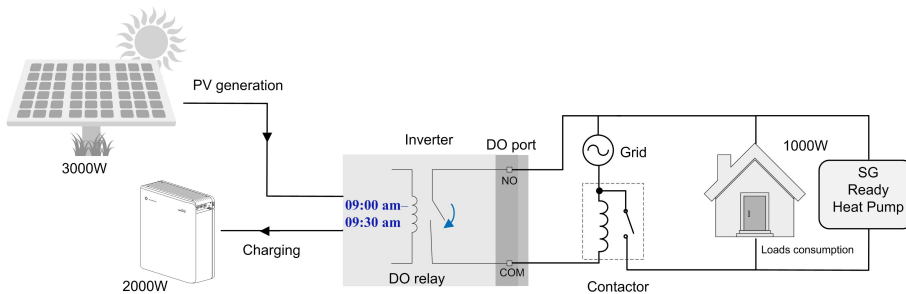


Figure 8-23 DO Operation in Intelligent Mode

### 8.9.10 Communication Parameters

Tap "Settings -> Communication Parameters" to enter the screen, as shown in the following figure.

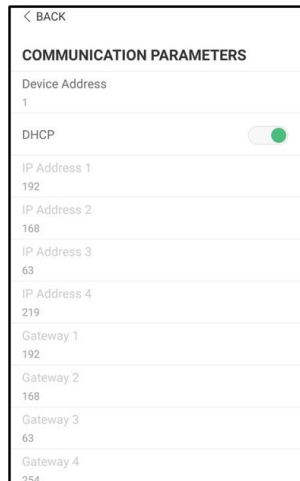



Figure 8-24 Communication Parameters

- The device address ranges from 1 to 246.
- The IP address, gateway, subnet mask, preferred DNS server and alternate DNS server can be modified only when the DHCP is set to Off.
- Acquire the IP address, gateway, subnet mask, preferred DNS server and alternate DNS server from the network professional.

### 8.9.11 Firmware Update

#### Preparation of firmware upgrade package

Tap the icon  in the upper right corner of the login screen and select "Firmware Download", to enter the "File List" tab. Select the desired upgrade package (.zip).

Tap the icon . The downloaded package can be found in the "Downloaded" tab.

#### Upgrade

Tap "Firmware Update" to enter the corresponding screen, as shown in the following figure.

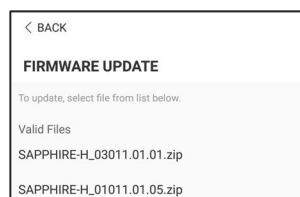


Figure 8-25 Firmware upgrade

Select the desired upgrade package to upgrade the firmware.

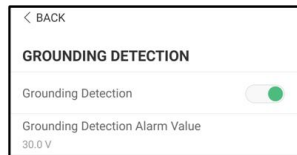
## 8.9.12 Grounding Detection



Contact SUNGROW to obtain the advanced account and corresponding password before setting the earth detection parameters.

Unauthorized personnel are not allowed to log in with this account. Otherwise, SUNGROW shall not be held liable for any damages caused.

Tap "More -> Settings -> Operation ParameterS -> Grounding Detection" to enter the corresponding screen.



**Figure 8-26** Grounding Detection

If the grounding detection is enabled, the DO relay will switch on automatically to signal the external alarm if the value exceeds the grounding detection alarm value. The buzzer inside the inverter will beep.

The PV insulation resistance fault (fault sub-code 039) will trigger the DO relay to signal the external alarm.

## 9 System Decommissioning

### 9.1 Decommissioning the Inverter

#### NOTICE

Please strictly follow the following procedure. Otherwise it will cause lethal voltages or unrecoverable damage to the inverter.

#### 9.1.1 Disconnecting the Inverter

For maintenance or other service work, the inverter must be switched off.

Proceed as follows to disconnect the inverter from the AC and DC power sources. Lethal voltages or damage to the inverter will follow if otherwise.

**Step 1** Stop the inverter via the iSolarCloud App. For details, see "[8.9.1 System Parameters](#)".

**Step 2** Disconnect the external AC circuit breaker and secure it against reconnection.

**Step 3** Rotate the DC switch to the "OFF" position and then disconnect all of the PV string inputs.

**Step 4** Disconnect the DC circuit breaker between the battery and the inverter.

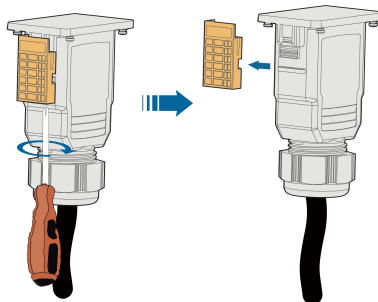
#### NOTICE

Do not power on the system again for 1 minute after the disconnection.

**Step 5** Wait about 10 minutes until the capacitors inside the inverter completely discharge.

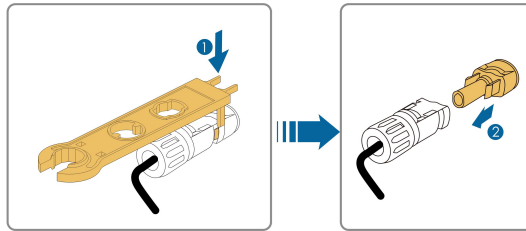
**Step 6** Measure and ensure that no voltage is present at the AC output on the inverter.

**Step 7 (Optional)** Remove the protection block with a Phillips screwdriver.



**Step 8** Insert the Slotted screwdriver into one of the two openings and press the screwdriver with an appropriate force to remove the AC connector.

**Step 9** Insert a MC4 wrench into the notch and press the wrench with an appropriate force to remove the DC connector.



**Step 10** Use the multimeter to measure the port voltage of the battery. Disconnect the power cables after the voltage is zero.

-- End

### 9.1.2 Dismantling the Inverter

#### **CAUTION**

Risk of burn injuries and electric shock!

Do not touch any inner live parts for 10 minutes after disconnecting the inverter from the utility grid, the PV inputs and the battery module.

**Step 1** Refer to "Electrical Connection" for the inverter disconnection of all cables in reverse steps.

**Step 2** Dismantle the inverter referring to "Mechanical Mounting" in reverse steps.

**Step 3** If necessary, remove the wall-mounting bracket from the wall.

**Step 4** If the inverter will be reinstalled in the future, please refer to "Inverter Storage" for a proper conservation.

-- End

### 9.1.3 Disposal of the Inverter

Users take the responsibility for the disposal of the inverter.

#### **NOTICE**

Some parts and devices of the inverter, such as the capacitors, may cause environment pollution.

Do not dispose of the product together with household waste but in accordance with the disposal regulations for electronic waste applicable at the installation site.



## 9.2 Decommissioning the Battery

Decommission the battery in the system after the inverter is decommissioned. Proceed as follows to decommission a Li-ion battery.

**Step 1** Disconnect the DC circuit breaker between the battery and the inverter.

**Step 2** Disconnect the communication cable between the battery and the inverter.

**Step 3 (Optional)** Turn off the switch on LG Li-ion battery or BYD Li-ion battery, if applicable.

**Step 4** Wait for about 1 minute and then use the multimeter to measure the port voltage of the battery.

**Step 5** If the battery port voltage is zero, disconnect the power cables from the battery module.

-- End



SUNGROW is not liable for disposal of the battery.

# 10 Troubleshooting and Maintenance

## 10.1 Troubleshooting

When an alarm occurs, the alarm information can be viewed through the App.

Alarm ID and corrective measures are as follows:

Alarm ID	Alarm Name	Corrective Measures
001	Grid overvoltage	<p>Generally, the inverter will be reconnected to the grid after the grid recovers. If the alarm occurs frequently:</p> <ol style="list-style-type: none"><li>1. Measure the grid voltage, and contact the local utility grid company for solutions if the grid voltage exceeds the specified value.</li><li>2. Check, through the App, whether the protection parameters are appropriately set.</li><li>3. Check whether the cross-sectional area of the AC cable meets the requirement.</li><li>4. If the alarm persists, contact SUNGROW.</li></ol>
002	Grid undervoltage	<p>Generally, the inverter will be reconnected to the grid after the grid recovers. If the alarm occurs frequently:</p> <ol style="list-style-type: none"><li>1. Measure the grid voltage, and contact the local utility grid company for solutions if the grid voltage is below the specified value.</li><li>2. Check, through the App, whether the protection parameters are appropriately set.</li><li>3. Check whether the AC cable is firmly in place.</li><li>4. If the alarm persists, contact SUNGROW.</li></ol>

Alarm ID	Alarm Name	Corrective Measures
003	Grid overfrequency	<p>Generally, the inverter will be reconnected to the grid after the grid recovers. If the alarm occurs frequently:</p> <ol style="list-style-type: none"> <li>1. Measure the grid frequency, and contact the local utility grid company for solutions if the grid frequency is beyond the specified range.</li> </ol>
004	Grid underfrequency	<ol style="list-style-type: none"> <li>2. Check, through the App, whether the protection parameters are appropriately set.</li> <li>3. If the alarm persists, contact SUNGROW.</li> </ol>
005	No Grid	<p>Generally, the inverter will be reconnected to the grid after the grid recovers. If the alarm occurs frequently:</p> <ol style="list-style-type: none"> <li>1. Check whether the grid supplies power reliably.</li> <li>2. Check whether the AC cable is firmly in place.</li> <li>3. Check whether the AC cable is correctly connected (whether the live wire and the N wire are in correct place).</li> <li>4. Check whether the AC switch or circuit breaker is disconnected.</li> <li>5. If the alarm persists, contact SUNGROW.</li> </ol>
006	Overhigh leakage current	<ol style="list-style-type: none"> <li>1. The alarm can be caused by poor sunlight or damp environment, and the inverter will be reconnected to the grid after the environment is improved.</li> <li>2. If the environment is normal, check whether the AC and DC cables are well insulated.</li> <li>3. If the alarm persists, contact SUNGROW.</li> </ol>
007	Grid abnormal	<p>Generally, the inverter will be reconnected to the grid after the grid recovers. If the alarm occurs frequently:</p> <ol style="list-style-type: none"> <li>1. Measure the grid frequency, and contact the local utility grid company for solutions if the grid frequency exceeds the specified value.</li> <li>2. If the alarm persists, contact SUNGROW.</li> </ol>

Alarm ID	Alarm Name	Corrective Measures
008	Grid voltage unbalance	<p>Generally, the inverter will be reconnected to the grid after the grid recovers. If the alarm occurs frequently:</p> <ol style="list-style-type: none"> <li>1. Measure the grid voltage. If grid phase voltage differs greatly, contact the utility grid company for solutions.</li> <li>2. If the voltage difference between the three phases is within the permissible range of the local utility grid company, modify the parameter setting through the App.</li> <li>3. If the alarm persists, contact SUNGROW.</li> </ol>
009	PV reverse connection fault	<ol style="list-style-type: none"> <li>1. Check whether the corresponding string is of reverse polarity. If so, disconnect the DC switch and adjust the polarity when the solar radiation is low and the string current drops below 0.5A.</li> </ol>
010	PV reverse connection alarm	<ol style="list-style-type: none"> <li>2. Check whether PV strings connected to the same MPPT have the same number of PV modules. If not, take corrective measures.</li> <li>3. If the alarm persists, contact SUNGROW.</li> </ol>
011	PV abnormal alarm	<ol style="list-style-type: none"> <li>1. Check whether there is PV module shaded. If so, remove the shade and ensure the PV module is clean.</li> <li>2. Check whether the PV module is in abnormal aging.</li> <li>3. If the alarm persists, contact SUNGROW.</li> </ol>
012	High ambient temperature	<ol style="list-style-type: none"> <li>1. Check whether the inverter is directly exposed to sunlight. If so, take some shading measures.</li> <li>2. Check and clean the air ducts.</li> <li>3. Check whether the sub-alarm ID 070 (fan alarm) occurs through the App. If so, replace the faulty fan.</li> <li>4. If the alarm persists, contact SUNGROW.</li> </ol>
013	Low ambient temperature	<p>Stop and disconnect the inverter. Restart the inverter when the ambient temperature is within the permissible range.</p>

Alarm ID	Alarm Name	Corrective Measures
014	Low ISO resistance	<p>Wait for the inverter to recover. If the fault occurs frequently:</p> <ol style="list-style-type: none"> <li>1. Check whether the insulation resistance protection value is extremely large through the App, and ensure that it complies with the local regulations.</li> <li>2. Check the resistance to ground from the PV module/cable. Take corrective measures in case of leading to short circuit or damaged insulation layer.</li> <li>3. If the cable is normal and the alarm occurs on rainy days, check it again when the weather turns fine.</li> <li>4. If the fault occurs on a cloudy day without rain but there is stagnant water or vegetation on site, clear the water and vegetation. If the fault persists, check it again when the weather turns fine.</li> <li>5. If the alarm persists, contact SUNGROW.</li> </ol>
015	Grounding cable fault	<ol style="list-style-type: none"> <li>1. Check whether the AC cable is correctly connected.</li> <li>2. Check whether the grounding cable and wire cores are wrongly insulated.</li> <li>3. If the alarm persists, contact SUNGROW.</li> </ol>
016	Arc fault	<ol style="list-style-type: none"> <li>1. Disconnect the DC inputs and check whether DC cables are damaged, whether the wiring terminals or fuses, if necessary, are loose or in poor contact, and whether there is PV module burnt. If so, take corresponding corrective measures.</li> <li>2. After taking corresponding measures in step 1, reconnect the DC inputs. Remove the arc fault through the App, and therefore the inverter will recover.</li> <li>3. If the alarm persists, contact SUNGROW.</li> </ol>
017	Off-grid load overpower	<ol style="list-style-type: none"> <li>1. Reduce the power of loads connected at the off-grid port, or remove some loads.</li> <li>2. If the alarm persists, contact SUNGROW.</li> </ol>

Alarm ID	Alarm Name	Corrective Measures
018	Reverse Smart Energy Meter connection	<ol style="list-style-type: none"> <li>1. Check whether the polarity of the Smart Energy Meter is reversed according to the prints on the cable connection port, and correct the connection if necessary.</li> <li>2. Check whether the Smart Energy Meter is connected to a wrong terminal, instead of the grid-connected point. If so, correct it.</li> <li>3. If the alarm persists, contact SUNGROW.</li> </ol>
019	Smart Energy Meter communication error	<ol style="list-style-type: none"> <li>1. Check whether the Smart Energy Meter communication cable and terminal are abnormal. If so, remove the corresponding abnormality.</li> <li>2. Reconnect the Smart Energy Meter communication cable.</li> <li>3. If the alarm persists, contact SUNGROW.</li> </ol>
020	Grid confrontation	<ol style="list-style-type: none"> <li>1. Check whether the AC output port is connected to the actual grid. If so, disconnect it.</li> <li>2. If the alarm persists, contact SUNGROW.</li> </ol>
021	Parallel communication alarm	<ol style="list-style-type: none"> <li>1. Check whether the communication cable and corresponding wiring terminal are abnormal. If so, take corrective measures to ensure reliable connection.</li> </ol>
022	BMS communication error	<ol style="list-style-type: none"> <li>2. Reinstall the Smart Energy Meter communication cable.</li> <li>3. If the alarm persists, contact SUNGROW.</li> </ol>
023	Battery polarity reversed	<ol style="list-style-type: none"> <li>1. Check the battery for polarity correctness, and correct it if necessary.</li> <li>2. If the alarm persists, contact SUNGROW.</li> </ol>
024	Battery alarm	<p>Generally, the battery can automatically recover. In case the alarm persist for a long time:</p> <ol style="list-style-type: none"> <li>1. If the alarm is caused by ambient temperature, such as over temperature alarm or low temperature alarm, take measures to change the ambient temperature, such as improving heat dissipation conditions.</li> <li>2. If the fault persists, contact battery manufacturer.</li> </ol>

Alarm ID	Alarm Name	Corrective Measures
025	Battery abnormal	<ol style="list-style-type: none"> <li>1. In case of abnormal battery voltage, check whether the battery real-time voltage is abnormal. If so, contact the battery manufacturer. If not, contact SUNGROW.</li> <li>2. In case of abnormal battery temperature, take measures to change the ambient temperature, such as improving heat dissipation conditions.</li> <li>3. If the fault persists, contact battery manufacturer.</li> </ol>
063	System alarm	<p>The inverter can operate normally.</p> <ol style="list-style-type: none"> <li>1. Check whether the related cable connection and terminals are abnormal, and check whether the ambient environment is abnormal. If so, take corrective measures.</li> <li>2. If the alarm persists, contact SUNGROW.</li> </ol>
064	System fault	<ol style="list-style-type: none"> <li>1. Wait for the inverter to recover.</li> <li>2. Disconnect the AC and DC switches or circuit breakers, and connect them again after 15 minutes.</li> <li>3. If the alarm persists, contact SUNGROW.</li> </ol>

## 10.2 Maintenance

### 10.2.1 Routine Maintenance

Item	Method	Period
General status of the system	<ul style="list-style-type: none"> <li>• Visual check for any damage or deformation of the inverter.</li> <li>• Check any abnormal noise during the operation.</li> <li>• Check each operation parameter.</li> <li>• Be sure that nothing covers the heat sink of the inverter.</li> </ul>	Every 6 months
Electrical connection	Check whether there is damage to the cables, especially the surface in contact with metal.	6 months after commissioning and then once or twice a year.

## 10.2.2 Replacing the Button Cell

** DANGER**

Disconnect the inverter from the grid first, then the PV strings and the battery before any maintenance work.

Lethal voltage still exists in the inverter. Please wait at least 10 minutes and then perform maintenance work.

There is a button cell on the inner PCB board. Contact SUNGROW for replacement when the relevant fault alarm occurs.

Check the fastener, appearance, voltage, and resistance quarterly and annually.



# 11 Appendix

## 11.1 Technical Data

Parameters	SH5.0RT	SH6.0RT
<b>PV Input</b>		
Max. PV input power	7500 W	9000 W
Max. PV input voltage	1000 V	1000 V
Startup voltage	180 V	250 V
Nominal input voltage	600 V	600 V
MPP voltage range	150 V...950 V	200 V...950 V
MPP voltage range for nominal power	210 V...850 V	250 V...850 V
No. of MPPTs	2	
Max. number of PV strings per MPPT	1 / 1	
Max. PV input current	25 A (12.5 A / 12.5 A)	
Max. current for input connector	16 A	
Short-circuit current of PV input	32A (16 A / 16 A)	
<b>Battery Data</b>		
Battery type	Li-ion battery	
Battery voltage	150 V...600 V	
Max. charge / discharge current*	30 A / 30 A	
Max. charge / discharge power	7500 W / 6000 W	9000 W / 7200W
<b>AC Input and Output Data</b>		
Nominal AC output power	5000 W	6000 W
Nominal AC output current	7.3 A	8.7 A
Max. input power from grid	12500 W	15000 W
Max. input current from grid	18.1 A	21.7 A
Max. AC output apparent power	5000 VA	6000 VA
Max. AC output current	7.6 A	9.1 A

Parameters	SH5.0RT	SH6.0RT
Nominal AC voltage	3 / N / PE, 220 / 380 V; 230 / 400 V; 240 / 415 V	
AC voltage range	270 Vac...480 Vac	
Nominal grid frequency	50 Hz / 60 Hz	
Grid frequency range	45 Hz...55 Hz / 55 Hz...65 Hz	
Total Harmonic Distortion (THD)	< 3 % (of nominal power)	
DC current injection	< 0.5 % I <sub>n</sub>	
Power factor	> 0.99 / 0.8 leading to 0.8 lagging	
<b>Protection</b>		
LVRT	Yes	
Anti-islanding protection	Yes	
AC short circuit protection	Yes	
Leakage current protection	Yes	
DC switch (solar)	Yes	
DC fuse (battery)	Yes	
Over-voltage category	III [Mains], II [PV] [Battery]	
SPD	DC Type II / AC Type II	
<b>System Data</b>		
Max. efficiency	98.4 %	98.4 %
Max. European efficiency	97.2 %	97.5 %
Isolation method (solar / battery)	Transformerless / Transformerless	
Ingress protection (IP) rating	IP65	
Operating ambient temperature range	-25 °C...60 °C	
Allowable relative humidity range (Non-condensing)	0...100 %	
Cooling method	Natural convection	
Max. operating altitude	4000 m (> 3000 m derating)	
Noise (Typical)	30 dB(A)	
Display	LED	
Communication	RS485, WLAN, Ethernet, CAN, 4 × DI, 1 × DO	
DC connection type	MC4 (PV) / Sunclix (Battery)	
AC connection type	Plug and play connector	
Compliance	IEC / EN 62109-1, IEC / EN 62109-2, IEC / EN 61000-6-1, IEC / EN 61000-6-3, IEC / EN 61000-3, EN 62477-1, VDE-AR-N-4105, AS/NZS 4777.2	

Parameters	SH5.0RT	SH6.0RT
<b>Mechanical Data</b>		
Dimensions (W x H x D)	460 mm x 540 mm x 170 mm	
Mounting method	Wall-mounting bracket	
Weight	27 kg	
<b>Backup Data</b>		
Nominal voltage	3 / N / PE, 220 Vac / 230 Vac / 240 Vac	
Frequency range	50 Hz / 60 Hz	
Total harmonic factor output voltage	2%	
Switch time to emergency mode	< 20 ms	
Nominal output power	5000 W / 5000 VA	6000 W / 6000 VA
Peak output power	6000 W / 6000 VA, 5min 10000 W / 10000 VA, 10 s	7200 W / 7200 VA, 5min 10000 W / 10000 VA, 10 s

\* Depending on the connected battery

Parameters	SH8.0RT	SH10RT
<b>PV Input</b>		
Max. PV input power	12000 W	15000 W
Max. PV input voltage	1000 V	
Startup voltage	250 V	
Nominal input voltage	600 V	
MPP voltage range	200 V...950 V	
MPP voltage range for nominal power	330 V...850 V	280 V...850 V
No. of MPPTs	2	
Max. number of PV strings per MPPT	1 / 1	1 / 2
Max. PV input current	25 A (12.5 A / 12.5 A)	37.5 A (12.5 A / 25 A)
Max. current for input connector	16 A	
Short-circuit current of PV input	32 A (16 A / 16 A)	48 A (16 A / 32 A)
<b>Battery Data</b>		
Battery type	Li-ion battery	
Battery voltage	150 V...600 V	

Parameters	SH8.0RT	SH10RT
Max. charge / discharge current*	30 A / 30 A	
Max. charge / discharge power	10600 W / 10600 W	
<b>AC Input and Output Data</b>		
Nominal AC output power	8000 W	10000 W
Nominal AC output current	11.6 A	14.5 A
Max. input power from grid	18600 W	20600 W
Max. input current from grid	27.0 A	30.0 A
Max. AC output apparent power	8000 VA	10000 VA
Max. AC output current	12.1 A	15.2 A
Nominal AC voltage	3 / N / PE, 220 / 380 V; 230 / 400 V; 240 / 415 V	
AC voltage range	270 Vac...480 Vac	
Nominal grid frequency	50 Hz / 60 Hz	
Grid frequency range	45 Hz...55 Hz / 55 Hz...65 Hz	
Total Harmonic Distortion (THD)	< 3 % (of nominal power)	
DC current injection	< 0.5 % I <sub>n</sub>	
Power factor	> 0.99 / 0.8 leading to 0.8 lagging	
<b>Protection</b>		
LVRT	Yes	
Anti-islanding protection	Yes	
AC short circuit protection	Yes	
Leakage current protection	Yes	
DC switch (solar)	Yes	
DC fuse (battery)	Yes	
Over-voltage category	III [Mains], II [PV] [Battery]	
SPD	DC Type II / AC Type II	
<b>System Data</b>		
Max. efficiency	98.4 %	98.4 %
Max. European efficiency	97.7 %	97.9 %
Isolation method (solar / battery)	Transformerless / Transformerless	
Ingress protection (IP) rating	IP65	
Operating ambient temperature range	-25 °C...60 °C	

Parameters	SH8.0RT	SH10RT
Allowable relative humidity range (non-condensing)	0...100 %	
Cooling method	Natural convection	
Max. operating altitude	4000 m (> 3000 m derating)	
Noise (Typical)	30 dB(A)	
Display	LED	
Communication	RS485, WLAN, Ethernet, CAN, 4 × DI, 1 × DO	
DC connection type	MC4 (PV) / Sunclix (Battery)	
AC connection type	Plug and play connector	
Compliance	IEC / EN 62109-1, IEC / EN 62109-2, IEC / EN 61000-6-1, IEC / EN 61000-6-3, IEC / EN 61000-3, EN 62477-1, VDE-AR-N-4105, AS/NZS 4777.2	
<b>Mechanical Data</b>		
Dimensions (W x H x D)	460 mm x 540 mm x 170 mm	
Mounting method	Wall-mounting bracket	
Weight	27 kg	
<b>Backup Data</b>		
Nominal voltage	3 / N / PE, 220 Vac / 230 Vac / 240 Vac	
Frequency range	50 Hz / 60 Hz	
Total harmonic factor output voltage	2%	
Switch time to emergency mode	< 20 ms	
Nominal output power	8000 W / 8000 VA	10000 W / 10000 VA
Peak output power	12000 W / 12000 VA, 5min	

\* Depending on the connected battery

## 11.2 Quality Assurance

When product faults occur during the warranty period, SUNGROW will provide free service or replace the product with a new one.

### Evidence

During the warranty period, the customer shall provide the product purchase invoice and date. In addition, the trademark on the product shall be undamaged and legible. Otherwise, SUNGROW has the right to refuse to honor the quality guarantee.

### Conditions

- After replacement, unqualified products shall be processed by SUNGROW.

- The customer shall give SUNGROW a reasonable period to repair the faulty device.

### Exclusion of Liability

In the following circumstances, SUNGROW has the right to refuse to honor the quality guarantee:

- The free warranty period for the whole machine/components has expired.
- The device is damaged during transport.
- The device is incorrectly installed, refitted, or used.
- The device operates in harsh environment, as described in this manual.
- The fault or damage is caused by installation, repairs, modification, or disassembly performed by a service provider or personnel not from SUNGROW.
- The fault or damage is caused by the use of non-standard or non-SUNGROW components or software.
- The installation and use range are beyond stipulations of relevant international standards.
- The damage is caused by unexpected natural factors.

For faulty products in any of above cases, if the customer requests maintenance, paid maintenance service may be provided based on the judgment of SUNGROW.

## 11.3 Contact Information

Should you have any question about this product, please contact us.

We need the following information to provide you the best assistance:

- Type of the device
- Serial number of the device
- Fault code/name
- Brief description of the problem

### China (HQ)

Sungrow Power Supply Co., Ltd

Hefei

+86 551 65327834

[service@sungrowpower.com](mailto:service@sungrowpower.com)

### Australia

Sungrow Australia Group Pty. Ltd.

Sydney

+61 2 9922 1522

[service@sungrowpower.com.au](mailto:service@sungrowpower.com.au)

### Brazil

Sungrow Do Brasil

Sao Paulo

+55 11 2366 1957

[latam.service@sa.sungrowpower.com](mailto:latam.service@sa.sungrowpower.com)

### France

Sungrow France

Lyon

+33420102107

[service@sungrow-emea.com](mailto:service@sungrow-emea.com)

<p><b>Germany, Austria, Switzerland</b></p> <p>Sungrow Deutschland GmbH Munich +49 0800 4327 9289 <a href="mailto:service@sungrow-emea.com">service@sungrow-emea.com</a></p>	<p><b>Greece</b></p> <p>Service Partner – Survey Digital +30 2106044212 <a href="mailto:service@sungrow-emea.com">service@sungrow-emea.com</a></p>
<p><b>India</b></p> <p>Sungrow (India) Private Limited Gurgaon +91 080 41201350 <a href="mailto:service@in.sungrowpower.com">service@in.sungrowpower.com</a></p>	<p><b>Italy</b></p> <p>Sungrow Italy Verona +39 0800 974739 (Residential) /+39 045 4752117 (Others) <a href="mailto:service@sungrow-emea.com">service@sungrow-emea.com</a></p>
<p><b>Japan</b></p> <p>Sungrow Japan K.K. Tokyo + 81 3 6262 9917 <a href="mailto:service@jp.sungrowpower.com">service@jp.sungrowpower.com</a></p>	<p><b>Korea</b></p> <p>Sungrow Power Korea Limited Seoul +82 70 7719 1889 <a href="mailto:service@kr.sungrowpower.com">service@kr.sungrowpower.com</a></p>
<p><b>Malaysia</b></p> <p>Sungrow SEA Selangor Darul Ehsan +60 19 897 3360 <a href="mailto:service@my.sungrowpower.com">service@my.sungrowpower.com</a></p>	<p><b>Philippines</b></p> <p>Sungrow Power Supply Co., Ltd Mandaluyong City +63 9173022769 <a href="mailto:service@ph.sungrowpower.com">service@ph.sungrowpower.com</a></p>
<p><b>Thailand</b></p> <p>Sungrow Thailand Co., Ltd. Bangkok +66 891246053 <a href="mailto:service@th.sungrowpower.com">service@th.sungrowpower.com</a></p>	<p><b>Spain</b></p> <p>Sungrow Ib é rica S.A.U. Mutilva +34 948 05 22 04 <a href="mailto:service@sungrow-emea.com">service@sungrow-emea.com</a></p>
<p><b>Romania</b></p> <p>Service Partner - Elerex +40 241762250 <a href="mailto:service@sungrow-emea.com">service@sungrow-emea.com</a></p>	<p><b>Turkey</b></p> <p>Sungrow Deutschland GmbH Turkey Istanbul +90 216 663 61 80 <a href="mailto:service@sungrow-emea.com">service@sungrow-emea.com</a></p>
<p><b>UK</b></p> <p>Sungrow Power UK Ltd. Milton Keynes +44 (0) 01908 414127 <a href="mailto:service@sungrow-emea.com">service@sungrow-emea.com</a></p>	<p><b>U.S.A, Mexico</b></p> <p>Sungrow USA Corporation Phoenix +1 833 747 6937 <a href="mailto:techsupport@sungrow-na.com">techsupport@sungrow-na.com</a></p>

---

**Vietnam**

Sungrow Vietnam

Hanoi

+84 918 402 140

[service@vn.sungrowpower.com](mailto:service@vn.sungrowpower.com)**Belgium, Netherlands and  
Luxembourg (Benelus)**

Service (only NL): +31 08000227012

[service@sungrow-emea.com](mailto:service@sungrow-emea.com)

---

**Poland**

+48 221530484

[service@sungrow-emea.com](mailto:service@sungrow-emea.com)