

## Assembly instructions

# Hanger Bolt CR



# Content

▶ Tools overview	3
▶ General safety information	4
▶ Required Materials	6
▶ Assembly	8
▶ Notes	14

## Quality tested – several certifications

K2 Systems stands for secure connections, highest quality and precision. Our customers and business partners have known that for a long time. Independent institutes have tested, confirmed and certified our capabilities and components.

Please find our quality and product certificates under:

[www.k2-systems.com/en/technical-information](http://www.k2-systems.com/en/technical-information)



# Tools overview



7mm



9mm

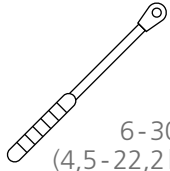

6-30Nm  
(4,5-22,2lb-ft)



6mm



15mm

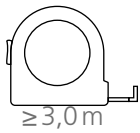

≥3,0m



≥6,0m

# General safety information

Please note that our general mounting instructions must be followed at all times and can be viewed online at [www.k2-systems.com/en/technical-information](http://www.k2-systems.com/en/technical-information).

- ▶ The equipment may only be installed and operated by qualified and adequately trained installers.
- ▶ Prior to installation, ensure that the product complies with on-site static loading requirements. For roof-mounted systems, the roof load-bearing capacity must always be checked.
- ▶ National and local building regulations and environmental requirements must be adhered to.
- ▶ Compliance with health and safety regulations, accident prevention guidelines and applicable standards is required.
  - Protective equipment such as safety helmet, boots and gloves must be worn.
  - Roofing works must be in accordance with roofing regulations utilising fall protection safeguards when eaves height exceeds 3 m.
  - At least two people must be present for the duration of the installation work in order to provide rapid assistance in the event of an emergency.
- ▶ K2 mounting systems are continuously developed and improved and the installation process may thereby change at any time. Prior to installation consult our website at [www.k2-systems.com/en/technical-information](http://www.k2-systems.com/en/technical-information) for up-to-date instructions. We can send you the latest version on request.
- ▶ The assembly instructions of the module manufacturer must be adhered to.
- ▶ Equipotential bonding/grounding/earthing between individual parts is to be performed according to country specific standards, as well as national laws and regulations.
- ▶ At least one copy of the assembly instructions should be available on site throughout the duration of the installation.
- ▶ Failure to adhere to our general safety and assembly instructions and not using all system components, K2 is not liable for any resulting defects or damages. We do not accept liability for any damage resulting in the use of competitor's parts. Warranty is excluded in such cases.
- ▶ German law shall apply excluding the UN Convention on CISG. Place of venue is Stuttgart. Our General Terms of Business apply.
- ▶ If all safety instructions are adhered to and the system is correctly installed, there is a product warranty entitlement of 12 years! We strongly recommend reviewing our terms of guarantee, which can be viewed at [www.k2-systems.com/en/technical-information](http://www.k2-systems.com/en/technical-information) We will also send this information on request.
- ▶ Dismantling of the system is performed in reverse order to the assembly.
- ▶ K2 stainless steel components are available in different corrosion resistance classes. Each structure or component must be carefully checked for possible corrosion exposure.

# The following guidelines apply

The HangerBolt CR SingleRail system can be used without further testing by K2 systems in the following standard conditions. To calculate maximum distances between supports we recommend using our calculation tool K2Base. The system is also suitable for higher requirements. However, if a value exceeds the standard conditions, please contact K2 Systems.



## Roof requirements

- Roof pitch of 5-75°



## Structural requirements

- The static verification of components is automatically calculated for each location using our Base On planning software
- The sufficient holding force of the roof covering at the support or substructure must be ensured on site.



## Important mounting instructions

- We recommend a thermal separation after maximum of 17.60m.
- Do not use Middle and End Clamp set at rail joints. Distance to rail joint min. 20mm.
- Minimum spacing of 50mm from module edge to rail end.
- Tightening torque of all module clamps 14Nm
- For manufacturer information regarding clamps see the manufacturing module data sheet.
- A module row spacing according to planning specification K2 System must be observed.
- The earthing must be provided by the customer and must be carried out according to the respective country-specific regulations.
- On-site general standards and regulations for lightning protection must be observed and consultation with a specialist to create a lightning protection concept is recommended (use lightning protection clamp if necessary).
- Please note the specified screw-in depth of the solar fasteners for wood substructure. You can find this in our Base Report under the heading Results. Only if the specified screw-in depth of the solar fasteners is adhered to can the corresponding values of the load-bearing capacity be fulfilled.

# Essential: The materials required

All system components listed in the following are essential for assembling the K2 Systems SingleRail system. The piece quantities are calculated on the basis of the respective requirements. The listed item numbers facilitate the comparison of items.



**Pre-assembled Hanger Bolt CR**  
Material: Stainless steel, Aluminium, EPDM

| Article number  
system-specific

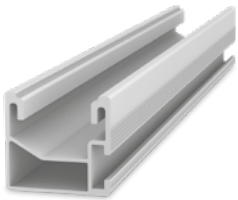

**MountingRail K2 SingleRail**  
Material: Aluminium EN AW-6063 T66

| Article number  
system-specific

Alternative: MountingRail K2 SingleRail 50

| Article number  
system-specific

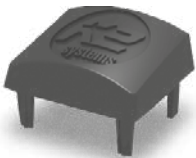

**K2 EndCap SingleRail 36**  
Material: glass fibre reinforced polyamid

| 1004767



**K2 SingleRail 36 Connector Set**

| Article number  
system-specific

The set consists of:

- ▶ 1 SingleRail Connector, Aluminium EN AW-6063 T66
- ▶ 4 T-Bolt M8x20 (1002387), Stainless steel A2
- ▶ 4 Hexagon flange nut with serration M8 (1000043), Stainless steel A2

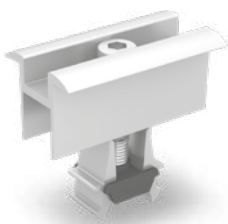

**K2 Universal-Module middle clamp OneMid**

| 2002515

Module frame height: 32-42 mm

Alternative: K2 Module middle clamp XS Set

| Article number  
system-specific

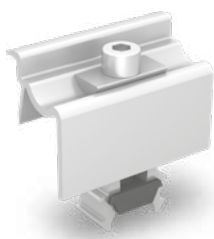

## K2 Universal-Module end clamp OneEnd

Module frame height: 32-42 mm

| 2002514

Alternative: K2 Module end clamp Set

| Article number system-specific

## Additional material for Hanger Bolt L-Adapter



### K2 T-Bolt M8x20

Material: Stainless steel A2  
Head: 20/12

| 1002387

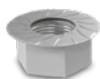

### Nut with serration flange M8

Material: Stainless steel A2, SW 13 mm

| 2002744

## Additional material for cross bracing

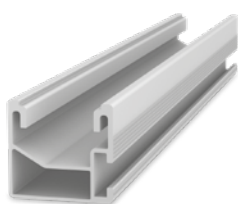

### MountingRail K2 SingleRail

Material: Aluminium EN AW-6063 T66

| Article number system-specific

Alternative: MountingRail K2 SingleRail 50

| Article number system-specific

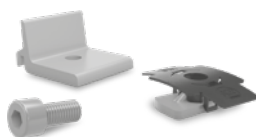

### K2 Climber 36/50 Set

The set consisting of:

- ▶ 1 Climber 36/50 Solo (2003145), aluminium EN AW-6063 T66
- ▶ 1 bolt with serrated under head M8x20, stainless steel A2
- ▶ 1 MK2 insert nut M8 (1001643), stainless steel and PA

| 2003145



### K2 SingleRail Connector Set

The set consisting of:

- ▶ 1 SingleRail connector, aluminium EN AW-6063 T66
- ▶ 4 T-Bolts M8x20 (1002387), stainless steel A2
- ▶ 4 Locking nuts M8 (1000043), stainless steel A2

| Article number system-specific

# Description HangerBolt

The hanger bolt is available in different lengths and diameters. The hanger bolt is suitable for roofs with corrugated fibre cement profiles on timber substructure. Tightness of the roofing is achieved with an FZD sealing element.

Set screw M10 / M12 x Lg A2  
with hexagonal drive

Self-locking nut similar ISO 4161

Climber for HangerBolt,  
Aluminium

Adapter plate, A2

Self-locking nut similar ISO 4161

Thread M10/M12

Self-locking nut similar ISO 4161

Washer

FZD sealing washer

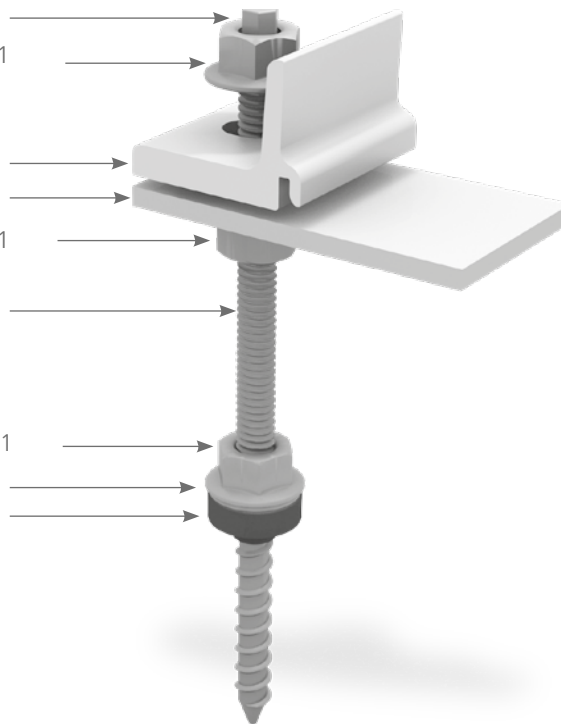



## 1 Pre-drilled hole fibre cement profile on wood substrate

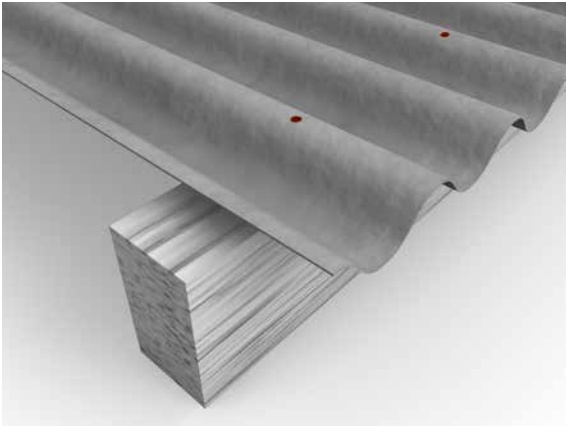

Measure the screw distances according to statics or K2 Base. Check position of purlins and pre-drill through the fibre cement profiles into the purlins.

Fibre cement profiles:  
The pre-drilled hole diameter in the fibre cement profiles must always be greater than the diameter of the Hanger Bolt.

### Table for drilling diameters

Material substructure	Pre-drilled hole fibre cement profiles	Pre-drilled hole wood substrate
Hangerbolt $\varnothing$ 10 mm	14 mm	7 mm
Hangerbolt $\varnothing$ 12 mm	15 mm	8,5 mm

## 2 Hanger bolt screw in

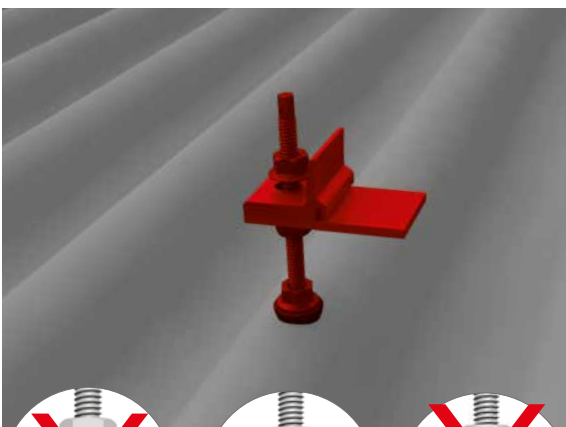

Before mounting the solar fasteners, remove any burr from the surface of the profile sheets. Insert the Hangerbolt into the pre-drilled hole and screw in.

Additional information: Do not tighten the Hangerbolt with the torque, the seal must be slightly compressed and rest on the entire surface.

Materials required: Hangerbolt

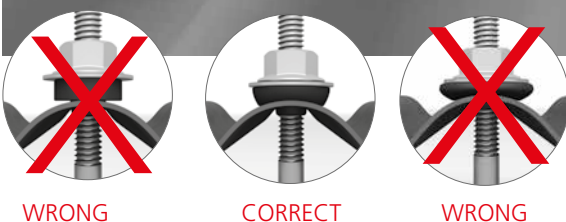

WRONG

CORRECT

WRONG

### 3 Adjust adapter plant with Climber / L-Adapter

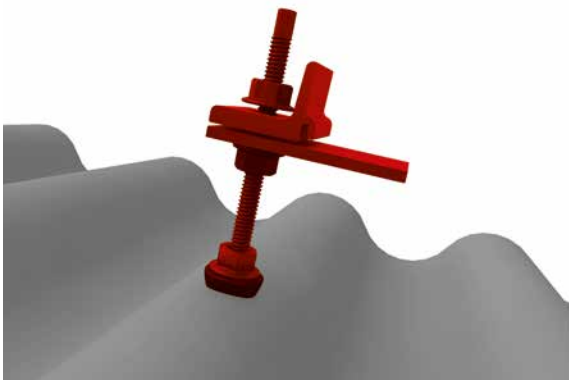

Screw the locking nut under the adapter plate /L-adapter into the correct position to define the height of the adapter plate /L-adapter.

After correct adjustment of the L-adapter, fasten the upper locking nut.

In the case of the HangerBolt with climber, the upper nut is only fixed tightly after the profile has been inserted.

### 4 Mounting rails and rail connectors

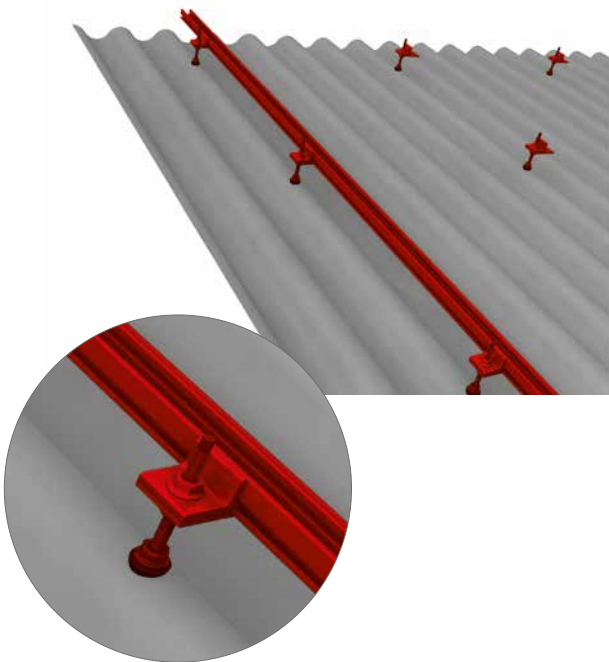

#### Assembly Hangerbolt CR:

The module rail is placed onto the adapter plate and inserted into the Climber with its lateral groove. After the correct adjustment of the rail in the Climber, the upper self-locking nut of the hanger bolt is tightened. Attention must be paid to the correct position of the module rail in all Climbers.

Tightening torque: 32 Nm

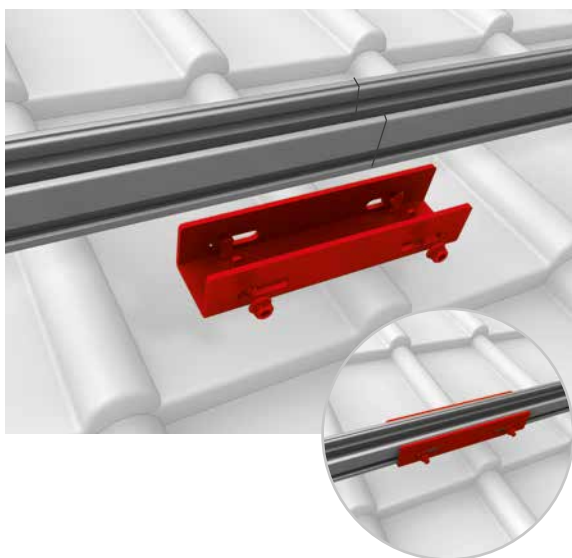

Lay Mounting Rail on joint with rail connector and connect with T bolts and self-locking nuts. The rail joint may not be in the range of the roof fastener. Tightening torque 16 Nm.

## 5 Mounting End Clamps



Fix the module in place at the end of a row with universal module end clamp OneEnd. Click the Stance in the notches. Alternatively use the standard end clamp. Insert the MK2 nut into the mounting rail and turn clockwise by 90°. Place clamps on the module frames and fix them. Never mount module end clamps directly on the rail joint or end of the rail! (Spacing: min. 50 mm from edge of module frame). Pay attention to the mounting instructions by module manufacturer!

Tightening torque 14 Nm.

Materials required: OneEnd

## 6 Attach module gaps



Use two universal module middle clamp OneMid between two modules. Klick the Stance in the notches. Place clamps on the module frames and fix them. Tightening torque 14 Nm.

Materials required: OneMid

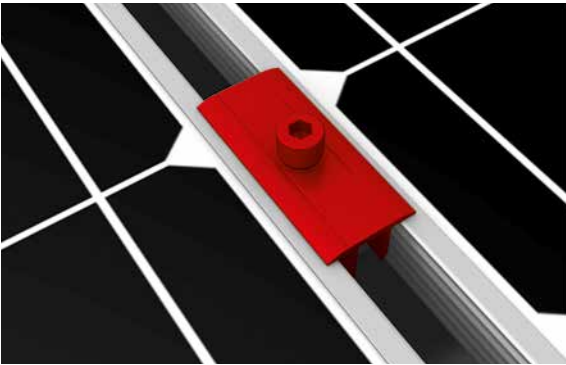

Attaching with XS Middle Clamp

Use two XS Middle Clamps between two modules, which must also be screwed with the DIN 912 M8 screws in the slot nuts.

Tightening torque 14 Nm.

Materials required: Module middle clamp XS Set

## 7 Thermal separation

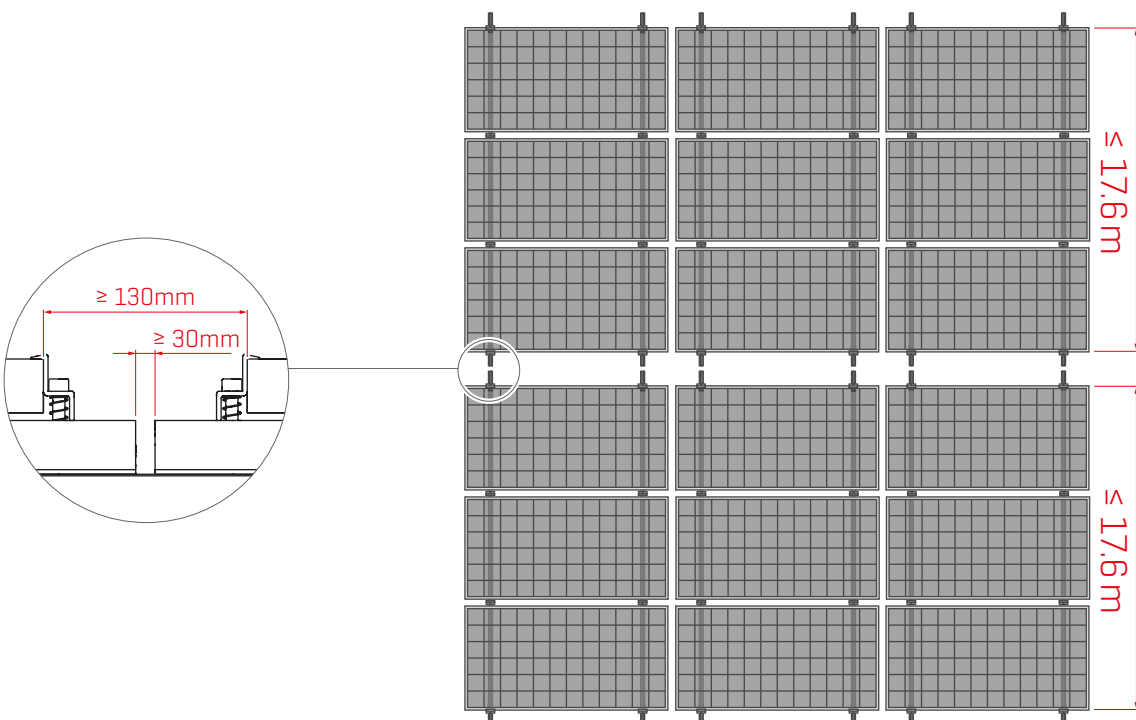

# Assembly

## Alternative system designs (cross bracing) with SingleRail

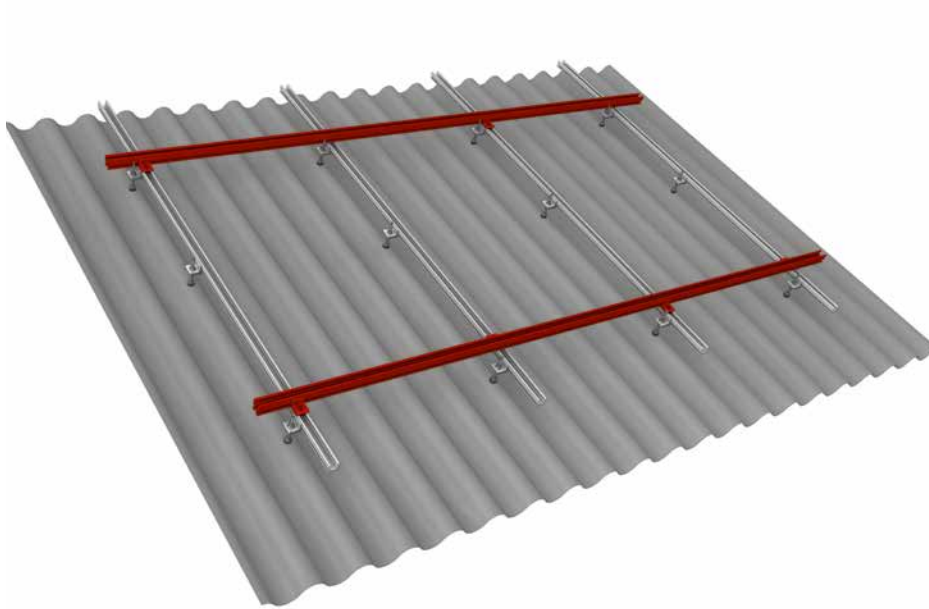

In cross bracing, the upper rail position is fitted using the MK2 slot nut, climber and bolt with serrated under head M8 to the desired location, with appropriate spacing.

Tightening torque 16 Nm.

Mount rail and climber as shown below:

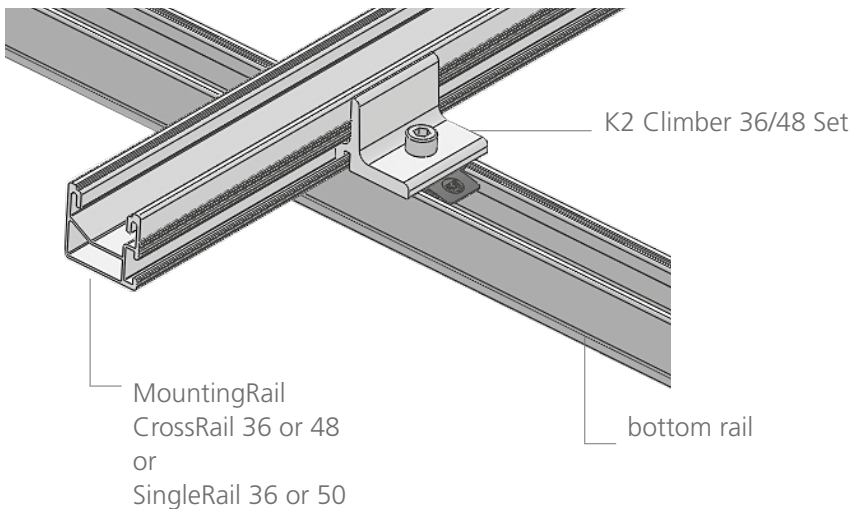

## Mount rail connector



Lay Mounting Rail on joint with rail connector and connect with T bolts and self-locking nuts. The rail joint may not be in the range of the roof fastener.

Tightening torque 16 Nm.

# Note

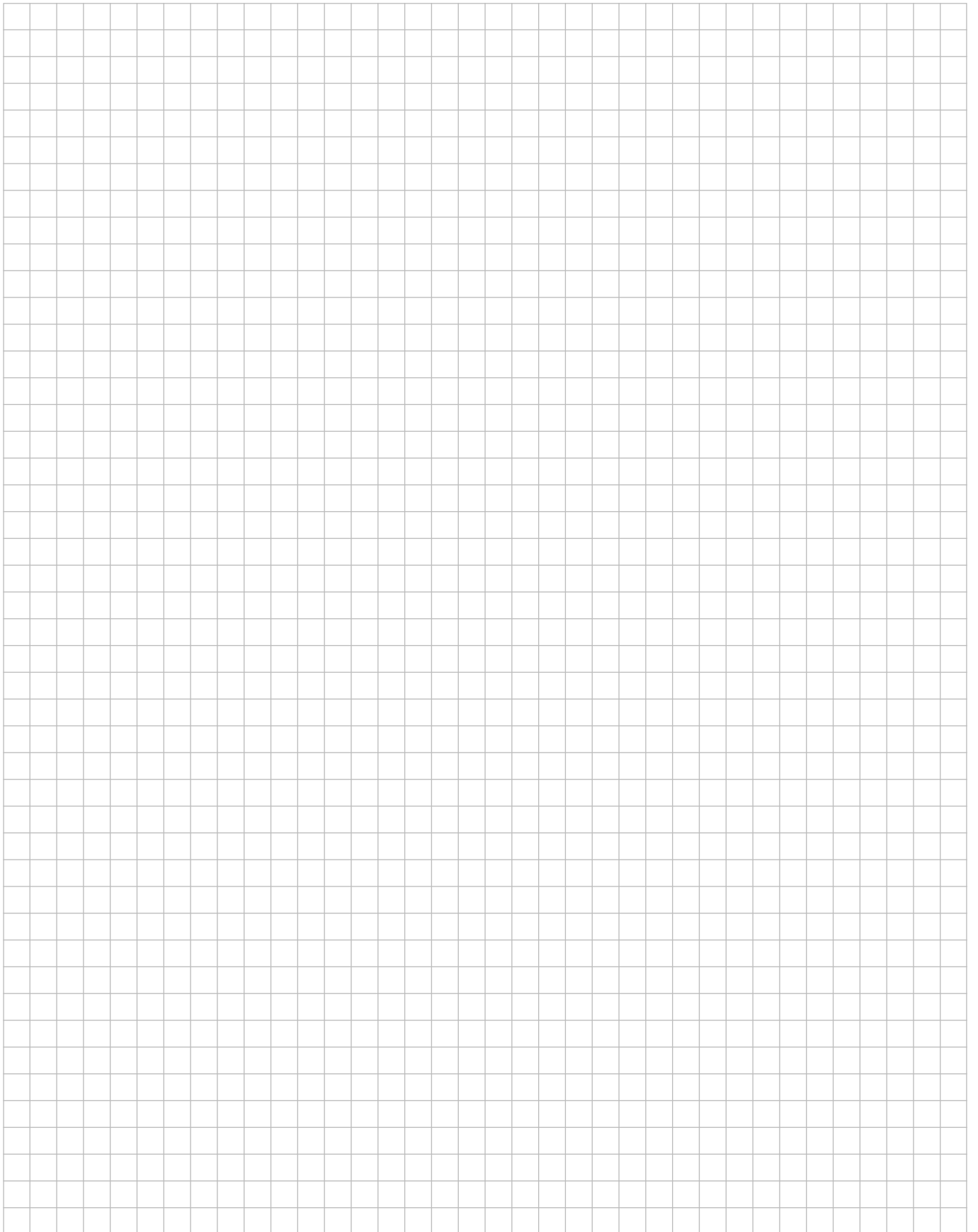

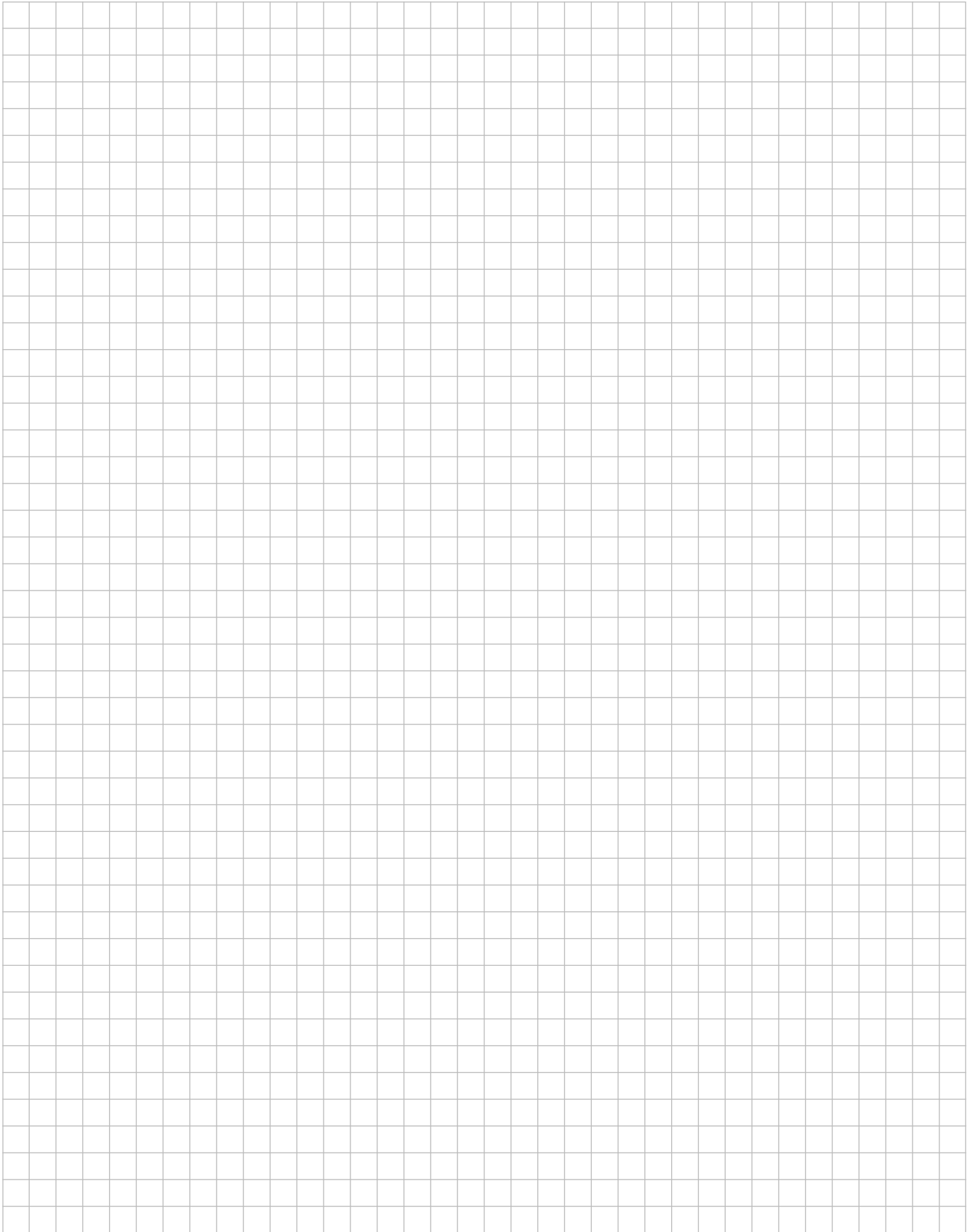

## THANK YOU FOR CHOOSING A K2 MOUNTING SYSTEM.

Systems from K2 Systems are quick and easy to install. We hope these instructions have helped. Please contact us with any questions or suggestions for improvement.

Our contact data:

- ▶ [www.k2-systems.com/en/contact](http://www.k2-systems.com/en/contact)
- ▶ **Service Hotline: +49 (0)7159 42059-0**

Our General Terms of Business apply. Please refer:  
[www.k2-systems.com](http://www.k2-systems.com)

**K2 Systems GmbH**  
Industriestraße 18  
71272 Renningen  
Germany  
Tel. +49 (0) 7159 - 42059 - 0  
[info@k2-systems.com](mailto:info@k2-systems.com)  
[www.k2-systems.com](http://www.k2-systems.com)