



Union Jack



3 Sizes

Thank you for buying this pattern, I really hope you enjoy making it and have fun when choosing your fabrics.

There are several sizes included, and each size includes a ¼" seam allowance when complete.

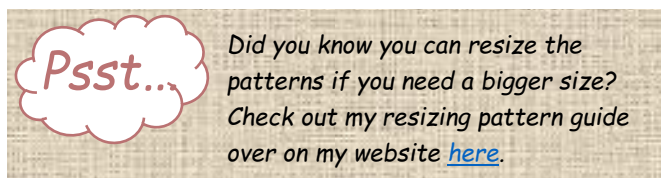

This pattern pack does not include instructions on how to paper piece and assumes that you are already experienced in foundation paper piecing.

If you are new to paper piecing, there are many tutorials on YouTube to help guide you and you can also find a [tutorial](#) with some tips and tricks over on my website. It is such an easy technique once you know the basics.

When printing the pattern, it is important to ensure there is no scaling applied and it is printed at actual size.

A colouring page is included to help plan your design as well as a pattern envelope if you wish to store your pattern or gift it to a friend.

Instructions for making a quilt are not included, layouts are provided as suggestions only.

Pattern# FBDF00006

If you have any queries or encounter any issues with this pattern, please contact me. Don't forget to share your finished blocks on social media, I would love to see your creations.

The boring bit...

This pattern is designed and intended for personal use only and may not be resold, permission is granted to sell the finished item provided the item is handmade by you and you credit Full Bobbin Designs for the design. No mass production is allowed.

Enjoy, and Happy Sewing!

Sarah♥



Contents

Contents	2
Assembling the Pattern Sleeve	3
Joining the Pattern Pieces	4
Pattern Sleeve Template.....	5
Quilt Ideas.....	7
Design Page	8
Assembling the Block	9
8 x 8	10
9 x 9	12
10 x 10	14

Assembling the Pattern Sleeve

1. Cut out the front and back of the sleeve pattern along the grey lines.
2. Fold along the dashed lines towards the back, as shown in the diagram below.

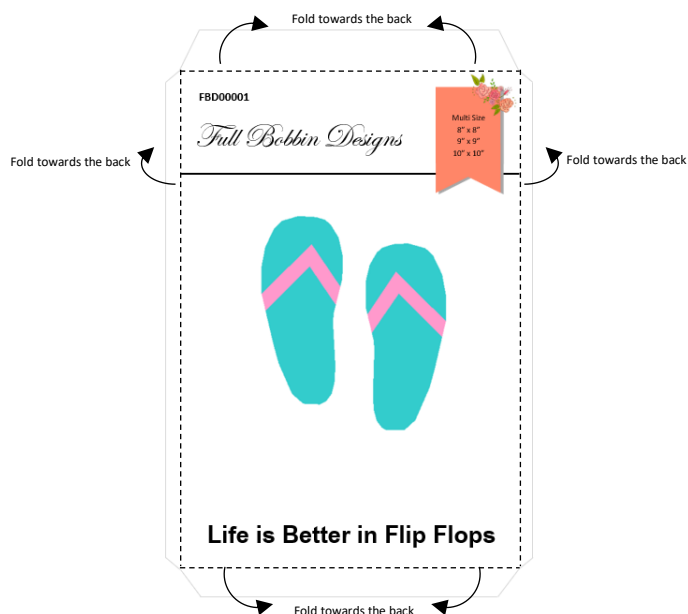

3. With the front of the pattern sleeve facing down add glue only to the bottom and side sections you just folded in the previous step.

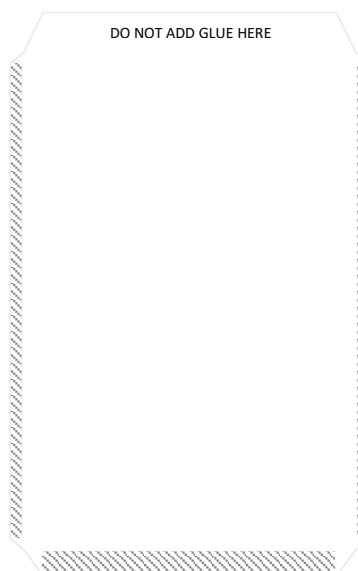

4. Place the back of the sleeve, lining it up to the folded edges and press the glued sections onto the back to secure and your pattern sleeve is complete.

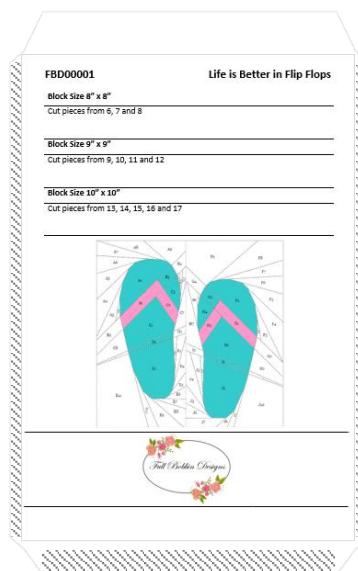

Joining the Pattern Pieces

Some patterns include sections that need to be glued together before stitching as they are too large to be printed onto 1 page.

Each glue edge is numbered in sequence e.g., Glue Edge #1 should be glued to Glue Edge #1 and so on.

Once the sections are cut out you can glue or use tape to attach the sections together as follows:

1. Cut off one of the Glue Edges.

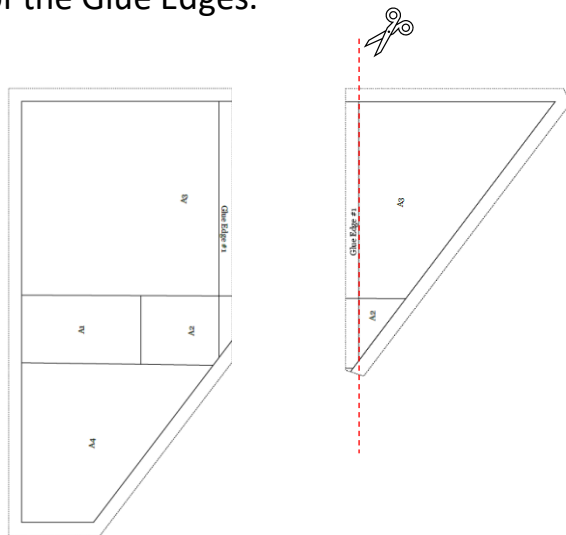

2. Next, overlap the sections so the stitch lines meet and adhere them together.

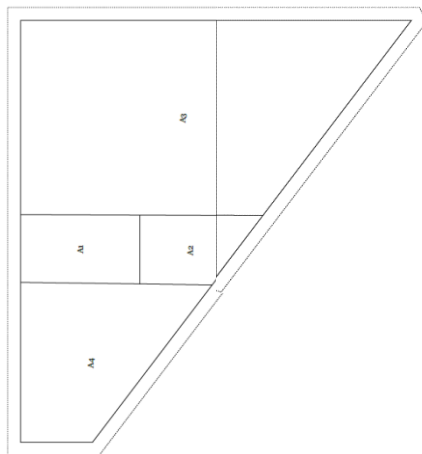

Pattern Sleeve Template

FBDF00006

Full Bobbin Designs



Union Jack

FBDF00006

Union Jack

Block Size 8" x 8"

Cut pieces from pages 10 and 11

Block Size 9" x 9"

Cut pieces from pages 12 and 13

Block Size 10" x 10"

Cut pieces from pages 14, 15 and 16

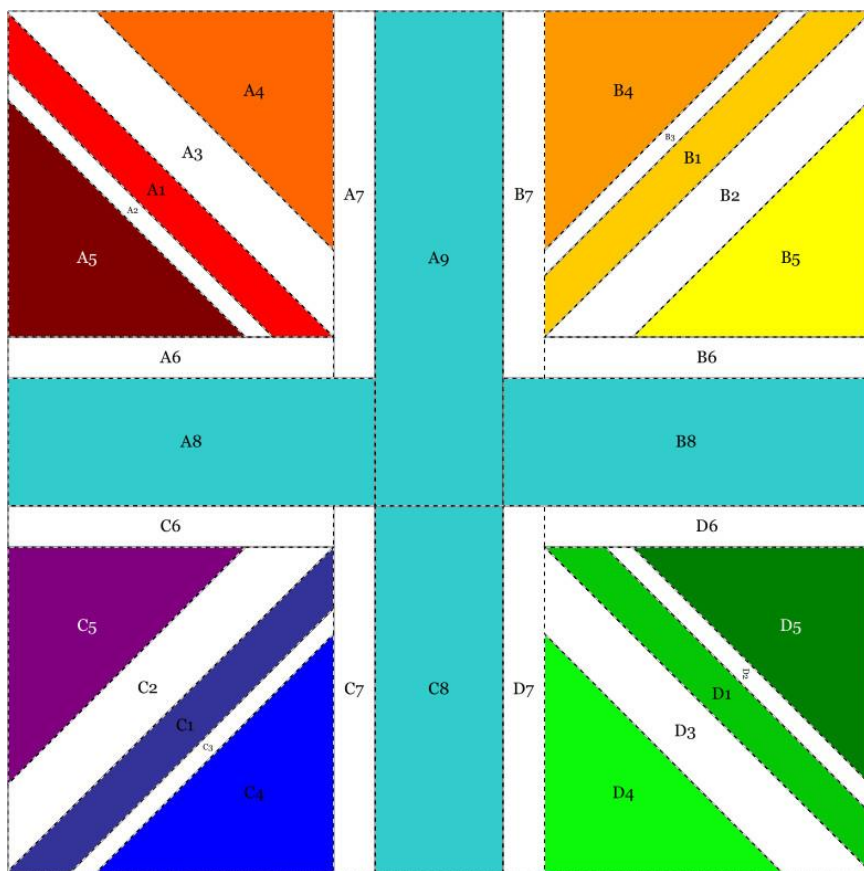

Quilt Ideas



Design Page

Use this page to get creative with colour to help when choosing your fabric (*please note this page is not to scale.*)

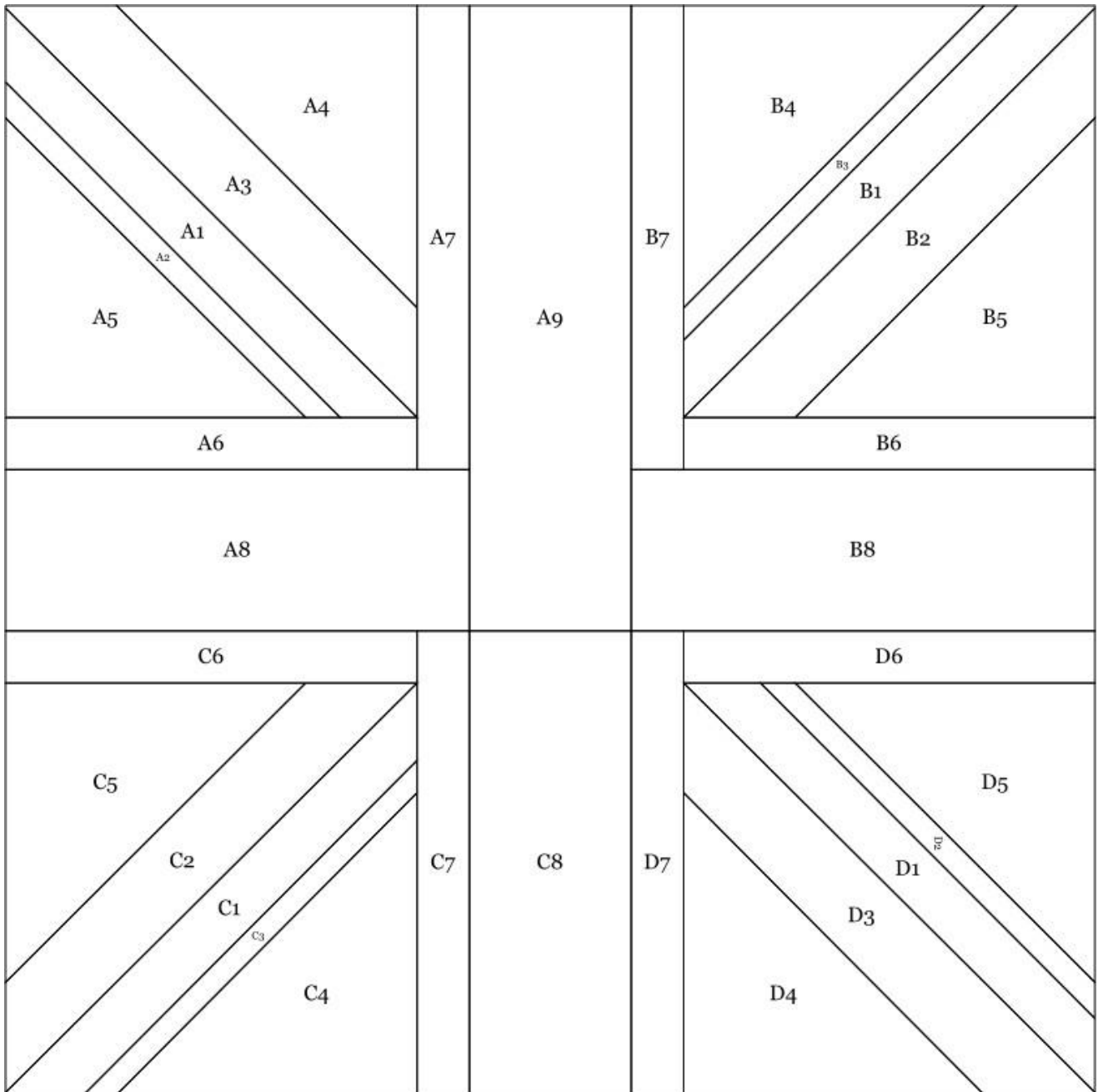

Assembling the Block

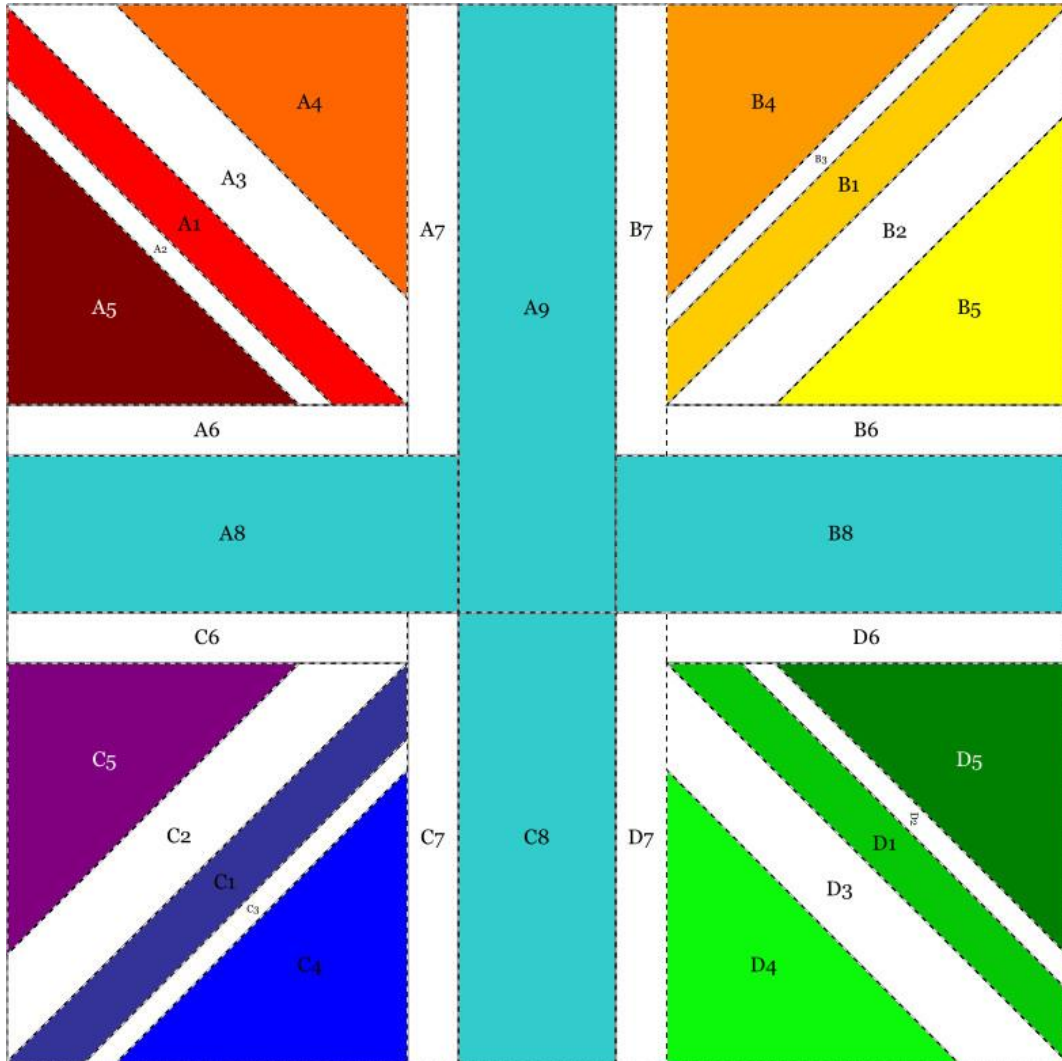

After completing each section join them together as follows:

- A to B
- C to D
- AB to CD

8 × 8

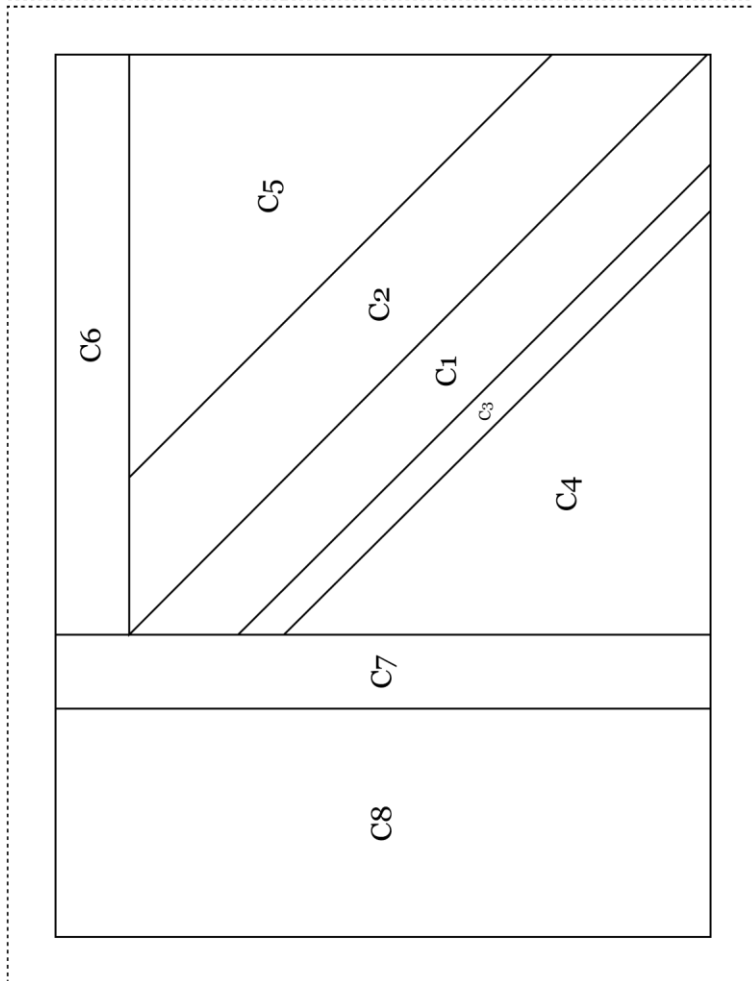
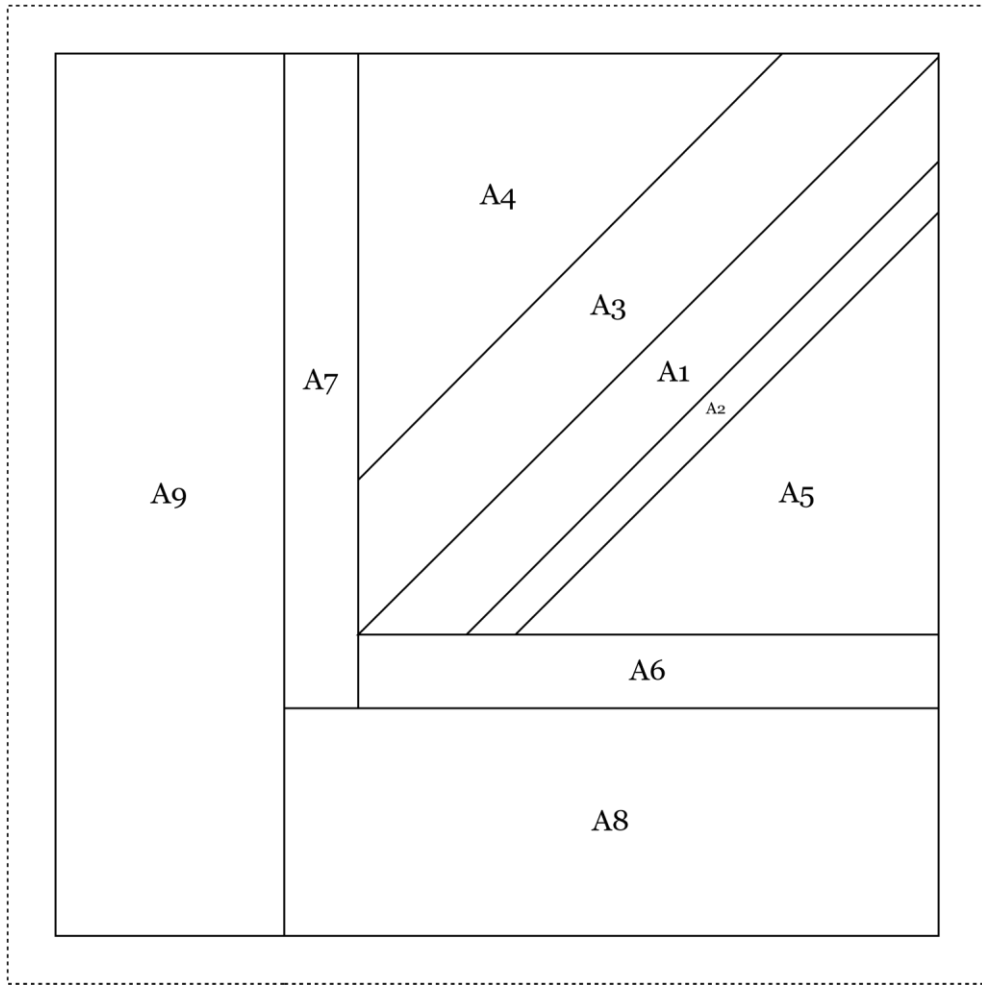

8 × 8

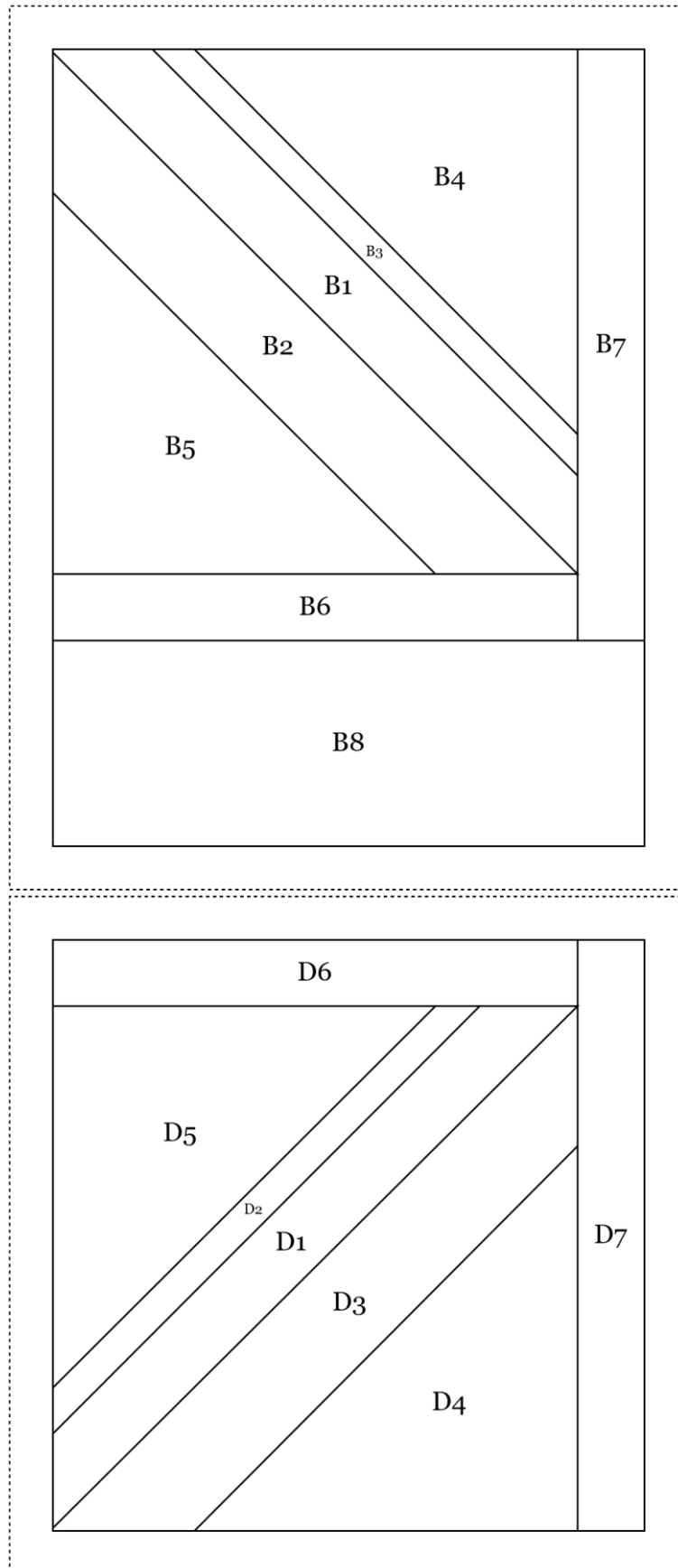

9 x 9

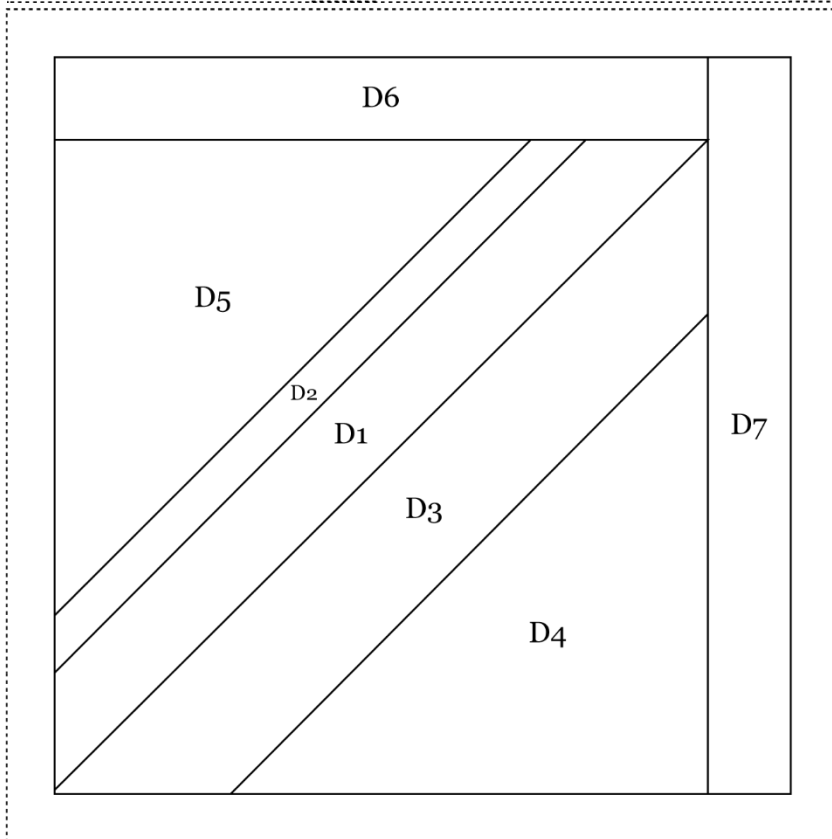
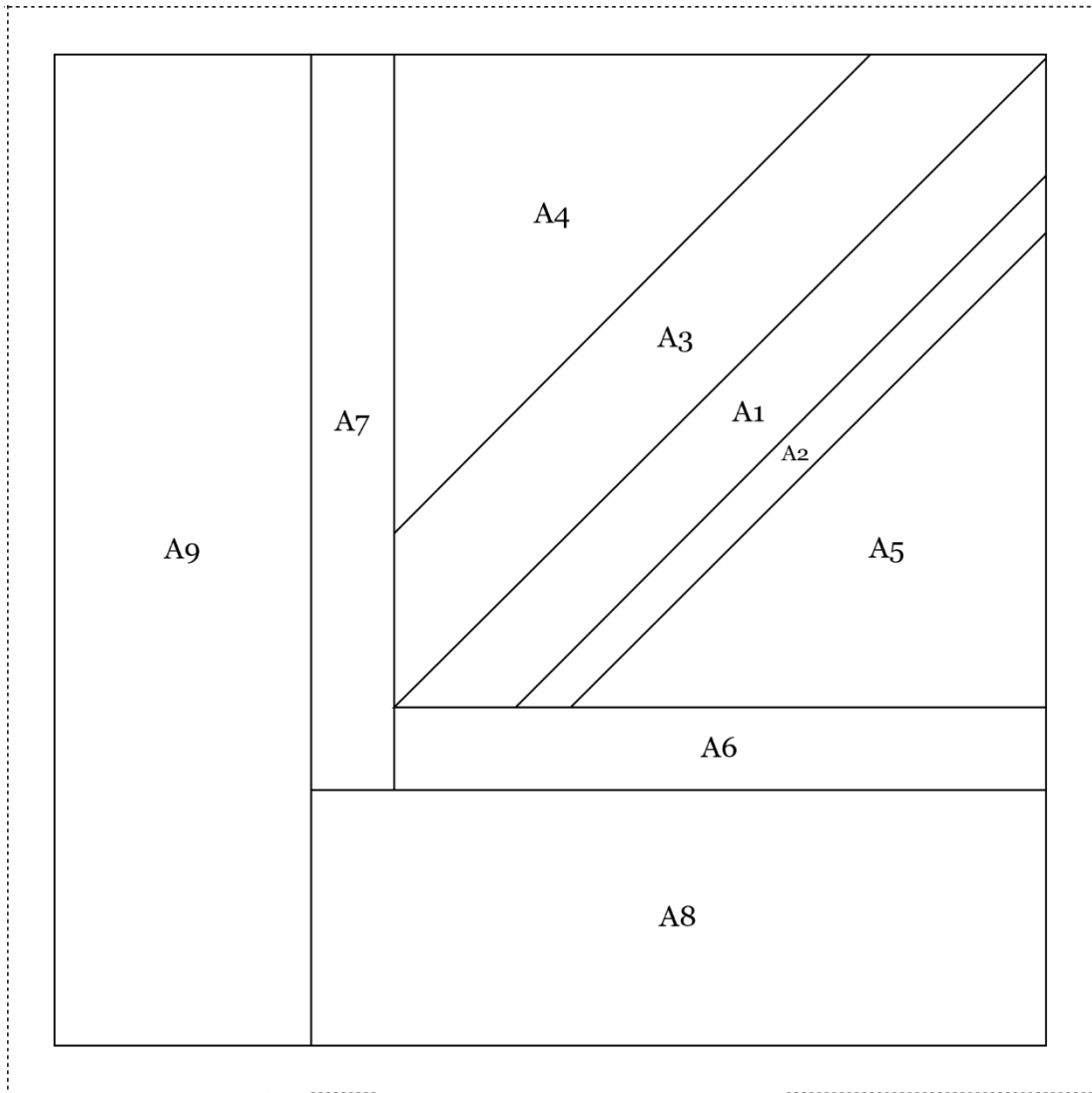

9 x 9

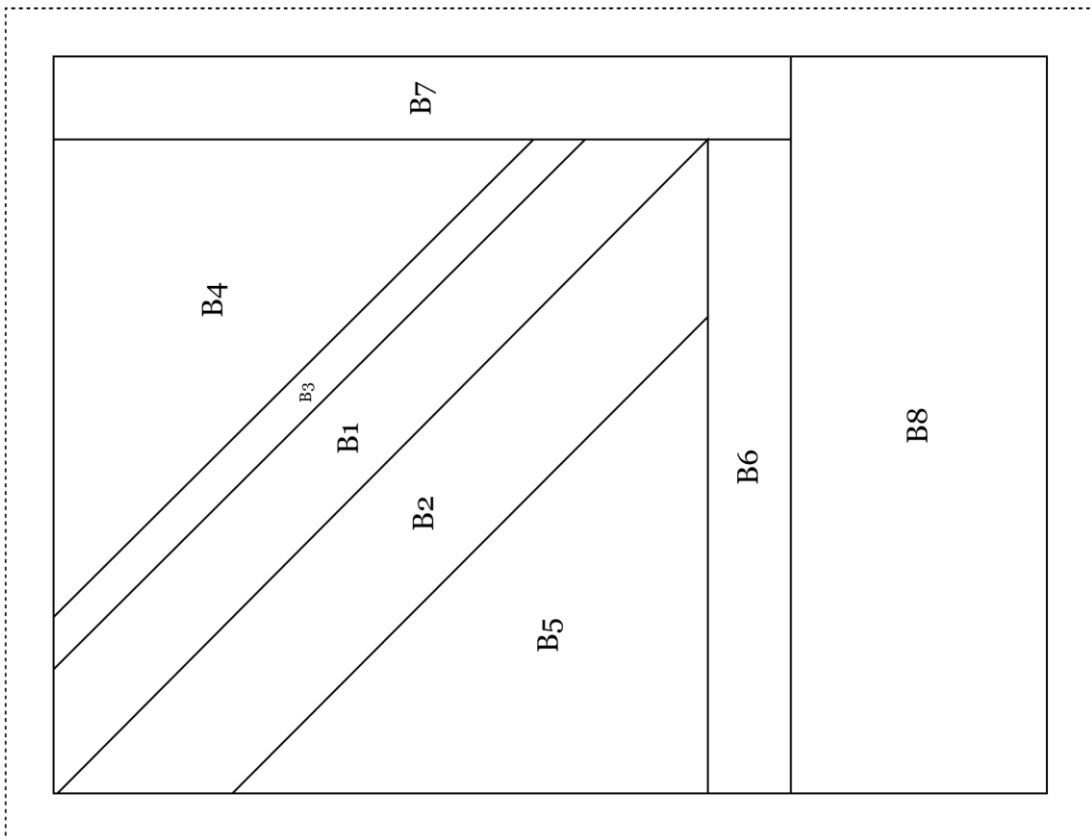
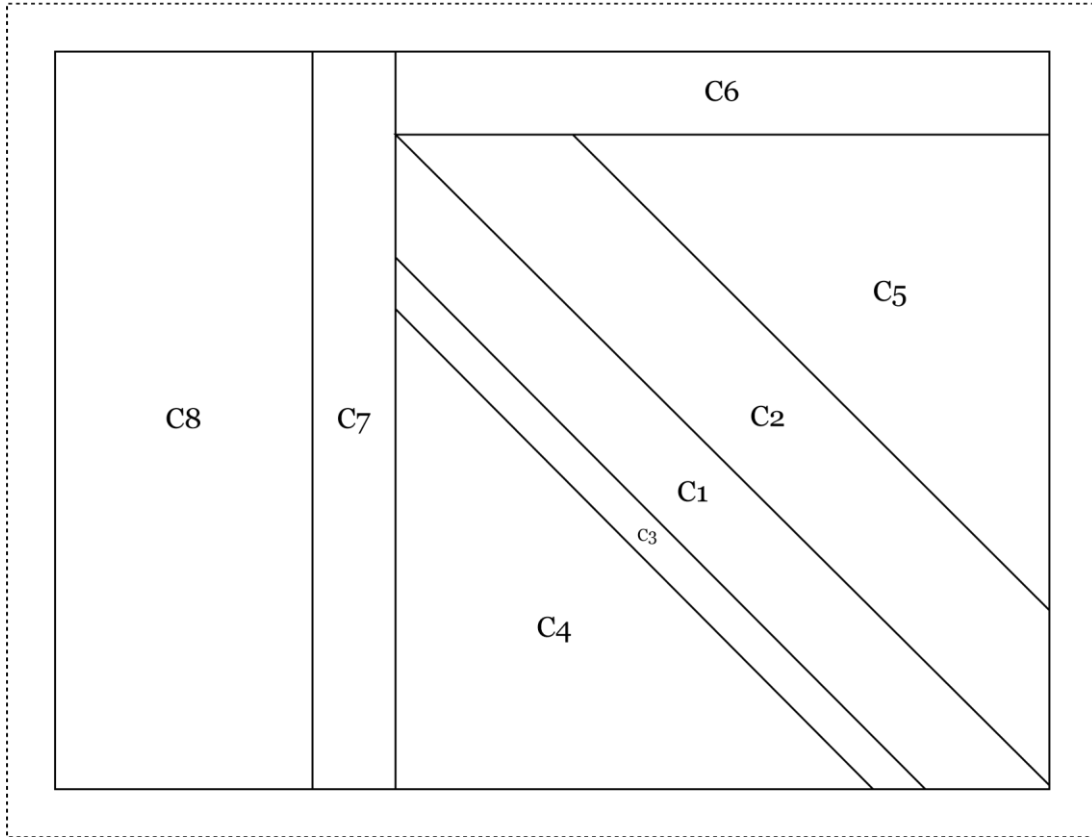

10 x 10

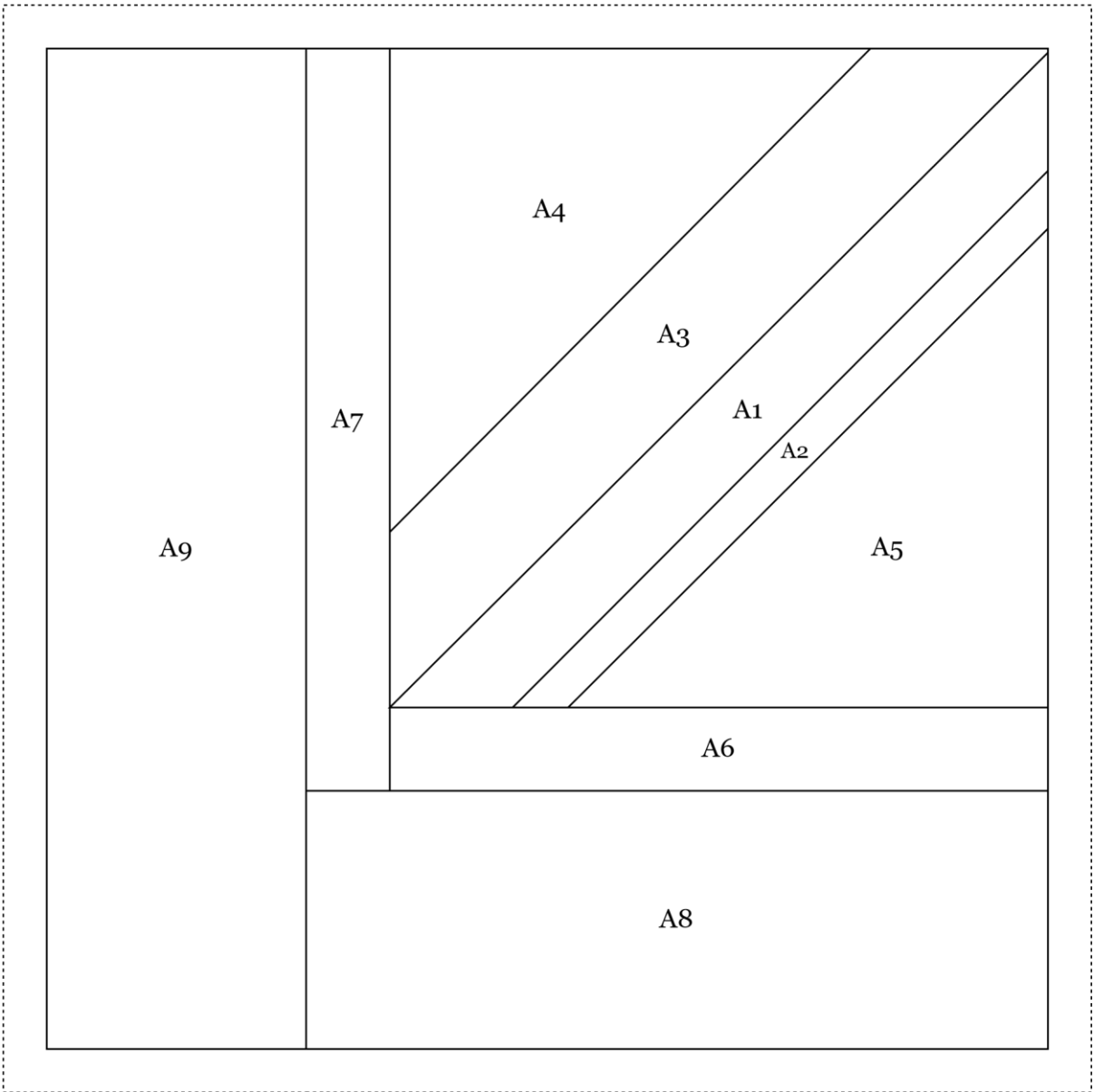

10 x 10

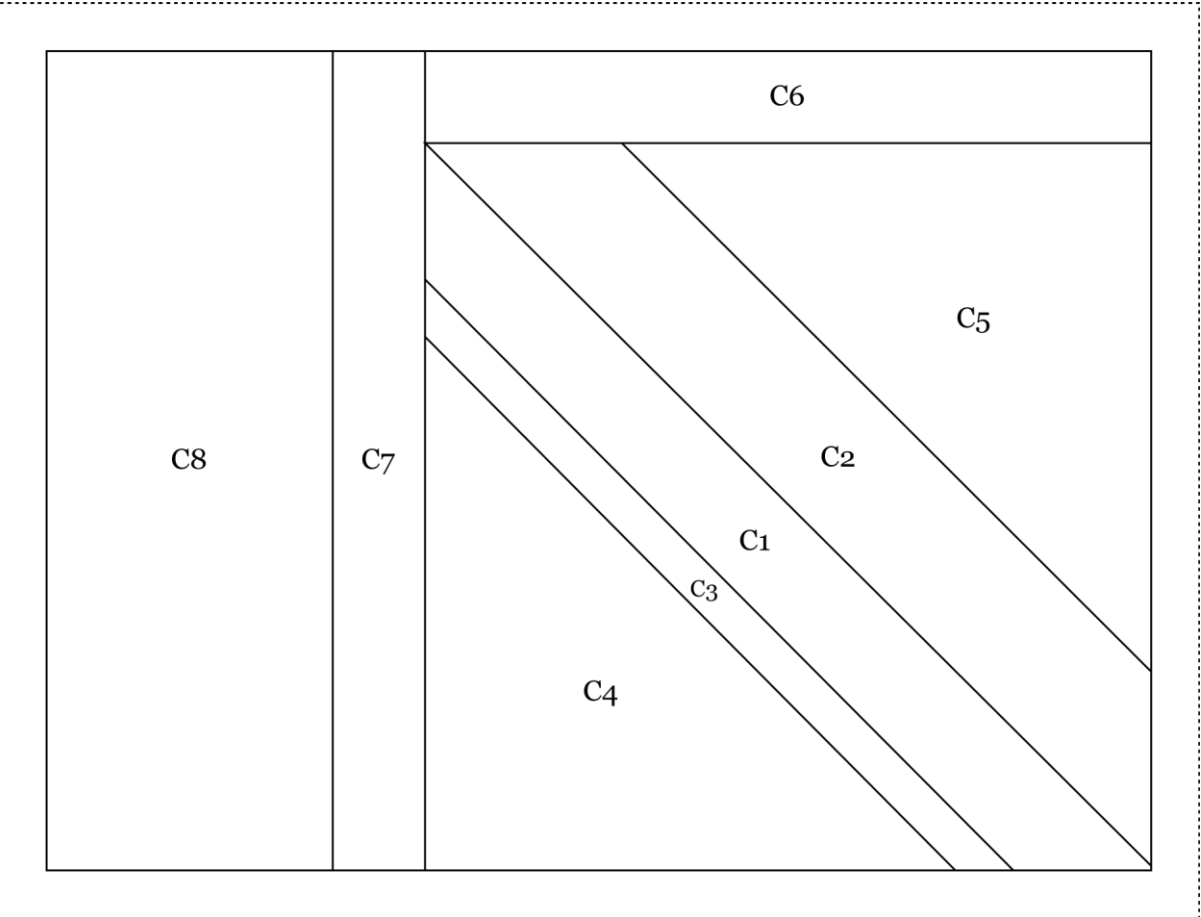
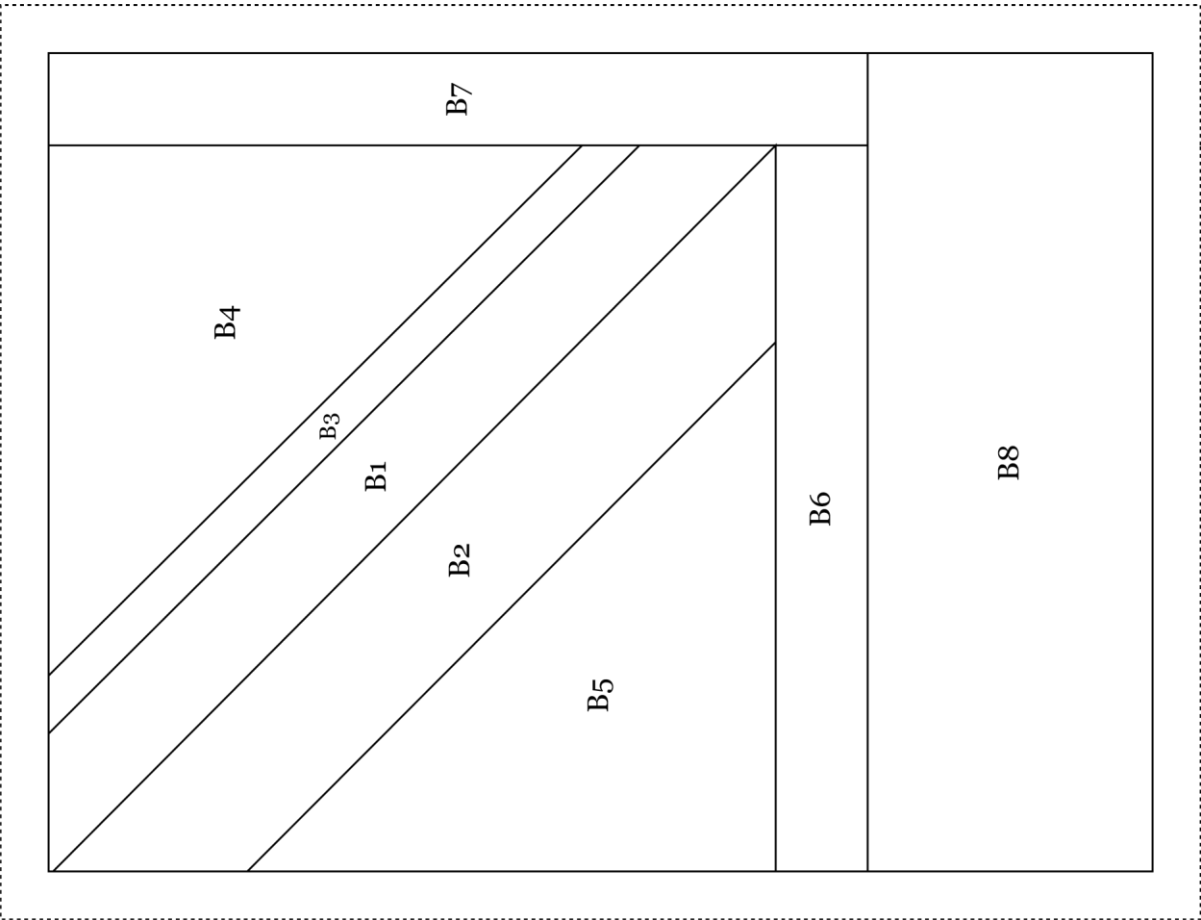

10 × 10

