

UBP4 - Column Protector

Rotationally moulded from polyethylene, this highly visible, maintenance free column protector is an extremely effective way to protect your buildings and goods from forklift truck damage.

NOTE: This product is not designed for use with cast iron columns

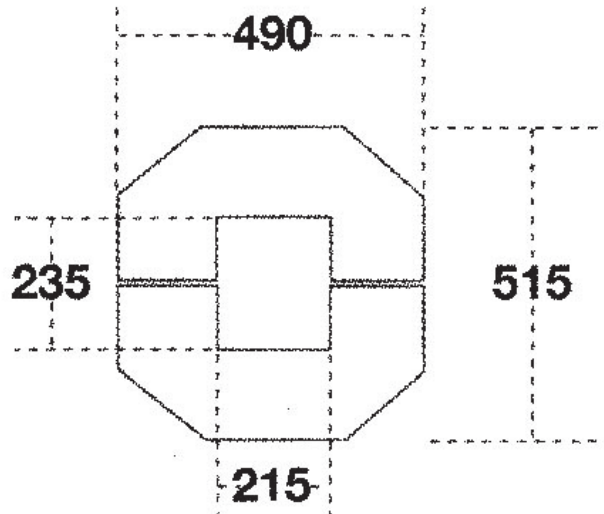

SPECIFICATION

External Size	515mm L x 490mm W x 945mm H - min wall thickness 8mm
Colour	Yellow
Tare Weight	18kg

