

## 4.INSTALLATION NOTES

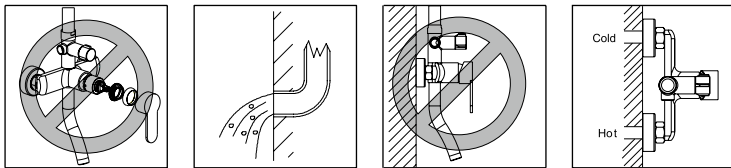

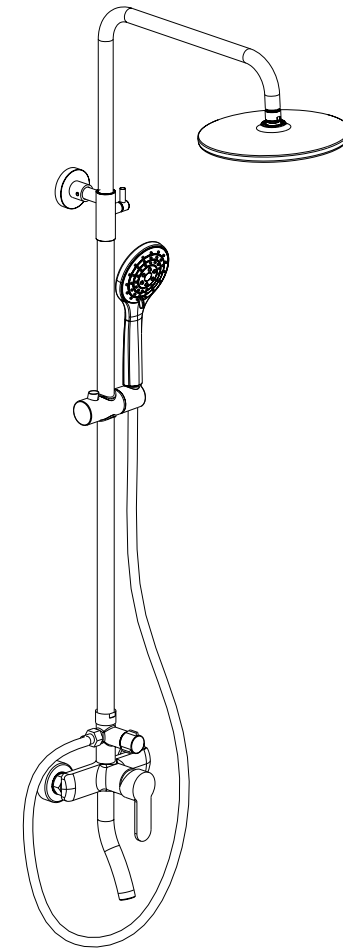









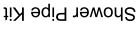

- 1.Refer to the <Standard Part List> when you open package, check all parts available.
- 2.Determine products applicability and functionality in relation to mounting surface.
- 3.Do not disassemble mixer body by yourself.
- 4.Determine position where hot pipe and cold pipe will be fitted, Left for hot water, and Right for cold water supply.
- 5.Determine Inlet pipes and supply stopper have been installed and cleaned, also ensure no impurities In pipeline.
- 6.When finished installation, check all joints and connections for leaks.
- 7.Do not overexposed mixer body in touch with high temperature $\geq 90^{\circ}\text{C}$ , as there is some ABS and EPDM components in mixer.
- 8.Water pressure shall be:  $0.05\text{Mpa}\leq\text{Water Pressure}\leq 0.75\text{Mpa}$ .

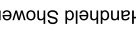

# Instruction Manual



## 1. STANDARD ACCESSORIES LIST

## 2. INSTALLATION SKETCH

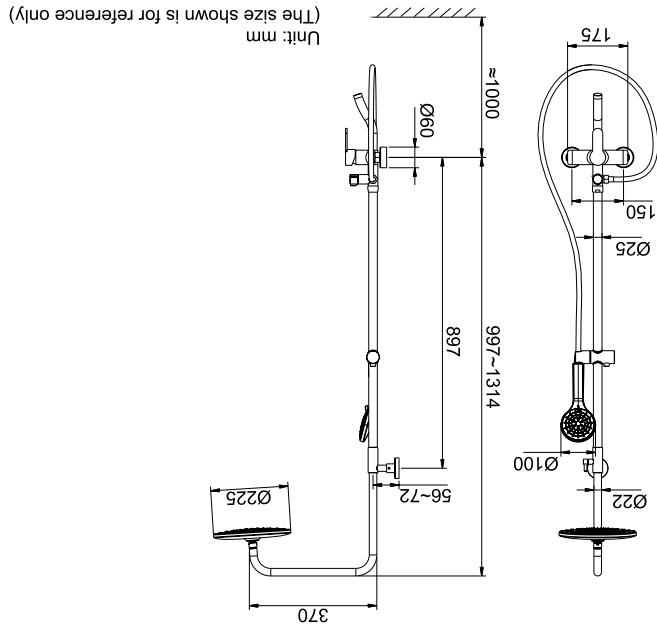

## 3. INSTALLATION STEPS

