

User's Manual

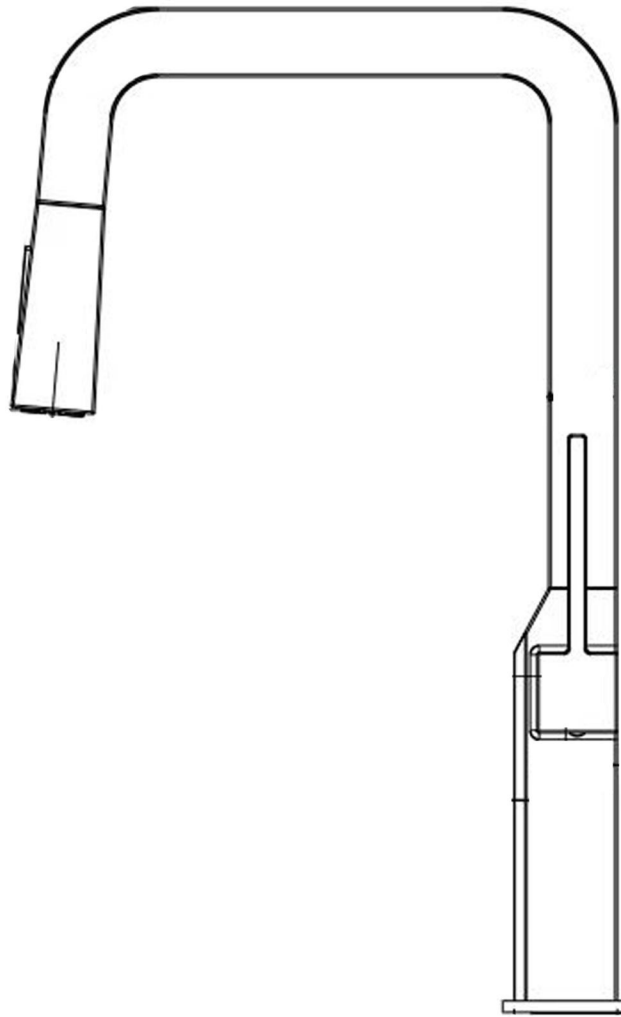

INSTALLATION INSTRUCTIONS

Installation Manual



RB1263

IAPMO RESEARCH AND TESTING, INC.
5001 East Philadelphia Street, Ontario, California 91761-2816 • USA • 909-472-4100 • 909-472-4244 • www.iapmotest.org

CERTIFICATE OF LISTING

 This certificate is not evidence of current listing. To verify listing status, visit the IAPMO R&T Product Listing Directory at pld.iapmo.org

Effective Date: December 2019 -Rev. 2/24/2020- Void After: December 2024
Product: Flexible Water Connectors File No. 5111
Issued To: Fanaki Group Inc., Mechanical & Electrical Industrial Zone, Yuhuan County, Yuhuan 317600, ZHEJIANG, China

Identification: Products shall be marked with manufacturer's name or trademark, a statement "For use with water in accessible locations only." The product shall also bear the cUPC® certification mark. Markings shall be by means of either a permanent mark on the product, a label on the product or a tag attached to the product.

Characteristics: Flexible water connectors manufactured in various sizes, lengths and metal and fittings for hot or cold water applications that consist of an inner tube, which may or may not have an outer braided cover. Connectors are to be installed for use in accessible locations only. To be installed in accordance with the manufacturer's instruction, and the latest edition of the Uniform Plumbing Code and National Plumbing Code of Canada.

Products listed on this certificate have been tested by an IAPMO R&T recognized laboratory. This recognition has been granted based upon the

This listing is based upon the test data of the results indicated on the Effective Date and Void After Date shown above. Any change in material, manufacturing process, marking or design without written prior consent of the Product Certification Committee, or any violation of the applicable code or standard, shall be deemed sufficient cause for revocation of this listing. Production of or reference to this form for advertising purposes may be made only by specific, written permission of IAPMO Research and Testing, Inc. Any alteration of this certificate could be grounds for revocation of this listing. This document shall be reproduced in its entirety.

IAPMO RESEARCH AND TESTING, INC.
5001 East Philadelphia Street, Ontario, California 91761-2816 • USA • 909-472-4100 • 909-472-4244 • www.iapmotest.org

CERTIFICATE OF LISTING

 This certificate is not evidence of current listing. To verify listing status, visit the IAPMO R&T Product Listing Directory at pld.iapmo.org

Effective Date: November 2019 Void After: November 2024
Product: Plumbing Fixture Fittings File No. 10633
Issued To: Aqua Gallery Co., Ltd 13th-15th A10 Block International Dynamics Sanitary City, 528000 Foshan, China

Identification: Plumbing supply fittings complying with this Standard shall be marked with the manufacturer's recognized name, trademark, or other mark or, in the case of private labeling, the name, trademark or other mark of the customer for whom the fitting was manufactured. The marking shall be accomplished by use of a permanent mark or by placing a permanent label on the product. Markings on plumbing supply fittings shall be visible after installation.

Single-handle, single-control, and automatic compensating mixing bath and shower valves shall have identifiable temperature control settings in which the settings are indicated by words ("cold", "warm", "hot", etc.), by numbers, or graphically.

Packages shall be marked with the manufacturer's name, trademark, or other mark as well as the model number or, in the case of private

This listing is based upon the test data of the results indicated on the Effective Date and Void After Date shown above. Any change in material, manufacturing process, marking or design without written prior consent of the Product Certification Committee, or any violation of the applicable code or standard, shall be deemed sufficient cause for revocation of this listing. Production of or reference to this form for advertising purposes may be made only by specific, written permission of IAPMO Research and Testing, Inc. Any alteration of this certificate could be grounds for revocation of this listing. This document shall be reproduced in its entirety.

IAPMO RESEARCH AND TESTING, INC.
5001 East Philadelphia Street, Ontario, California 91761-2816 • USA • 909-472-4100 • 909-472-4244 • www.iapmotest.org

CERTIFICATE OF LISTING

 This certificate is not evidence of current listing. To verify listing status, visit the IAPMO R&T Product Listing Directory at pld.iapmo.org

Effective Date: March 2019 Void After: March 2024
Product: Plumbing Fixture Fittings - Components File No. MC-9703
Issued To: Ningbo Nantai Cartridge Technology Co., Ltd, Linsen Zone, Chunhui Fuyuan, NINGBO 315518, China

Identification: Each fitting component shall bear permanent legible markings to identify the manufacturer. This marking shall be the trade name, trademark, or other mark known to identify the manufacturer. The product shall also bear all other markings required by the standards. The marking shall be applied so as to be visible after installation. The product or packaging shall also bear the cUPC® certification mark along with the term "COMPONENT" above.

Characteristics: Plumbing fixture fitting components to be installed in accordance with the manufacturer's instructions and the requirements of the latest edition of the Uniform Plumbing Code.

Products listed on this certificate have been tested by an IAPMO R&T recognized laboratory. This recognition has been granted based upon the Laboratory's compliance to the applicable requirements of ISO/IEC 17025.

Products are in compliance with the following code(s):
Uniform Plumbing Code (UPC®)

This listing is based upon the test data of the results indicated on the Effective Date and Void After Date shown above. Any change in material, manufacturing process, marking or design without written prior consent of the Product Certification Committee, or any violation of the applicable code or standard, shall be deemed sufficient cause for revocation of this listing. Production of or reference to this form for advertising purposes may be made only by specific, written permission of IAPMO Research and Testing, Inc. Any alteration of this certificate could be grounds for revocation of this listing. This document shall be reproduced in its entirety.

BEFORE INSTALLATION

This product has been inspected and debugged by the factory to the best condition. Please do not disassemble and assemble it yourself.

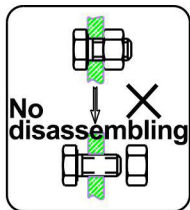

Before installing the product, please be sure to remove sundries and sludge from the water pipe to prevent sundries from blocking the product.



1. Please read the manual firstly before installation;
2. Please check the condition of all the parts, and the installation tools are not included, please prepare it by yourself;
3. User manual includes matters needing attention during installation, please keep it properly;
4. The size chart in the manual is for reference only, please refer to the actual product that you receive.

Recommend Tools :

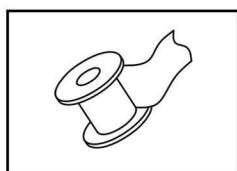

PTFE Tape

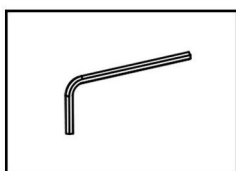

Hex Key

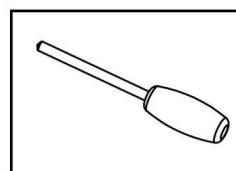

Slotted Screwdriver

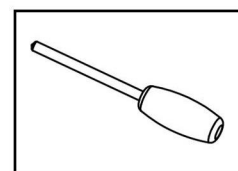

Phillips Screwdriver

1. The sundries at the connection area must be cleared before installation to avoid blockage or leakage;
2. Connect the inlet pipe correctly as shown in the figure;
3. The maximum temperature of hot water is not higher than 80°C (176°F);
4. Please contact seller for consultation if you need to install in other method.

INSTALLATION DIMENSION

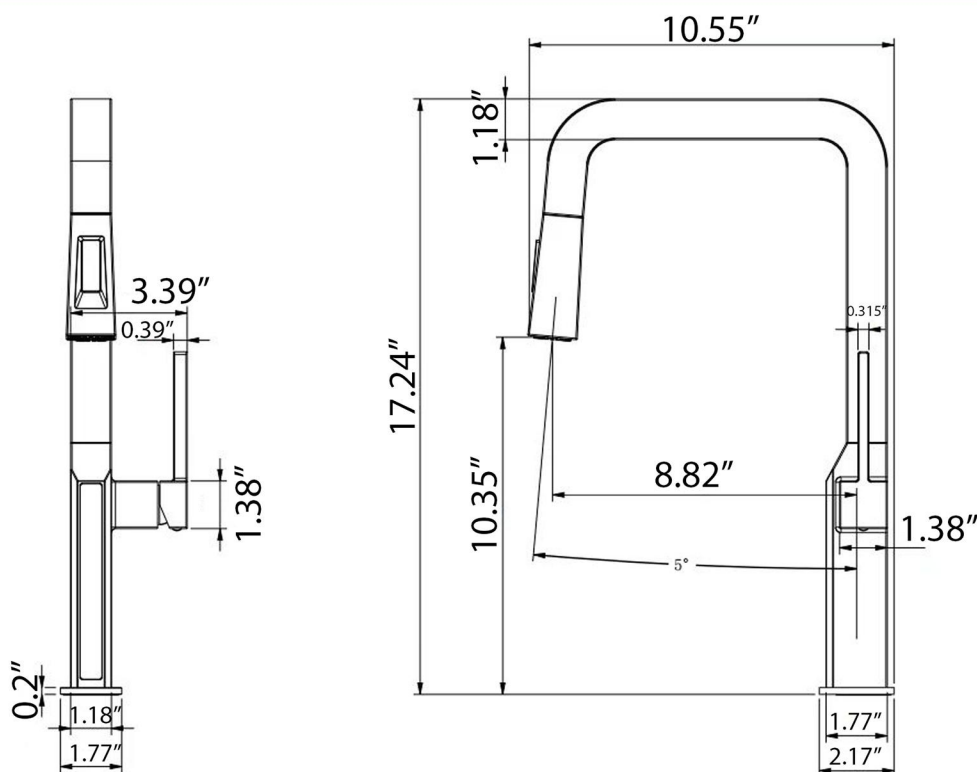

INSTALLATION STEPS

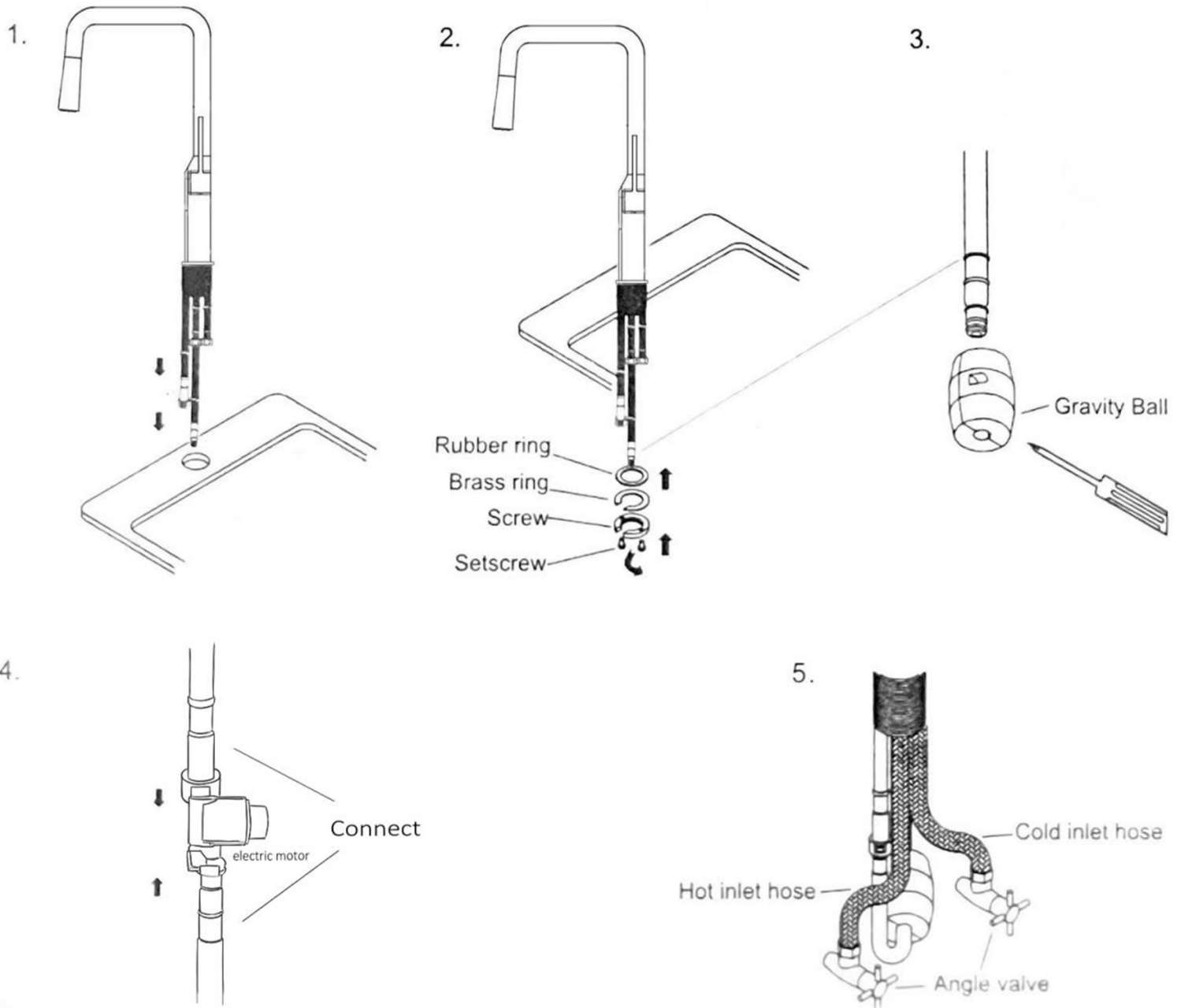

CLEANING CARE

In order to keep the appearance of product clean, bright and good performance, please take care of the product as follows;

1. Rinse with water only and dry with soft cotton cloth;
2. Use mild liquid and colorless glass cleaner to remove surface dirt and scale film, or use polish without abrasive effect;
3. Do not use abrasive detergent, polish, emery cloth, paper towel or scraper, etc;
4. Do not use acid cleaner, or cleaner and soap with insoluble gran etc;
5. In the process of use, mud may accumulate in the bubbler and make the water flow show, The bubbler can be unscrewed, rinsed with water, and then installed back in place.



Please feel free to contact us if you have any questions. We will help to solve the issue together with you. OUR EMAIL: services@rbrohant.com

