

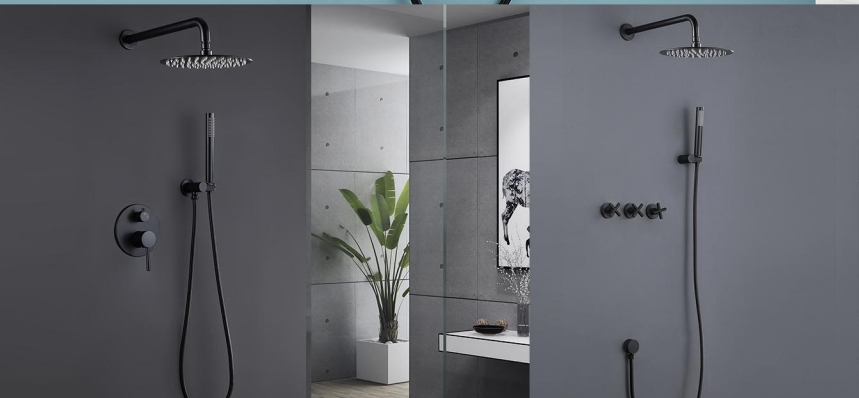

User's Manual



INSTALLATION INSTRUCTIONS

Installation Manual

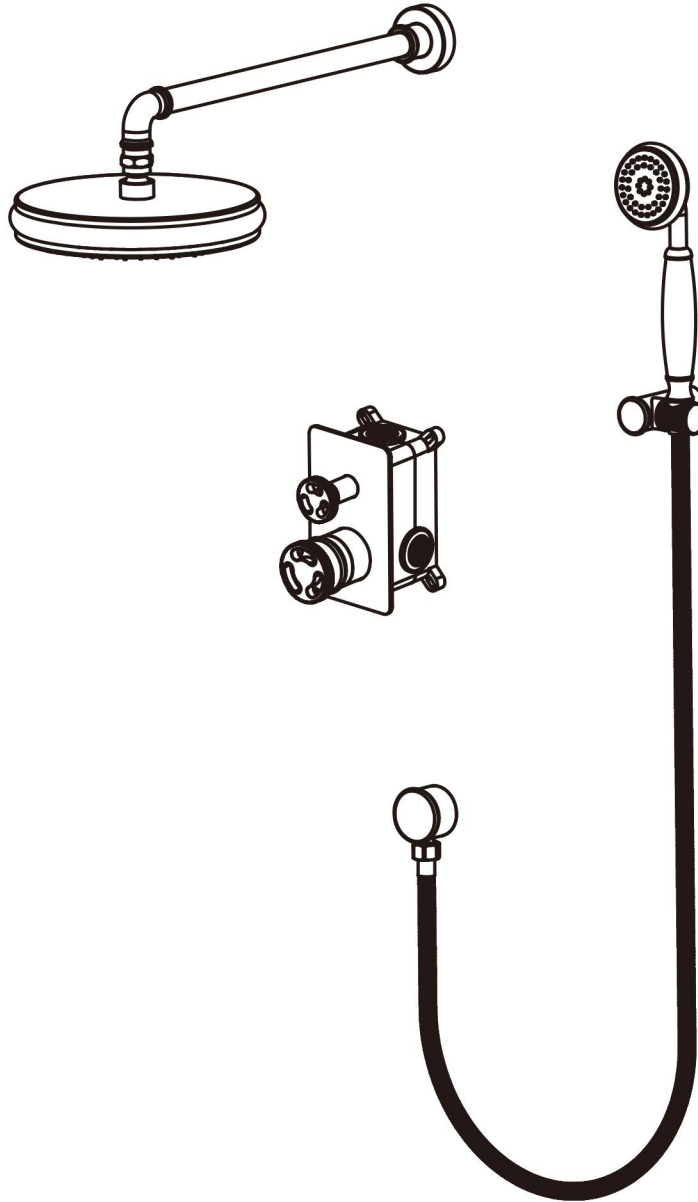

RB1147

IAPMO RESEARCH AND TESTING, INC.
5001 East Philadelphia Street, Ontario, California 91761-2816 • USA • 909-472-4100 • 909-472-4244 • www.iapmort.com





CERTIFICATE OF LISTING

UPC
C

IAPMO Research and Testing, Inc. is a product certification body which tests and inspects samples taken from the supplier's stock or from the market or a combination of both to verify compliance to the requirements of applicable codes and standards. This activity is coupled with periodic surveillance of the supplier's factory and warehouses as well as the assessment of the supplier's Quality Assurance System. This listing is subject to the conditions set forth in the characteristics below and shall be considered as any recommendation, assurance or guarantee by IAPMO Research and Testing, Inc. of the product except as by Authorized Listing Jurisdiction.

This certificate is not evidence of current listing. To verify listing status, visit the IAPMO R&T Product Listing Directory at pld.iapmo.org

Effective Date: December 2019 -Rev. 2/24/2020- Void After: December 2024
Product: Flexible Water Connectors File No. 5111
Issued To: Fanaki Group Inc., Mechanical & Electrical Industrial Zone, Yuhuan County, Yuhuan 317400, ZHEJIANG, China

Identification: Products shall be marked with manufacturer's name or trademark, a statement "For use with water in accessible locations only." The products shall also bear the cUPC® certification mark. Markings shall be by means of either a permanent mark on the product, a label on the product or a tag attached to the product.

Characteristics: Flexible water connectors manufactured in various sizes, lengths and metal and fittings for hot or cold water applications that consist of an inner tube, which may or may not have an outer braided cover. Connectors are to be installed for use in accessible locations only. To be installed in accordance with the manufacturer's instruction, and the latest edition of the Uniform Plumbing Code and National Plumbing Code of Canada.

Products listed on this certificate have been tested by an IAPMO R&T recognized laboratory. This recognition has been granted based upon the

Tom Collins Chairman, Product Certification Committee
Ran Cheng CEO, The IAPMO Group

This listing is based upon the test data and the results indicated on the Effective Date and Void After Date shown above. Any change in material, manufacturing process, marking or design without notifying first contact the approval of the Product Certification Committee, or any extension of manufacturing date shall be subject to the assessment of the supplier's Quality Assurance System. This listing is subject to the conditions set forth in the characteristics below and shall be considered as any recommendation, assurance or guarantee by IAPMO Research and Testing, Inc. of the product except as by Authorized Listing Jurisdiction. Any extension of this certificate shall be provided for re-evaluation of the listing. This document shall be reproduced in its entirety.

IAPMO RESEARCH AND TESTING, INC.
5001 East Philadelphia Street, Ontario, California 91761-2816 • USA • 909-472-4100 • 909-472-4244 • www.iapmort.com





CERTIFICATE OF LISTING

UPC
C

IAPMO Research and Testing, Inc. is a product certification body which tests and inspects samples taken from the supplier's stock or from the market or a combination of both to verify compliance to the requirements of applicable codes and standards. This activity is coupled with periodic surveillance of the supplier's factory and warehouses as well as the assessment of the supplier's Quality Assurance System. This listing is subject to the conditions set forth in the characteristics below and shall be considered as any recommendation, assurance or guarantee by IAPMO Research and Testing, Inc. of the product except as by Authorized Listing Jurisdiction.

This certificate is not evidence of current listing. To verify listing status, visit the IAPMO R&T Product Listing Directory at pld.iapmo.org

Effective Date: November 2019 Void After: November 2024
Product: Plumbing Fixture Fittings File No. 10633
Issued To: Aqua Gallery Co., Ltd 13th-15th AIO Block International Chemical Sanitary City, 528000 Foshan, China

Identification: Plumbing supply fittings complying with this Standard shall be marked with the manufacturer's recognized name, trademark, or other mark or, in the case of private labeling, the name, trademark or other mark of the customer for whom the fitting was manufactured. The marking shall be accomplished by use of a permanent mark or by placing a permanent label on the product. Markings on plumbing supply fittings shall be visible after installation.

Single-handle, single-control, and automatic compensating mixing bath and shower valves shall have identifiable temperature control settings in which the settings are indicated by words ("cold", "warm", "hot", etc.), by numbers, or graphically.

Package shall be marked with the manufacturer's name, trademark, or other mark as well as the model number or, in the case of private

Tom Collins Chairman, Product Certification Committee
Ran Cheng CEO, The IAPMO Group

This listing is based upon the test data and the results indicated on the Effective Date and Void After Date shown above. Any change in material, manufacturing process, marking or design without notifying first contact the approval of the Product Certification Committee, or any extension of manufacturing date shall be subject to the assessment of the supplier's Quality Assurance System. This listing is subject to the conditions set forth in the characteristics below and shall be considered as any recommendation, assurance or guarantee by IAPMO Research and Testing, Inc. of the product except as by Authorized Listing Jurisdiction. Any extension of this certificate shall be provided for re-evaluation of the listing. This document shall be reproduced in its entirety.

IAPMO RESEARCH AND TESTING, INC.
5001 East Philadelphia Street, Ontario, California 91761-2816 • USA • 909-472-4100 • 909-472-4244 • www.iapmort.com





CERTIFICATE OF LISTING

UPC
C

IAPMO Research and Testing, Inc. is a product certification body which tests and inspects samples taken from the supplier's stock or from the market or a combination of both to verify compliance to the requirements of applicable codes and standards. This activity is coupled with periodic surveillance of the supplier's factory and warehouses as well as the assessment of the supplier's Quality Assurance System. This listing is subject to the conditions set forth in the characteristics below and shall be considered as any recommendation, assurance or guarantee by IAPMO Research and Testing, Inc. of the product except as by Authorized Listing Jurisdiction.

This certificate is not evidence of current listing. To verify listing status, visit the IAPMO R&T Product Listing Directory at pld.iapmo.org

Effective Date: March 2019 Void After: March 2024
Product: Plumbing Fixture Fittings - Components File No. MC-9703
Issued To: Ningbo Nantai Cartridge Technology Co., Ltd, Linsen Zone, Chunhui Fuyuan, NINGBO 315518, China

Identification: Each fitting component shall bear permanent legible markings to identify the manufacturer. This marking shall be the trade name, trademark, or other mark known to identify the manufacturer. The product shall also bear all other markings required by the standards. The marking shall be applied so as to be visible after installation. The product or packaging shall also bear the cUPC® certification mark along with the term "COMPONENT" above.

Characteristics: Plumbing fixture fitting components to be installed in accordance with the manufacturer's instructions and the requirements of the latest edition of the Uniform Plumbing Code.

Products listed on this certificate have been tested by an IAPMO R&T recognized laboratory. This recognition has been granted based upon the Laboratory's compliance to the applicable requirements of ISO/IEC 17025.

Products are in compliance with the following code(s):
Uniform Plumbing Code (UPC®)

Tom Collins Chairman, Product Certification Committee
Ran Cheng CEO, The IAPMO Group

This listing is based upon the test data and the results indicated on the Effective Date and Void After Date shown above. Any change in material, manufacturing process, marking or design without notifying first contact the approval of the Product Certification Committee, or any extension of manufacturing date shall be subject to the assessment of the supplier's Quality Assurance System. This listing is subject to the conditions set forth in the characteristics below and shall be considered as any recommendation, assurance or guarantee by IAPMO Research and Testing, Inc. of the product except as by Authorized Listing Jurisdiction. Any extension of this certificate shall be provided for re-evaluation of the listing. This document shall be reproduced in its entirety.

BEFORE INSTALLATION

NO.	Item	Qty
1	Inner joint	1
2	Wall decoration cover	1
3	Shower arm	1
4	Rain shower head	1
5	Screw	4
6	Embedded box	1
7	Panel	1
8	Decorative cover	1
9	Water divider	1
10	Switch handwheel	1
11	Decorative cup	1
12	Hand shower seat	1
13	Shower hose	1
14	Hand shower bracket	1
15	Hand shower	1
16	Accessory bag	1

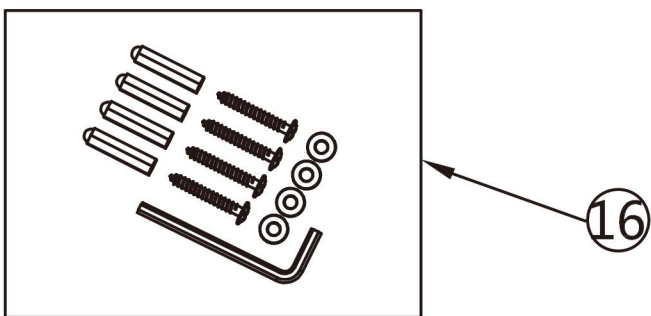
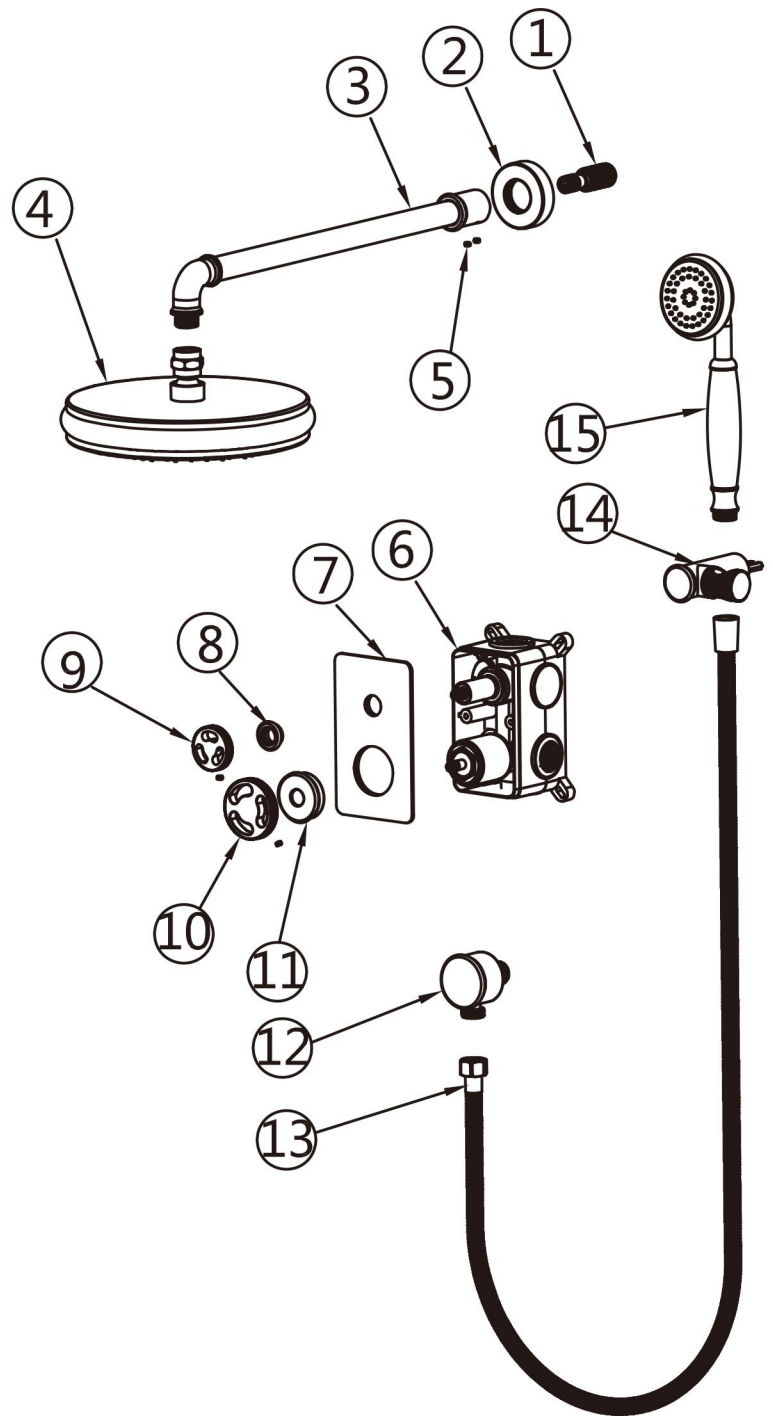

Check accessories

Standard List of Accessories:

When you open the product packaging, please check whether the objects in it are consistent with the main body and accessories you purchased. If there is any inconsistency, please contact our company or our distributor.

Note: 1. Accessories are subject to change without prior notice if the change does not affect usage;

2. The appearance of the product is subject to the physical objects you receive, and the schematic diagram is only for reference.

INSTALLATION STEPS

This product has been inspected and debugged by the factory to the best condition. Please do not disassemble and assemble it yourself.

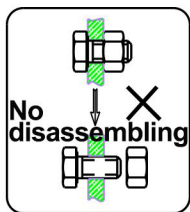

Before installing the product, please be sure to remove sundries and sludge from the water pipe to prevent sundries from blocking the product.

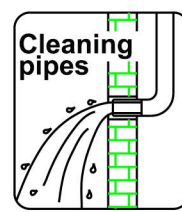

1. Waterway display map

- 1). The minimum opening size of the wall box is 6.3"x3.94", the depth is 2.56"~2.83", and the depth is less than 2.83" is the best (Note: The depth dimension is the size of the tile attached to the wall. If it is installed on the wall, please reserve the appropriate tile thickness)
- 2). Please flush all pipes before installation.
- 3). Special attention must be paid to the hot and cold water pipes of the embedded box: the left side is hot water, and the right side is cold water.
- 4). After the water test is completed and it is confirmed that there is no leakage, cement packing can be used to seal the pipeline and the embedded box.

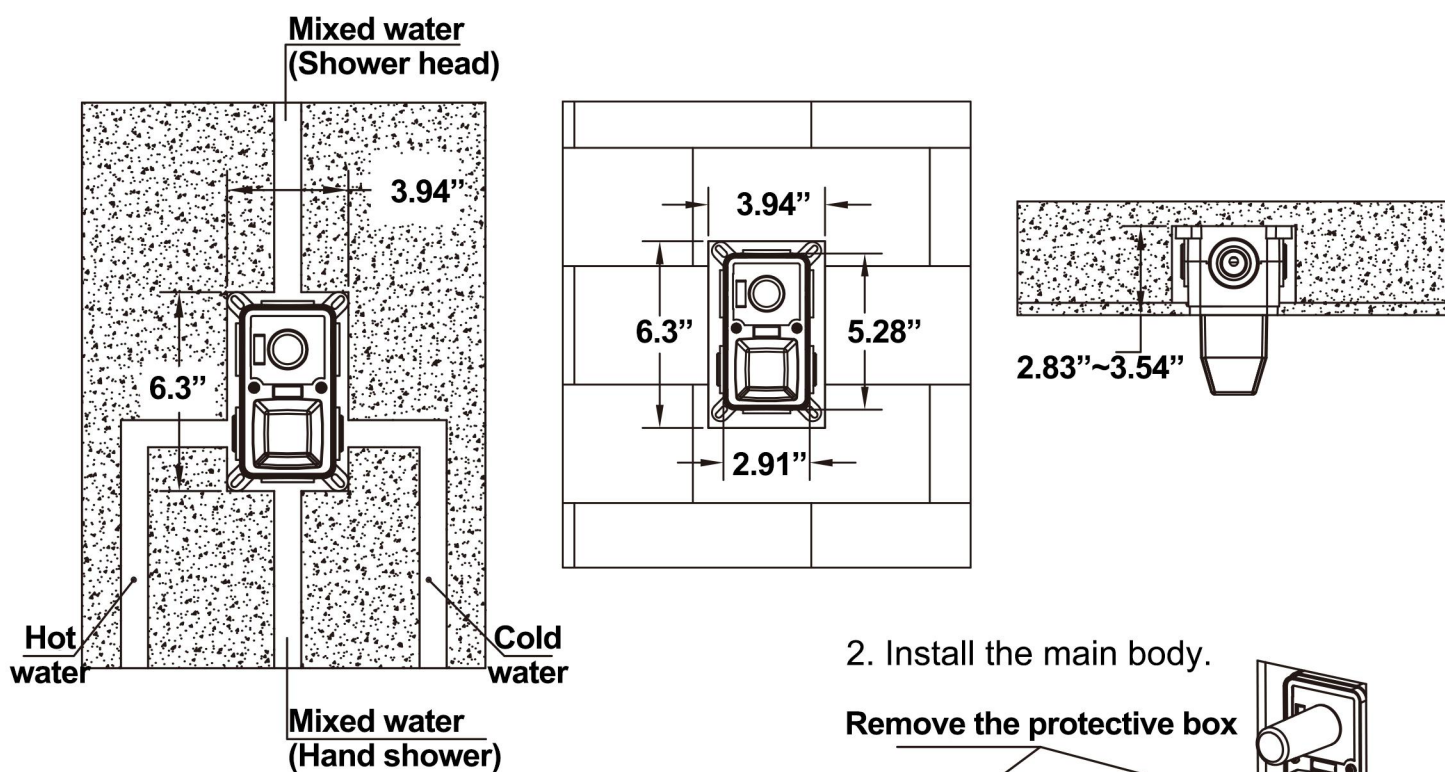

3. Install the upper outlet pipe and the top shower head. (wrap the PTFE tape on the thread)

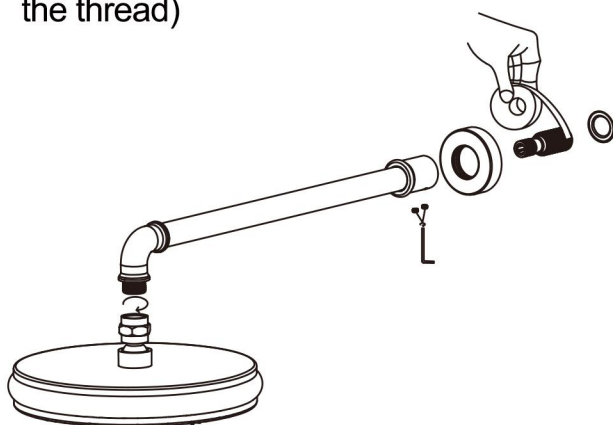

2. Install the main body.

Remove the protective box

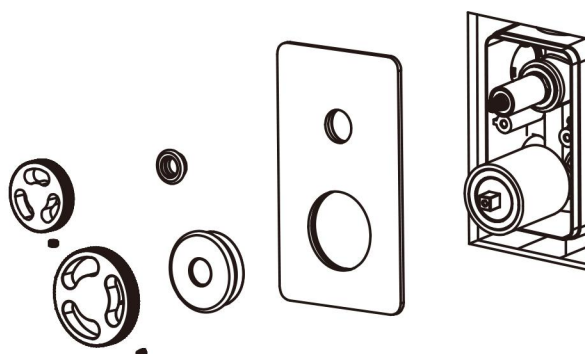
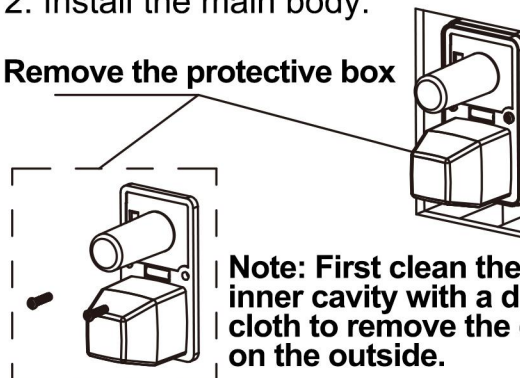

INSTALLATION STEPS

4. Install the hand shower bracket (wrap the PTFE tape on the thread) and the shower seat.

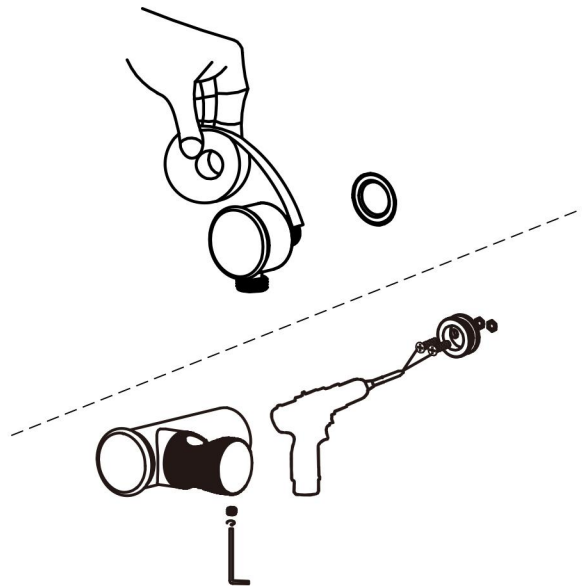

5. Schematic diagram of product installation completed.

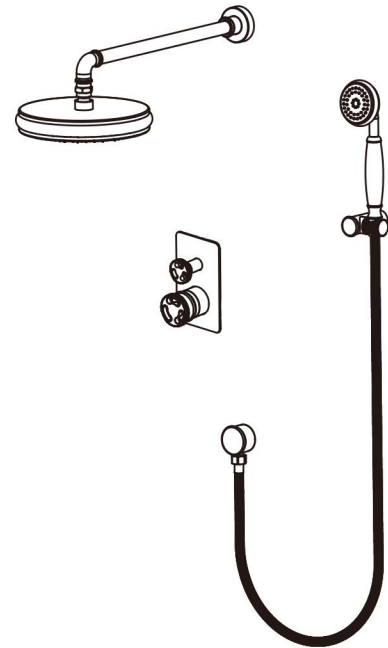

INSTALLATION DIMENSION

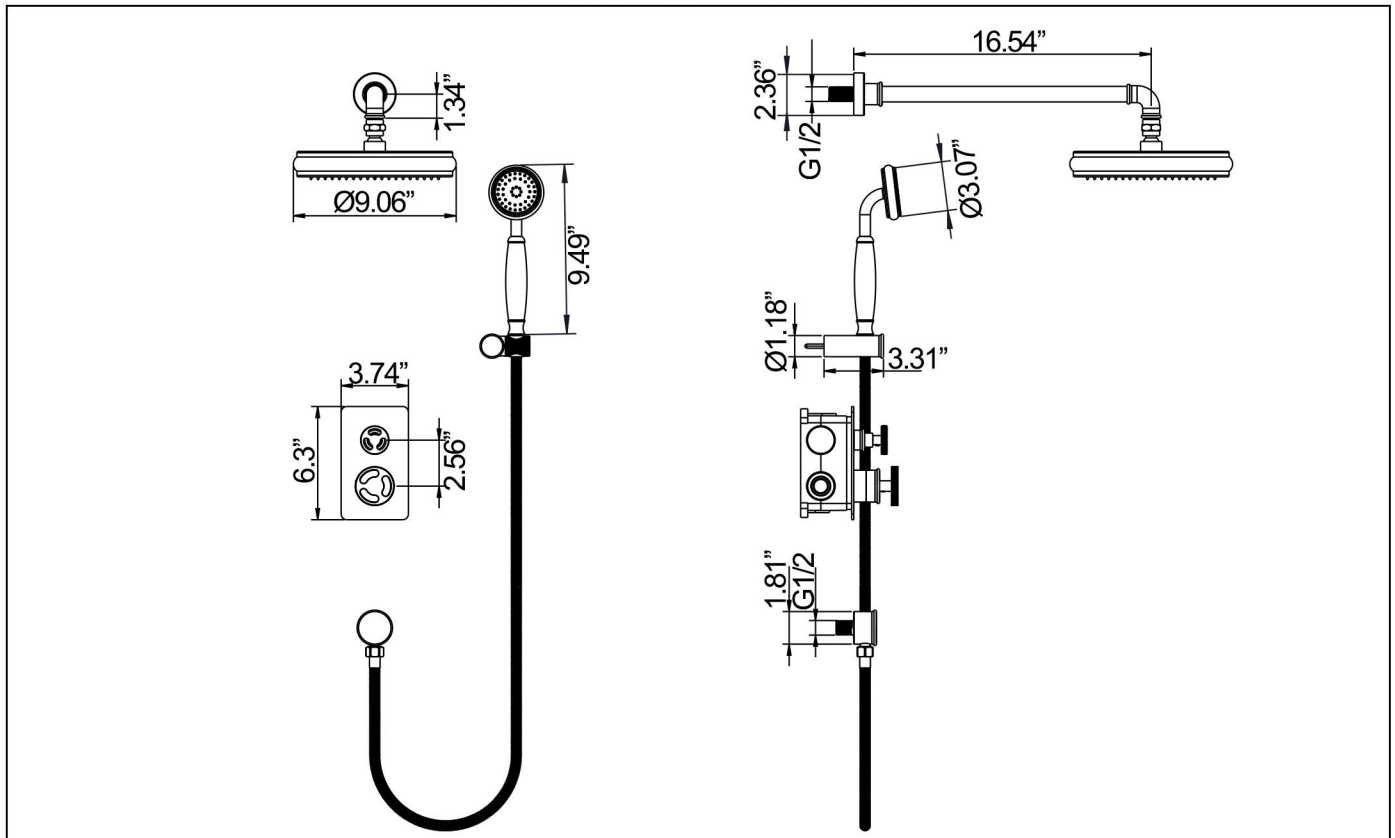

CLEANING CARE

In order to keep the appearance of product clean, bright and good performance, please take care of the product as follows;

1. Rinse with water only and dry with soft cotton cloth;
2. Use mild liquid and colorless glass cleaner to remove surface dirt and scale film, or use polish without abrasive effect;
3. Do not use abrasive detergent, polish, emery cloth, paper towel or scraper, etc;
4. Do not use acid cleaner, or cleaner and soap with insoluble gran etc;
5. In the process of use, mud may accumulate in the bubbler and make the water flow show, The bubbler can be unscrewed, rinsed with water, and then installed back in place.



Please feel free to contact us if you have any questions. We will help to solve the issue together with you. OUR EMAIL: services@rbrohant.com



Service Contact:
+1(801) 800-9309
services@rbrohant.com

Made in China