



User's Manual



INSTALLATION INSTRUCTIONS

Installation Manual

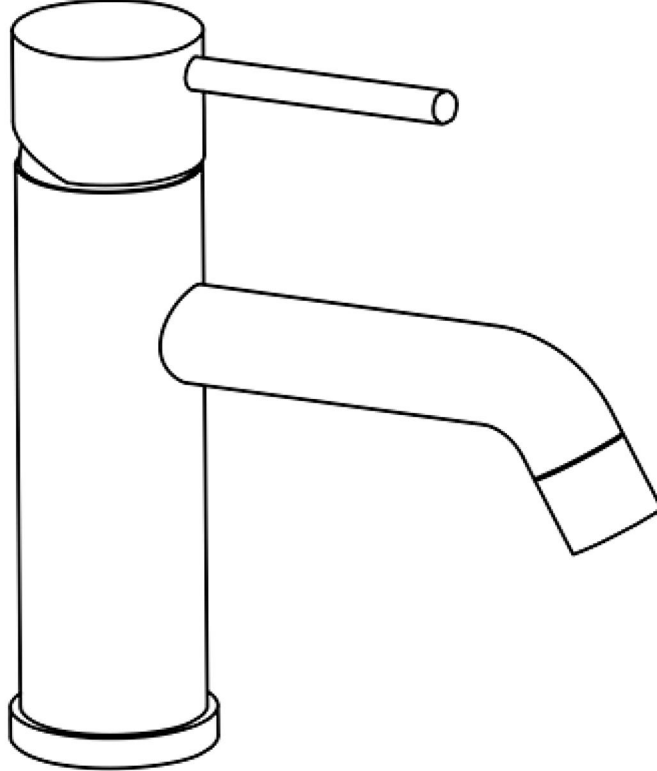

RB0960

IAPMO RESEARCH AND TESTING, INC.
5001 East Philadelphia Street, Ontario, California 91761-2816 • USA • 909-472-4100 • 909-472-4244 • www.iapmort.com

CERTIFICATE OF LISTING

 This certificate is not evidence of current listing. To verify listing status, visit the IAPMO R&T Product Listing Directory at pld.iapmo.org

Effective Date: December 2019 -Rev. 2/24/2020- Void After: December 2024
Product: Flexible Water Connectors File No. 5111
Issued To: Fanaki Group Inc.
Mechanical & Electrical
Industrial Zone,
Yuhuan County,
Yuhuan 317800, ZHEJIANG
China

Identification: Products shall be marked with manufacturer's name or trademark, a statement "For use with water in accessible locations only." The product shall also bear the cUPC® certification mark. Markings shall be by means of either a permanent mark on the product, a label on the product or a tag attached to the product.

Characteristics: Flexible water connectors manufactured in various sizes, lengths and metal and fittings for hot or cold water applications that consist of an inner tube, which may or may not have an outer braided cover. Connectors are to be installed for use in accessible locations only. To be installed in accordance with the manufacturer's instruction, and the latest edition of the Uniform Plumbing Code and National Plumbing Code of Canada.

Products listed on this certificate have been tested by an IAPMO R&T recognized laboratory. This recognition has been granted based upon the

Chairman, Product Certification Committee CEO, The IAPMO Group

This listing is based upon the test data on the reports indicated on the Effective Date and Void After Date shown above. Any change in material, manufacturing process, marking or design without having first obtained the approval of the Product Certification Committee, or any violation of the applicable code and standards, shall be deemed sufficient cause for revocation of this listing. Products of or referred to in this form for advertising purposes may be made only by specific written permission of IAPMO Research and Testing, Inc. Any alteration of this certificate could be grounds for revocation of this listing. This document shall be reproduced in its entirety.

IAPMO RESEARCH AND TESTING, INC.
5001 East Philadelphia Street, Ontario, California 91761-2816 • USA • 909-472-4100 • 909-472-4244 • www.iapmort.com

CERTIFICATE OF LISTING

 This certificate is not evidence of current listing. To verify listing status, visit the IAPMO R&T Product Listing Directory at pld.iapmo.org

Effective Date: November 2019 Void After: November 2024
Product: Plumbing Fixture Fittings File No. 10613
Issued To: Aqua Gallery Co., Ltd
11th-15th A/D Block
Sanitary City, 528000
Foshan,
China

Identification: Plumbing supply fittings complying with this Standard shall be marked with the manufacturer's recognized name, trademark, or other mark or, in the case of private labeling, the name, trademark or other mark of the customer for whom the fitting was manufactured. The marking shall be accomplished by use of a permanent mark or by placing a permanent label on the product. Markings on plumbing supply fittings shall be visible after installation.

Single-handle, single-control, and automatic compensating mixing bath and shower valves shall have identifiable temperature control settings in which the settings are indicated by words ("cold", "warm", "hot", etc.), by numbers, or graphically.

Packages shall be marked with the manufacturer's name, trademark, or other mark as well as the model number or, in the case of private

Chairman, Product Certification Committee CEO, The IAPMO Group

This listing is based upon the test data on the reports indicated on the Effective Date and Void After Date shown above. Any change in material, manufacturing process, marking or design without having first obtained the approval of the Product Certification Committee, or any violation of the applicable code and standards, shall be deemed sufficient cause for revocation of this listing. Products of or referred to in this form for advertising purposes may be made only by specific written permission of IAPMO Research and Testing, Inc. Any alteration of this certificate could be grounds for revocation of this listing. This document shall be reproduced in its entirety.

IAPMO RESEARCH AND TESTING, INC.
5001 East Philadelphia Street, Ontario, California 91761-2816 • USA • 909-472-4100 • 909-472-4244 • www.iapmort.com

CERTIFICATE OF LISTING

 This certificate is not evidence of current listing. To verify listing status, visit the IAPMO R&T Product Listing Directory at pld.iapmo.org

Effective Date: March 2019 Void After: March 2024
Product: Plumbing Fixture Fittings - Components File No. MC-9703
Issued To: Ningbo Nantai Cartridge Technology Co., Ltd.
Linchou Zone, Chunhui
Fengpu, NINGBO 315518
China

Identification: Each fitting component shall bear permanent legible markings to identify the manufacturer. This marking shall be the trade name, trademark, or other mark known to identify the manufacturer. The product shall also bear all other markings required by the standards. The marking shall be applied so as to be visible after installation. The product or packaging shall also bear the cUPC® certification mark along with the term "COMPONENT" above.

Characteristics: Plumbing fixture fitting components to be installed in accordance with the manufacturer's instructions and the requirements of the latest edition of the Uniform Plumbing Code.

Products listed on this certificate have been tested by an IAPMO R&T recognized laboratory. This recognition has been granted based upon the Laboratory's compliance to the applicable requirements of ISO/IEC 17025.

Products are in compliance with the following code(s):
Uniform Plumbing Code (UPC®)

  

Chairman, Product Certification Committee CEO, The IAPMO Group

This listing is based upon the test data on the reports indicated on the Effective Date and Void After Date shown above. Any change in material, manufacturing process, marking or design without having first obtained the approval of the Product Certification Committee, or any violation of the applicable code and standards, shall be deemed sufficient cause for revocation of this listing. Products of or referred to in this form for advertising purposes may be made only by specific written permission of IAPMO Research and Testing, Inc. Any alteration of this certificate could be grounds for revocation of this listing. This document shall be reproduced in its entirety.

INSTALLATION STEPS

This product has been inspected and debugged by the factory to the best condition. Please do not disassemble and assemble it yourself.

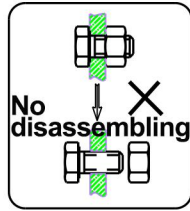

Before installing the product, please be sure to remove sundries and sludge from the water pipe to prevent sundries from blocking the product.



1. Shut off the water supplies before installation. Remove the current faucet and clean and dry the sink surface the new faucet will be installed on.

2. Unscrew the lock nut and gasket assembly.

Please Note: Do not remove the customer service tag with the model number and phone number as this will be helpful if you need assistance in the future.

3. Apply teflon tape on the threads of the faucet cold & hot water supply tubes in a clockwise direction.

4. For Single Hole Installation-Place silicone sealant beneath the faucet base and install the faucet through the single faucet hole.

5. Attach gasket assembly and lock nut from the bottom.

Please Note: Please assemble in numerical order. Tighten but do not over tighten. Use a phillips screwdriver to tighten the 3-screws on the lock nut.

See diagram for visual. Hint - Easier to do with a second person holding the faucet in place while the first person tightens the faucet.

6. Please connect the faucet body with the cold and hot water supply tubes and keep the outer threads side into the body. Keep the hot water tube on the left side and the cold one on the right side, and then tighten.

7. Connect the water supply tube of the faucet with the water supply angle valve, tighten the 9/16" npt with the wrench.

Please Note: No need to use teflon tape for angle valve nut, just tighten it with the wrench directly.

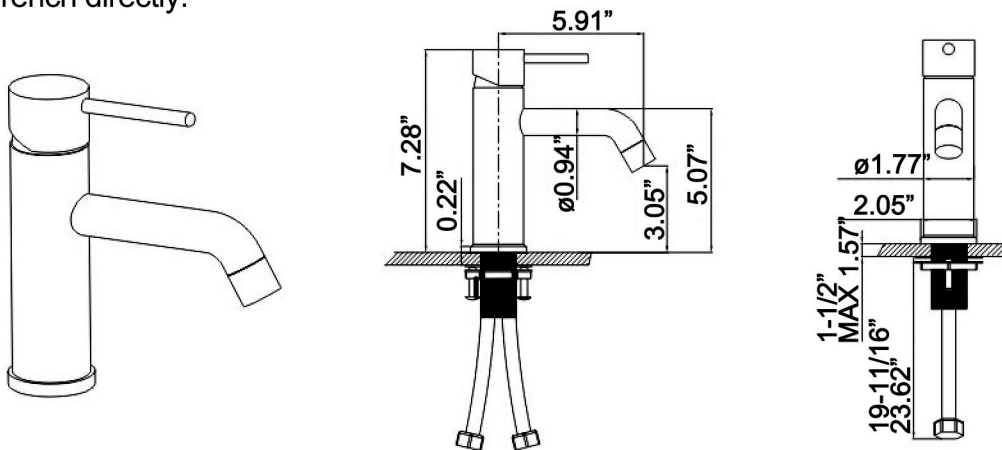
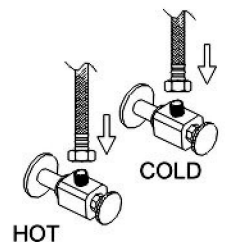
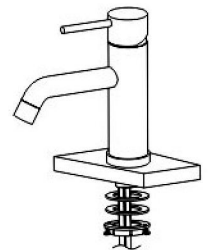
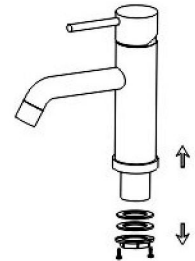
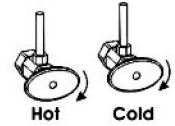

CLEANING CARE

In order to keep the appearance of product clean, bright and good performance, please take care of the product as follows;

1. Rinse with water only and dry with soft cotton cloth;
2. Use mild liquid and colorless glass cleaner to remove surface dirt and scale film, or use polish without abrasive effect;
3. Do not use abrasive detergent, polish, emery cloth, paper towel or scraper, etc;
4. Do not use acid cleaner, or cleaner and soap with insoluble gran etc;
5. In the process of use, mud may accumulate in the bubbler and make the water flow show, The bubbler can be unscrewed, rinsed with water, and then installed back in place.



Please feel free to contact us if you have any questions. We will help to solve the issue together with you. OUR EMAIL: services@rbrohant.com



Service Contact:
+1(801) 800-9309
services@rbrohant.com

Made in China