

INSTALLATION AND ADJUSTMENT OF HINGES (if required)

HOOD 1-30

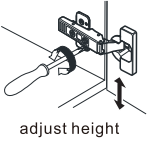

adjust height

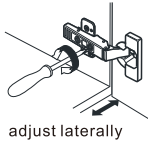

adjust laterally

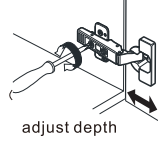

adjust depth

TOOLS FOR ASSEMBLY

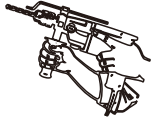

electric drill



Ø6mm drill bit

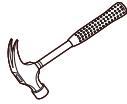

hammer



Pencil



Phillips Screwdriver



Tape measure



Silicone Sealant

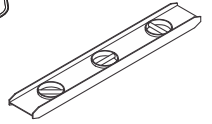

Spirit Level

Accessories

Expansion tube and H4X50 self-tapping screws



3 Sets

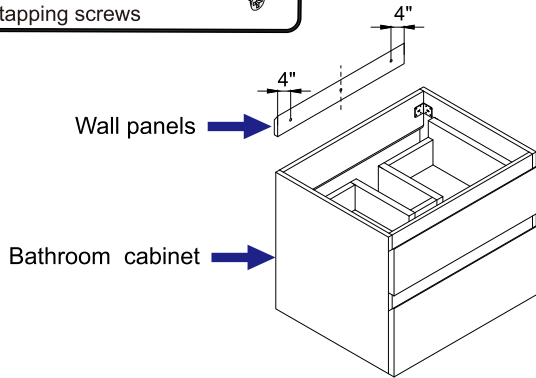

Wall panels

Bathroom cabinet

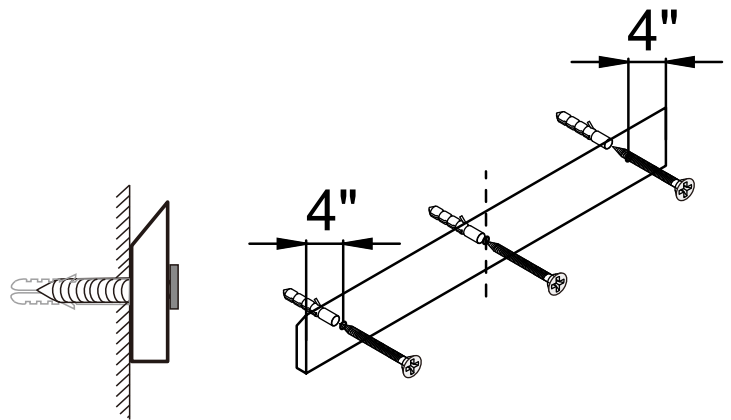

Install the wall panel

(1)

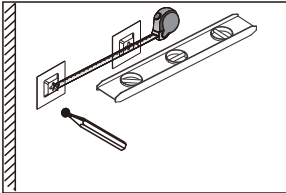

Mark the hole location

(2)

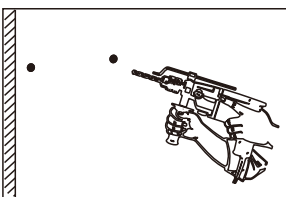

Drill holes with electric Drill

(3)

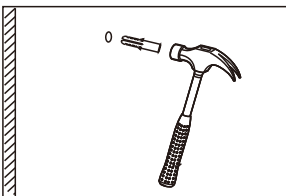

Fixed expansion tube

(4)

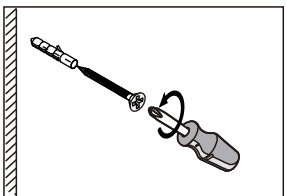

Use matching screws to secure wall panels

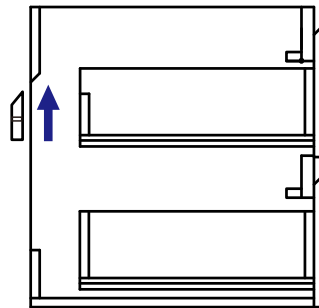

Hang the bathroom cabinet onto the wall panel

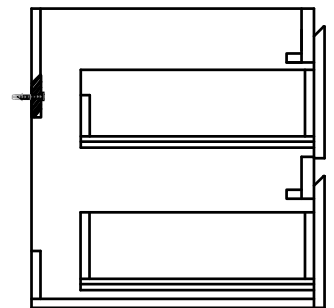

Fix the bathroom cabinet and wall panel

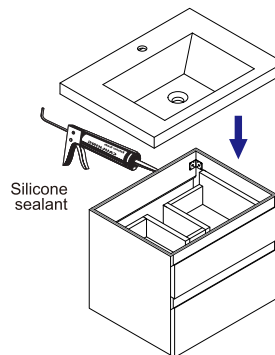

Silicone sealant

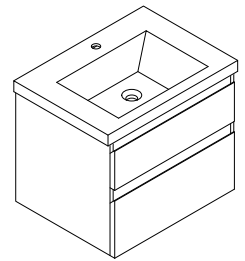

Install the sink, seal around the top of the cabinet with clear silicone sealant. Do not over apply. Allow to dry 24 hours for proper curing.

INSTALLATION GUIDE