

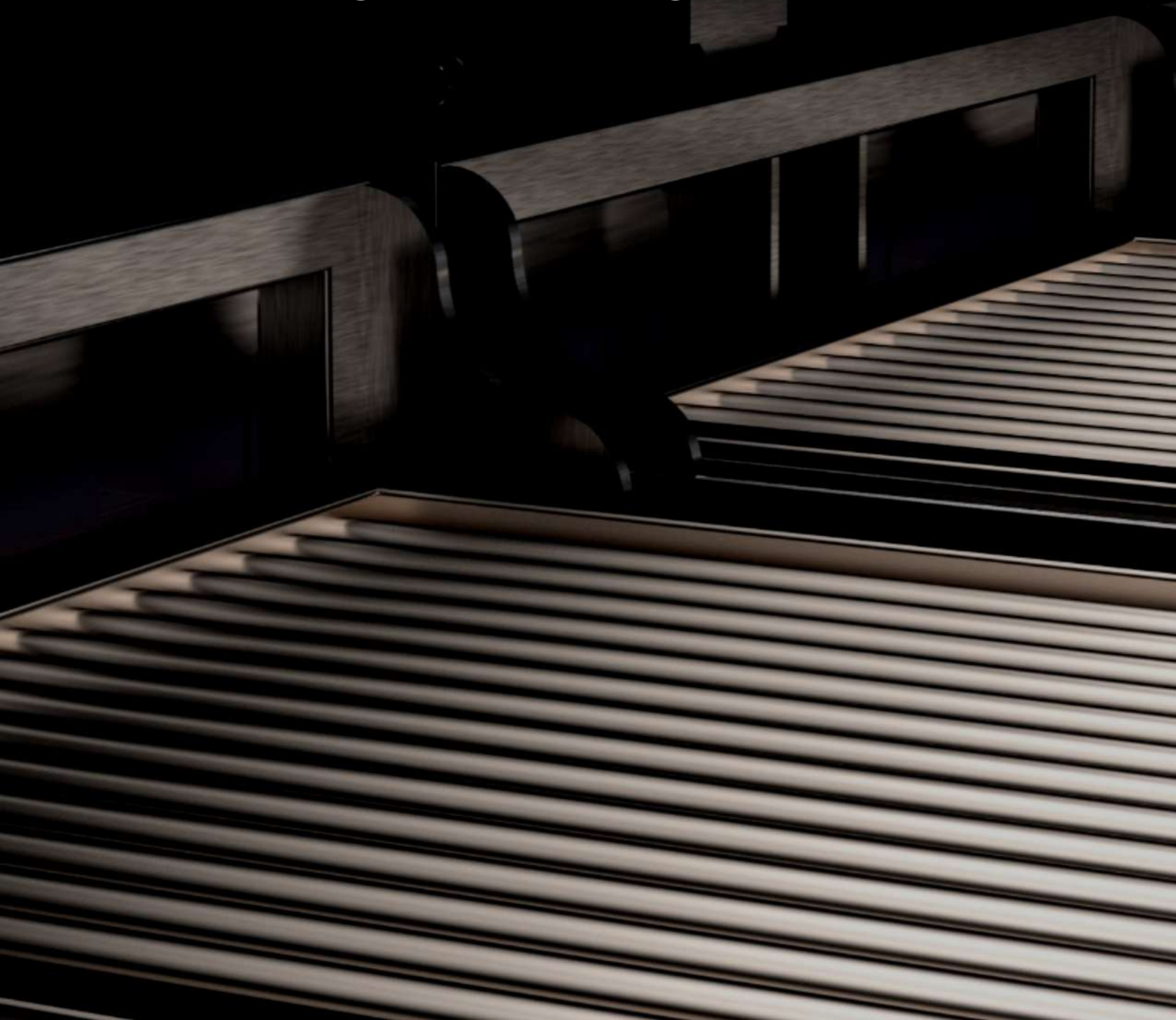

Ignite Your Imagination







Cold



Hot



Ambient



Radiant

The core products produced are commercial appliances for the food service industry.

MISSION STATEMENT

“To continuously invigorate the culinary experience through research & development, innovative designs, the latest technology, and creative manufacturing techniques.”

VISION STATEMENT

“To bring the highest quality product on the market to our customers.”

About CHAR[®] Products, LLC.

CHAR[®] is a United States based manufacturing company located in the heart of the entertainment industry: Las Vegas, Nevada. The company was founded in 2016 by the Blazvick family, a long-standing name in the culinary industry of custom fabrication. The Blazvick's have over 30 years of consistent, not combined, experience in commercial kitchen, design, fabrication, and service. CHAR[®] focuses on front of house commercial appliances that promise to give a real “WOW” factor along with a Radiant experience for the customer while producing the most exciting food products available. With a full line up of products, crossing all 3 temperature zones, you can be assured that your next project will find the right, “Appliance with Soul™.”

Las Vegas brings a unique perspective when designing culinary equipment. The 24/7 use and non-stop operations means that products must be designed and manufactured to the highest level of standards. All CHAR[®] Products are just that: heavy duty engineered designs which allow extreme use daily while holding an appeal that brings the front of house alive.

3D modeling technology, state of the art fabrication techniques, and highly trained skilled craftsman allow CHAR[®] to bring any imaginative idea to reality. We design, engineer, and test to NSF, ETL, and/or UL standards as needed for each product and have even developed/patented several products which bring a creative appeal to the culinary world. Working closely with design consultants, our team can engineer any custom one-off product needed.

Contact our sales team for your next project and let CHAR[®] truly Ignite Your Imagination.



Cold



CHAR[®] Products produces refrigerated equipment ranging from wine cases to dessert cases to meat aging display cases.





ITEM NO	
QUANTITY	
JOB NAME	
JOB NO	

WINE DISPLAY CASE SPECIFICATION SHEET



SPECIFICATIONS

CHAR® Products has over 20 years experience designing, engineering and manufacturing Wine Display Cases. Our products reside all over the United States, in some of the most prestigious establishments. Each display is custom designed to each clients specifications. Every client option request is taken and engineered into the design. Each element is evaluated for performance and conformity to ETL/ NSF7/UL safety standards. Each case is tested and certified at our facility before shipment.

Contact our sales team and see what we can do for your next Wine Display Case project.

AVAILABLE MODELS

CP-WDC-XX-XX

FIRST -XX DESIGNATES REMOTE (RR) OR SELF-CONTAINED (SC) REFRIGERATION.

SECOND -XX DESIGNATES LENGTH OF UNIT IN INCHES.

STANDARD FEATURES

- Stainless steel interior and exterior
- LEED certified foamed in place high density polyurethane insulation
- Curb mounted
- Heavy duty CHAR proprietary door hinging
- Glass doors, thermal dual pane, LI glass
- Stylish full height door handles
- Door locks
- Standard tubular wine racking
- Standard non UV - LED lighting
- Two year warranty: parts and labor

OPTIONS

CUSTOM WINE DISPLAY RACKING

CUSTOM LED LIGHTING OPTIONS

CUSTOM INTERIOR / EXTERIOR FINISH

GLASS TINTS, NON-GLARE

SINGLE ZONE REFRIGERATION

DUAL ZONE REFRIGERATION

MULTIPLE ZONE REFRIGERATION

**** ZONE TYPE MUST BE SPECIFIED ****

**** REFRIGERANT TYPE MUST BE SPECIFIED ****

CONSULTANT APPROVAL: _____

REFRIGERANT TYPE: _____

DATE: _____



CHAR Products, LLC

Ph. 702-489-9888
Fax. 702-489-9898

1

Website: www.charprd.com
Email: info@charprd.com

2915 Lasse Rd. Ste 106
N. Las Vegas, NV 89030

Printed in USA—Jan. 2020

© copyright 2020



ITEM NO	
QUANTITY	
JOB NAME	
JOB NO	

MEAT AGING DISPLAY CASE SPECIFICATION SHEET



AVAILABLE MODELS

<input type="checkbox"/>	CP-MDC-XX-XX
FIRST -XX DESIGNATES REMOTE (RR) OR SELF-CONTAINED (SC) REFRIGERATION.	
SECOND -XX DESIGNATES LENGTH OF UNIT IN INCHES.	

STANDARD FEATURES

- Stainless steel interior and exterior
- LEED certified foamed in place high density polyurethane insulation
- Humidity and temperature monitoring
- 6" legs
- Heavy duty CHAR proprietary door hinging
- Glass doors, thermal dual pane, LI glass
- Stylish full-height door handles
- Door locks
- Standard adjustable stainless steel shelving
- Meat hooks and hanging bars
- Two year warranty: parts and labor

SPECIFICATIONS

CHAR® Products has over 20 years experience designing, engineering and manufacturing Meat Aging Display Cases. Our products reside all over the United States, in some of the most prestigious establishments. Each display is custom designed to each clients specifications. Every client option request is taken and engineered into the design. Each element is evaluated for performance and conformity to ETL/ NSF7/UL safety standards. Each case is tested and certified at our facility before shipment.

Contact our sales team and see what we can do for your next Meat Aging Display Case project.

OPTIONS

<input type="checkbox"/>	CUSTOM DISPLAY SHELVING
<input type="checkbox"/>	CUSTOM LED LIGHTING OPTIONS
<input type="checkbox"/>	CUSTOM INTERIOR/ EXTERIOR FINISH
<input type="checkbox"/>	GLASS TINTS

** REFRIGERANT TYPE MUST BE SPECIFIED **

CONSULTANT APPROVAL: _____
REFRIGERANT TYPE: _____
DATE: _____



CHAR Products, LLC Ph. 702-489-9888 Fax. 702-489-9898	1	Website: www.charprd.com Email: info@charprd.com	2915 Lussie Rd. Ste 106 N. Las Vegas, NV 89030
--	---	--	---

Printed in USA—Jan. 2020

© copyright 2020



ITEM NO	
QUANTITY	
JOB NAME	
JOB NO	

EQUIPMENT BASE REFRIGERATED

SPECIFICATION SHEET



CP-EBR-DW-72
WITH SELF CONTAINED REFRIGERATION

AVAILABLE MODELS

WITH DOORS	WITH DRAWERS
<input type="checkbox"/> CP-EBR-36	<input type="checkbox"/> CP-EBR-DW-36
<input type="checkbox"/> CP-EBR-48	<input type="checkbox"/> CP-EBR-DW-48
<input type="checkbox"/> CP-EBR-60	<input type="checkbox"/> CP-EBR-DW-60
<input type="checkbox"/> CP-EBR-72	<input type="checkbox"/> CP-EBR-DW-72

STANDARD FEATURES

- Stainless steel interior and exterior
- LEED certified foamed in place high density polyurethane insulation
- Heavy duty 6" adjustable legs
- Digital temperature control
- Doors or drawers include full perimeter magnetic gaskets
- Stainless steel adjustable wire shelf included with door models
- Full extension slide assemblies included with drawer models
- Two year warranty: parts and labor
- Five year warranty: compressor

SPECIFICATIONS

CHAR® Products has over 20 years experience designing, engineering and manufacturing Refrigerated Equipment Bases. Our products reside all over the United States.

Contact our sales team if you require a custom Refrigerated Base solution for your project.

OPTIONS

<input type="checkbox"/> SELF-CONTAINED REFRIGERATION
<input type="checkbox"/> REMOTE REFRIGERATION
<input type="checkbox"/> R404a REFRIGERANT
<input type="checkbox"/> R134a REFRIGERANT
<input type="checkbox"/> FOUR 6" ROLLING CASTERS (TWO LOCKING)

** REFRIGERANT TYPE MUST BE SPECIFIED **

CONSULTANT APPROVAL:
NOTES:
DATE:



CHAR Products, LLC	Ph. 702-489-9888 Fax. 702-489-9898	1	Website: www.charprd.com Email: info@charprd.com	2915 Lowe Rd Ste 106 N. Las Vegas, NV 89030
--------------------	---------------------------------------	---	---	--

Printed in USA—Jan. 2020

© copyright 2020



APPLIANCES WITH SOUL™

MODEL #	LENGTH	ELECTRIC	BTU H	SHIPPING WEIGHT EST.
CP-EBR-36	36"	120V-1PH-10A	1100	300 LBS.
CP-EBR-48	48"	120V-1PH-10A	1300	325 LBS.
CP-EBR-60	60"	120V-1PH-10A	1500	350 LBS.
CP-EBR-72	72"	120V-1PH-10A	1700	400 LBS.

MODEL #	LENGTH	ELECTRIC	BTU H	SHIPPING WEIGHT EST.
CP-EBR-DW-36	36"	120V-1PH-10A	1100	350 LBS.
CP-EBR-DW-48	48"	120V-1PH-10A	1300	375 LBS.
CP-EBR-DW-60	60"	120V-1PH-10A	1500	400 LBS.
CP-EBR-DW-72	72"	120V-1PH-10A	1700	450 LBS.



NOTE: THE NUMBER AND SIZE OF DRAWERS OR DOORS CHANGE WITH THE UNIT SIZE. ACTUAL DIMENSIONS WILL BE FINALIZED IN THE APPROVAL DRAWINGS.

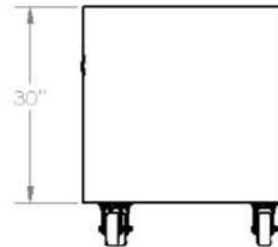
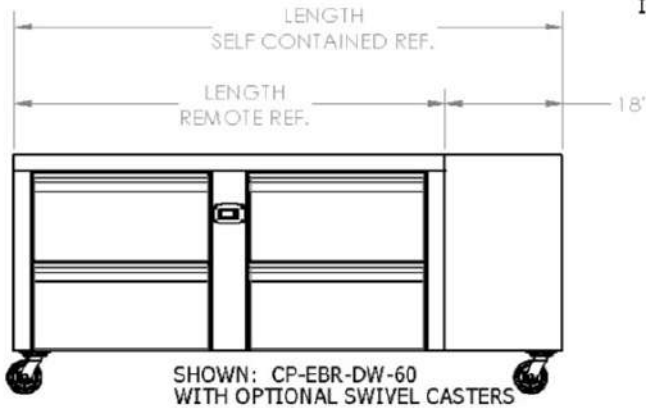

INSTALLATION INSTRUCTIONS

1. Observe all local and national codes.
2. This appliance is manufactured for commercial use ONLY. It is NOT intended for residential indoor use.
3. We upgrade our products regularly and in doing so, materials, specifications, and model numbers are subject to change without notice.

CHAR Products, LLC

Ph. 702-489-9888
Fax. 702-489-9898

Website: www.charprd.com
Email: info@charprd.com

2915 Leaxe Rd. Ste 106
N. Las Vegas, NV 89030



ITEM NO	
QUANTITY	
JOB NAME	
JOB NO	

EQUIPMENT BASE FREEZER

SPECIFICATION SHEET



CP-EBF-DW-72
SHOWN WITH OPTIONAL SWIVEL CASTERS

AVAILABLE MODELS

WITH DOORS	WITH DRAWERS
<input type="checkbox"/> CP-EBF-36	<input type="checkbox"/> CP-EBF-DW-36
<input type="checkbox"/> CP-EBF-48	<input type="checkbox"/> CP-EBF-DW-48
<input type="checkbox"/> CP-EBF-60	<input type="checkbox"/> CP-EBF-DW-60
<input type="checkbox"/> CP-EBF-72	<input type="checkbox"/> CP-EBF-DW-72

STANDARD FEATURES

- Stainless steel interior and exterior
- LEED certified foamed in place high density polyurethane insulation
- Heavy duty 6" adjustable legs
- Digital temperature control
- Doors or drawers include full perimeter magnetic gaskets
- Stainless steel adjustable wire shelf included with door models
- Full extension slide assemblies included with drawer models
- Two year warranty: parts and labor
- Five year warranty: compressor

SPECIFICATIONS

CHAR® Products has over 20 years experience designing, engineering and manufacturing Equipment Base Freezers. Our products reside all over the United States.

Contact our sales team if you require a custom Refrigerated Base solution for your project.

OPTIONS

<input type="checkbox"/> SELF-CONTAINED REFRIGERATION
<input type="checkbox"/> REMOTE REFRIGERATION
<input type="checkbox"/> R404a REFRIGERANT
<input type="checkbox"/> R134a REFRIGERANT
<input type="checkbox"/> FOUR 6" ROLLING CASTERS (TWO LOCKING)

** REFRIGERANT TYPE MUST BE SPECIFIED **

CONSULTANT APPROVAL: _____
NOTES: _____
DATE: _____



CHAR Products, LLC Ph. 702-489-9888
Fax. 702-489-9898

Website: www.charprd.com
Email: info@charprd.com

2915 Losee Rd. Ste 106
N. Las Vegas, NV 89030



APPLIANCES WITH SOUL™

MODEL #	LENGTH	ELECTRIC	BTU H	SHIPPING WEIGHT EST.	MODEL #	LENGTH	ELECTRIC	BTU H	SHIPPING WEIGHT EST.
CP-EBF-36	36"	120V-1PH-10A	1100	300 LBS.	CP-EBF-DW-36	36"	120V-1PH-10A	1100	300 LBS.
CP-EBF-48	48"	120V-1PH-10A	1300	325 LBS.	CP-EBF-DW-48	48"	120V-1PH-10A	1300	325 LBS.
CP-EBF-60	60"	120V-1PH-10A	1500	350 LBS.	CP-EBF-DW-60	60"	120V-1PH-10A	1500	350 LBS.
CP-EBF-72	72"	120V-1PH-10A	1700	400 LBS.	CP-EBF-DW-72	72"	120V-1PH-10A	1700	400 LBS.

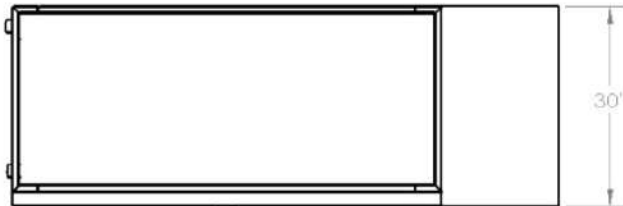

NOTE: THE NUMBER AND SIZE OF DRAWERS OR DOORS CHANGE WITH THE UNIT SIZE. ACTUAL DIMENSIONS WILL BE FINALIZED IN THE APPROVAL DRAWINGS.

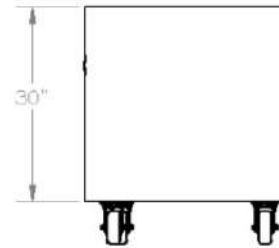
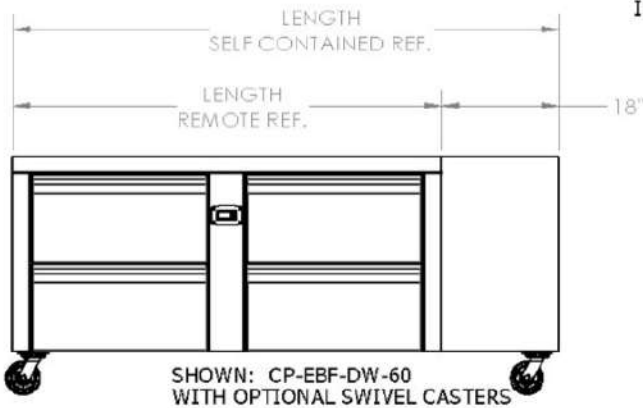

INSTALLATION INSTRUCTIONS

1. Observe all local and national codes.
2. This appliance is manufactured for commercial use ONLY. It is NOT intended for residential indoor use.
3. We upgrade our products regularly and in doing so, materials, specifications, and model numbers are subject to change without notice.

CHAR Products, LLC

Ph. 702-489-9888
Fax. 702-489-9898

2

Website: www.charprd.com
Email: info@charprd.com

2915 Losee Rd. Ste 106
N. Las Vegas, NV 89030

Printed in USA—Jan. 2020

© copyright 2020



ITEM NO	
QUANTITY	
JOB NAME	
JOB NO	

DROP-IN FREEZER PAN

SPECIFICATION SHEET



CP-FI-2424

AVAILABLE MODELS

CP-FI-2424

STANDARD FEATURES

- 14 gauge stainless pan
- Internally insulated pan
- Easy on/off switch
- Self-contained refrigeration unit
- Remote defrost foot pedal switch
- Cleanout tray
- Two year warranty: parts and labor

SPECIFICATIONS

Self contained, refrigerated, drop-in frost top with cleanout tray. Uniform frost pattern allows utilization of entire pan surface. The manually operated defrost foot pedal allows operator full temperature control of the frost pan and full release of product. Pan and cleanout tray assembly is made of heavy duty brushed finish stainless steel.



CONSULTANT APPROVAL: _____

NOTES: _____

DATE: _____

CHAR Products, LLC	Ph. 702-489-9888 Fax. 702-489-9898	1	Website: www.charprd.com Email: info@charprd.com	2915 Looe Rd. Ste 106 N. Las Vegas, NV 89030
---------------------------	---------------------------------------	---	--	---

Printed in USA—Jan. 2020

© copyright 2020



MODEL #	LENGTH	WIDTH	ELECTRIC	BTU H	SHIPPING WEIGHT ESTIMATED
CP-FI-2424	28"	28"	120V-1PH-11A	10.953	150 LBS.

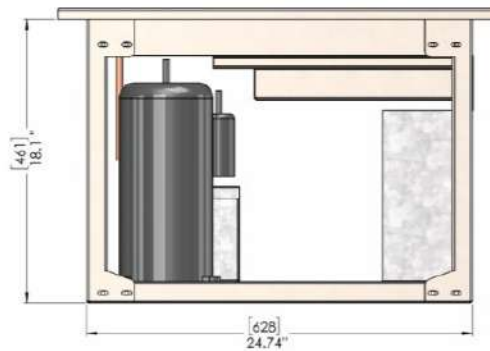
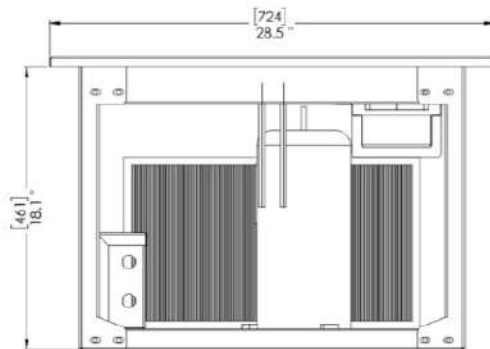
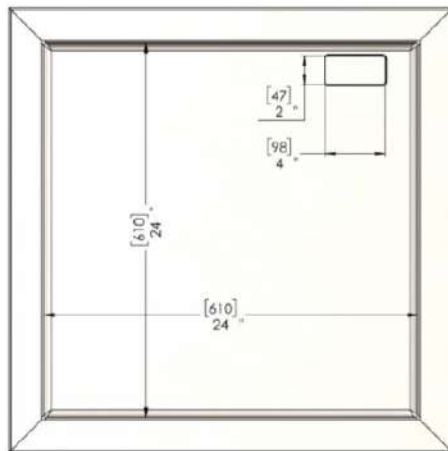

INSTALLATION INSTRUCTIONS

1. Observe all local and national codes.
2. This appliance is manufactured for commercial use ONLY. It is NOT intended for residential indoor use.
3. We upgrade our products regularly and in doing so, materials, specifications, and model numbers are subject to change without notice.

CHAR Products, LLC

Ph. 702-489-9888
Fax. 702-489-9898

2

Website: www.charprd.com
Email: info@charprd.com

2915 Losee R.d. Ste 106
N. Las Vegas, NV 89030

Printed in USA—Jan. 2020

© copyright 2020



Hot

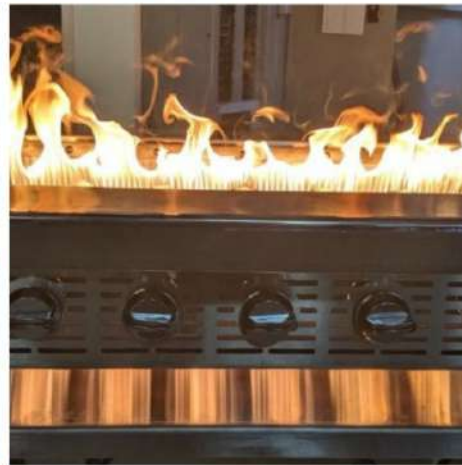

CHAR[®] Products can produce a wide range of cooking appliances:
Exhibition cooking, Wood-Fired cooking and Gas Fired
cooking appliances.



ITEM NO	
QUANTITY	
JOB NAME	
JOB NO	

BARREL ROASTING OVEN

SPECIFICATION SHEET

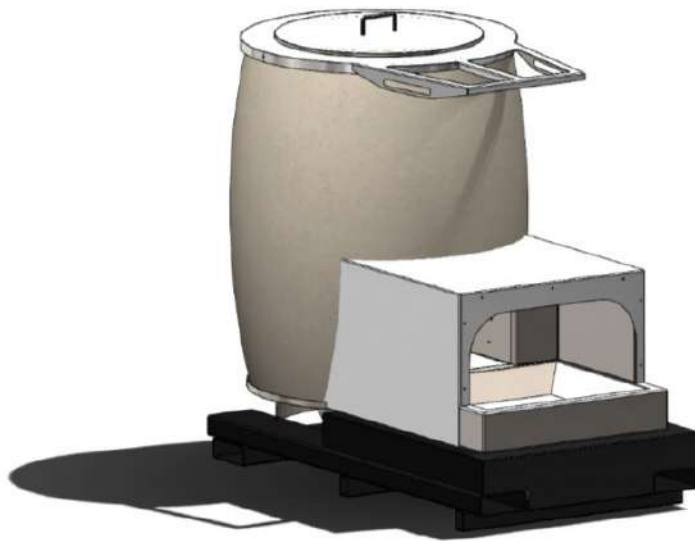

CP-BRO

AVAILABLE MODELS

CP-BRO

STANDARD FEATURES

- Heavy duty stainless steel components
- Cast ceramic oven chamber and fire box
- Fully welded stainless steel fire box enclosure
- Heavy duty base frame
- Removable cooking grate and oven lid
- Grease drain (grease trap to be provided by others)
- Two year warranty: parts and labor

SPECIFICATIONS

The CHAR® Barrel Roasting Oven is a solid fuel, cast ceramic oven. The ceramic vessel insulates the exterior from extreme temperatures, while maintaining an ideal internal cooking temperature. The top opening of the ceramic cooking chamber has a 25.72" opening. This allows access for hanging or grilling food items. The outside of this chamber is insulated and covered with an expanded metal mesh which functions as an attachment point for a stucco or tile finish (to be provided by others). The unit is mounted on a heavy duty frame designed for forklift mobility and ease of installation.

CONSULTANT APPROVAL:

NOTES:

DATE:



CHAR Products, LLC	Ph. 702-489-9888 Fax. 702-489-9898	1	Website: www.charprd.com Email: info@charprd.com	2915 Loose Rd. Ste 106 N. Las Vegas, NV 89030
--------------------	---------------------------------------	---	---	--

Printed in USA—Jan. 2020

© copyright 2020



APPLIANCES WITH SOUL™

MODEL #	LENGTH	WIDTH	SHIPPING WEIGHT ESTIMATED
CP-BRO	42"	71"	2200 LBS.

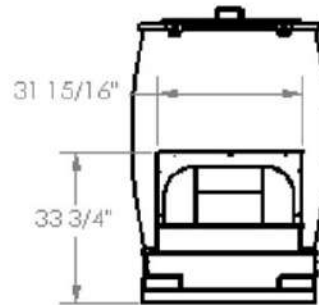
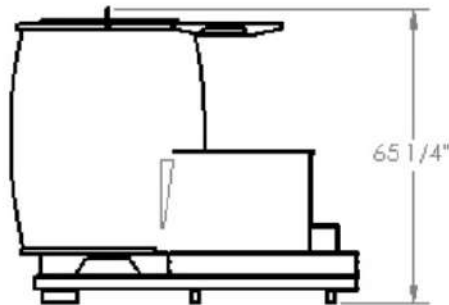
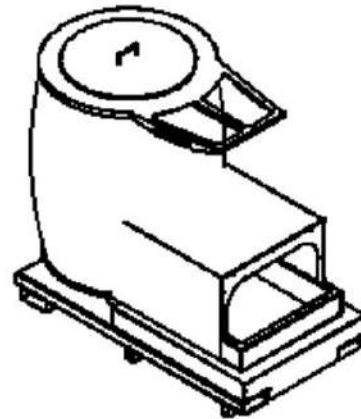
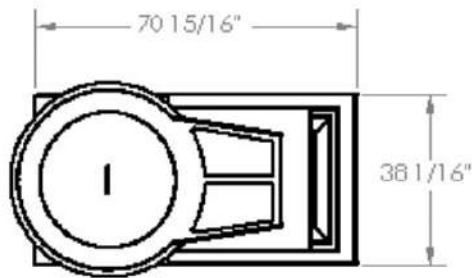

INSTALLATION INSTRUCTIONS

1. An adequate ventilation system is required for commercial use. DO NOT ATTEMPT TO OPERATE THIS EQUIPMENT WITHOUT IT.
2. Observe all local and national codes.
3. This appliance is manufactured for commercial use ONLY. It is NOT intended for residential indoor use.
4. We upgrade our products regularly and in doing so, materials, specifications, and model numbers are subject to change without notice.

CHAR Products, LLC

Ph. 702-489-9888
Fax. 702-489-9898

2

Website: www.charprd.com
Email: info@charprd.com

2915 Lo see Rd. Ste 106
N. Las Vegas, NV 89030

Printed in USA—Jan. 2020

© copyright 2020



ITEM NO	
QUANTITY	
JOB NAME	
JOB NO	

CHURRASCO COUNTER TOP GAS FUEL

SPECIFICATION SHEET

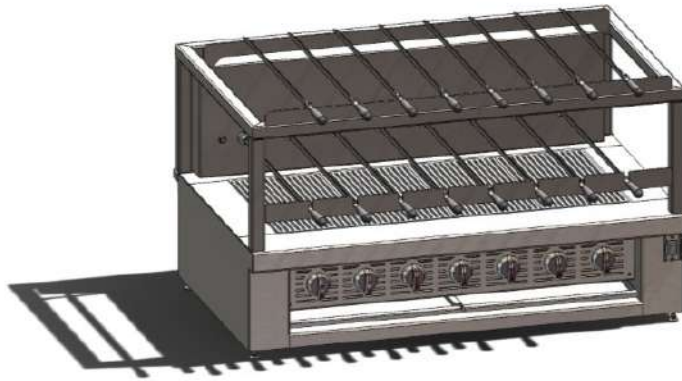

48" MODEL CP-CHU-CT-GS-48

SPECIFICATIONS

The gas fueled CHAR® Churrasco Broiler is available in single tier configurations in four accommodating sizes: 36", 48", 60", and 72". Each comes with rotating spits. A proven industrial gear motor offers years of uninterrupted operation of the rotating spits. To ensure performance and longevity, these units are constructed entirely of 304 stainless steel and have a ceramic cloth insulated exterior.

** TYPE OF GAS MUST BE SPECIFIED **



AVAILABLE MODELS

- CP-CHU-CT-GS-36
- CP-CHU-CT-GS-48
- CP-CHU-CT-GS-60
- CP-CHU-CT-GS-72

STANDARD FEATURES

- 14 gauge stainless steel body
- Ceramic cloth insulated body
- Multiple gas control valves for precise heat control
- Removable drip pans
- Overhead resting rack
- Fully welded 14 gauge stainless steel fire box
- 1/2" Thick laser cut removable steel grates
- Skewers included
- 3/4" Gas connection
- Adjustable leveling feet
- Cast iron burners
- Appropriate regulator for gas type selected
- Two year warranty: parts and labor

OPTIONS

- REMOVABLE 8" PLATE SHELF
- 3/4" GAS FLEX QUICK DISCONNECT
- STAINLESS STEEL GRATE QTY: _____
- FISH GRATES QTY: _____
- PLATE SHELF 1/6 PAN CONDIMENT INSERTS
- GRILL CLEANING KIT
- NATURAL GAS
- PROPANE
- GAS SAFETY

CONSULTANT APPROVAL: _____

NOTES: _____

DATE: _____

CHAR Products, LLC

Ph. 702-489-9888
Fax. 702-489-9898

1

Website: www.charprd.com
Email: info@charprd.com

2915 Loose R.d. Ste 106
N. Las Vegas, NV 89030

Printed in USA—Jan. 2020

© copyright 2020



APPLIANCES WITH SOUL™

MODEL #	LENGTH	FUEL LINE SIZE	ELECTRIC w/ gas safety	BTU INPUT –NG	SHIPPING WEIGHT ESTIMATED
CP-CHU-CT-GS-36	36"	3/4"	120V-1PH-10A	66,000	656 LBS.
CP-CHU-CT-GS-48	48"	3/4"	120V-1PH-10A	115,500	874 LBS.
CP-CHU-CT-GS-60	60"	3/4"	120V-1PH-10A	148,500	1,093 LBS.
CP-CHU-CT-GS-72	72"	3/4"	120V-1PH-10A	165,00	1,311 LBS.

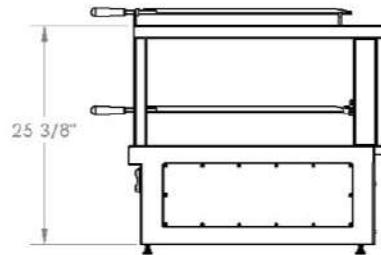
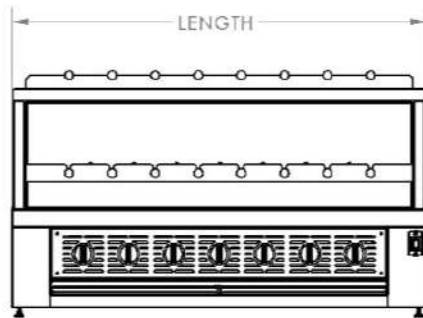
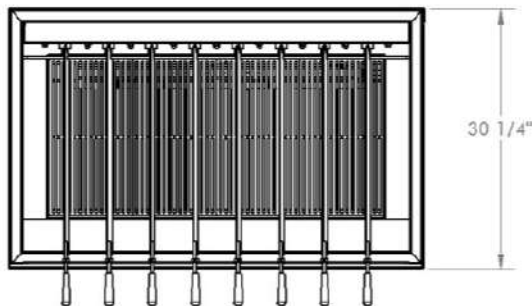

INSTALLATION INSTRUCTIONS

1. A properly sized gas line must be provided. All units are internally regulated. DO NOT DUAL REGULATE.
2. An adequate ventilation system is required for commercial use. DO NOT ATTEMPT TO OPERATE THIS EQUIPMENT WITHOUT IT.
3. Observe all local and national codes.
4. Proper combustion requires this unit to remain on casters or legs. If a curb installation is preferred, please contact CHAR Products for information in doing so.
5. This appliance is manufactured for commercial use ONLY. It is NOT intended for residential indoor use.
6. We upgrade our products regularly and in doing so, materials, specifications, and model numbers are subject to change without notice.

CHAR Products, LLC

Ph. 702-489-9888
Fax. 702-489-9898

2

Website: www.charprd.com
Email: info@charprd.com

2915 Losee Rd. Ste 106
N. Las Vegas, NV 89030

Printed in USA—Jan. 2020

© copyright 2020



ITEM NO	
QUANTITY	
JOB NAME	
JOB NO	

CHURRASCO COUNTER TOP SOLID FUEL SPECIFICATION SHEET

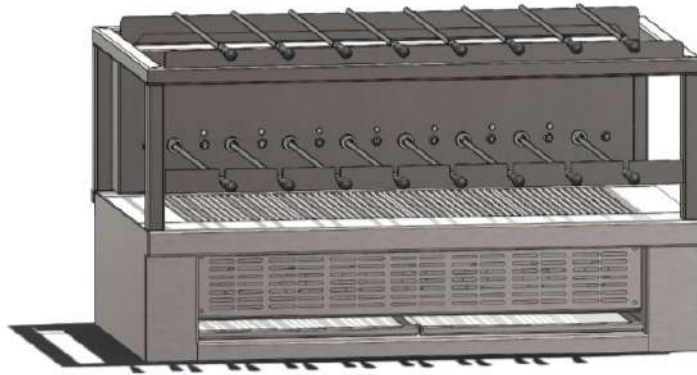

48" MODEL CP-CHU-CT-SF-48

AVAILABLE MODELS

<input type="checkbox"/> CP-CHU-CT-SF-36
<input type="checkbox"/> CP-CHU-CT-SF-48
<input type="checkbox"/> CP-CHU-CT-SF-60
<input type="checkbox"/> CP-CHU-CT-SF-72

STANDARD FEATURES

- 14 gauge stainless steel body
- Ceramic cloth insulated body
- Removable drip pans
- Overhead resting rack
- Fully welded 14 gauge stainless steel fire box
- 1/2" Thick laser cut removable steel grates
- Skewers included
- Adjustable leveling feet
- Two year warranty: parts and labor

SPECIFICATIONS

The solid fueled CHAR® Churrasco Broiler is available in single tier configurations in four accommodating sizes: 36", 48", 60", and 72". Each comes with rotating spits. A proven industrial gear motor offers years of uninterrupted operation of the rotating spits. To ensure performance and longevity, these units are constructed entirely of 304 stainless steel, have a ceramic cloth insulated exterior, and a ceramic brick lined cooking fire box.

OPTIONS

<input type="checkbox"/> REMOVABLE 8" PLATE SHELF
<input type="checkbox"/> STAINLESS STEEL GRATE QTY: _____
<input type="checkbox"/> FISH GRATES QTY: _____
<input type="checkbox"/> PLATE SHELF 1/6 PAN CONDIMENT INSERTS
<input type="checkbox"/> GRILL CLEANING KIT



CONSULTANT APPROVAL: _____
NOTES: _____
DATE: _____

CHAR Products, LLC	Ph. 702-489-9888 Fax. 702-489-9898	1	Website: www.charprd.com Email: info@charprd.com	2915 Loose Rd. Ste 106 N. Las Vegas, NV 89030
--------------------	---------------------------------------	---	---	--

Printed in USA—Jan. 2020

© copyright 2020



APPLIANCES WITH SOUL™

MODEL #	LENGTH	SHIPPING WEIGHT ESTIMATED
CP-CHU-CT-SF-36	36"	656 LBS.
CP-CHU-CT-SF-48	48"	874 LBS.
CP-CHU-CT-SF-60	60"	1,093 LBS.
CP-CHU-CT-SF72	72"	1,311 LBS.

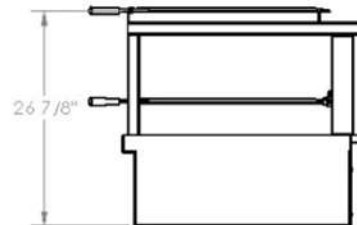
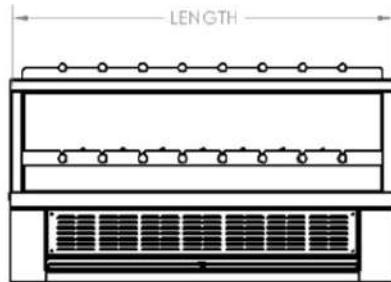
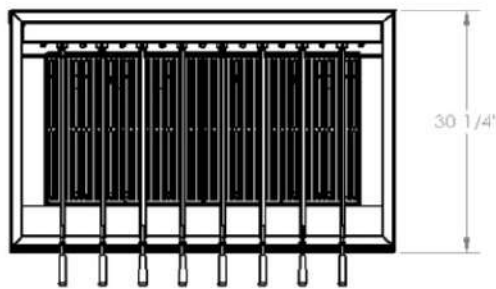

INSTALLATION INSTRUCTIONS

1. A properly sized gas line must be provided. All units are internally regulated. DO NOT DUAL REGULATE.
2. An adequate ventilation system is required for commercial use. DO NOT ATTEMPT TO OPERATE THIS EQUIPMENT WITHOUT IT.
3. Observe all local and national codes.
4. Proper combustion requires this unit to remain on casters or legs. If a curb installation is preferred, please contact CHAR Products for information in doing so.
5. This appliance is manufactured for commercial use ONLY. It is NOT intended for residential indoor use.
6. We upgrade our products regularly and in doing so, materials, specifications, and model numbers are subject to change without notice.

CHAR Products, LLC

Ph. 702-489-9888
Fax. 702-489-9898

2

Website: www.charprd.com
Email: info@charprd.com

2915 Losee Rd. Ste 106
N. Las Vegas, NV 89030

Printed in USA—Jan. 2020

© copyright 2020



ITEM NO	
QUANTITY	
JOB NAME	
JOB NO	

CHURRASCO FLOOR GAS FUEL

SPECIFICATION SHEET



**48" MODEL CP-CHU-FL-GS-48
WITH AMBIENT EQUIPMENT BASE AND
OPTIONAL SWIVEL CASTERS**

SPECIFICATIONS

The gas fueled CHAR® Churrasco Broiler is available in single tier configurations in four accommodating sizes: 36", 48", 60", and 72". Each comes with rotating spits. A proven industrial gear motor offers years of uninterrupted operation of the rotating spits. To ensure performance and longevity, these units are constructed entirely of 304 stainless steel and have a ceramic cloth insulated exterior.

** TYPE OF GAS MUST BE SPECIFIED **



AVAILABLE MODELS

- CP-CHU-FL-GS-36
- CP-CHU-FL-GS-48
- CP-CHU-FL-GS-60
- CP-CHU-FL-GS-72

STANDARD FEATURES

- 14 gauge stainless steel body
- Ceramic cloth insulated body
- Multiple gas control valves for precise heat control
- Removable drip pans
- Overhead resting rack
- Fully welded 14 gauge stainless steel fire box
- 1/2" Thick laser cut removable steel grates
- Skewers included
- 3/4" Gas connection
- Adjustable leveling feet
- Cast iron burners
- Appropriate regulator for gas type selected
- Two year warranty: parts and labor

OPTIONS

- REMOVABLE 8" PLATE SHELF
- 3/4" GAS FLEX QUICK DISCONNECT
- STAINLESS STEEL GRATE QTY: _____
- FISH GRATES QTY: _____
- PLATE SHELF 1/16 PAN CONDIMENT INSERTS
- EQUIPMENT BASE CABINET:
 - CP-EBA-CHU-XX AMBIENT MODEL
 - CP-EBR-CHU-XX REFRIGERATED MODEL
 - CP-EBF-CHU-XX FREEZER MODEL
- 6" CASTER KIT
- NATURAL GAS
- PROPANE
- GAS SAFETY

CONSULTANT APPROVAL: _____

NOTES: _____

DATE: _____

CHAR Products, LLC

Ph. 702-489-9888
Fax. 702-489-9898

1

Website: www.charprd.com
Email: info@charprd.com

2915 Losee Rd. Ste 106
N. Las Vegas, NV 89030

Printed in USA — Jan. 2020

© copyright 2020



MODEL #	LENGTH	FUEL LINE SIZE	ELECTRIC w/ gas safety	BTU INPUT –NG	SHIPPING WEIGHT ESTIMATED
CP-CHU-FL-GS-36	36"	3/4"	120V-1PH-10A	66,000	751 LBS.
CP-CHU-FL-GS-48	48"	3/4"	120V-1PH-10A	115,500	1,001 LBS.
CP-CHU-FL-GS-60	60"	3/4"	120V-1PH-10A	148,500	1,252 LBS.
CP-CHU-FL-GS-72	72"	3/4"	120V-1PH-10A	165,000	1,502 LBS.

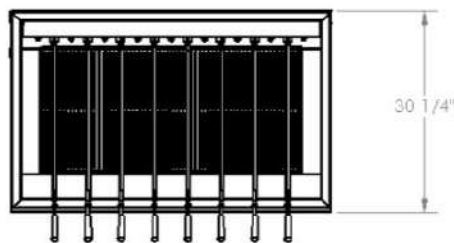

SHOWN: CP-CHU-FL-GS-48 WITH AMBIENT EQUIPMENT BASE CABINET AND OPTIONAL SWIVEL CASTERS

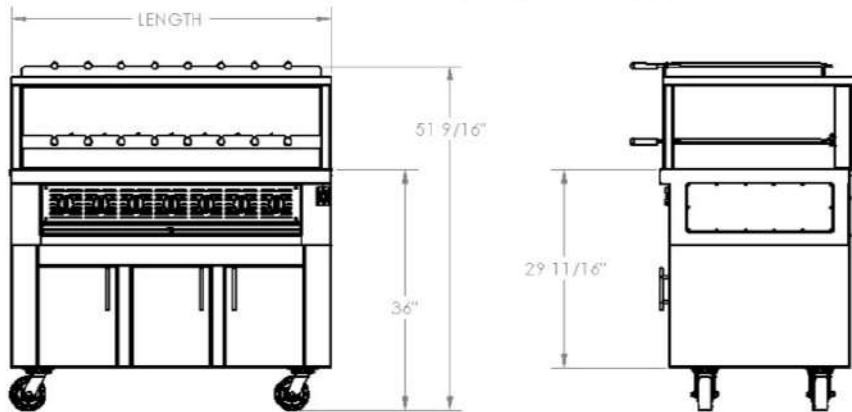

INSTALLATION INSTRUCTIONS

1. A properly sized gas line must be provided. All units are internally regulated. DO NOT DUAL REGULATE.
2. An adequate ventilation system is required for commercial use. DO NOT ATTEMPT TO OPERATE THIS EQUIPMENT WITHOUT IT.
3. Observe all local and national codes.
4. Proper combustion requires this unit to remain on casters or legs. If a curb installation is preferred, please contact CHAR Products for information in doing so.
5. This appliance is manufactured for commercial use ONLY. It is NOT intended for residential indoor use.
6. We upgrade our products regularly and in doing so, materials, specifications, and model numbers are subject to change without notice.

CHAR Products, LLC

Ph. 702-489-9888
Fax. 702-489-9398

2

Website: www.charprd.com 2915 Losee Rd. Ste 106
Email: info@charprd.com N. Las Vegas, NV 89030

Printed in USA — Jan. 2020

© copyright 2020



ITEM NO	
QUANTITY	
JOB NAME	
JOB NO	

CHURRASCO FLOOR SOLID FUEL

SPECIFICATION SHEET

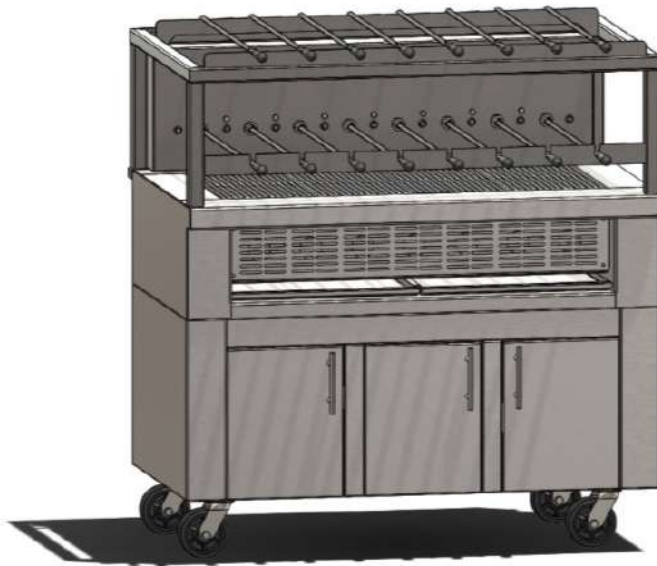

48" MODEL CP-CHU-FL-SF-48
SHOWN WITH OPTIONAL SWIVEL CASTERS

SPECIFICATIONS

The solid fueled CHAR® Churrasco Broiler is available in single tier configurations in four accommodating sizes: 36", 48", 60", and 72". Each comes with rotating spits. A proven industrial gear motor offers years of uninterrupted operation of the rotating spits. To ensure performance and longevity, these units are constructed entirely of 304 stainless steel, have a ceramic cloth insulated exterior, and a ceramic brick lined cooking interior.

AVAILABLE MODELS

- CP-CHU-FL-SF-36
- CP-CHU-FL-SF-48
- CP-CHU-FL-SF-60
- CP-CHU-FL-SF-72

STANDARD FEATURES

- 14 gauge stainless steel body
- Ceramic cloth insulated body
- Removable drip pans
- Overhead resting rack
- Fully welded 14 gauge stainless steel fire box
- 1/2" Thick laser cut removable steel grates
- Skewers included
- Adjustable leveling feet
- Two year warranty: parts and labor

OPTIONS

- REMOVABLE 8" PLATE SHELF
- STAINLESS STEEL GRATE QTY: _____
- FISH GRATES QTY: _____
- 6" CASTER KIT
- GRILL CLEANING KIT
- EQUIPMENT BASE CABINET:
 - CP-EBA-CHU-XX AMBIENT MODEL
 - CP-EBR-CHU-XX REFRIGERATED MODEL
 - CP-EBF-CHU-XX FREEZER MODEL

CONSULTANT APPROVAL:

NOTES:

DATE:



CHAR Products, LLC

Ph. 702-489-9888
Fax. 702-489-9898

1

Website: www.charprd.com
Email: info@charprd.com

2915 Loose Rd. Ste 106
N. Las Vegas, NV 89030

Printed in USA—Jan. 2020

© copyright 2020



APPLIANCES WITH SOUL™

MODEL #	LENGTH	SHIPPING WEIGHT ESTIMATED
CP-CHU-FL-SF-36	36"	751 LBS.
CP-CHU-FL-SF-48	48"	1,001 LBS.
CP-CHU-FL-SF-60	60"	1,252 LBS.
CP-CHU-FL-SF-72	72"	1,502 LBS.

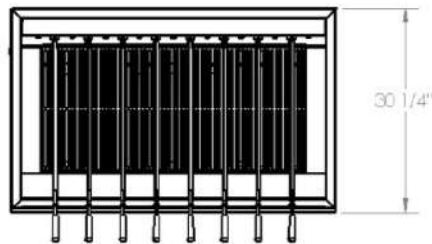

SHOWN: CP-CHU-FL-SF-48
WITH OPTIONAL SWIVEL CASTERS

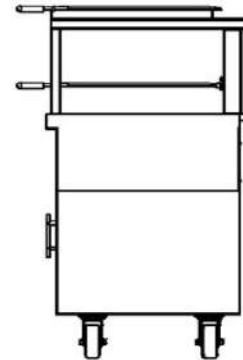
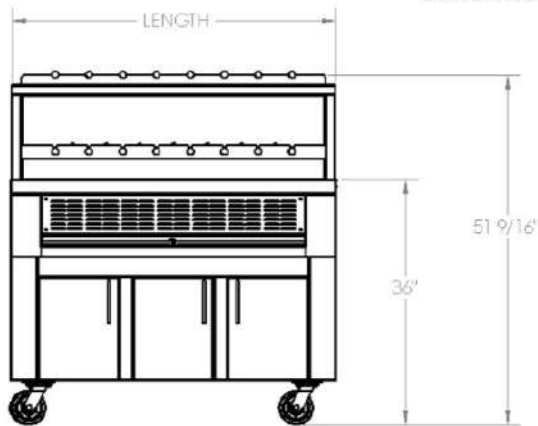

INSTALLATION INSTRUCTIONS

1. A properly sized gas line must be provided. All units are internally regulated. DO NOT DUAL REGULATE.
2. An adequate ventilation system is required for commercial use. DO NOT ATTEMPT TO OPERATE THIS EQUIPMENT WITHOUT IT.
3. Observe all local and national codes.
4. Proper combustion requires this unit to remain on casters or legs. If a curb installation is preferred, please contact CHAR Products for information in doing so.
5. This appliance is manufactured for commercial use ONLY. It is NOT intended for residential indoor use.
6. We upgrade our products regularly and in doing so, materials, specifications, and model numbers are subject to change without notice.

CHAR Products, LLC

Ph. 702-489-9888
Fax. 702-489-9898

2

Website: www.charprd.com
Email: info@charprd.com

2915 Losee Rd. Ste 106
N. Las Vegas, NV 89030

Printed in USA—Jan. 2020

© copyright 2020



ITEM NO	
QUANTITY	
JOB NAME	
JOB NO	

PAELLA GRILL SOLID FUEL

SPECIFICATION SHEET



CP-PAE-SF-120

SPECIFICATIONS

The CHAR® Paella Grill enables versatile direct and radiant heat in a solid fuel grilling station. Available in 48", 72", 96", and 120" round sizes, there is a size for every kitchen. This unit can serve as a single grill or multi-station grill to be operated by a single chef or multiple chefs, based upon your needs and requirements. The units are constructed with 304 stainless steel with a ceramic insulated exterior and refractory stone cooking surface. The ash collection cart allows for quick clean up during your cooking processes and for easy disposal of ash after hours.

AVAILABLE MODELS

- CP-PAE-SF-48
- CP-PAE-SF-72
- CP-PAE-SF-96
- CP-PAE-SF-120

STANDARD FEATURES

- Stainless steel construction
- Refractory stone surface
- Protective radius slide gates
- Working shelves with skewer rod holders
- Paella rings
- Stainless steel wood storage cabinets
- Ceramic insulation on floor and outer perimeter
- 6" Tall curb base ready for tile
- Ash collection cart
- Two year warranty: parts and labor

OPTIONS

- 6" CASTERS (48" AND 72" MODELS ONLY)
- VARIOUS FINISHES (CONSULT CHAR FOR OPTIONS)
- EXTRA SHELF W/ROD HOLDER QTY: _____
- EXTRA PAELLA RING QTY: _____
- CUSTOM SERVICE CART
- PAELLA PAN RACK
- PAELLA PAN

CONSULTANT APPROVAL: _____	
NOTES: _____	
DATE: _____	



CHAR Products, LLC

Ph. 702-489-9888
Fax. 702-489-9898

Website: www.charprd.com
Email: info@charprd.com

2915 Loose R.d. Ste 106
N. Las Vegas, NV 89030



APPLIANCES WITH SOUL™

MODEL #	SIZE A	# of STATIONS	SHIPPING WEIGHT ESTIMATED
CP-PAE-SF-48	48"	3	3850 LBS.
CP-PAE-SF-72	72"	4	4050 LBS.
CP-PAE-SF-96	96"	5	4975 LBS.
CP-PAE-SF-120	120"	6	5525 LBS.

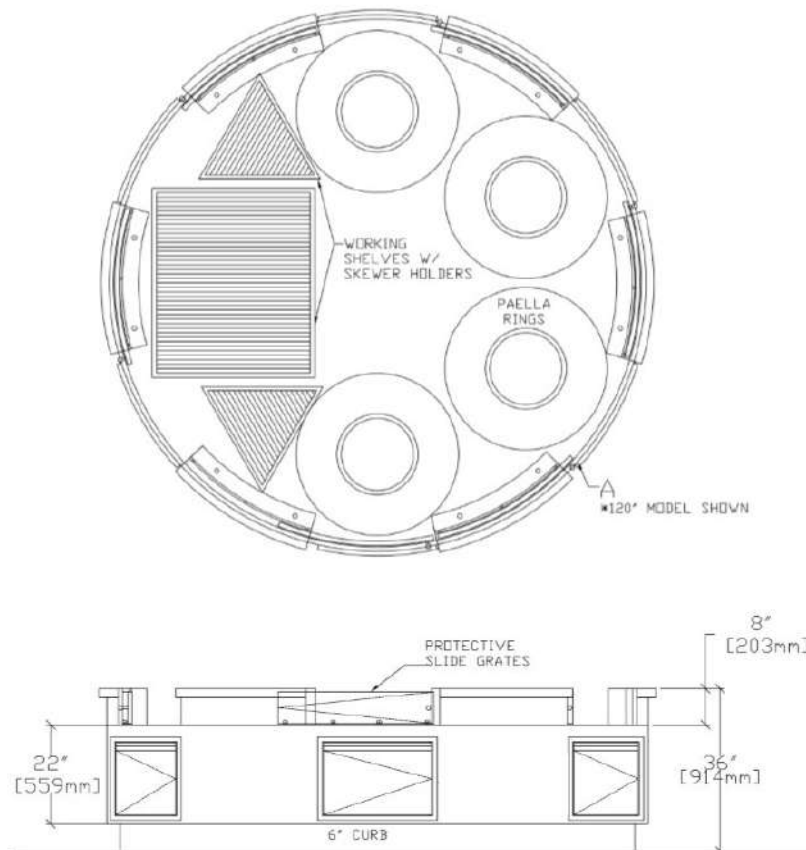

INSTALLATION INSTRUCTIONS

1. A properly sized gas line must be provided. All units are internally regulated. DO NOT DUAL REGULATE.
2. An adequate ventilation system is required for commercial use. DO NOT ATTEMPT TO OPERATE THIS EQUIPMENT WITHOUT IT.
3. Observe all local and national codes.
4. This appliance is manufactured for commercial use ONLY. It is NOT intended for residential indoor use.
5. We upgrade our products regularly and in doing so, materials, specifications, and model numbers are subject to change without notice.

CHAR Products, LLC

Ph. 702-489-9888
Fax. 702-489-9898

2

Website: www.charprd.com
Email: info@charprd.com

2915 Losee Rd. Ste 106
N. Las Vegas, NV 89030

Printed in USA—Jan. 2020

© copyright 2020



ITEM NO	
QUANTITY	
JOB NAME	
JOB NO	

PRIMROSE GRILL SOLID FUEL

SPECIFICATION SHEET



CP-PRM-SF-96 WITH OPTIONAL BASE CABINET
AND ROTISSERIE OPTIONS

AVAILABLE MODELS

- CP-PRM-SF-48
- CP-PRM-SF-60
- CP-PRM-SF-72
- CP-PRM-SF-96
- CP-PRM-SF-120

STANDARD FEATURES

- Stainless steel construction
- Fire brick lined fire box
- Multi-level grates
- Stainless steel wood storage cabinets
- Ceramic insulation on floor and outer perimeter
- Optional exterior finishes available
- 6" Tall adjustable legs
- Two years parts and labor warranty

OPTIONS

- ROTISSERIE
- V-SHAPE STYLE GRILL GRATE RACK
QTY: _____
- GRIDDLE PLATE RACK QTY: _____
- OVERHEAD GANTRY
- UNDER-COUNTER GANTRY
- PLATE SHELF (SOLID)
- PLATE SHELF WITH CONDIMENT PAN CUT-OUTS
- 6" SWIVEL CASTERS (TWO LOCKING)
- CURB MOUNTED
- REFRIGERATED BASE
- DECORATIVE EXTERIOR

SPECIFICATIONS

The CHAR® solid fuel Primrose Grill is manufactured to precise standards using 304 stainless steel full body construction and heavy duty support framing. Operator safety and comfort is strengthened through the use of ceramic lined exterior panels that prevent heat transference. Enhanced cooking performance is achieved through the use of a refractory brick lined burn pit with tailgate style access for easy ash cleanout. The fully enclosed stainless steel wood storage area offers an easy solution for safely storing and adding your preferred solid fuel. The singular gantry system provides the clearance necessary to operate optional rotisserie attachments. Also, available are three interchangeable and unique grill racks that provide versatility in grill method and needs.



CONSULTANT APPROVAL: _____

NOTES: _____

DATE: _____

CHAR Products, LLC Ph. 702-489-9888 Fax. 702-489-9898	1	Website: www.charprd.com Email: info@charprd.com	2915 Leese Rd. Ste 106 N. Las Vegas, NV 89030
--	---	---	--

Printed in USA—Jan. 2020

© copyright 2020



APPLIANCES WITH SOUL™

MODEL #	LENGTH	ELECTRIC For ROTISSERIE	SHIPPING WEIGHT ESTIMATED
CP-PRM-SF-48	48"	120V-1PH-15A	950 LBS.
CP-PRM-SF-60	60"	120V-1PH-15A	1100 LBS.
CP-PRM-SF-72	72"	120V-1PH-15A	1500 LBS.
CP-PRM-SF-96	96"	120V-1PH-15A	1850 LBS.
CP-PRM-SF-120	120"	120V-1PH-15A	2250 LBS.

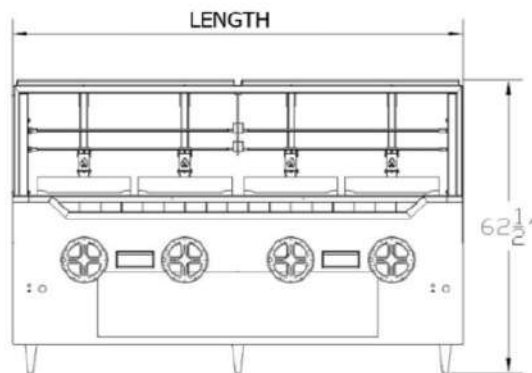
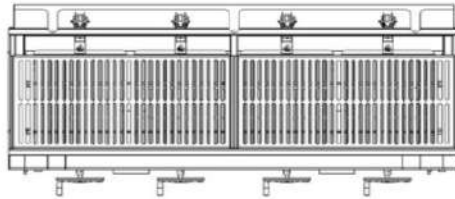

CP-PRM-SF-96 SHOWN WITH OPTIONAL ROTISSERIES



INSTALLATION INSTRUCTIONS

1. An adequate ventilation system is required for commercial use. DO NOT ATTEMPT TO OPERATE THIS EQUIPMENT WITHOUT IT.
2. Observe all local and national codes.
3. This appliance is manufactured for commercial use ONLY. It is NOT intended for residential indoor use.
4. We upgrade our products regularly and in doing so, materials, specifications, and model numbers are subject to change without notice.

CHAR Products, LLC

Ph. 702-489-9888
Fax. 702-489-9898

2

Website: www.charprd.com
Email: info@charprd.com

2915 Losee Rd. Ste 106
N Las Vegas, NV 89030

Printed in USA—Jan. 2020

© copyright 2020



ITEM NO	
QUANTITY	
JOB NAME	
JOB NO	

WAGON WHEEL GRILL SOLID FUEL

SPECIFICATION SHEET



CP-VVVG-SF-72
SHOWN WITH OPTIONAL ROTISSERIE W/ SKEWER

SPECIFICATIONS

The CHAR® solid fuel Wagon Wheel Grill has a wheel crank to raise and lower the grates. Currently available in 36", 48", 60", and 72". The Wagon Wheel Grill has an insulated exterior and a fire brick lined fire box. The unit has removable grilling grates, with options for laser cut stainless steel, "V" style, round rod style, or flat griddle plates. The lower section is for wood storage. The base model has a beautiful satin black powder coated finish. However, optional colors, including stainless steel, are available. Please contact a CHAR® representative for color options.

AVAILABLE MODELS

- CP-VVVG-SF-36
- CP-VVVG-SF-48
- CP-VVVG-SF-60
- CP-VVVG-SF-72

STANDARD FEATURES

- 1/4" thick powder coated steel body
- Ceramic insulated exterior surface
- 1/4" Steel welded steel fire box
- Fire brick lined
- 3/8" Thick laser cut removable steel grates
- Heavy duty 6" swivel casters (two locking)
- Two year warranty: parts and labor

OPTIONS

- 6" ADJUSTABLE LEGS
- 3/8" THICK POLISHED GRIDDLE PLATE
- STAINLESS STEEL LASER CUT GRATES
- V-STYLE GRATES
- ROUND ROD GRATES
- ROTISSERIE W/ SKEWER
- PAN CUT-OUTS
- ASH CART
- WOOD CART
- CUSTOM COLOR FINISH



CONSULTANT APPROVAL: _____

NOTES: _____

DATE: _____

CHAR Products, LLC

Ph. 702-489-9888
Fax. 702-489-9898

1

Website: www.charprd.com
Email: info@charprd.com

2915 Loose Rd. Ste 106
N. Las Vegas, NV 89030

Printed in USA—Jan. 2020

© copyright 2020



APPLIANCES WITH SOUL™

MODEL #	LENGTH	SHIPPING WEIGHT ESTIMATED
CP-WWG-SF-48	48"	950 LBS.
CP-WWG-SF-60	60"	1100 LBS.
CP-WWG-SF-72	72"	1500 LBS.
CP-WWG-SF-96	96"	1850 LBS.
CP-WWG-SF-120	120"	2250 LBS.

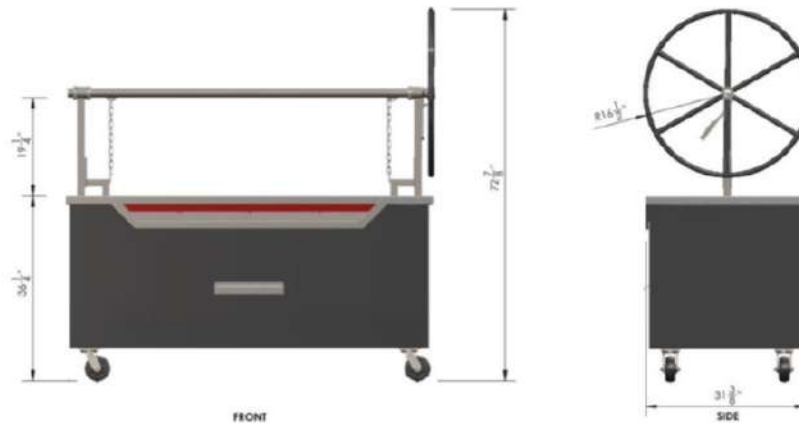
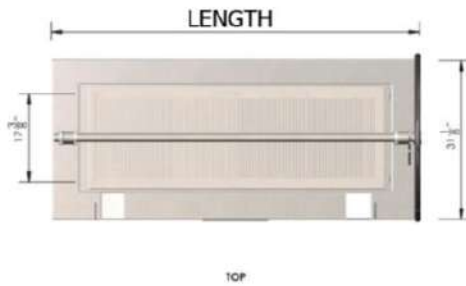

INSTALLATION INSTRUCTIONS	
<ol style="list-style-type: none"> 1. An adequate ventilation system is required for commercial use. DO NOT ATTEMPT TO OPERATE THIS EQUIPMENT WITHOUT IT. 2. Observe all local and national codes. 3. This appliance is manufactured for commercial use ONLY. It is NOT intended for residential indoor use. 4. We upgrade our products regularly and in doing so, materials, specifications, and model numbers are subject to change without notice. 	

CHAR Products, LLC	Ph. 702-489-9888 Fax. 702-489-9898	2	Website: www.charprd.com Email: info@charprd.com	2915 Losee R.d. Ste 106 N. Las Vegas, NV 89030
--------------------	---------------------------------------	---	---	---

Printed in USA—Jan. 2020 © copyright 2020



ITEM NO	
QUANTITY	
JOB NAME	
JOB NO	

PARILLA COUNTER TOP GAS FUEL

SPECIFICATION SHEET



CP-PAR-CT-GS-60

SPECIFICATIONS

The CHAR® Parilla Broiler is gas fueled and available in 4 accommodating sizes: 36", 48", 60", and 72". To ensure performance and longevity, these units are constructed entirely of 304 stainless steel and contain a ceramic insulated exterior. Full adjustability is offered in the independent adjustable grate system.

AVAILABLE MODELS

STANDARD MODEL	MODEL W/ FEATURE FLAME
<input type="checkbox"/> CP-PAR-CT-GS-36	<input type="checkbox"/> CP-PAR-CT-FF-36
<input type="checkbox"/> CP-PAR-CT-GS-48	<input type="checkbox"/> CP-PAR-CT-FF-48
<input type="checkbox"/> CP-PAR-CT-GS-60	<input type="checkbox"/> CP-PAR-CT-FF-60
<input type="checkbox"/> CP-PAR-CT-GS-72	<input type="checkbox"/> CP-PAR-CT-FF-72

STANDARD FEATURES

- 14 gauge stainless steel body
- Ceramic cloth insulated body
- Multiple gas control valves for precise heat control
- Removable drip pans
- Fully welded 14 gauge stainless steel fire box
- 1/2" Thick laser cut removable steel grates
- Adjustable leveling feet
- Cast iron burners
- 3/4" Gas connection
- Appropriate gas regulator (for gas type selected)
- Two year warranty: parts and labor

OPTIONS

- 3/4" GAS FLEX QUICK DISCONNECT
- STAINLESS STEEL GRATE QTY: _____
- 1/2" STAINLESS STEEL GRIDDLE PLATE QTY: _____
- GRILL CLEANING KIT
- NATURAL GAS
- PROPANE
- GAS SAFETY

** TYPE OF GAS MUST BE SPECIFIED **

CONSULTANT APPROVAL:

NOTES:

DATE:



CHAR Products, LLC

Ph. 702-489-9888
Fax. 702-489-9898

1

Website: www.charprd.com
Email: info@charprd.com

2915 Loose Rd. Ste 106
N. Las Vegas, NV 89030

Printed in USA—Jan. 2020

© copyright 2020



APPLIANCES WITH SOUL™

MODEL #	LENGTH	ELECTRIC w/ gas safety	BTU INPUT –NG	BTU W/ FEATURE FLAME	SHIPPING WEIGHT ESTIMATED
CP-PAR-CT-GS-36	36"	120V-1PH-10A	66,000	96,000	270 LBS.
CP-PAR-CT-GS-48	48"	120V-1PH-10A	115,500	145,500	370 LBS.
CP-PAR-CT-GS-60	60"	120V-1PH-10A	148,500	178,500	435 LBS.
CP-PAR-CT-GS-72	72"	120V-1PH-10A	165,000	195,000	510 LBS.

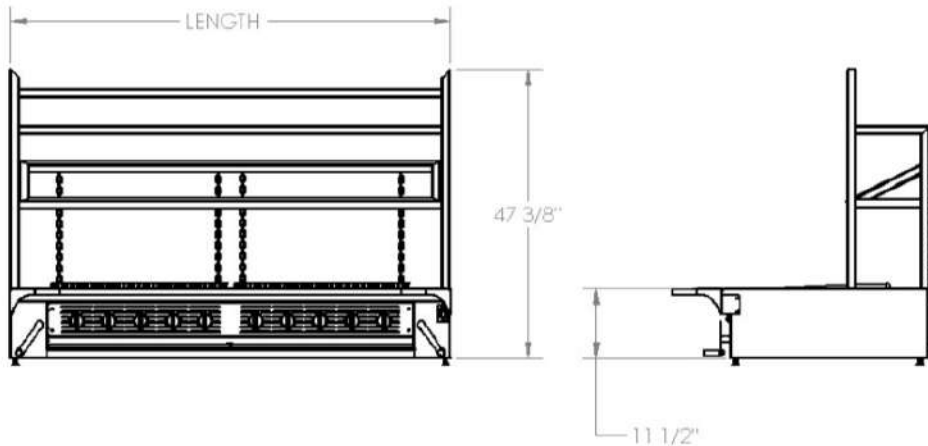
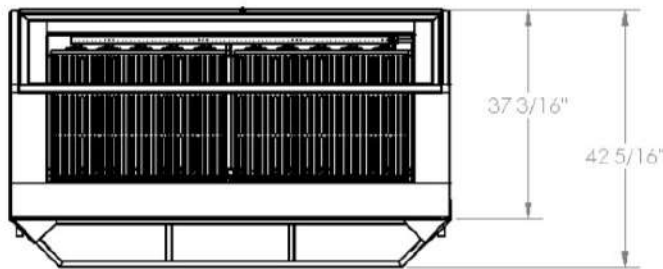

INSTALLATION INSTRUCTIONS

1. A properly sized gas line must be provided. All units are internally regulated. DO NOT DUAL REGULATE.
2. An adequate ventilation system is required for commercial use. DO NOT ATTEMPT TO OPERATE THIS EQUIPMENT WITHOUT IT.
3. Observe all local and national codes.
4. Proper combustion requires this unit to remain on casters or legs. If a curb installation is preferred, please contact CHAR Products for information in doing so.
5. This appliance is manufactured for commercial use ONLY. It is NOT intended for residential indoor use.
6. We upgrade our products regularly and in doing so, materials, specifications, and model numbers are subject to change without notice.

CHAR Products, LLC

Ph. 702-489-9888
Fax. 702-489-9898

2

Website: www.charprd.com
Email: info@charprd.com

2915 Losee Rd. Ste 106
N. Las Vegas, NV 89030

Printed in USA—Jan. 2020

© copyright 2020



ITEM NO	
QUANTITY	
JOB NAME	
JOB NO	

PARILLA COUNTER TOP SOLID FUEL

SPECIFICATION SHEET



72" MODEL CP-PAR-CT-SF-72

AVAILABLE MODELS

- CP-PAR-CT-SF-36
- CP-PAR-CT-SF-48
- CP-PAR-CT-SF-60
- CP-PAR-CT-SF-72

STANDARD FEATURES

- 14 gauge stainless steel body
- Ceramic cloth insulated body
- Removable drip pans
- Fully welded 14 gauge stainless steel fire box
- 1/2" Thick laser cut removable steel grates
- Adjustable leveling feet
- Grill cleaning kit
- Two year warranty: parts and labor

OPTIONS

- 1/2" STAINLESS STEEL GRATE QTY: _____
- 1/2" STAINLESS STEEL GRIDDLE PLATE QTY: _____
- GRILL CLEANING KIT

SPECIFICATIONS

The CHAR® Parilla Broiler is solid fueled and available in 4 accommodating sizes: 36", 48", 60", and 72". To ensure performance and longevity, these units are constructed entirely of 304 stainless steel, contain a ceramic cloth insulated exterior body, and a ceramic brick lined fire box. Full adjustability is offered in the independent adjustable cooking grate system.

CONSULTANT APPROVAL: _____

NOTES: _____

DATE: _____



CHAR Products, LLC	Ph. 702-489-9888 Fax. 702-489-9898	1	Website: www.charprd.com Email: info@charprd.com	2915 Loose Rd. Ste 106 N. Las Vegas, NV 89030
--------------------	---------------------------------------	---	---	--

Printed in USA—Jan. 2020

© copyright 2020



MODEL #	LENGTH	SHIPPING WEIGHT ESTIMATED
CP-PAR-CT-SF-36	36"	457 LBS.
CP-PAR-CT-SF-48	48"	610 LBS.
CP-PAR-CT-SF-60	60"	762 LBS.
CP-PAR-CT-SF-72	72"	914 LBS.

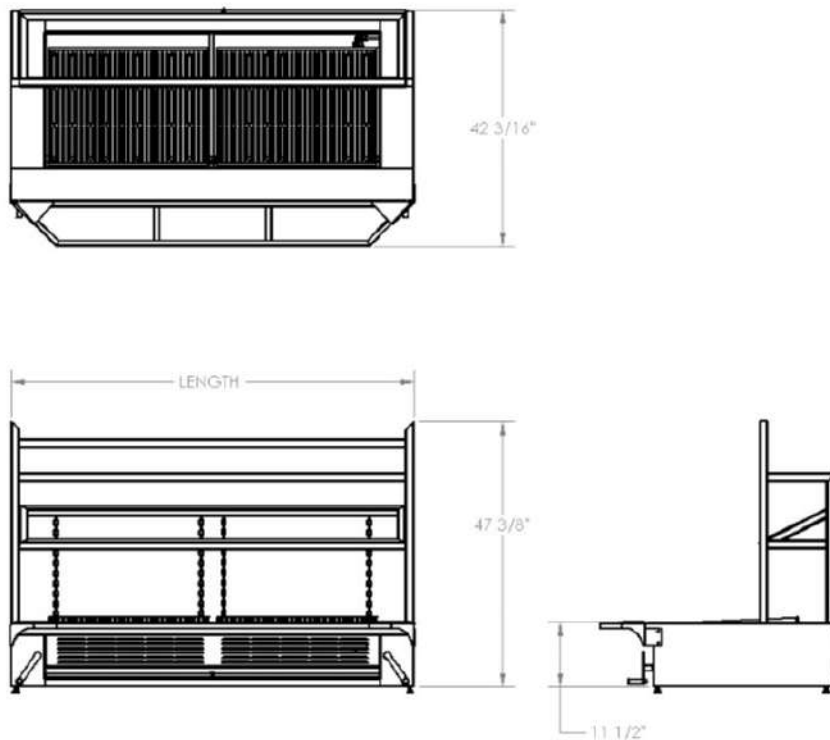

INSTALLATION INSTRUCTIONS	
<ol style="list-style-type: none"> 1. A properly sized gas line must be provided. All units are internally regulated. DO NOT DUAL REGULATE. 2. An adequate ventilation system is required for commercial use. DO NOT ATTEMPT TO OPERATE THIS EQUIPMENT WITHOUT IT. 3. Observe all local and national codes. 4. Proper combustion requires this unit to remain on casters or legs. If a curb installation is preferred, please contact CHAR products for information in doing so. 5. This appliance is manufactured for commercial use ONLY. It is NOT intended for residential indoor use. 6. We upgrade our products regularly and in doing so, materials, specifications, and model numbers are subject to change without notice. 	

CHAR Products, LLC	Ph. 702-489-9888 Fax. 702-489-9898	2	Website: www.charprd.com Email: info@charprd.com	2915 Losee Rd. Ste 106 N. Las Vegas, NV 89030
--------------------	---------------------------------------	---	---	--

Printed in USA—Jan. 2020 © copyright 2020



ITEM NO	
QUANTITY	
JOB NAME	
JOB NO	

PARILLA FLOOR GAS FUEL SPECIFICATION SHEET

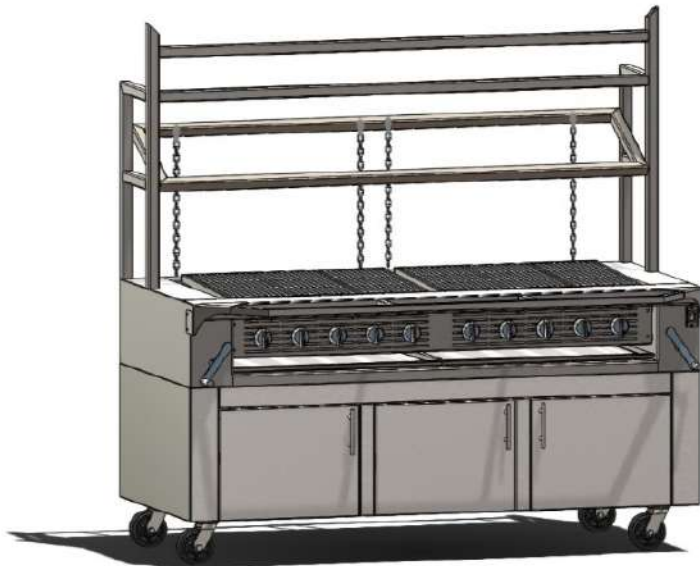

**72" MODEL CP-PAR-FL-GS-72
SHOWN WITH AMBIENT EQUIPMENT BASE CABINET
AND OPTIONAL SWIVEL CASTERS**

SPECIFICATIONS

The CHAR® Parilla Broiler is gas fueled and available in 4 accommodating sizes: 36", 48", 60", and 72". To ensure performance and longevity, these units are constructed entirely of 304 stainless steel and contain a ceramic insulated exterior. Full adjustability is offered in the independent adjustable grate system.

** TYPE OF GAS MUST BE SPECIFIED **



AVAILABLE MODELS

STANDARD MODEL	MODEL W/ FEATURE FLAME
<input type="checkbox"/> CP-PAR-FL-GS-36	<input type="checkbox"/> CP-PAR-FL-FF-36
<input type="checkbox"/> CP-PAR-FL-GS-48	<input type="checkbox"/> CP-PAR-FL-FF-48
<input type="checkbox"/> CP-PAR-FL-GS-60	<input type="checkbox"/> CP-PAR-FL-FF-60
<input type="checkbox"/> CP-PAR-FL-GS-72	<input type="checkbox"/> CP-PAR-FL-FF-72

STANDARD FEATURES

- 14 gauge stainless steel body
- Ceramic cloth insulated body
- Multiple gas control valves for precise heat control
- Removable drip pans
- Fully welded 14 gauge stainless steel fire box
- 1/2" Thick laser cut removable steel grates
- Adjustable leveling foot
- Cast iron burners
- 3/4" Gas connection
- Appropriate gas regulator (for gas type selected)
- Two year warranty: parts and labor

OPTIONS

- 3/4" GAS FLEX QUICK DISCONNECT
- 1/2" STAINLESS STEEL GRATE QTY: _____
- 1/2" STAINLESS STEEL GRIDDLE PLATE QTY: _____
- GRILL CLEANING KIT
- EQUIPMENT BASE CABINET:**
 - CP-EBA-CHU-XX AMBIENT MODEL
 - CP-EBR-CHU-XX REFRIGERATED MODEL
 - CP-EBF-CHU-XX FREEZER MODEL
- NATURAL GAS
- PROPANE
- GAS SAFETY

CONSULTANT APPROVAL: _____

NOTES: _____

DATE: _____

CHAR Products, LLC Ph. 702-489-9888
Fax. 702-489-9898

1

Website: www.charprd.com
Email: info@charprd.com

2915 Loose R.d. Ste 106
N. Las Vegas, NV 89030

Printed in USA—Jan. 2020

© copyright 2020



APPLIANCES WITH SOUL™

MODEL #	LENGTH	ELECTRIC w/ gas safety	BTU INPUT -NG	BTU W/ FEATURE FLAME	SHIPPING WEIGHT ESTIMATED
CP-PAR-FL-GS-36	36"	120V-1PH-10A	66,000	96,000	549 LBS.
CP-PAR-FL-GS-48	48"	120V-1PH-10A	115,500	145,500	732 LBS.
CP-PAR-FL-GS-60	60"	120V-1PH-10A	148,500	178,500	915 LBS.
CP-PAR-FL-GS-72	72"	120V-1PH-10A	165,000	195,000	1,097 LBS.

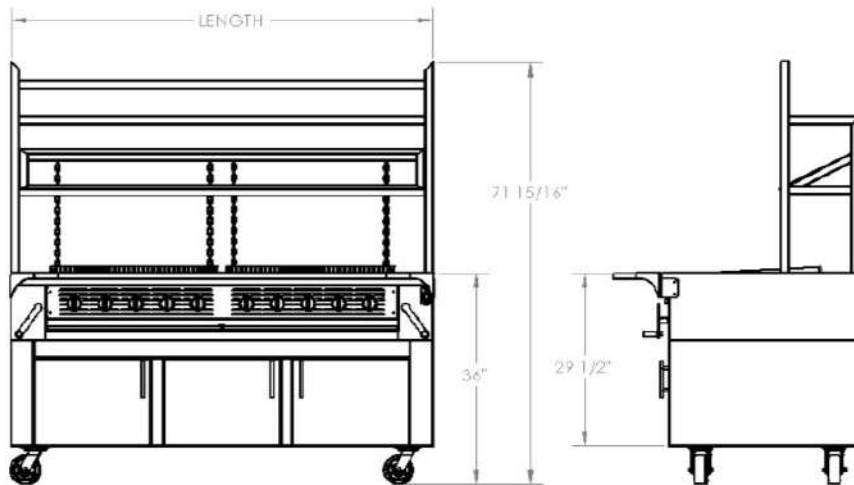
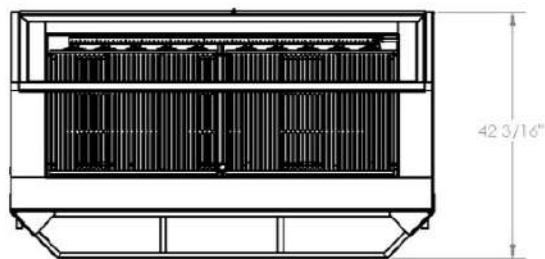

INSTALLATION INSTRUCTIONS

1. A properly sized gas line must be provided. All units are internally regulated. DO NOT DUAL REGULATE.
2. An adequate ventilation system is required for commercial use. DO NOT ATTEMPT TO OPERATE THIS EQUIPMENT WITHOUT IT.
3. Observe all local and national codes.
4. Proper combustion requires this unit to remain on casters or legs. If a curb installation is preferred, please contact CHAR Products for information in doing so.
5. This appliance is manufactured for commercial use ONLY. It is NOT intended for residential indoor use.
6. We upgrade our products regularly and in doing so, materials, specifications, and model numbers are subject to change without notice.

CHAR Products, LLC

Ph. 702-489-9888
Fax. 702-489-9898

2

Website: www.charprd.com
Email: info@charprd.com

2915 Losee Rd. Ste 106
N. Las Vegas, NV 89030

Printed in USA—Jan. 2020

© copyright 2020



ITEM NO	
QUANTITY	
JOB NAME	
JOB NO	

PARILLA FLOOR SOLID FUEL SPECIFICATION SHEET

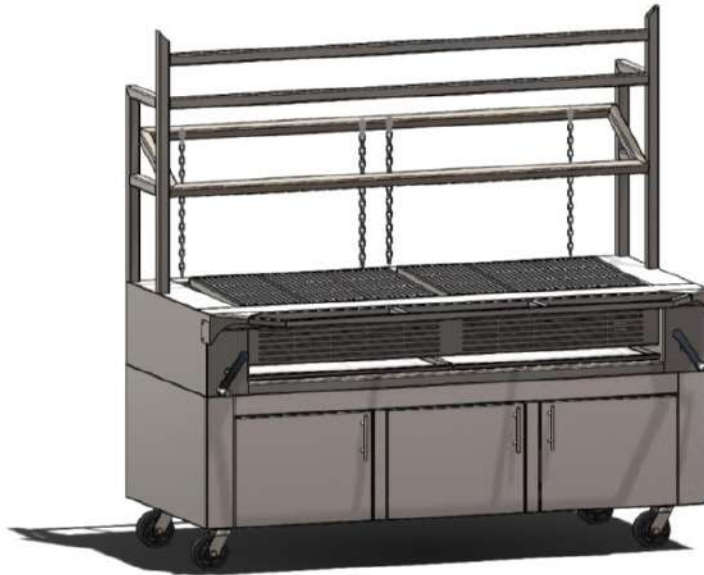

72" MODEL CP-PAR-FL-SF-72
SHOWN WITH AMBIENT EQUIPMENT BASE CABINET
AND OPTIONAL SWIVEL CASTERS

SPECIFICATIONS

The CHAR® Parilla Broiler is solid fueled and available in 4 accommodating sizes: 36", 48", 60", and 72". To ensure performance and longevity, these units are constructed entirely of 304 stainless steel, contain a ceramic cloth insulated exterior body, and a ceramic brick lined fire box. Full adjustability is offered in the independent adjustable cooking grate system.

AVAILABLE MODELS

- CP-PAR-FL-SF-36
- CP-PAR-FL-SF-48
- CP-PAR-FL-SF-60
- CP-PAR-FL-SF-72

STANDARD FEATURES

- 14 gauge stainless steel body
- Ceramic insulated
- Removable drip pans
- Fully welded 14 gauge stainless steel fire box
- Removable 1/2" stainless steel grates
- Adjustable leveling feet
- Grill cleaning kit
- Two year warranty: parts and labor

OPTIONS

- 1/2" STAINLESS STEEL GRATE QTY: _____
- 1/2" STAINLESS STEEL GRIDDLE PLATE QTY: _____
- GRILL CLEANING KIT
- HEAVY DUTY 6" SWIVEL CASTERS (TWO LOCKING)
- EQUIPMENT BASE CABINET:
 - CP-EBA-CHU-XX AMBIENT MODEL
 - CP-EBR-CHU-XX REFRIGERATED MODEL
 - CP-EBF-CHU-XX FREEZER MODEL

CONSULTANT APPROVAL: _____
NOTES: _____
DATE: _____



CHAR Products, LLC Ph. 702-489-9888
Fax. 702-489-9898

Website: www.charprd.com
Email: info@charprd.com

2915 Loose Rd. Ste 106
N. Las Vegas, NV 89030



MODEL #	LENGTH	SHIPPING WEIGHT ESTIMATED
CP-PAR-FL-SF-36	36"	549 LBS.
CP-PAR-FL-SF-48	48"	732 LBS.
CP-PAR-FL-SF-60	60"	915 LBS.
CP-PAR-FL-SF-72	72"	1097 LBS.

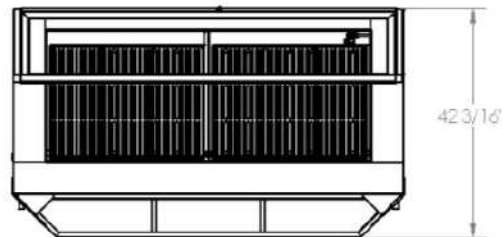

SHOWN: CP-PAR-CT-SF-72
WITH AMBIENT CABINET BASE AND
OPTIONAL SWIVEL CASTERS

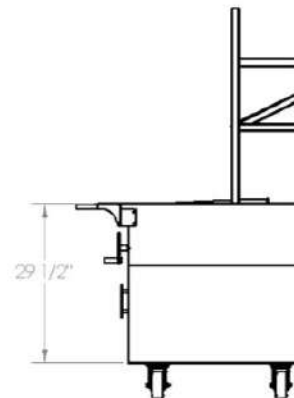
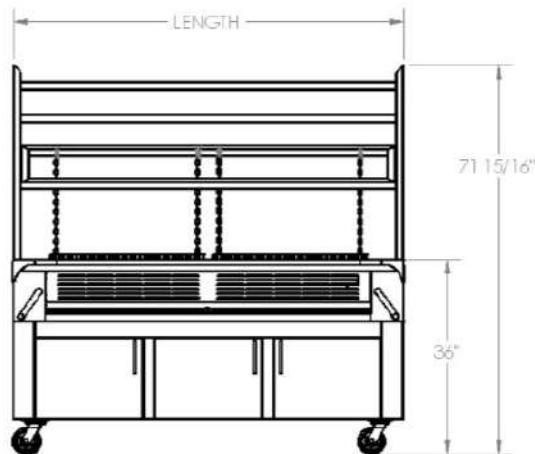

INSTALLATION INSTRUCTIONS

1. A properly sized gas line must be provided. All units are internally regulated. DO NOT DUAL REGULATE.
2. An adequate ventilation system is required for commercial use. DO NOT ATTEMPT TO OPERATE THIS EQUIPMENT WITHOUT IT.
3. Observe all local and national codes.
4. Proper combustion requires this unit to remain on casters or legs. If a curb installation is preferred please contact CHAR Products for information in doing so.
5. This appliance is manufactured for commercial use ONLY. It is NOT intended for residential indoor use.
6. We upgrade our products regularly and in doing so, materials, specifications, and model numbers are subject to change without notice.

CHAR Products, LLC

Ph. 702-489-9888
Fax. 702-489-9898

2

Website: www.charprd.com
Email: info@charprd.com

2915 Losee Rd. Ste 106
N. Las Vegas, NV 89030

Printed in USA—Jan. 2020

© copyright 2020



ITEM NO	
QUANTITY	
JOB NAME	
JOB NO	

ROBATA NARROW WIDTH GAS FUEL

SPECIFICATION SHEET



60" MODEL CP-ROBNW-GS-60

AVAILABLE MODELS

<input type="checkbox"/>	CP-ROBNW-GS-36
<input type="checkbox"/>	CP-ROBNW-GS-48
<input type="checkbox"/>	CP-ROBNW-GS-60
<input type="checkbox"/>	CP-ROBNW-GS-72

STANDARD FEATURES

- 14 gauge stainless steel body
- Ceramic cloth insulated exterior
- Removable cast iron burners
- Fully welded 14 gauge stainless steel fire box
- 1/2" Thick laser cut removable steel grates
- Adjustable leveling feet
- Grill cleaning kit
- Two year warranty: parts and labor

SPECIFICATIONS

This CHAR® Robata Grill is gas fueled and constructed of 304 stainless steel. Currently available in 36", 48", 60", and 72" lengths. Ceramic insulated exterior and heavy duty cast iron burners ensure performance and longevity of the grill.

OPTIONS

<input type="checkbox"/>	6" ADJUSTABLE LEGS
<input type="checkbox"/>	1/2" THICK GRIDDLE PLATE QTY: _____
<input type="checkbox"/>	DOUBLE-TIER RACK
<input type="checkbox"/>	NATURAL GAS
<input type="checkbox"/>	PROPANE
<input type="checkbox"/>	GAS SAFETY

** TYPE OF GAS MUST BE SPECIFIED **

CONSULTANT APPROVAL: _____

NOTES: _____

DATE: _____



CHAR Products, LLC Ph. 702-489-9888 Fax. 702-489-9898	1	Website: www.charprd.com Email: info@charprd.com	2915 Loose Rd. Ste 106 N. Las Vegas, NV 89030
--	---	---	--

Printed in USA—Jan. 2020

© copyright 2020



MODEL #	LENGTH	BTU INPUT -NG	SHIPPING WEIGHT ESTIMATED
CP-ROBNW-GS-36	36"	74,000	150 LBS.
CP-ROBNW-GS-48	48"	74,000	200 LBS.
CP-ROBNW-GS-60	60"	111,000	250 LBS.
CP-ROBNW-GS-72	72"	111,000	300 LBS.

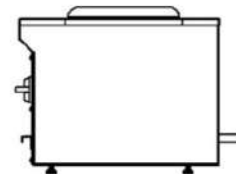
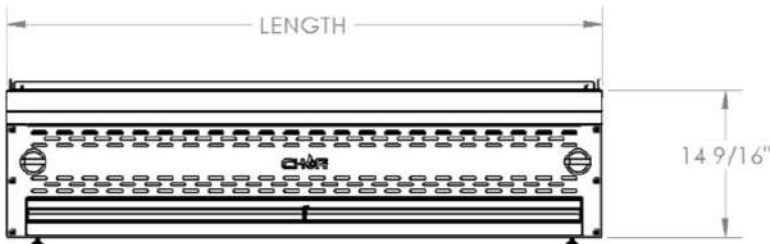
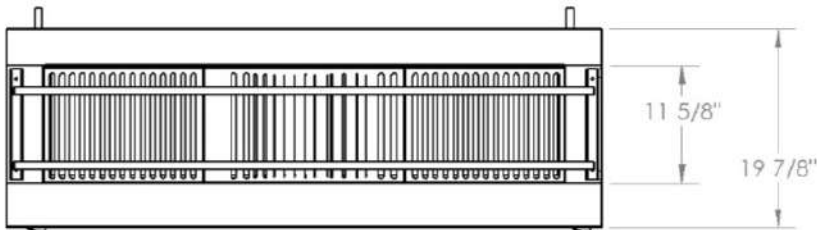

INSTALLATION INSTRUCTIONS

1. A properly sized gas line must be provided. All units are internally regulated. DO NOT DUAL REGULATE.
2. An adequate ventilation system is required for commercial use. DO NOT ATTEMPT TO OPERATE THIS EQUIPMENT WITHOUT IT.
3. Observe all local and national codes.
4. Proper combustion requires this unit to remain on casters or legs. If a curb installation is preferred, please contact CHAR Products for information in doing so.
5. This appliance is manufactured for commercial use ONLY. It is NOT intended for residential indoor use.
6. We upgrade our products regularly and in doing so materials, specifications, and model numbers are subject to change without notice.

CHAR Products, LLC

Ph. 702-489-9888
Fax. 702-489-9898

2

Website: www.charprd.com
Email: info@charprd.com

2915 Losee Rd. Ste 106
N. Las Vegas, NV 89030

Printed in USA—Jan. 2020

© copyright 2020



ITEM NO	
QUANTITY	
JOB NAME	
JOB NO	

ROBATA NARROW WIDTH SOLID FUEL SPECIFICATION SHEET



48" MODEL CP-ROBNW-SF-48

AVAILABLE MODELS

<input type="checkbox"/>	CP-ROBNW-SF-36
<input type="checkbox"/>	CP-ROBNW-SF-48
<input type="checkbox"/>	CP-ROBNW-SF-60
<input type="checkbox"/>	CP-ROBNW-SF-72

STANDARD FEATURES

- 14 gauge stainless steel body
- Ceramic cloth insulated exterior
- Fully welded 14 gauge stainless steel fire box
- Fire brick lined
- 1/2" Thick laser cut removable steel grates
- Adjustable leveling feet
- Grill cleaning kit
- Two year warranty: parts and labor

SPECIFICATIONS

This CHAR® Robata Grill is solid fueled and constructed of 304 stainless steel. Currently available in 36", 48", 60", and 72" lengths. Units have ceramic insulated exteriors. The quality of this grill will ensure performance and longevity.

OPTIONS

<input type="checkbox"/>	DOUBLE-TIER RACK
<input type="checkbox"/>	1/2" THICK STAINLESS STEEL GRATE QTY: _____
<input type="checkbox"/>	1/2" THICK STAINLESS STEEL GRIDDLE PLATE QTY: _____
<input type="checkbox"/>	GRILL CLEANING KIT

CONSULTANT APPROVAL: _____

NOTES: _____

DATE: _____



CHAR Products, LLC	Ph. 702-489-9888 Fax. 702-489-9898	1	Website: www.charpid.com Email: info@charpid.com	2915 Loose R.d. Ste 106 N. Las Vegas, NV 89030
--------------------	---------------------------------------	---	---	---

Printed in USA—Jan. 2020

© copyright 2020



MODEL #	LENGTH	SHIPPING WEIGHT ESTIMATED
CP-ROBNW-SF-36	36"	150 LBS.
CP-ROBNW-SF-48	48"	200 LBS.
CP-ROBNW-SF-60	60"	250 LBS.
CP-ROBNW-SF-72	72"	300 LBS.

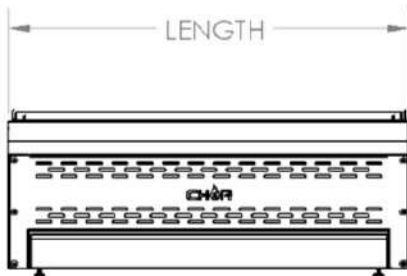
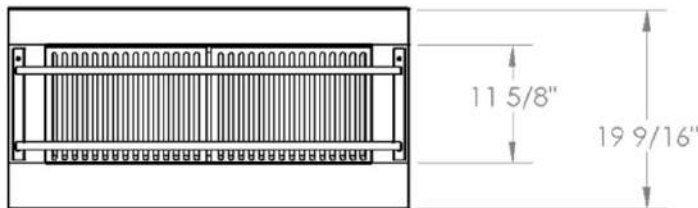

INSTALLATION INSTRUCTIONS

1. An adequate ventilation system is required for commercial use. DO NOT ATTEMPT TO OPERATE THIS EQUIPMENT WITHOUT IT.
2. Observe all local and national codes.
3. Proper combustion requires this unit to remain on casters or legs. If a curb installation is preferred, please contact CHAR Products for information in doing so.
4. This appliance is manufactured for commercial use ONLY. It is NOT intended for residential indoor use.
5. We upgrade our products regularly and in doing so, materials, specifications, and model numbers are subject to change without notice.

CHAR Products, LLC

Ph. 702-489-9888
Fax. 702-489-9898

2

Website: www.charprd.com
Email: info@charprd.com

2915 Losee Rd. Ste 106
N. Las Vegas, NV 89030

Printed in USA—Jan. 2020

© copyright 2020



ITEM NO	
QUANTITY	
JOB NAME	
JOB NO	

ROBATA STANDARD WIDTH COUNTER TOP GAS FUEL SPECIFICATION SHEET



60" MODEL CP-ROBSD-CT-GS-60
SHOWN WITH OPTIONAL DOUBLE TIER RACK

SPECIFICATIONS

The CHAR® Robata Grill is gas fueled and constructed of 304 stainless steel. Currently available in 36", 48", 60", and 72" lengths. Ceramic insulated exterior body and heavy duty cast iron burners ensure performance and longevity of the grill.

AVAILABLE MODELS

STANDARD MODEL	MODEL W/ FEATURE FLAME
<input type="checkbox"/> CP-ROBSD-CT-GS-36	<input type="checkbox"/> CP-ROBSD-CT-FF-36
<input type="checkbox"/> CP-ROBSD-CT-GS-48	<input type="checkbox"/> CP-ROBSD-CT-FF-48
<input type="checkbox"/> CP-ROBSD-CT-GS-60	<input type="checkbox"/> CP-ROBSD-CT-FF-60
<input type="checkbox"/> CP-ROBSD-CT-GS-72	<input type="checkbox"/> CP-ROBSD-CT-FF-72

STANDARD FEATURES

- 14 gauge stainless steel body
- Multiple gas control valves for precise heat control
- Removable drip tray
- Fully welded 14 gauge stainless steel fire box
- 1/2" Thick laser cut steel grates
- Adjustable leveling feet
- Removable cast iron burners
- Two year warranty: parts and labor

OPTIONS

- DOUBLE-TIER RACK
- 1/2" THICK STAINLESS STEEL GRATE
QTY: _____
- 1/2" THICK STAINLESS STEEL GRIDDLE
PLATE QTY: _____
- GRILL CLEANING KIT
- NATURAL GAS
- PROPANE
- GAS SAFETY

** TYPE OF GAS MUST BE SPECIFIED **

CONSULTANT APPROVAL
NOTES:
DATE:



CHAR Products, LLC

Ph. 702-489-9888
Fax. 702-489-9898

1

Website: www.charprd.com
Email: info@charprd.com

2915 Lowe Rd Ste 106
N. Las Vegas, NV 89030

Printed in USA—Jan. 2020

© copyright 2020



MODEL #	LENGTH	ELECTRIC w/ gas safety	BTU INPUT -NG	BTU WITH FEATURE FLAME	SHIPPING WEIGHT ESTIMATED
CP-ROBSD-CT-GS-36	36"	120V-1PH-10A	66,000	96,000	324 LBS.
CP-ROBSD-CT-GS-48	48"	120V-1PH-10A	115,500	145,500	432 LBS.
CP-ROBSD-CT-GS-60	60"	120V-1PH-10A	148,500	178,500	541 LBS.
CP-ROBSD-CT-GS-72	72"	120V-1PH-10A	165,000	195,000	648 LBS.

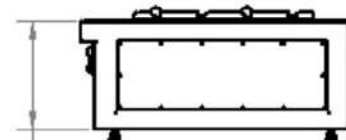
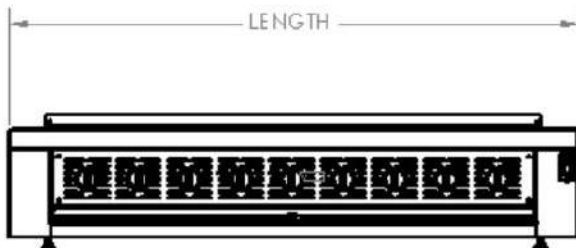

11 7/16"

INSTALLATION INSTRUCTIONS	
1.	A properly sized gas line must be provided. All units are internally regulated. DO NOT DUAL REGULATE.
2.	An adequate ventilation system is required for commercial use. DO NOT ATTEMPT TO OPERATE THIS EQUIPMENT WITHOUT IT.
3.	Observe all local and national codes.
4.	Proper combustion requires this unit to remain on casters or legs. If a curb installation is preferred, please contact CHAR Products for information in doing so.
5.	This appliance is manufactured for commercial use ONLY. It is NOT intended for residential indoor use.
6.	We upgrade our products regularly and in doing so, materials, specifications, and model numbers are subject to change without notice.

CHAR Products, LLC	Ph. 702-489-9888 Fax. 702-489-9898	2	Website: www.charprd.com Email: info@charprd.com	2915 Looxe Rd. Ste 106 N. Las Vegas, NV 89039
--------------------	---------------------------------------	---	---	--

Printed in USA—Jan. 2020

© copyright 2020



ITEM NO	
QUANTITY	
JOB NAME	
JOB NO	

ROBATA STANDARD WIDTH COUNTER TOP SOLID FUEL SPECIFICATION SHEET



60" MODEL CP-ROBSD-CT-SF-60

AVAILABLE MODELS

- CP-ROBSD-CT-SF-36
- CP-ROBSD-CT-SF-48
- CP-ROBSD-CT-SF-60
- CP-ROBSD-CT-SF-72

STANDARD FEATURES

- 14 gauge stainless steel body
- Ceramic cloth insulated exterior
- Fully welded 14 gauge stainless steel fire box
- Ceramic fire brick lined fire box
- 1/2" Thick laser cut removable steel grates
- Adjustable leveling feet
- Two year warranty: parts and labor

SPECIFICATIONS

This CHAR® Robata Grill is solid fueled and constructed of 304 stainless steel. Currently available in 36", 48", 60", and 72" lengths. Units have a ceramic insulated exterior and a ceramic brick lined fire box. The quality of this grill will ensure performance and longevity.

OPTIONS

- DOUBLE-TIER RACK
- 1/2" THICK STAINLESS STEEL GRATE
QTY: _____
- 1/2" THICK STAINLESS STEEL GRIDDLE
PLATE QTY: _____
- GRILL CLEANING KIT

CONSULTANT APPROVAL: _____

NOTES: _____

DATE: _____



CHAR Products, LLC Ph. 702-489-9888 Fax. 702-489-9898	1	Website: www.charprd.com Email: info@charprd.com	2915 Loose Rd. Ste 106 N. Las Vegas, NV 89030
--	---	--	--

Printed in USA—Jan. 2020

© copyright 2020



APPLIANCES WITH SOUL™

MODEL #	LENGTH	SHIPPING WEIGHT ESTIMATED
CP-ROBSD-CT-SF-36	36"	324 LBS.
CP-ROBSD-CT-SF-48	48"	432 LBS.
CP-ROBSD-CT-SF-60	60"	541 LBS.
CP-ROBSD-CT-SF-72	72"	648 LBS.

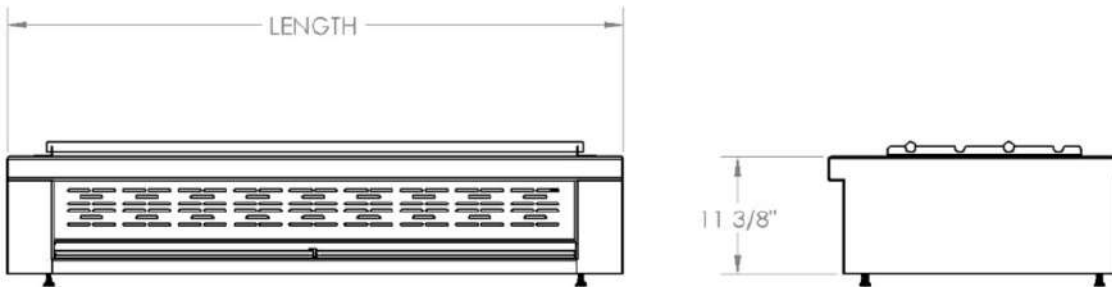
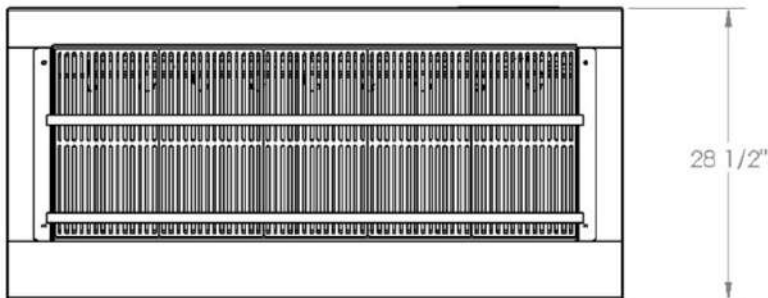

INSTALLATION INSTRUCTIONS

1. An adequate ventilation system is required for commercial use. DO NOT ATTEMPT TO OPERATE THIS EQUIPMENT WITHOUT IT.
2. Observe all local and national codes.
3. Proper combustion requires this unit to remain on casters or legs. If a curb installation is preferred, please contact CHAR Products for information in doing so.
4. This appliance is manufactured for commercial use ONLY. It is NOT intended for residential indoor use.
5. We upgrade our products regularly and in doing so, materials, specifications, and model numbers are subject to change without notice.

CHAR Products, LLC

Ph. 702-489-9888
Fax. 702-489-9898

2

Website: www.charprd.com
Email: info@charprd.com

2915 Losee Rd. Ste 106
N. Las Vegas, NV 89030

Printed in USA—Jan. 2020

© copyright 2020



ITEM NO	
QUANTITY	
JOB NAME	
JOB NO	

ROBATA STANDARD WIDTH FLOOR GAS FUEL SPECIFICATION SHEET

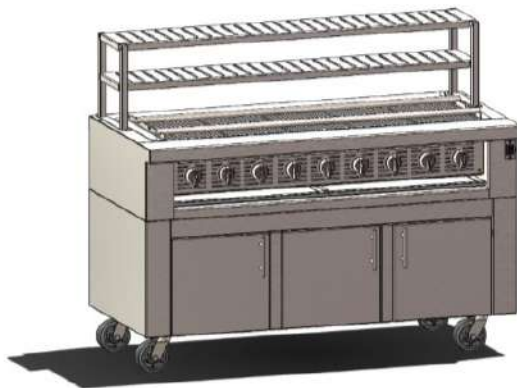

60" MODEL CP-ROBSD-FL-GS-60
SHOWN WITH AMBIENT EQUIPMENT BASE
CABINET AND OPTIONAL DOUBLE-TIER RACK

SPECIFICATIONS

The CHAR® Robata Grill is gas fueled and constructed of 304 stainless steel. Currently available in 36", 48", 60", and 72" lengths. Ceramic insulated exterior and heavy duty cast iron burners ensure performance and longevity of the grill.

** TYPE OF GAS MUST BE SPECIFIED **



AVAILABLE MODELS

STANDARD MODEL	MODEL W/ FEATURE FLAME
<input type="checkbox"/> CP-ROBSD-FL-GS-36	<input type="checkbox"/> CP-ROBSD-FL-FF-36
<input type="checkbox"/> CP-ROBSD-FL-GS-48	<input type="checkbox"/> CP-ROBSD-FL-FF-48
<input type="checkbox"/> CP-ROBSD-FL-GS-60	<input type="checkbox"/> CP-ROBSD-FL-FF-60
<input type="checkbox"/> CP-ROBSD-FL-GS-72	<input type="checkbox"/> CP-ROBSD-FL-FF-72

STANDARD FEATURES

- 14 gauge stainless steel body
- Multiple gas control valves for precise heat control
- Removable drip tray
- Fully welded 14 gauge stainless steel fire box
- 1/2" Thick laser cut steel grates
- Adjustable leveling feet
- Removable cast iron burners
- Two year warranty: parts and labor

OPTIONS

- DOUBLE-TIER RACK
- 1/2" THICK STAINLESS STEEL GRIDDLE PLATE
QTY: _____
- 1/2" THICK STAINLESS STEEL GRATES QTY: _____
- 6" SWIVEL CASTERS (TWO LOCKING)
- GRILL CLEANING KIT
- EQUIPMENT BASE CABINET:
 - CP-EBA-ROBSD-XX AMBIENT MODEL
 - CP-EBR-ROBSD-XX REFRIGERATED MODEL
 - CP-RBF-ROBSD-XX FREEZER MODEL
- NATURAL GAS
- PROPANE
- GAS SAFETY

CONSULTANT APPROVAL: _____

NOTES: _____

DATE: _____

CHAR Products, LLC Ph. 702-489-9888
Fax. 702-489-9898

Website: www.charprd.com 2915 Loose Rd. Ste 106
Email: info@charprd.com N. Las Vegas, NV 89030



MODEL #	LENGTH	ELECTRIC w/ gas safety	BTU INPUT –NG	BTU W/ FEATURE FLAME	SHIPPING WEIGHT ESTIMATED
CP-ROBSD-FL-GS-36	36"	120V-1PH-10A	66,000	96,000	444 LBS.
CP-ROBSD-FL-GS-48	48"	120V-1PH-10A	115,500	145,500	592 LBS.
CP-ROBSD-FL-GS-60	60"	120V-1PH-10A	148,500	178,500	740 LBS.
CP-ROBSD-FL-GS-72	72"	120V-1PH-10A	165,000	195,000	925 LBS.

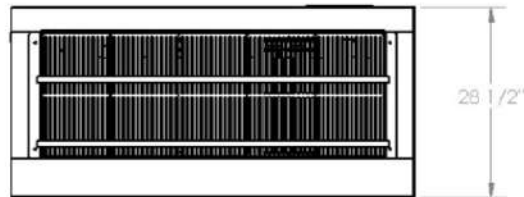

SHOWN: CP-ROBSD-FL-GS-60
WITH NO OPTIONS AND AMBIENT
CABINET.

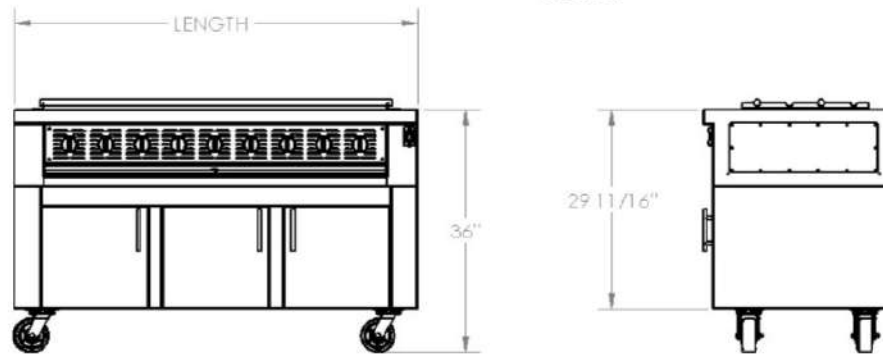

INSTALLATION INSTRUCTIONS

1. A properly sized gas line must be provided. All units are internally regulated. DO NOT DUAL REGULATE.
2. An adequate ventilation system is required for commercial use. DO NOT ATTEMPT TO OPERATE THIS EQUIPMENT WITHOUT IT.
3. Observe all local and national codes.
4. Proper combustion requires this unit to remain on casters or legs. If a curb installation is preferred, please contact CHAR Products for information in doing so.
5. This appliance is manufactured for commercial use ONLY. It is NOT intended for residential indoor use.
6. We upgrade our products regularly and in doing so, materials, specifications, and model numbers are subject to change without notice.

CHAR Products, LLC

Ph. 702-489-9888
Fax. 702-489-9898

2

Website: www.charprd.com
Email: info@charprd.com

2915 Losee Rd. Ste 106
N. Las Vegas, NV 89030

Printed in USA—Jan. 2020

© copyright 2020



ITEM NO	
QUANTITY	
JOB NAME	
JOB NO	

ROBATA STANDARD WIDTH FLOOR SOLID FUEL SPECIFICATION SHEET

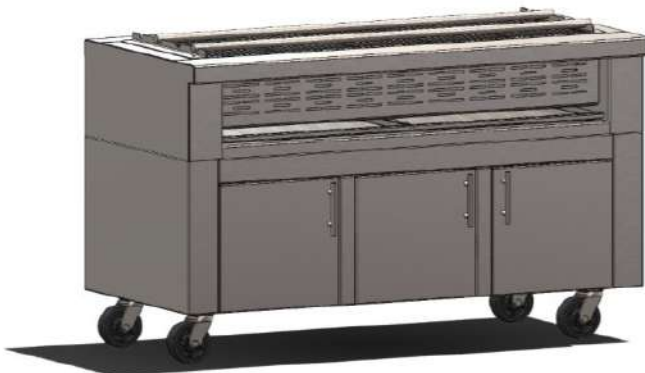

60" MODEL CP-ROBSD-FL-SF-60
SHOWN WITH AMBIENT EQUIPMENT BASE CABINET
AND OPTIONAL SWIVEL CASTERS

AVAILABLE MODELS	
<input type="checkbox"/>	CP-ROBSD-FL-SF-36
<input type="checkbox"/>	CP-ROBSD-FL-SF-48
<input type="checkbox"/>	CP-ROBSD-FL-SF-60
<input type="checkbox"/>	CP-ROBSD-FL-SF-72

STANDARD FEATURES	
•	14 gauge stainless steel body
•	Ceramic cloth insulated exterior
•	Fully welded 14 gauge stainless steel fire box
•	Ceramic fire brick lined fire box
•	1/2" Thick laser cut removable steel grates
•	Adjustable leveling feet
•	Two year warranty: parts and labor

SPECIFICATIONS

This CHAR® Robata Grill is solid fueled and constructed of 304 stainless steel. Currently available in 24", 36", 40", 48", 60", and 72" lengths. Units have a ceramic insulated exterior and a ceramic fire brick lined fire box. The quality of this grill will ensure performance and longevity.

OPTIONS	
<input type="checkbox"/>	6" SWIVEL CASTERS (TWO LOCKING)
<input type="checkbox"/>	DOUBLE-TIER RACK
<input type="checkbox"/>	1/2" THICK STAINLESS STEEL GRATE QTY: _____
<input type="checkbox"/>	1/2" THICK STAINLESS STEEL GRIDDLE PLATE QTY: _____
<input type="checkbox"/>	GRILL CLEANING KIT
<input type="checkbox"/>	EQUIPMENT BASE CABINET:
<input type="checkbox"/>	CP-EBA-ROB-XX AMBIENT MODEL
<input type="checkbox"/>	CP-EBR-ROB-XX REFRIGERATED MODEL
<input type="checkbox"/>	CP-EBF-ROB-XX FREEZER MODEL



CONSULTANT APPROVAL:	
NOTES:	
DATE:	

CHAR Products, LLC	Ph. 702-489-9888 Fax. 702-489-9898	1	Website: www.charprd.com Email: info@charprd.com	2915 Loose R.d. Ste 106 N. Las Vegas, NV 89030
--------------------	---------------------------------------	---	---	---

Printed in USA—Jan. 2020

© copyright 2020



APPLIANCES WITH SOUL™

MODEL #	LENGTH	SHIPPING WEIGHT ESTIMATED
CP-ROBSD-FL-SF-36	36"	444 LBS.
CP-ROBSD-FL-SF-48	48"	592 LBS.
CP-ROBSD-FL-SF-60	60"	740 LBS.
CP-ROBSD-FL-SF-72	72"	925 LBS.

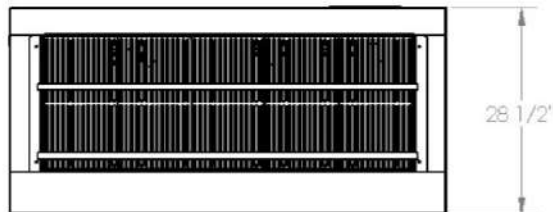

SHOWN: CP-ROBSD-FL-SF-60
WITH AMBIENT BASE CABINET AND
OPTIONAL SWIVEL CASTERS.

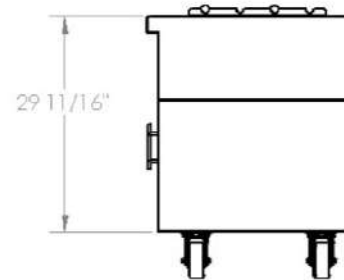
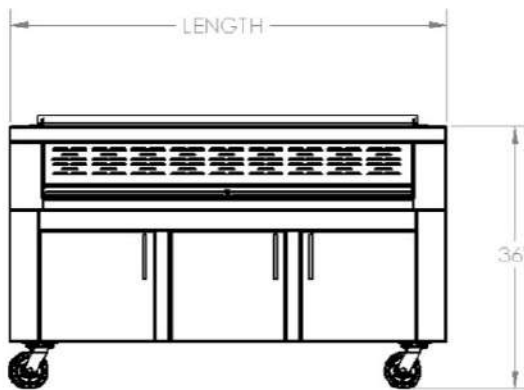

INSTALLATION INSTRUCTIONS

1. An adequate ventilation system is required for commercial use. DO NOT ATTEMPT TO OPERATE THIS EQUIPMENT WITHOUT IT.
2. Observe all local and national codes.
3. Proper combustion requires this unit to remain on casters or legs. If a curb installation is preferred, please contact CHAR Products for information in doing so.
4. This appliance is manufactured for commercial use ONLY. It is NOT intended for residential indoor use.
5. We upgrade our products regularly and in doing so, materials, specifications, and model numbers are subject to change without notice.

CHAR Products, LLC

Ph. 702-489-9888
Fax. 702-489-9898

2

Website: www.charprd.com
Email: info@charprd.com

2915 Losee Rd. Ste 106
N. Las Vegas, NV 89030

Printed in USA—Jan. 2020

© copyright 2020



ITEM NO	
QUANTITY	
JOB NAME	
JOB NO	

ROUND BROILER NON-ROTATIONAL

SPECIFICATION SHEET



48" MODEL CP-RB-48
WITH OPTIONAL PLATE SHELF

SPECIFICATIONS

The CHAR® Round Broiler uses gas fuel. Available in 38", 48", and 60" diameters. The unit serves as a heavy duty broiler and can function as a griddle when equipped with optional high polished 1" thick removable stainless steel griddle plates. These units are equipped with heavy duty cast iron lift out radiants and burners. To ensure peak performance and longevity, these units are constructed entirely out of 304 stainless steel and contain a ceramic cloth insulated exterior.

AVAILABLE MODELS

- CP-RB-38
- CP-RB-48
- CP-RB-60

STANDARD FEATURES

- 14 gauge stainless steel body
- Left and right side gas valves
- Removable drip pans
- Fully welded 14 gauge stainless steel fire box
- Ceramic cloth insulated perimeter
- 1/2" Thick laser cut removable steel grates
- Heavy duty locking swivel casters
- Removable cast iron burners and radiants
- 1" Gas connection
- Appropriate regulator for gas type selected
- Two year warranty: parts and labor

OPTIONS

- REMOVABLE 10" PLATE SHELF
- GAS FLEX QUICK DISCONNECT
- 1/4 FISH GRATES QTY: _____
- 1/4 GRIDDLE PLATE QTY: _____
- PLATE SHELF 1/6 PAN CONDIMENTS INSERT
- NATURAL GAS
- PROPANE
- GAS SAFETY

**** TYPE OF GAS MUST BE SPECIFIED ****

CONSULTANT APPROVAL:

NOTES:

DATE:



CHAR Products, LLC Ph. 702-489-9888
Fax. 702-489-9898

1

Website: www.charprd.com
Email: info@charprd.com

2915 Loose Rd. Ste 106
N. Las Vegas, NV 89030

Printed in USA—Jan. 2020

© copyright 2020



MODEL #	DIAMETER	HEIGHT	ELECTRICAL	ELECTRIC w/ gas safety	BTU INPUT -NG	SHIPPING WEIGHT EST.
CP-RB-38	38"	36.5"	120V-1PH-8A	120V-1PH-10A	168,000	1000 LBS.
CP-RB-48	48"	36.5"	120V-1PH-8A	120V-1PH-10A	198,000	1200 LBS.
CP-RB-60	60"	36.5"	120V-1PH-8A	120V-1PH-10A	222,000	1550 LBS.

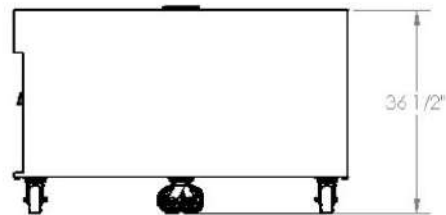
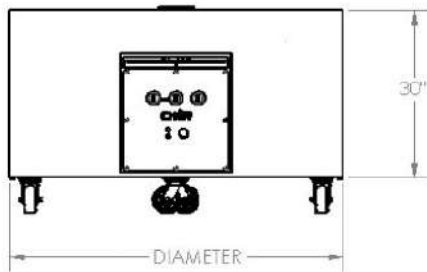
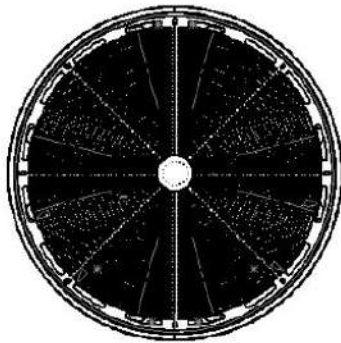

INSTALLATION INSTRUCTIONS

1. A properly sized gas line must be provided. All units are internally regulated. DO NOT DUAL REGULATE.
2. An adequate ventilation system is required for commercial use. DO NOT ATTEMPT TO OPERATE THIS EQUIPMENT WITHOUT IT.
3. Observe all local and national codes.
4. Proper combustion requires this unit to remain on casters or legs. If a curb installation is preferred, please contact CHAR Products for information in doing so.
5. This appliance is manufactured for commercial use ONLY. It is NOT intended for residential indoor use.
6. We upgrade our products regularly and in doing so, materials, specifications, and model numbers are subject to change without notice.

CHAR Products, LLC

Ph. 702-489-9888
Fax 702-489-9898

2

Website: www.charprd.com
Email: info@charprd.com

2915 Losee Rd. Ste 106
N. Las Vegas, NV 89030

Printed in USA—Jan. 2020

© copyright 2020



ITEM NO	
QUANTITY	
JOB NAME	
JOB NO	

ROUND BROILER NON-ROTATIONAL WITH FEATURE FLAME SPECIFICATION SHEET



48" MODEL CP-RBF-48
WITH OPTIONAL PLATE SHELF

SPECIFICATIONS

The CHAR® Round Broiler with Feature Flame uses gas fuel and boasts an attention grabbing central feature flame. Available in 38", 48", and 60" diameters. The unit serves as a heavy duty broiler and can function as a griddle when equipped with optional high polished 1" thick removable stainless steel griddle plates. These units are equipped with heavy duty cast iron lift out radiants and burners. To ensure peak performance and longevity, these units are constructed entirely out of 304 stainless steel and contain a ceramic cloth insulated exterior.

AVAILABLE MODELS

<input type="checkbox"/>	CP-RBF-38
<input type="checkbox"/>	CP-RBF-48
<input type="checkbox"/>	CP-RBF-60

STANDARD FEATURES

- 14 gauge stainless steel body
- Left and right side gas valves
- Removable drip pans
- Fully welded 14 gauge stainless steel fire box
- Ceramic cloth insulated perimeter
- 1/2" Thick laser cut removable steel grates
- Heavy duty locking swivel casters
- Removable cast iron burners and radiants
- 1" Gas connection
- Appropriate regulator for gas type selected
- Two year warranty: parts and labor

OPTIONS

<input type="checkbox"/>	REMOVABLE 10" PLATE SHELF
<input type="checkbox"/>	GAS FLEX QUICK DISCONNECT
<input type="checkbox"/>	1/4 FISH GRATES QTY: _____
<input type="checkbox"/>	1/4 GRIDDLE PLATE QTY: _____
<input type="checkbox"/>	PLATE SHELF 1/6 PAN CONDIMENTS INSERT
<input type="checkbox"/>	NATURAL GAS
<input type="checkbox"/>	PROPANE
<input type="checkbox"/>	GAS SAFETY

** TYPE OF GAS MUST BE SPECIFIED **

CONSULTANT APPROVAL:	_____
NOTES:	_____
DATE:	_____



CHAR Products, LLC Ph. 702-489-9888
Fax. 702-489-9898

Website: www.charprd.com 2915 Loose Rd. Ste 106
Email: info@charprd.com N. Las Vegas, NV 89030

Printed in USA—Jan. 2020

© copyright 2020



MODEL #	DIAMETER	HEIGHT	ELECTRICAL	ELECTRIC w/ gas safety	BTU INPUT –NG	SHIPPING WEIGHT EST.
CP-RBF-38	38"	36.5"	120V-1PH-8A	120V-1PH-10A	198,000	1,000 LBS.
CP-RBF-48	48"	36.5"	120V-1PH-8A	120V-1PH-10A	228,000	1,200 LBS.
CP-RBF-60	60"	36.5"	120V-1PH-8A	120V-1PH-10A	252,000	1,550 LBS.

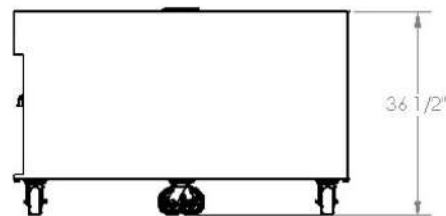
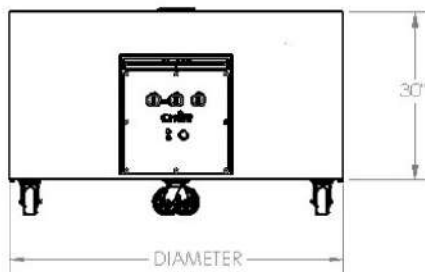
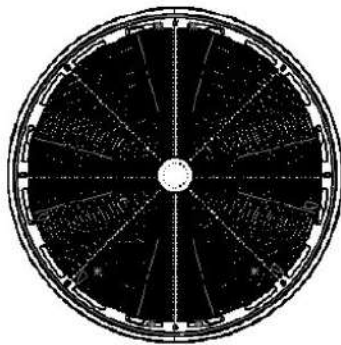

INSTALLATION INSTRUCTIONS

1. A properly sized gas line must be provided. All units are internally regulated. DO NOT DUAL REGULATE.
2. An adequate ventilation system is required for commercial use. DO NOT ATTEMPT TO OPERATE THIS EQUIPMENT WITHOUT IT.
3. Observe all local and national codes.
4. Proper combustion requires this unit to remain on casters or legs. If a curb installation is preferred, please contact CHAR Products for information in doing so.
5. This appliance is manufactured for commercial use ONLY. It is NOT intended for residential indoor use.
6. We upgrade our products regularly and in doing so, materials, specifications, and model numbers are subject to change without notice.

CHAR Products, LLC

Ph. 702-489-9888
Fax. 702-489-9898

2

Website: www.charprd.com
Email: info@charprd.com

2915 Losee Rd. Ste 106
N. Las Vegas, NV 89030

Printed in USA—Jan. 2020

© copyright 2020



ITEM NO	
QUANTITY	
JOB NAME	
JOB NO	

ROUND ROTATING BROILER

SPECIFICATION SHEET



60" MODEL CP-RRB-60
WITH OPTIONAL PLATE SHELF

SPECIFICATIONS

The CHAR® Round Broiler uses gas fuel. Available in 38", 48", and 60" diameters. The unit serves as a heavy duty rotating broiler and can function as a griddle when equipped with the optional high polished 1" thick removable stainless steel griddle plates. These units are equipped with heavy duty cast iron lift out radiants and burners. To ensure peak performance and longevity, these units are constructed entirely out of 304 stainless steel and contain a ceramic cloth insulated exterior.

AVAILABLE MODELS

- CP-RRB-38
- CP-RRB-48
- CP-RRB-60

STANDARD FEATURES

- 14 gauge stainless steel body
- Left and right side gas valves
- Removable drip pans
- Fully welded 14 gauge stainless steel fire box
- Ceramic cloth insulated perimeter
- 1/2" Thick laser cut removable steel grates
- Heavy duty locking swivel casters
- Removable cast iron burners and radiants
- 1" Gas connection
- Appropriate regulator for gas type selected
- Two year warranty: parts and labor

OPTIONS

- REMOVABLE 10" PLATE SHELF
- GAS FLEX QUICK DISCONNECT
- 1/4 FISH GRATES QTY: _____
- 1/4 GRIDDLE PLATE QTY: _____
- PLATE SHELF 1/6 PAN CONDIMENTS INSERT
- NATURAL GAS
- PROPANE
- GAS SAFETY

** TYPE OF GAS MUST BE SPECIFIED **

CONSULTANT APPROVAL:

NOTES:

DATE:



CHAR Products, LLC

Ph. 702-489-9888
Fax. 702-489-9898

1

Website: www.charprd.com
Email: info@charprd.com

2915 Loose Rd. Ste 106
N. Las Vegas, NV 89030

Printed in USA—Jan. 2020

© copyright 2020



MODEL #	DIAMETER	HEIGHT	ELECTRICAL	ELECTRIC w/ gas safety	BTU INPUT –NG	SHIPPING WEIGHT EST.
CP-RRB-38	38"	36.5"	120V-1PH-8A	120V-1PH-10A	168,000	1,000 LBS.
CP-RRB-48	48"	36.5"	120V-1PH-8A	120V-1PH-10A	198,000	1,200 LBS.
CP-RRB-60	60"	36.5"	120V-1PH-8A	120V-1PH-10A	222,000	1,550 LBS.

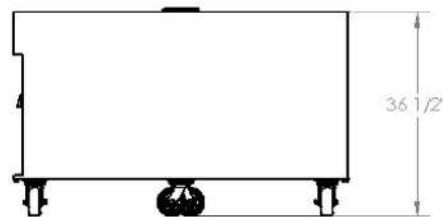
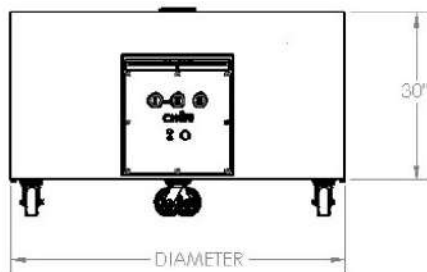
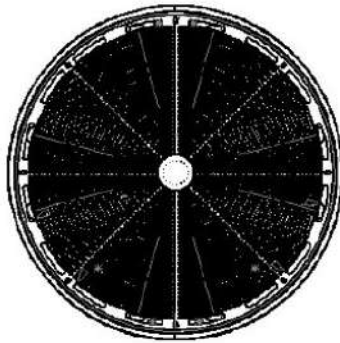

INSTALLATION INSTRUCTIONS

1. A properly sized gas line must be provided. All units are internally regulated. DO NOT DUAL REGULATE.
2. An adequate ventilation system is required for commercial use. DO NOT ATTEMPT TO OPERATE THIS EQUIPMENT WITHOUT IT.
3. Observe all local and national codes.
4. Proper combustion requires this unit to remain on casters or legs. If a curb installation is preferred, please contact CHAR Products for information in doing so.
5. This appliance is manufactured for commercial use ONLY. It is NOT intended for residential indoor use.
6. We upgrade our products regularly and in doing so, materials, specifications, and model numbers are subject to change without notice.

CHAR Products, LLC

Ph. 702-489-9888
Fax. 702-489-9898

2

Website: www.charprd.com
Email: info@charprd.com

2915 Losee Rd. Ste 106
N. Las Vegas, NV 89030

Printed in USA—Jan. 2020

© copyright 2020



ITEM NO	
QUANTITY	
JOB NAME	
JOB NO	

ROUND ROTATING BROILER WITH FEATURE FLAME SPECIFICATION SHEET



60" MODEL CP-RRBF-60
SHOWN WITH OPTIONAL PLATE SHELF

SPECIFICATIONS

The CHAR® Round Broiler with Feature Flame uses gas fuel and boasts an attention grabbing central feature flame. Available in 38", 48", and 60" diameters. The unit serves as a heavy duty broiler and can function as a griddle when equipped with the optional high polished 1" thick removable stainless steel griddle plates. These units are equipped with heavy duty cast iron lift out radiants and burners. To ensure peak performance and longevity, these units are constructed entirely out of 304 stainless steel and contain a ceramic cloth insulated exterior.

AVAILABLE MODELS

- CP-RRBF-38
- CP-RRBF-48
- CP-RRBF-60

STANDARD FEATURES

- 14 gauge stainless steel body
- Left and right side gas valves
- Removable drip pans
- Fully welded 14 gauge stainless steel fire box
- Ceramic cloth insulated perimeter
- 1/2" Thick laser cut removable steel grates
- Heavy duty locking swivel casters
- Removable cast iron burners and radiants
- 1" Gas connection
- Appropriate regulator for gas type selected
- Two year warranty: parts and labor

OPTIONS

- REMOVABLE 10" PLATE SHELF
- GAS FLEX QUICK DISCONNECT
- 1/4 FISH GRATES QTY: _____
- 1/4 GRIDDLE PLATE QTY: _____
- PLATE SHELF 1/6 PAN CONDIMENT'S INSERT
- TONG RACKS (2 EA.)
- NATURAL GAS
- PROPANE
- GAS SAFETY

** TYPE OF GAS MUST BE SPECIFIED **

CONSULTANT APPROVAL: _____ NOTES: DATE:
--



CHAR Products, LLC Ph. 702-489-9888
Fax. 702-489-9898

Website: www.charprd.com
Email: info@charprd.com

2915 Loose R.d. Ste 106
N. Las Vegas, NV 89030



MODEL #	WIDTH	HEIGHT	ELECTRICAL	ELECTRIC w/ gas safety	BTU INPUT –NG	SHIPPING WEIGHT EST.
CP-RRBF-38	38"	36.5"	120V-1PH-8A	120V-1PH-10A	198,000	1,000 LBS.
CP-RRBF-48	48"	36.5"	120V-1PH-8A	120V-1PH-10A	228,000	1,200 LBS.
CP-RRBF-60	60"	36.5"	120V-1PH-8A	120V-1PH-10A	252,000	1,550 LBS.

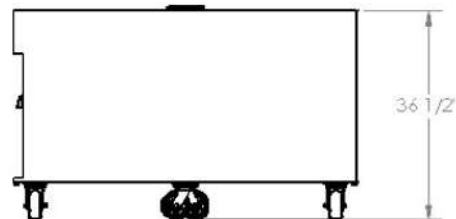
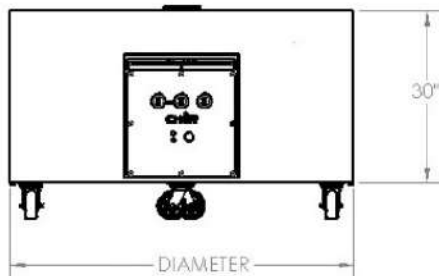
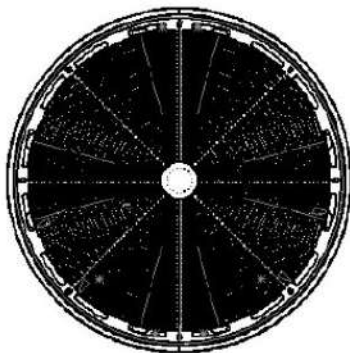

INSTALLATION INSTRUCTIONS

1. A properly sized gas line must be provided. All units are internally regulated. DO NOT DUAL REGULATE.
2. An adequate ventilation system is required for commercial use. DO NOT ATTEMPT TO OPERATE THIS EQUIPMENT WITHOUT IT.
3. Observe all local and national codes.
4. Proper combustion requires this unit to remain on casters or legs. If a curb installation is preferred, please contact CHAR Products for information in doing so.
5. This appliance is manufactured for commercial use ONLY. It is NOT intended for residential indoor use.
6. We upgrade our products regularly and in doing so, materials, specifications, and model numbers are subject to change without notice.

CHAR Products, LLC

Ph. 702-489-9888
Fax. 702-489-9898

2

Website: www.charprd.com
Email: info@charprd.com

2915 Losee Rd. Ste 106
N. Las Vegas, NV 89030

Printed in USA—Jan. 2020

© copyright 2020



ITEM NO	
QUANTITY	
JOB NAME	
JOB NO	

ROUND BROILER WITH ROTATING ROTISSERIE SPECIFICATION SHEET



48" MODEL CP-RRR-48

SPECIFICATIONS

The CHAR® Round Broiler with Rotating rotisserie, uses gas fuel and is available in two accommodating sizes: 48" and 60" diameters. The unit serves as a heavy duty grill as well as a rotisserie. These units are equipped with heavy duty cast iron lift out radiants and burners. To ensure peak performance and longevity, these units are constructed entirely out of 304 stainless steel and contain a ceramic cloth insulated exterior.

AVAILABLE MODELS

- CP-RRR-48
- CP-RRR-60

STANDARD FEATURES

- 14 gauge stainless steel body
- Left and right side gas valves
- Removable drip pans
- Fully welded 14 gauge stainless steel fire box
- Ceramic cloth insulated perimeter
- 1/2" Thick laser cut removable steel grates
- Heavy duty locking swivel casters
- Removable cast iron burners and radiants
- 1" Gas connection
- Appropriate regulator for gas type selected
- Two year warranty: parts and labor

OPTIONS

- REMOVABLE 10" PLATE SHELF
- GAS FLEX QUICK DISCONNECT
- 1/4 FISH GRATES QTY: _____
- 1/4 GRIDDLE PLATE QTY: _____
- PLATE SHELF 1/6 PAN CONDIMENTS INSERT
- NATURAL GAS
- PROPANE
- GAS SAFETY

** TYPE OF GAS MUST BE SPECIFIED **

CONSULTANT APPROVAL: _____

NOTES: _____

DATE: _____



CHAR Products, LLC

Ph. 702-489-9888
Fax. 702-489-9898

1

Website: www.charprd.com
Email: info@charprd.com

2915 Loose Rd. Ste 106
N. Las Vegas, NV 89030

Printed in USA—Jan. 2020

© copyright 2020



MODEL #	WIDTH	ELECTRICAL	ELECTRIC w/ gas safety	BTU INPUT –NG	SHIPPING WEIGHT ESTIMATED
CP-RRR-48	48"	120V-1PH-8A	120V-1PH-10A	198,000	1,350 LBS.
CP-RRR-60	60"	120V-1PH-8A	120V-1PH-10A	222,000	1,700 LBS.

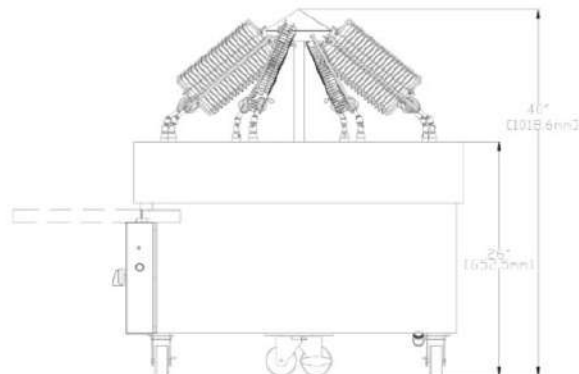
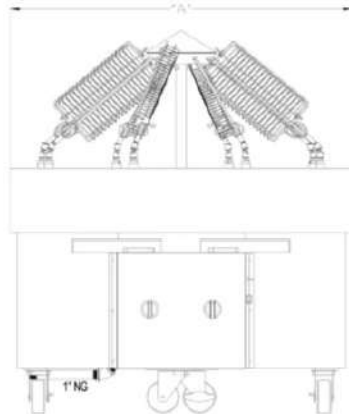
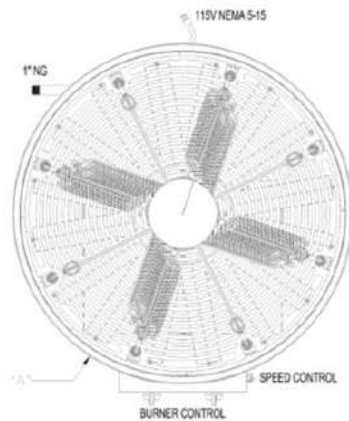

INSTALLATION INSTRUCTIONS

1. A properly sized gas line must be provided. All units are internally regulated. DO NOT DUAL REGULATE.
2. An adequate ventilation system is required for commercial use. DO NOT ATTEMPT TO OPERATE THIS EQUIPMENT WITHOUT IT.
3. Observe all local and national codes.
4. Proper combustion requires this unit to remain on casters or legs. If a curb installation is preferred, please contact CHAR Products for information in doing so.
5. This appliance is manufactured for commercial use ONLY. It is NOT intended for residential indoor use.
6. We upgrade our products regularly and in doing so, materials, specifications, and model numbers are subject to change without notice.

CHAR Products, LLC

Ph. 702-489-9888
Fax. 702-489-9898

2

Website: www.charprd.com
Email: info@charprd.com

2915 Losee Rd. Ste 106
N. Las Vegas, NV 89030

Printed in USA—Jan. 2020

© copyright 2020



ITEM NO	
QUANTITY	
JOB NAME	
JOB NO	

ROUND PLANCHA

SPECIFICATION SHEET



40" MODEL CP-RPL-40

SPECIFICATIONS

The CHAR® gas fueled Round Plancha is available in three accommodating sizes: 40", 48", and 60" diameters. This unit serves as a heavy duty griddle with a high polished stainless steel plate. To ensure peak performance and longevity, these units are constructed entirely out of 304 stainless steel. The optional rotating griddle top will showcase your product. Utilizing a tested and proven industrial gear motor, this unit offers years of uninterrupted operation of the rotating griddle surface. Adjustability achieved with a rotational speed controller. This Round Plancha will be the highlight of the cooking experience.

AVAILABLE MODELS

- CP-RPL-40
- CP-RPL-48
- CP-RPL-60

STANDARD FEATURES

- 14 gauge stainless steel body
- Left and right side gas valves
- Removable drip tray
- Fully welded 14 gauge stainless steel drip rail
- 1/2" Thick laser cut high polished stainless steel griddle plate
- Adjustable leveling feet
- Cast iron burners
- 3/4" Gas connection
- Appropriate regulator for gas type selected
- Two year warranty: parts and labor

OPTIONS

- ROTATING GRILL PLATE
- REMOVABLE 10" PLATE SHELF
- PLATE SHELF 1/6 PAN CONDIMENTS INSERTS
- 6" CASTER KIT
- NATURAL GAS
- PROPANE
- GAS SAFETY

** TYPE OF GAS MUST BE SPECIFIED **

CONSULTANT APPROVAL:
NOTES:
DATE:



CHAR Products, LLC

Ph. 702-489-9888
Fax. 702-489-9898

1

Website: www.charprd.com
Email: info@charprd.com

2915 Loose Rd. Ste 106
N. Las Vegas, NV 89030

Printed in USA—Jan. 2020

© copyright 2020



MODEL #	SIZE A	SIZE B	FUEL LINE SIZE	ELECTRIC w/gas safety	BTU INPUT -NG	SHIPPING WEIGHT EST.
CP-RPL-40	40"	26.5"	3/4"	120v-1ph-10a	168,000	475 LBS.
CP-RPL-48	48"	32.25"	3/4"	120v-1ph-10a	198,000	550 LBS.
CP-RPL-60	60"	40.25"	3/4"	120v-1ph-10a	222,000	675 LBS.

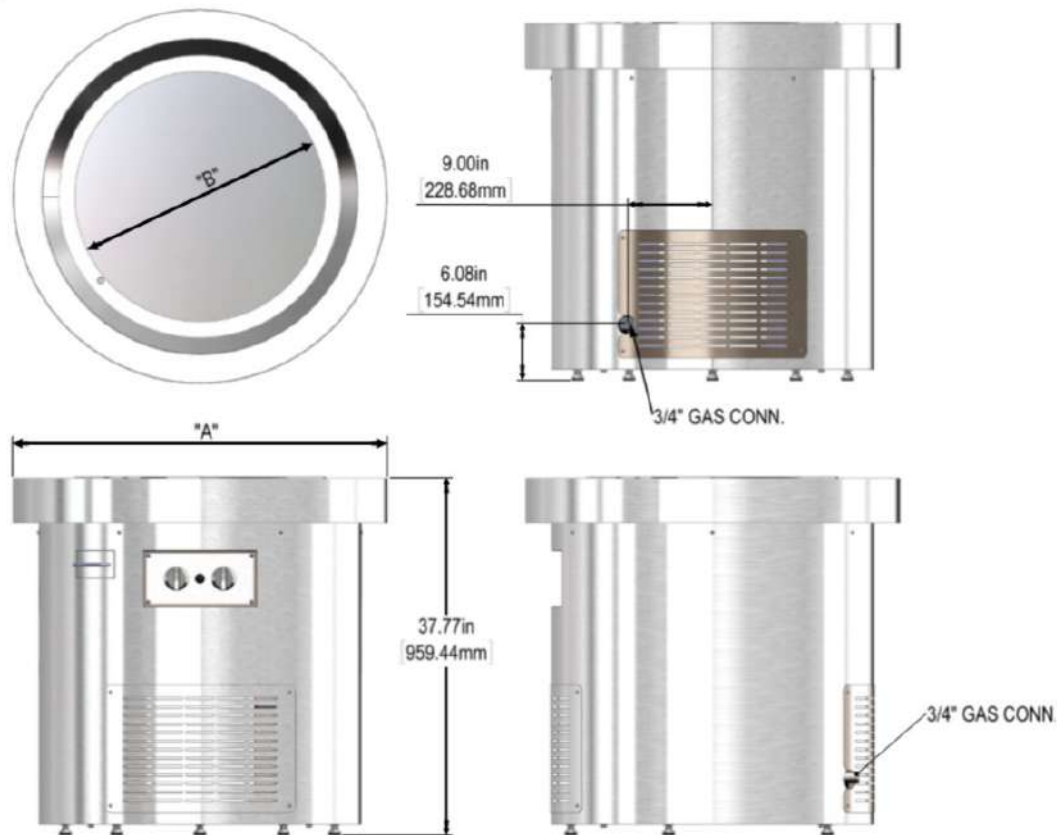

INSTALLATION INSTRUCTIONS

1. A properly sized gas line must be provided. All units are internally regulated. DO NOT DUAL REGULATE.
2. An adequate ventilation system is required for commercial use. DO NOT ATTEMPT TO OPERATE THIS EQUIPMENT WITHOUT IT.
3. Observe all local and national codes.
4. Proper combustion requires this unit to remain on casters or legs. If a curb installation is preferred, please contact CHAR Products for information in doing so.
5. This appliance is manufactured for commercial use ONLY. It is NOT intended for residential indoor use.
6. We upgrade our products regularly and in doing so, materials, specifications, and model numbers are subject to change without notice.

CHAR Products, LLC

Ph. 702-489-9888
Fax. 702-489-9898

2

Website: www.charprd.com
Email: info@charprd.com

2915 Losee Rd. Ste 106
N. Las Vegas, NV 89030

Printed in USA—Jan. 2020

© copyright 2020



ITEM NO	
QUANTITY	
JOB NAME	
JOB NO	

TORTILLA GRILL

SPECIFICATION SHEET



36 INCH MODEL CP-RSQTG-36

SPECIFICATIONS

The CHAR® gas fueled Tortilla Grill is available in 36", 48", and 60" diameters. This unit serves as a heavy duty griddle, plancha, and tortilla grill with a high polished stainless steel plate cooking surface. To ensure performance and longevity, these units are constructed entirely of 304 stainless steel. Add the optional rotational feature to showcase the grilling experience. Utilizing a tested and proven industrial gear motor, this unit option will offer years of uninterrupted operation of the rotating griddle surface. Adjustability achieved with a rotational speed controller. This Tortilla Grill will be the highlight of the cooking experience.

AVAILABLE MODELS

- CP-RSQTG-36
- CP-RSQTG-48
- CP-RSQTG-60

STANDARD FEATURES

- 14 gauge stainless steel body
- Left and right side gas valves
- Removable drip tray
- Fully welded 14 gauge stainless steel drip rail
- 1/2" Thick laser cut high polished stainless steel griddle plate
- Adjustable leveling feet
- 3/4" Gas connection
- Appropriate regulator for gas type selected
- Two year warranty: parts and labor

OPTIONS

- ROTATING GRILL PLATE
- REMOVABLE 10" PLATE SHELF
- PLATE SHELF 1/6 PAN CONDIMENTS INSERTS
- 6" CASTER KIT
- NATURAL GAS
- PROPANE
- GAS SAFETY

** TYPE OF GAS MUST BE SPECIFIED **

CONSULTANT APPROVAL:
NOTES:
DATE:



CHAR Products, LLC Ph. 702-489-9888 Fax. 702-489-9898	1	Website: www.charprd.com Email: info@charprd.com	2915 Loose Rd. Ste 106 N. Las Vegas, NV 89030
--	---	---	--

Printed in USA—Jan. 2020

© copyright 2020



APPLIANCES WITH SOUL™

MODEL #	L x W	HEIGHT	FUEL LINE SIZE	ELECTRIC w/ gas safety	BTU INPUT -NG	SHIPPING WEIGHT EST.
CP-RSQTG-36	36" x 36"	36"	3/4"	120V-1PH-10A	168,000	475 LBS.
CP-RSQTG-48	48" x 48"	36"	3/4"	120V-1PH-10A	198,000	550 LBS.
CP-RSQTG-60	60" x 60"	36"	3/4"	120V-1PH-10A	222,000	675 LBS.

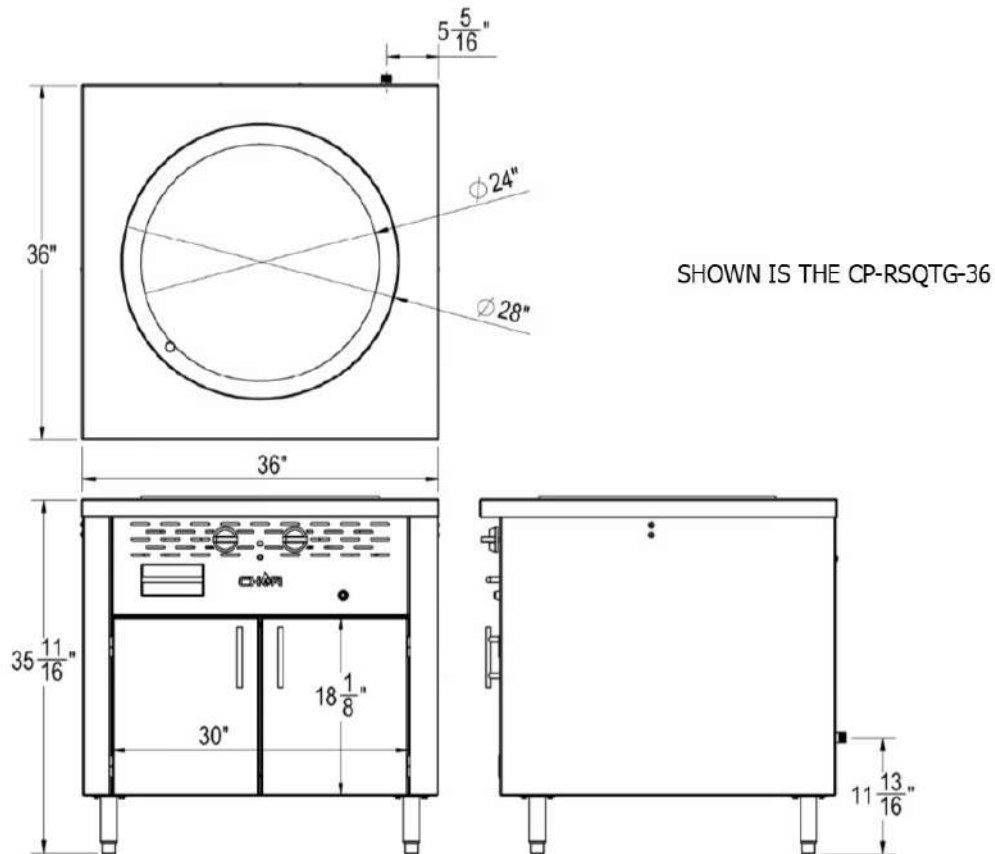

INSTALLATION INSTRUCTIONS

1. A properly sized gas line must be provided. All units are internally regulated. DO NOT DUAL REGULATE.
2. An adequate ventilation system is required for commercial use. DO NOT ATTEMPT TO OPERATE THIS EQUIPMENT WITHOUT IT.
3. Observe all local and national codes.
4. Proper combustion requires this unit to remain on casters or legs. If a curb installation is preferred, please contact CHAR Products for information in doing so.
5. This appliance is manufactured for commercial use ONLY. It is NOT intended for residential indoor use.
6. We upgrade our products regularly and in doing so, materials, specifications, and model numbers are subject to change without notice.

CHAR Products, LLC

Ph. 702-489-9888
Fax. 702-489-9898

2

Website: www.charprd.com
Email: info@charprd.com

2915 Losee Rd. Ste 106
N. Las Vegas, NV 89030

Printed in USA—Jan. 2020

© copyright 2020



ITEM NO	
QUANTITY	
JOB NAME	
JOB NO	

SARJ GAS FUEL SPECIFICATION SHEET

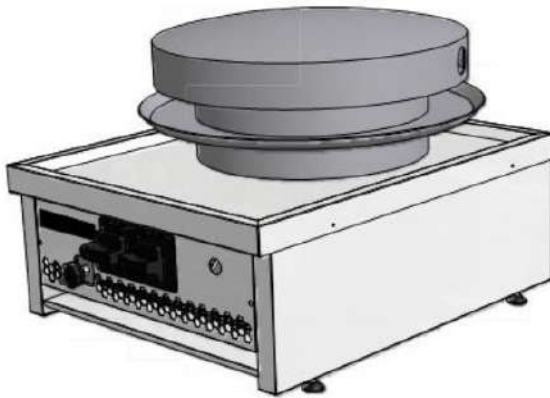

CP-SARJ-19

AVAILABLE MODELS

CP-SARJ-19

STANDARD FEATURES

- 14 gauge stainless steel body
- Domed grill surface
- Adjustable gas valve
- Full gas safety and ignitor
- Grease drip ring
- Adjustable leveling feet
- 1/2" Gas connection
- Appropriate gas regulator (for gas type selected)
- Two year warranty: parts and labor

SPECIFICATIONS

The CHAR® gas fueled Sarj Grill is great for cooking items such as naan breads. This unit has a heavy duty domed grill surface and is easily placed on or into a counter. To ensure performance and longevity these units are constructed entirely of 304 stainless steel. A cabinet or table base is also available to create a floor model.

OPTIONS

1/2" GAS FLEX QUICK DISCONNECT

NATURAL GAS

PROPANE

GAS SAFETY

CABINET BASE

TABLE BASE

** TYPE OF GAS MUST BE SPECIFIED **

CONSULTANT APPROVAL: _____

NOTES: _____

DATE: _____



CHAR Products, LLC	Ph. 702-489-9888 Fax. 702-489-9898	1	Website: www.charpd.com Email: info@charpd.com	2915 Loose Rd. Ste 106 N. Las Vegas, NV 89030
--------------------	---------------------------------------	---	---	--

Printed in USA—Jan. 2020

© copyright 2020



APPLIANCES WITH SOUL™

MODEL #	LENGTH	WIDTH	HEIGHT	FUEL LINE SIZE	ELECTRIC w/gas safety	BTU INPUT -NG	SHIPPING WEIGHT EST.
CP-SARJ-19	20 7/16"	24 5/8"	17 9/16"	1/2"	120V-1PH-5A	90,000	1100 LBS.

PLAN ELEVATION (1 : 10)

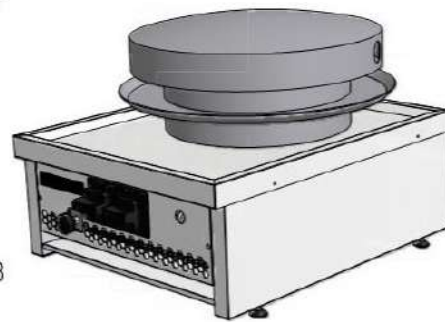
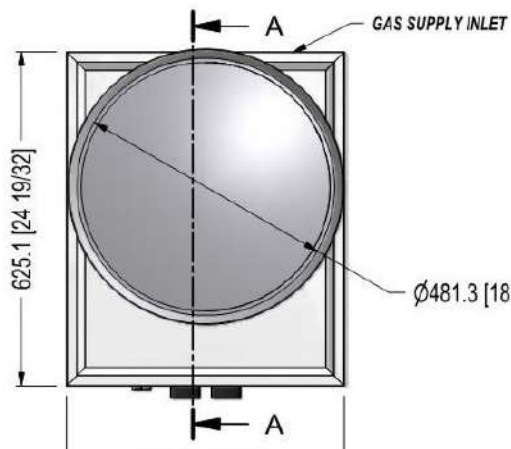

FRONT ELEVATION (1 : 10)

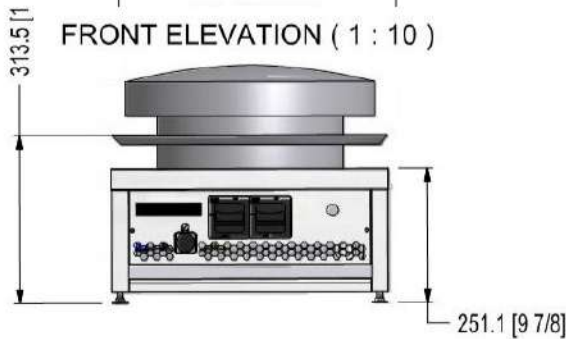

SIDE ELEVATION (1 : 10)

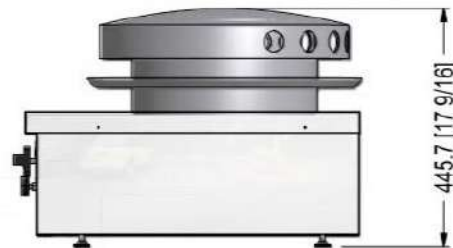

INSTALLATION INSTRUCTIONS

1. A properly sized gas line must be provided. All units are internally regulated. DO NOT DUAL REGULATE.
2. An adequate ventilation system is required for commercial use. DO NOT ATTEMPT TO OPERATE THIS EQUIPMENT WITHOUT IT.
3. Observe all local and national codes.
4. Proper combustion requires this unit to remain on casters or legs. If a curb installation is preferred, please contact CHAR Products for information in doing so.
5. This appliance is manufactured for commercial use ONLY. It is NOT intended for residential indoor use.
6. We upgrade our products regularly and in doing so, materials, specifications, and model numbers are subject to change without notice.

CHAR Products, LLC

Ph. 702-489-9888
Fax. 702-489-9898

2

Website: www.charprd.com
Email: info@charprd.com

2915 Losee Rd. Ste 106
N. Las Vegas, NV 89030

Printed in USA—Jan. 2020

© copyright 2020



ITEM NO	
QUANTITY	
JOB NAME	
JOB NO	

VERTICAL ROTISSERIE

SPECIFICATION SHEET



CP-VRTROT-33

AVAILABLE MODELS

CP-VRTROT-33

STANDARD FEATURES

- Full stainless steel construction
- Fully insulated, both interior and exterior
- Custom milled spit assemblies (2ea.)
- Infrared burners or electric elements
- Gear driven motion (no chains)
- Adjustable legs
- 45 lbs. spit capacity
- Two year warranty: parts and labor

OPTIONS

FOLD OUT HEAT SHIELDS

ELECTRIC 240V/750W

ELECTRIC 120V/750W

SKEWER ASSEMBLY

FEATURE FLAME

NATURAL GAS

PROPANE

GAS SAFETY

SPECIFICATIONS

The CHAR® Vertical Rotisserie is engineered for simple and secure skewer installation and removal. Gas fueled, this infrared heat source is currently available in 33" x 22". Smooth gear drive motion and offset heat sources provide uniform coverage of the available cooking area. The fully insulated exterior façade and interior base to ensure safe operation. Heavy duty stainless steel construction provides stability and longevity of the Vertical Rotisserie.

** TYPE OF GAS MUST BE SPECIFIED IF NOT ELECTRIC **



CONSULTANT APPROVAL: _____

NOTES: _____

DATE: _____

CHAR Products, LLC Ph. 702-489-9888 Fax. 702-489-9898	1	Website: www.charprd.com Email: info@charprd.com	2915 Loose Rd. Ste 106 N. Las Vegas, NV 89030
--	---	---	--

Printed in USA—Jan. 2020

© copyright 2020



APPLIANCES WITH SOUL™

MODEL #	LENGTH	WIDTH	ELECTRIC w/ gas safety	BTU INPUT -NG	SHIPPING WEIGHT EST.
CP-VRTROT-33	32 5/8"	31 5/16"	120V-1PH-10A	65,000	350 LBS.

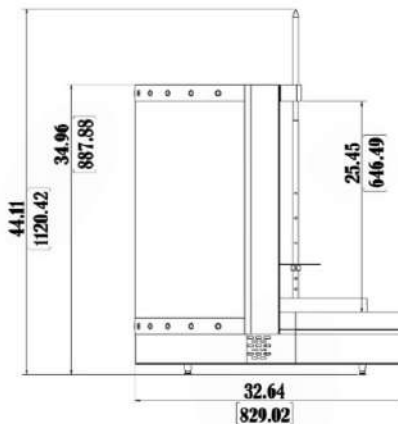
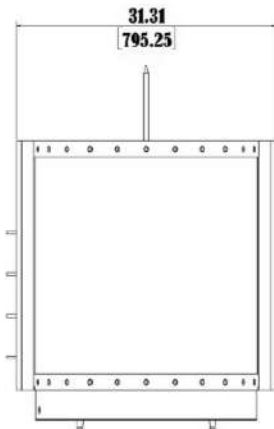
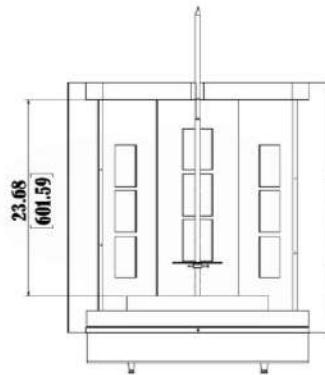
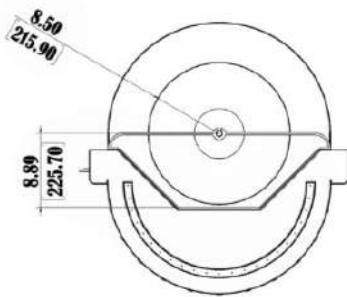

INSTALLATION INSTRUCTIONS

1. A properly sized gas line must be provided. All units are internally regulated. DO NOT DUAL REGULATE.
2. An adequate ventilation system is required for commercial use. DO NOT ATTEMPT TO OPERATE THIS EQUIPMENT WITHOUT IT.
3. Observe all local and national codes.
4. Proper combustion requires this unit to remain on casters or legs. If a curb installation is preferred, please contact CHAR Products for information in doing so.
5. This appliance is manufactured for commercial use ONLY. It is NOT intended for residential indoor use.
6. We upgrade our products regularly and in doing so, materials, specifications, and model numbers are subject to change without notice.

CHAR Products, LLC

Ph. 702-489-9888
Fax. 702-489-9898

2

Website: www.charprd.com
Email: info@charprd.com

2915 Losee Rd. Ste 106
N. Las Vegas, NV 89030

Printed in USA—Jan. 2020

© copyright 2020



CHAR[®] Products produces Ambient temperature showcase equipment that allows you to highlight and display your products.



ITEM NO	
QUANTITY	
JOB NAME	
JOB NO	

ROUND ROTATING DESSERT DISPLAY

SPECIFICATION SHEET



CP-RRDD-42

AVAILABLE MODELS

<input type="checkbox"/>	CP-RRDD-36
<input type="checkbox"/>	CP-RRDD-42
<input type="checkbox"/>	CP-RRDD-48

STANDARD FEATURES

- 1/2" Thick tempered glass shelves
- Segmented bottom shelf for easy cleaning
- Dual speed controls
- Full 304 stainless steel construction
- Mirror finish stainless steel center column
- Heavy duty drive motor
- Two year warranty: parts and labor

SPECIFICATIONS

The CHAR® Round Rotating Dessert Display is a glass, three tier product display unit. This ambient temperature display case elegantly shows any dessert pastry product in a 360 degree view for maximum presentation. Speed control allows for the setting at optimal viewing pleasure and can be slowed or turned off easily. Designed to be integral to a counter with the base hidden behind the cabinet and only the glass shelves visible. The bottom glass section is in four segments for easy removal and cleaning. The upper glass shelves are easily cleaned from top to bottom.

OPTIONS

<input type="checkbox"/>	STAINLESS STEEL CABINET BASE
<input type="checkbox"/>	NEMA 5-15 115V PLUG
<input type="checkbox"/>	STARFIRE GLASS SHELVES
<input type="checkbox"/>	LOCKING CABINET DOORS



CONSULTANT APPROVAL: _____

NOTES: _____

DATE: _____

CHAR Products, LLC	Ph. 702-489-9888 Fax. 702-489-9898	1	Website: www.charprd.com Email: info@charprd.com	2915 Lusse Rd. Ste 106 N. Las Vegas, NV 89030
--------------------	---------------------------------------	---	---	--

Printed in USA—Jan. 2020

© copyright 2020



MODEL #	STANDARD DIAMETER	ELECTRIC	SHIPPING WEIGHT ESTIMATED
CP-RRDD-36	36"	120V-1PH-20A	650 LBS.
CP-RRDD-42	42"	120V-1PH-20A	725 LBS.
CP-RRDD-48	48"	120V-1PH-20A	800 LBS.

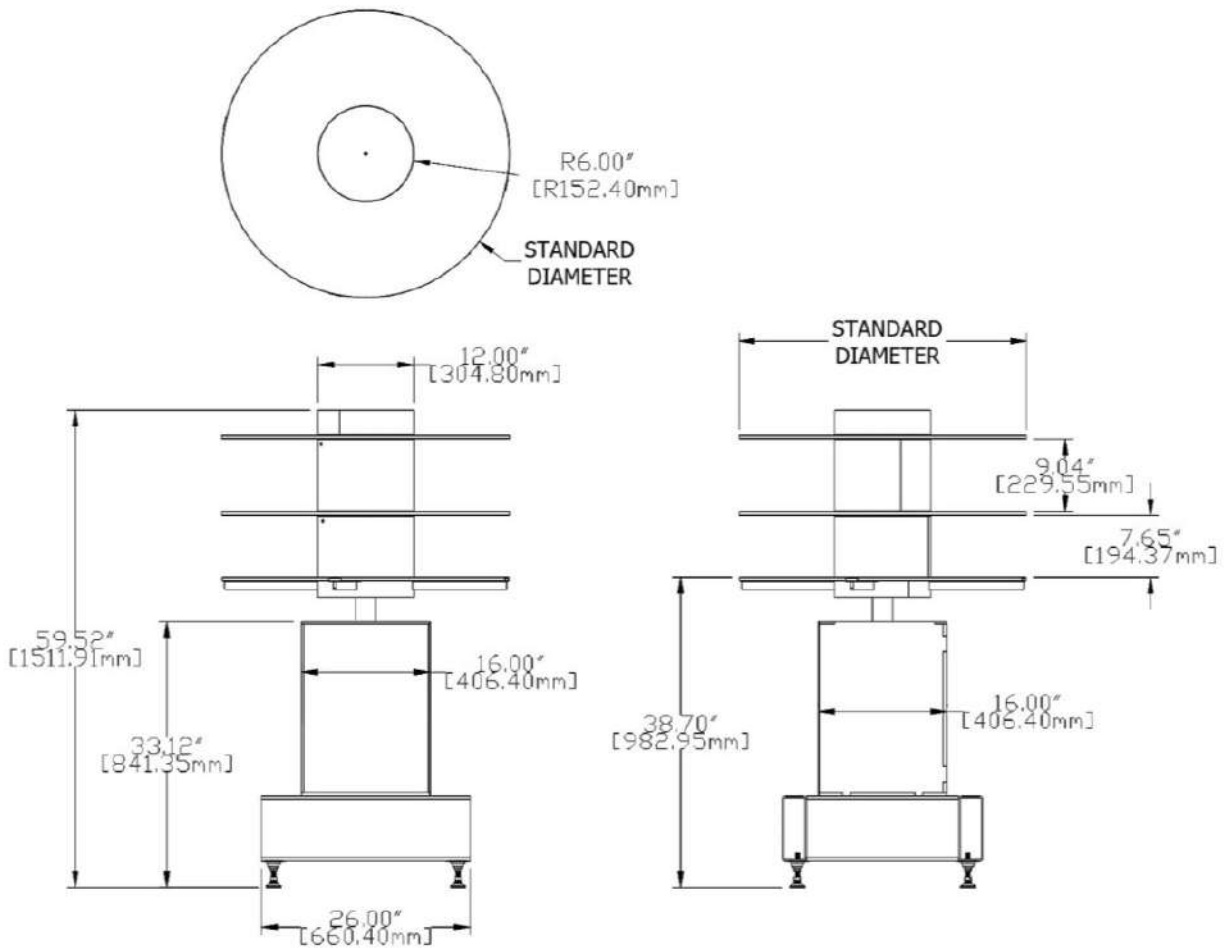

INSTALLATION INSTRUCTIONS			
1. Observe all local and national codes. 2. This appliance is manufactured for commercial use ONLY. It is NOT intended for residential use. 3. We upgrade our products regularly and in doing so, materials, specifications, are subject to change without notice.			
CHAR Products, LLC	Ph. 702-489-9888 Fax. 702-489-9898	2	Website: www.charprd.com Email: info@charprd.com
		2915 Losee Rd. Ste 106 N. Las Vegas, NV 89030	

Printed in USA—Jan. 2020

© copyright 2020



ITEM NO	
QUANTITY	
JOB NAME	
JOB NO	

EQUIPMENT BASE AMBIENT SPECIFICATION SHEET



60" MODEL CP-EBA-60
SHOWN WITH OPTIONAL SWIVEL CASTERS

AVAILABLE MODELS

- CP-EBA-36
- CP-EBA-48
- CP-EBA-60
- CP-EBA-72

STANDARD FEATURES

- Stainless steel interior and exterior
- LEED certified foamed in place high density polyurethane insulation
- Heavy duty 6" adjustable legs
- Stainless steel adjustable wire shelving included
- Two year warranty: parts and labor

SPECIFICATIONS

CHAR® Products has over 20 years experience designing, engineering and manufacturing commercial kitchen equipment. Our products reside all over the United States.

Contact our sales team if you require a custom solution for your project.

OPTIONS

- FOUR 6" ROLLING CASTERS (TWO LOCKING)
- CUSTOM SHELIVING

CONSULTANT APPROVAL: _____

NOTES: _____

DATE: _____



CHAR Products, LLC	Ph. 702-489-9888 Fax. 702-489-9898	1	Website: www.charprd.com Email: info@charprd.com	2915 Losee Rd. Ste 106 N. Las Vegas, NV 89030
---------------------------	---------------------------------------	---	--	--

Printed in USA — Jan. 2020

© copyright 2020



MODEL #	LENGTH	SHIPPING WEIGHT ESTIMATED
CP-EBA-36	36"	275 LBS.
CP-EBA-48	48"	300 LBS.
CP-EBA-60	60"	325 LBS.
CP-EBA-72	72"	375 LBS.

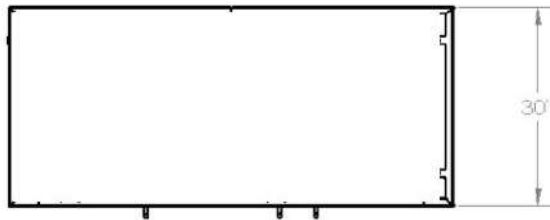

NOTE: THE NUMBER AND SIZE OF DOORS CHANGE WITH THE UNIT SIZE. ACTUAL DIMENSIONS WILL BE FINALIZED IN THE APPROVAL DRAWINGS.

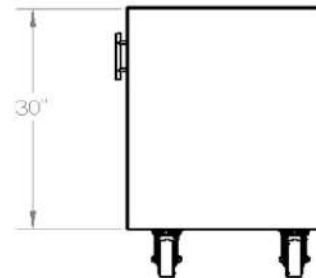
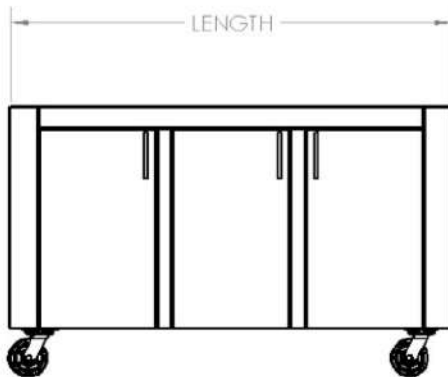

SHOWN: CP-EBA-60 WITH OPTIONAL SWIVEL CASTERS.

INSTALLATION INSTRUCTIONS			
<ol style="list-style-type: none"> 1. Observe all local and national codes. 2. This appliance is manufactured for commercial use ONLY. It is NOT intended for residential indoor use. 3. We upgrade our products regularly and in doing so, materials, specifications, and model numbers are subject to change without notice. 			
CHAR Products, LLC Ph. 702-489-9888 Fax. 702-489-9398	2	Website: www.charprd.com Email: info@charprd.com	2915 Losee Rd. Ste 106 N. Las Vegas, NV 89030

Printed in USA — Jan. 2020

© copyright 2020



Radiant

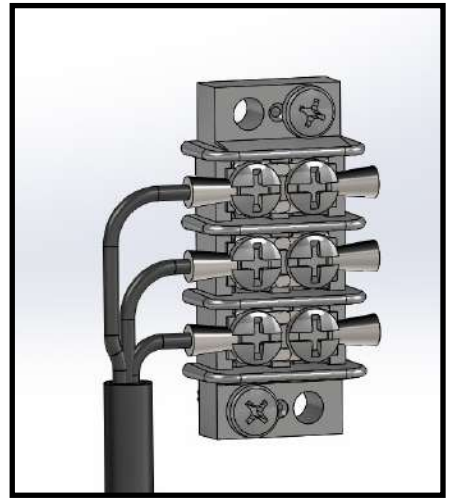
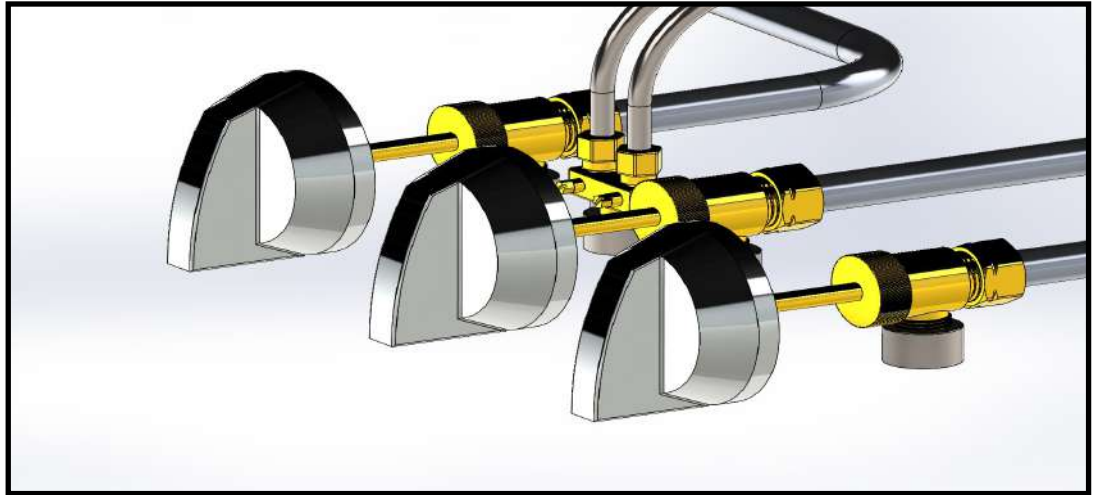

At CHAR[®] Products, we create radiant showcase equipment, making the front of house experience unique and unforgettable. Let us take your creative ideas and turn them into the center piece of your next project.



CHAR[®]

CHAR[®]

CHAR[®]

CHAR[®] Products has the experience and talent to consult, design, and fabricate your next project. From concept to finished product, we deliver.

Contact our sales team:

Office (702) 489-9888

Fax (702) 489-9898

Email info@charprd.com

Web www.charprd.com

Address Char Products, LLC

2915 Losee Road Ste 106

North Las Vegas, NV 89030

Follow us on:

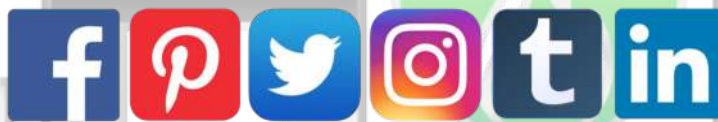

NOTES:

NOTES:

NOTES:



Cold



Hot



Ambient



Radiant

CHAR[®] Products would like to thank you for your choice to take a look at our offerings. It is our intent to develop lasting customer relations. We take pride in our products.

Our goal is for the quality and functionality of the last piece of equipment sold to sell the next. Again, thank you. We hope, that in the future, you will choose to make CHAR[®] Products your choice for custom equipment that will

“Ignite Your Imagination.”



Cold



Hot



Ambient



Radiant



Appliances with Soul™

Thank you for your interest.