

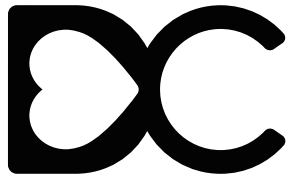

Read all instructions
before assembly and use.
KEEP INSTRUCTIONS FOR
FUTURE USE.

Lisez toutes les instructions avant
l'assemblage et l'utilisation.
CONSERVEZ LES INSTRUCTIONS
POUR UN USAGE ULTERIEUR.

Lea todas las instrucciones
antes de ensamblar y usar.
MANTENGA LAS INSTRUCCIONES
PARA SU USO FUTURO.



DELTACHILDREN

2 CHAIR & TABLE SET
ENSEMBLE DE 2 CHAISES
ET TABLE
JUEGO DE 2 SILLAS Y MESA

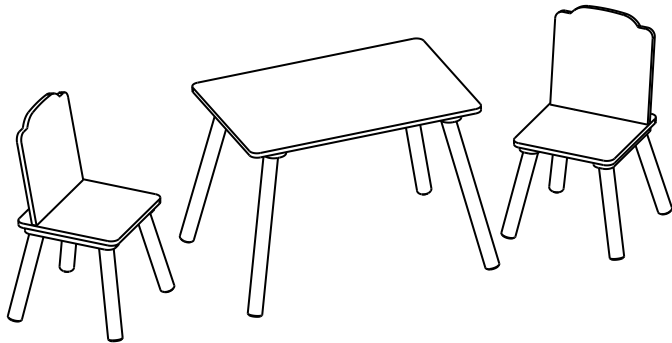

⚠ ADULT ASSEMBLY REQUIRED
Due to the presence of small parts during assembly, keep out
of reach of children until assembly is complete.

**⚠ L'ASSEMBLAGE DOIT ETRE FAIT
PAR UN ADULTE**

A cause de la presence de petites pieces, pendant l'assemblage
gardez hors de portee des enfants jusqu'a ce que celui-ci soit
termine.

**⚠ DEBE SER ENSAMBLADO
POR UN ADULTO**

Debido a la presencia de piezas pequeñas durante el
ensamblaje, mantenga fuera del alcance de los niños hasta que
complete el ensamblaje.

This product is not intended for institutional or commercial use.
Ce produit ne pas destine a un usage institutionnel ou commercial.
Este producto no esta hecho para uso institucional o comercial.

NEED EXTRA HELP?

We make assembly easy with
our tips & tricks video

[https://www.deltachildren.com/
pages/instructions](https://www.deltachildren.com/pages/instructions)

BESOIN D'AIDE SUPPLÉMENTAIRE?

Nous facilitons l'assemblage avec
nos trucs et astuces vidéo

[https://www.deltachildren.com/
pages/instructions](https://www.deltachildren.com/pages/instructions)

¿NECESITA AYUDA EXTRA?

Hacemos el montaje fácil con
nuestros consejos y trucos video

[https://www.deltachildren.com/
pages/instructions](https://www.deltachildren.com/pages/instructions)

When contacting Delta Consumer Care, please reference the information on the Product Information label found on the product.

Lorsque vous contactez le Service après Vente de Delta, veuillez nous donner les références sur l'étiquette d'Information qui se trouve sur le produit.

Cuando contacte al Servicio de Atención al Consumidor de Delta por favor mencione los datos que aparecen en la etiqueta de información que se encuentra en el producto.



Product information label
L'étiquette d'information
Etiqueta de información

Consumer Care:

Delta Children's Products Corp
114 West 26th Street New York, NY 10001

Tel: (646) 435-8728

Email: tcs@DeltaChildren.com

<https://www.deltachildren.com/pages/instructions>



SAVE BIG WITH DELTA CHILDREN

Visit Deltachildren.com To Start Shopping

Welcome to the
DELTA FAMILY
Here's a Gift From Us To You

10% OFF

Your Next Purchase From
DeltaChildren.com

USE CODE:
DELTA10

*Exclusions Apply
*Subject to Change

REVIEW TO WIN \$2500

RULES TO ENTER



"We LOVE, LOVE, LOVE this crib"

My husband was impressed with the directions and organization of the hardware package. He easily assembled this crib in an hour without any help. It's very sturdy and we like that it has adjustable levels for the mattress height. To top it all off, it's so incredibly darling!!!

- 1** **WRITE A REVIEW** for this product on the store's website from where it was purchased
- 2** **TAKE A SCREENSHOT** of your review and upload it to www.DeltaChildren.com/Review
- 3** **IT'S THAT EASY!** Upon submission, you'll be instantly **ENTERED TO WIN \$2,500**

FOLLOW US FOR MORE CHANCES TO WIN



@deltachildren

SCAN HERE



For more information
and to see all of our
products



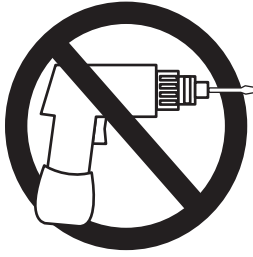

Required Tools
Outils Nécessaires
Herramientas necesarias

4 x
AA

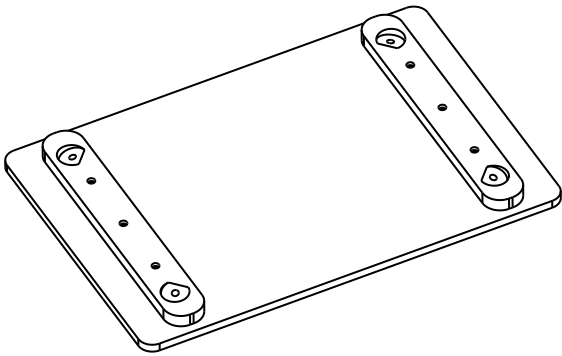

A x 1

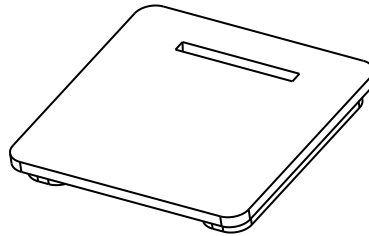

B x 2

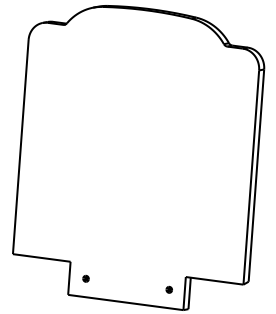

C x 2

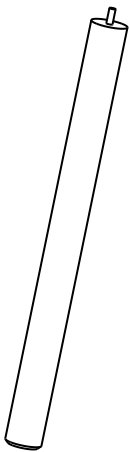

D x 4

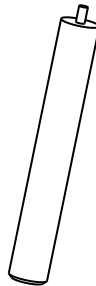

E x 8

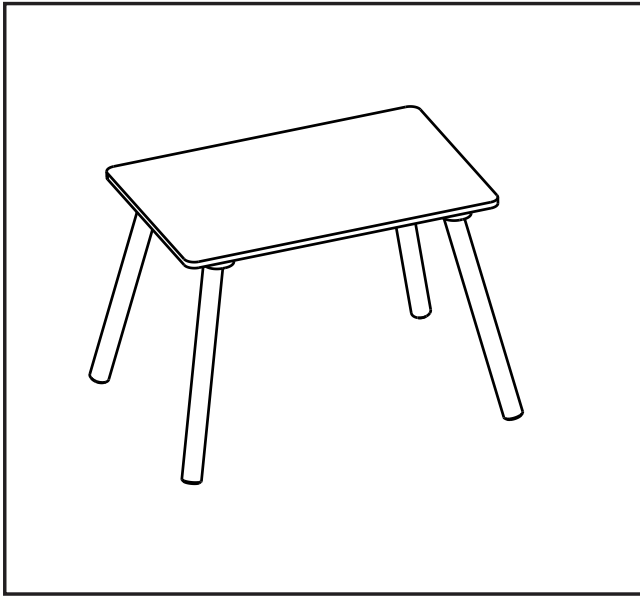

1

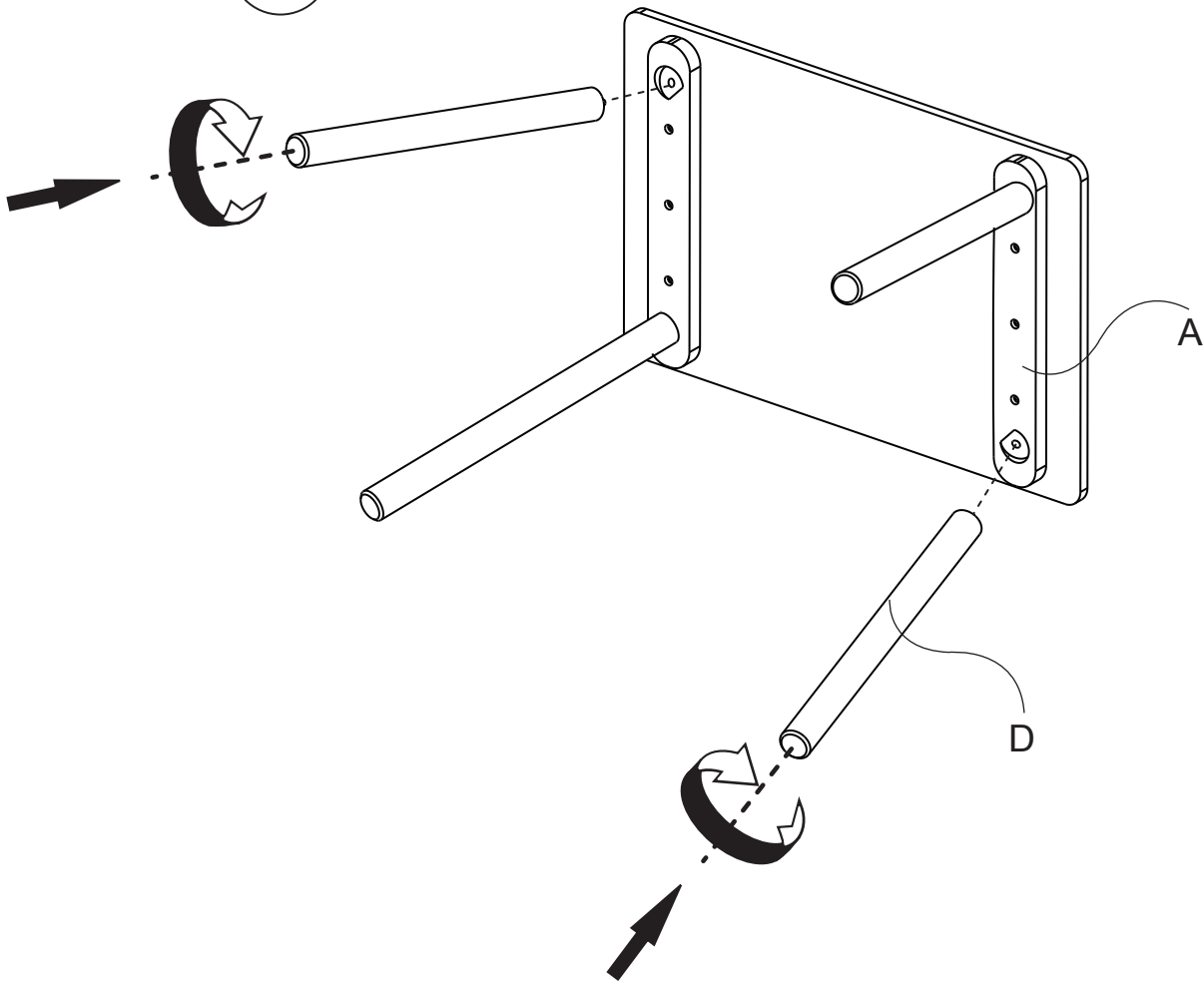

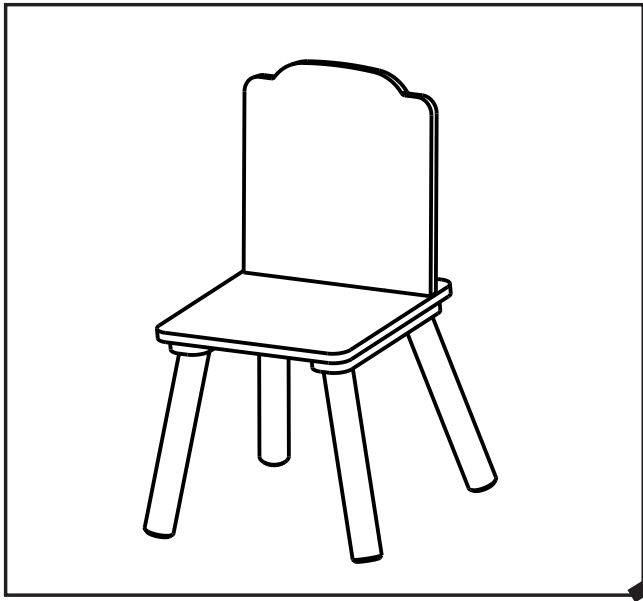

1

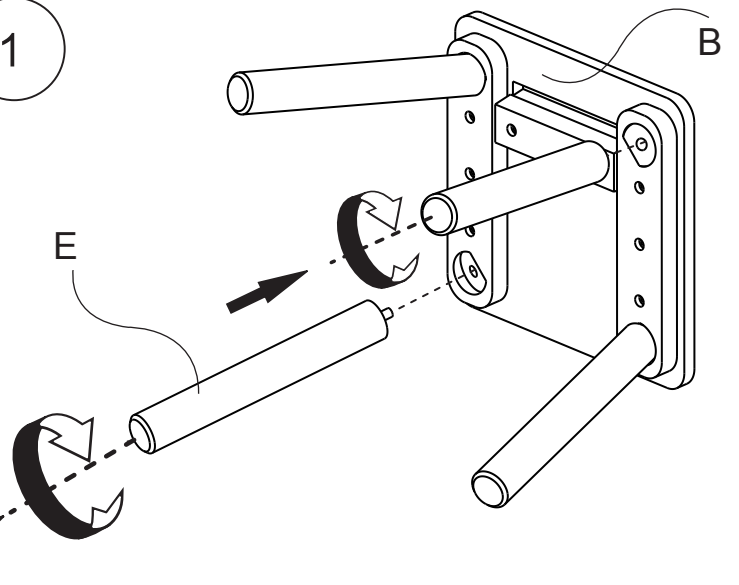

2

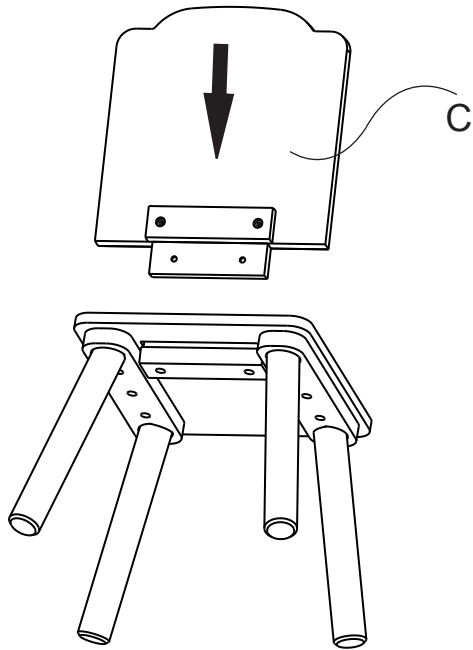

3

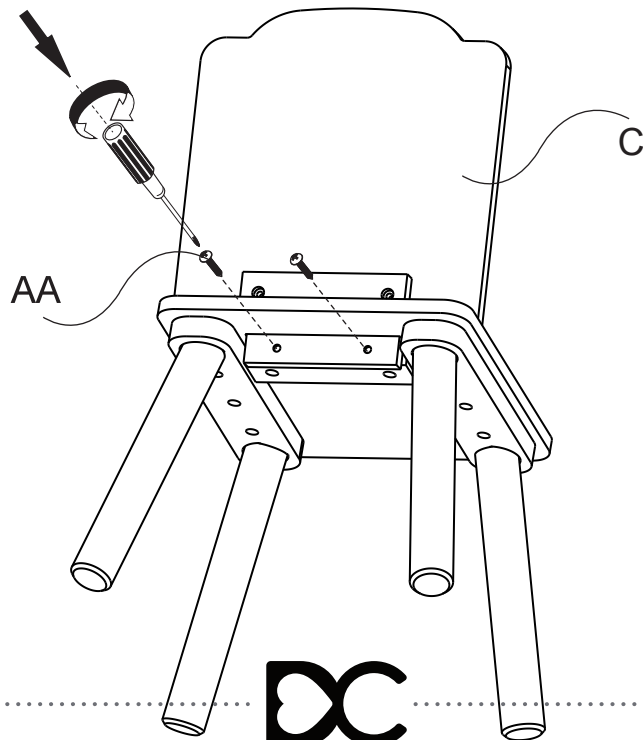

♥♥♥
**WHY CHOOSE
 DELTA CHILDREN?**

Visit Deltachildren.Com/Pages/Our-Story for more information

<p>DELTA LEADS 1 Out Of 2 Children In The U.S. Sleep In Our Products</p>	<p>DELTA GIVES 10% Of Our Proceeds Go Toward Improving The Lives Of Children</p>	<p>DELTA CARES We Test Above & Beyond Industry Safety Standards</p>	<p>DELTA IS DEDICATED Our Family-Run Company Has Been There For Your Family Since 1968</p>	<p>DELTA GROWS WITH YOU We Have Products For Every Age And Stage</p>	<p>Over 50 Years Of Safety, Style & Innovation</p>
--	--	---	--	--	---

Welcome to the **DELTA FAMILY**
 Here's a Gift From Us To You











10% OFF

Your Next Purchase From DeltaChildren.com

USE CODE:
DELTA10

*Exclusions Apply
 *Subject to Change

PRODUCTS FOR EVERY AGE AND STAGE

 CRIBS	 STROLLERS	 GLIDERS	 BASSINETS	 MATTRESSES	
 BABY GEAR	 TODDLER BEDS	 PLAYROOM FURNITURE	 TWIN BEDS	 BINS & ORGANIZERS	 DRESSERS

OUR FAMILY OF TOP BRANDS



OVER 50 YEARS OF SAFETY, STYLE, AND INNOVATION

