

TURBOGLYDE REVERSIBLE HANDLE STROLLER

Jeep[®]

by DELTA CHILDREN

INSTRUCTION MANUAL

ADULT ASSEMBLY REQUIRED
STYLES AND COLORS MAY VARY

12597A



Fits Graco[®] SnugRide[®] Click Connect[™] Infant Car Seat (not included)
Fits Evenflo[®] Embrace[™] Select Infant Car Seat (not included)
Fits Evenflo[®] Nurture[™] Infant Car Seat (not included)

NOTE: When child is facing front (away from parent), you can lock the rear wheels for swivel for easy navigation

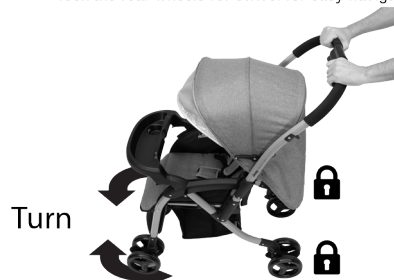

NOTE: When child is facing rear (towards parent), you can lock the two front wheels for easy navigation



**⚠ WARNING:
CHOKING HAZARD**

Adult assembly required because of small parts. Keep assembly parts out of reach of children under 3 years.

Read all instructions BEFORE assembly and USE of product
KEEP INSTRUCTIONS FOR FUTURE USE.

Customer Experience Center
email: gcs@DeltaChildren.com



www.DeltaChildren.com

This stroller is not from, sponsored or endorsed by Graco Children's Products Inc.

This stroller is not from, sponsored or endorsed by Evenflo Company, Inc.

DCP-IM-20231211

WARNING

WARNING: Please follow all of these instructions to ensure the safety of your child.
Keep these instructions for future reference.

WARNING: Failure to follow these instructions could result in serious injury or death.

- Avoid serious injury from falling or sliding out. **ALWAYS** insure that the child is properly positioned by using the safety harness according to these instructions. **ONLY** children who have developed enough upper body control to sit without leaning forward can use the front seat in the upright position.
- **NEVER** leave children unattended.

WARNING: CHOKING HAZARD Adult assembly required because of small parts.
Keep (assembly parts) out of reach of children under 3 years.

CAUTION: Purses, shopping bags, parcels, diaper bags or accessory items may change the balance of the stroller and cause hazardous unstable conditions.

TO PREVENT INJURY

- Make sure all body parts are clear of the stroller when folding and unfolding.
- The maximum weight that can be carried in the lower basket, and child tray, each is 3 lbs (1.36 kg). Excessive weight may cause a hazardous unstable condition to exist.
- Before allowing the children near the stroller, be certain the stroller is fully erect and latched in the open locked position.
- Use of the stroller with children weighing more than 50 pounds (22.62 kg) or over 42 inches (106.7 cm) tall, may cause a hazardous unstable condition to the stroller.
- **NEVER** use the stroller on stairways or escalators.
- **NEVER** allow your stroller to be used as a toy.
- **NEVER** use the stroller in conjunction with bicycles, skateboards, roller skates, or in-line skates. Please discuss using the jogging stroller with your health care provider prior to jogging use. We recommend that the child occupant needs to be 6 months of age, at the minimum, before use of the stroller.

Product features and decorations may vary from the photo.

WARNING:

**Child may slip into leg openings and strangle.
Never use in reclined carriage position(s) unless
footrest is folded up and snapped.**

CARE AND MAINTENANCE

- To clean the plastic parts on stroller use a mild cleaning solution with warm water on a sponge or damp cloth. Hand wash fabric with damp cloth and air dry. Do not use bleach.
- To keep your stroller wheels from squeaking, use silicone or graphite based lubricant.
- Check your stroller for loose screws, worn parts, torn material or stitching on a regular basis. Replace or repair parts as needed, discontinue use of stroller if it should become damaged or malfunctions.



Before returning this product to the store! Let's see if we can assist you!

- **Not sure how to assemble our product?**

Visit our site for easy to follow instructions along with some Tricks and Tips assembly videos <https://www.deltachildren.com/pages/instructions>

- **If you are missing a piece or have a damaged part**

Please contact our Consumer Experience Center for assistance at gcs@DeltaChildren.com. To better assist you please have your Style# or Model# and Lot# available. This can be found on a white rectangular sticker on your product, on the registration card, and on the product's box.

- **In the event we do not have a replacement part available**

You may need to return your product to the retailer for an exchange or refund.

- **Warranty**

In order to protect your investment, don't forget to register your product. You may also wish to consider purchasing our extended warranty.

Visit <https://www.deltachildren.com/pages/extended-warranty> for more details.

- **Please note:**

"All Final", "As Is" or Third Party/Liquidator sales are not covered under our Limited Manufacturer Warranty.

DELTA CHILDREN

LIMITED MANUFACTURER WARRANTY

This Delta product is warranted to be free from defects for a period of 90 days from the date of purchase under normal use. If a product is defective during this period, we will at our option repair or replace the defective part or product. This limited warranty extends only to the original retail purchaser and is valid only when supplied with proof of purchase, or if received as a gift, when the registration is on file with Delta.

This limited warranty does not cover the following:

- Products purchased as floor models or samples.
- Items purchased on an “as-is” basis, as a second hand product, or as a resale product.
- Items purchased at a Final sale, a “Going out of Business” sale, or a Liquidation sale. This limited warranty gives you specific legal rights and you may also have other rights which vary from state to state.

This limited warranty gives you specific legal rights and you may also have other rights which vary from state to state.

TO REGISTER YOUR PRODUCT for important safety alerts and updates to your product please visit www.deltachildren.com

TO REPORT A PROBLEM, please log on to www.deltachildren.com and click the Consumer Care Tab.

EXTENDED WARRANTY

DON'T MISS YOUR CHANCE TO BE COVERED FOR ALL OF LIFE'S MISHAPS!

With Delta's Extended Warranty, you're covered for mechanical failure from normal use or if your item stops working due to normal wear and tear, plus all those unexpected surprises.

2 YEARS OF PROTECTION

For Additional Information:

Simply visit our Website, register your product, and add the Extended Warranty

<https://www.deltachildren.com/pages/product-registration>

Extended Warranty only available in the following States: Arkansas, Colorado, Delaware, District of Columbia, Georgia, Idaho, Illinois, Indiana, Iowa, Kansas, Kentucky, Louisiana, Maryland, Michigan, Mississippi, Missouri, Nebraska, Nevada, New Hampshire, New York, North Carolina, North Dakota, Pennsylvania, Rhode Island, South Dakota, Tennessee, Utah, West Virginia

Parts

IMPORTANT! Please remove all parts from the package and identify them before assembly.

IMPORTANT! Before assembly and each use, inspect this product for damaged hardware, loose joints, missing parts, or sharp edges. NEVER use if any parts are missing or broken. Contact manufacturer for replacement parts and instructions if needed. Never substitute parts. **IMPORTANT!** Adult assembly is required.

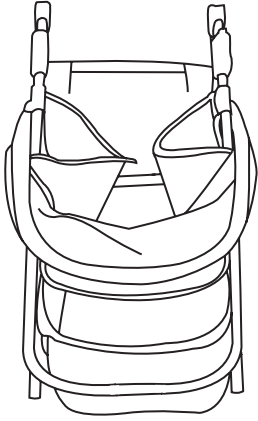

Stroller Frame

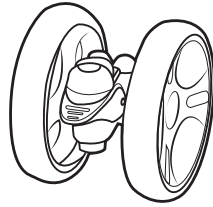

Wheels x 4

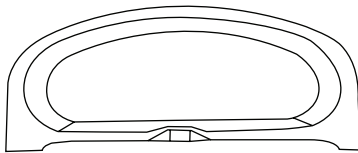

Child Tray

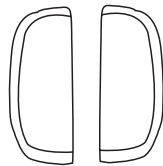

Shoulder Pads x 2

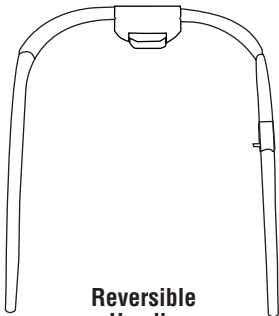

Reversible Handle

Assembly

Remove stroller from box. The front wheels, rear wheels, reversible handle, and child tray need to be installed prior to use.

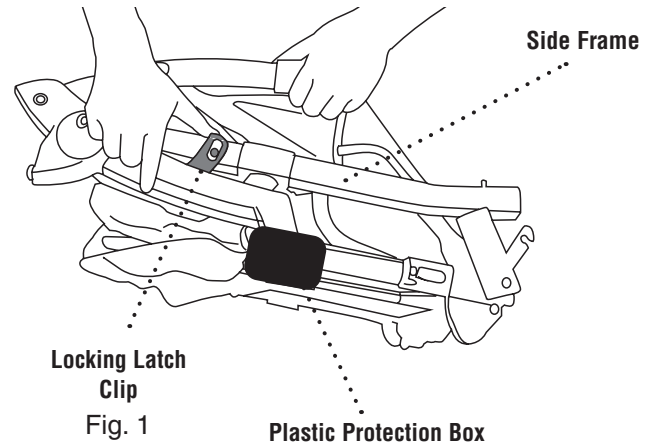

1

Opening Stroller

- First, remove the plastic protection box located on the reversible handle levers.
- Second, release the locking latch clip which is located on the right side of the stroller. (Fig. 1)
- Third, lift stroller until it “CLICKS” into a fully opened locked position.

Assembly Wheels

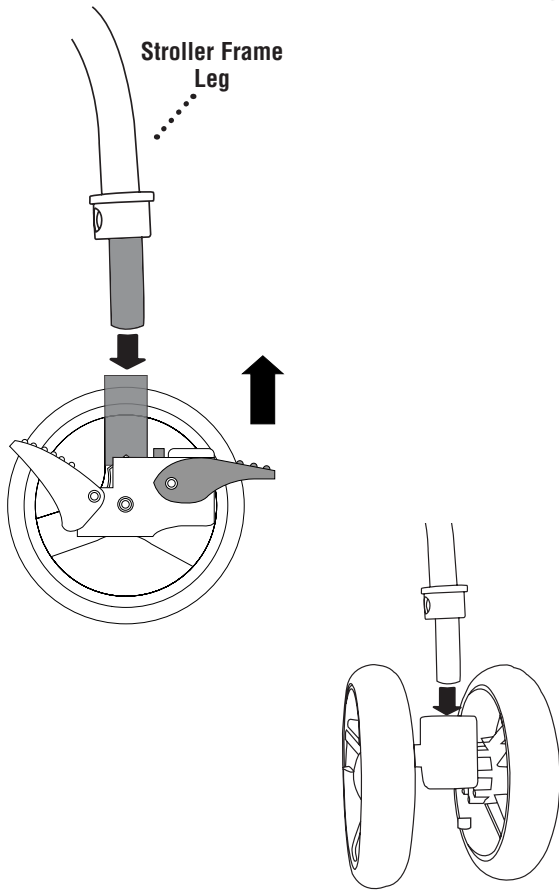
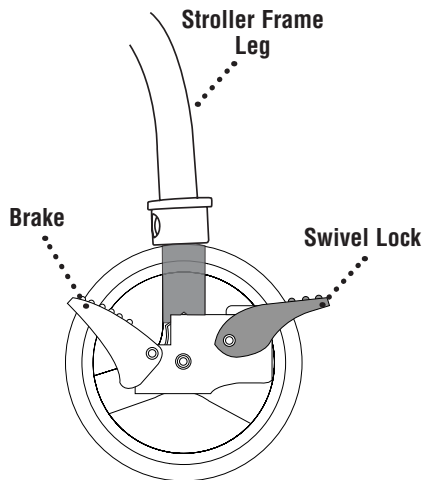

Fig. 4



Fully Assembled and Locked in Position

Fig. 4A

2

Attaching Wheels

- Locate the four (4) legs on the stroller.
- Attach one wheel to the stroller frame leg (Fig. 4), making sure the wheel swivel lock on the wheel is facing up. You will hear a “snap” once they are in a fully locked position. (Fig. 4A) Check to make sure the wheel is fully secure by pulling downward.
- Repeat on the three (3) other legs.

Assembly Reversible Handle

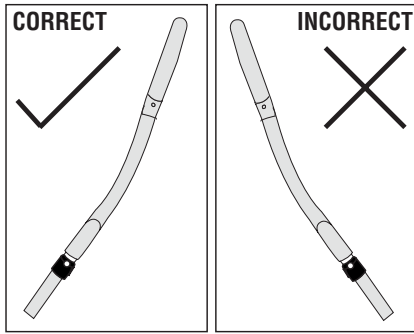

Make sure handle is in this direction

Fig. 3

NOTE: Reversible Handle Housing **MUST** be assembled in this direction

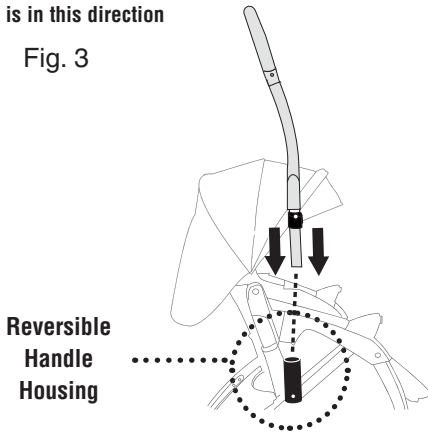

Reversible Handle Housing

Fig. 3A

NOTE: Make sure handle housing is facing upward before inserting handle

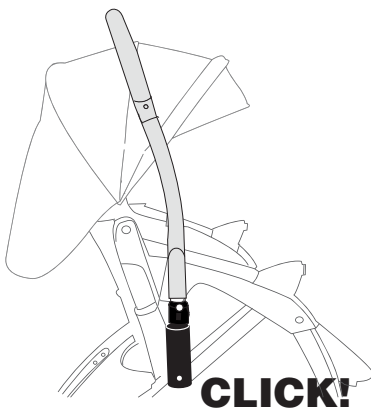
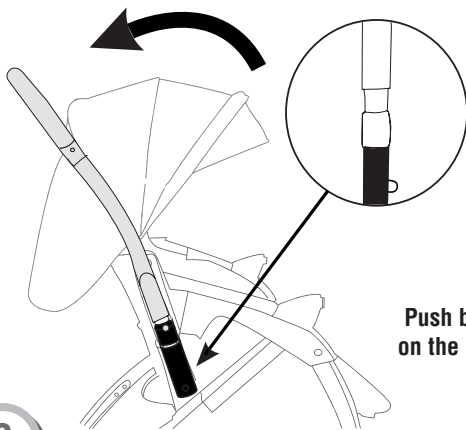

Fig. 3B

CLICK!



Push buttons located on the inside right/left handle

3

Attaching Reversible Handle

- Insert handle into the stroller handle housing located on the left / right side of the stroller frame (Fig. 3) until both sides “CLICK” (Fig. 3A) into a fully locked position (Fig. 3B).
- Make sure handle is fully secure by lifting upwards.

Customer Service gcs@deltachildren.com

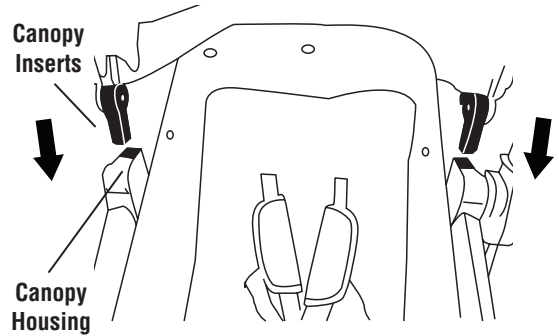
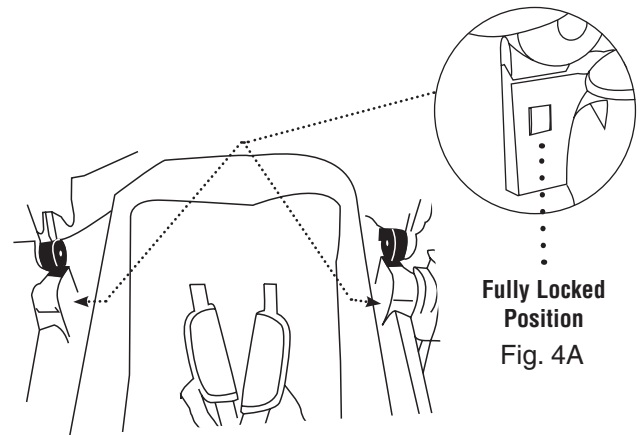

Fig. 4



Canopy Fully Attached

Fully Locked Position
Fig. 4A

4

Attaching Canopy

- To attach canopy: Push both sides of the canopy posts inserts into the canopy housing (Fig. 4) until they “CLICK” into a fully locked position (Fig. 4A).
- To remove canopy: Press in both release buttons located on the sides of the canopy housing, and lift upward.

Set Up and Use

Fig. 1

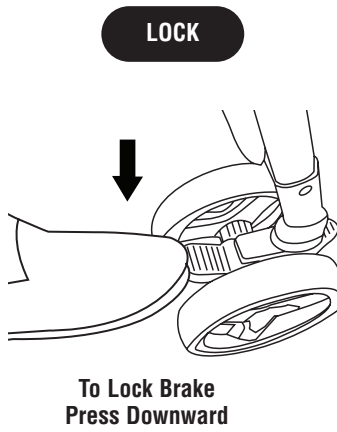

Fig. 2

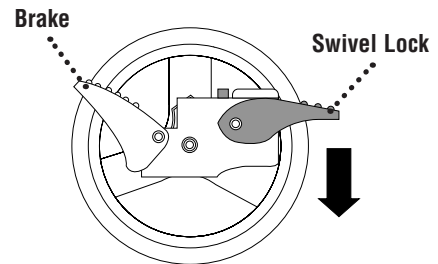
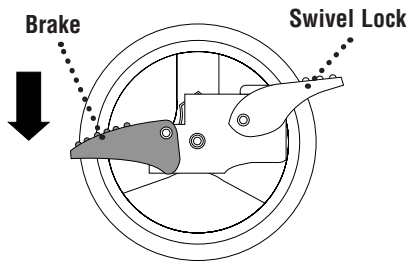
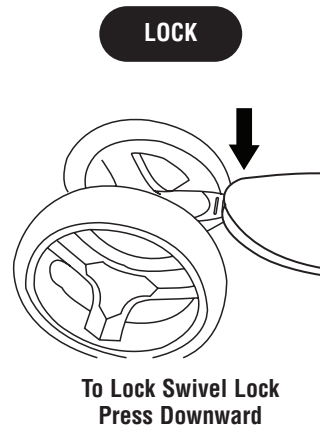

Fig. 1A

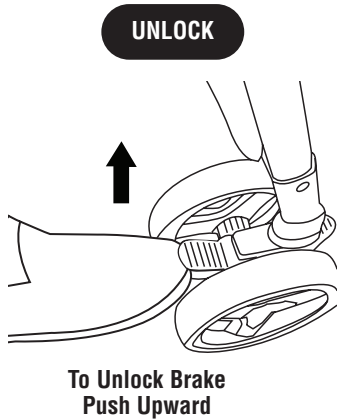
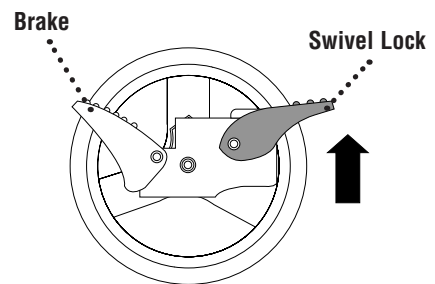
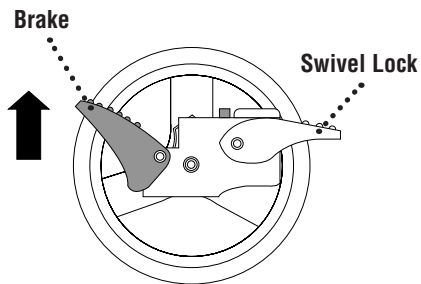
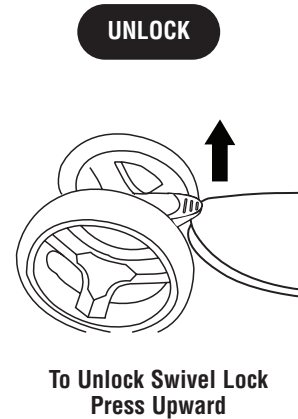

Fig. 2A



1

Brakes

- To lock brakes: Apply light downward pressure on the wheel brake located on the back of the wheel. (Fig. 1)
- To unlock brakes: Gently lift upward on the wheel brake located on the back of the wheel. (Fig. 1A)

2

Swivel Lock

- To lock: Apply light downward pressure on the swivel lock located on the front of the wheel. (Fig. 2)
- To unlock: Gently lift upward on the swivel lock located on the front of the wheel. (Fig. 2A)

All Wheels Have Both a Brake Lever and a Swivel Lock Lever

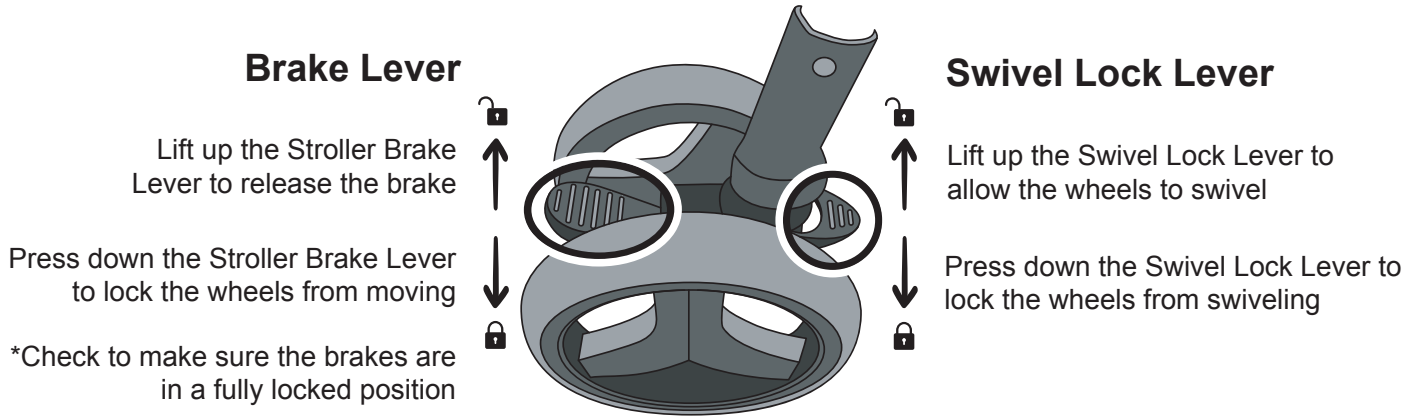

How to Setup Swivel Wheels for Proper Use of the Reversible Handle Stroller

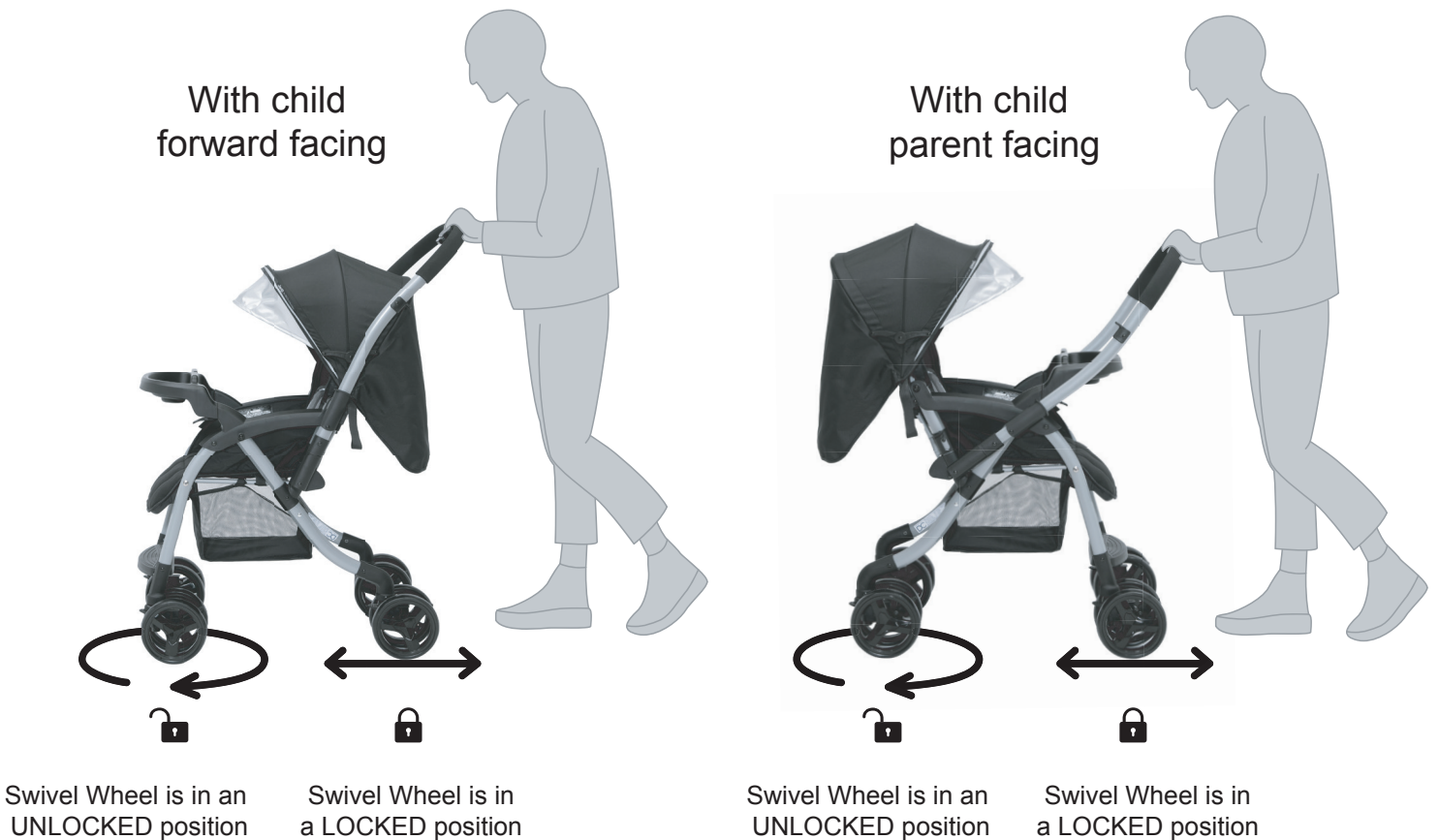

Set Up and Use

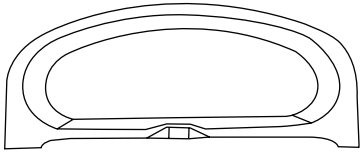

Fig. 3

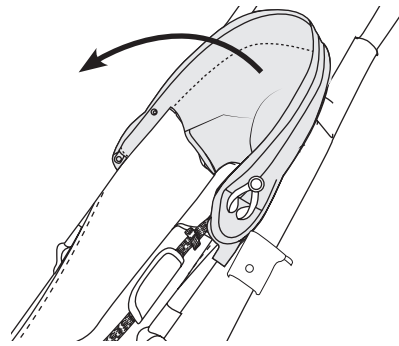

Fig. 4

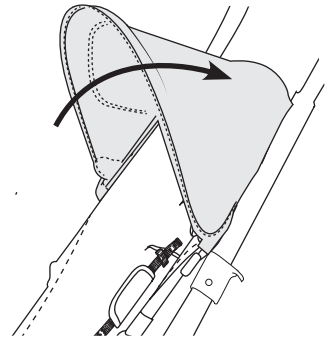

Fig. 4A

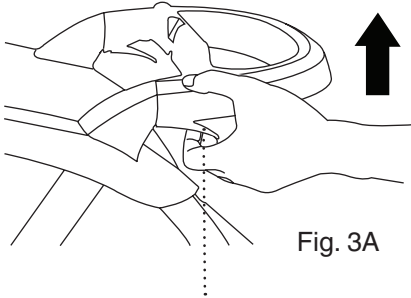

Fig. 3A

Release Buttons

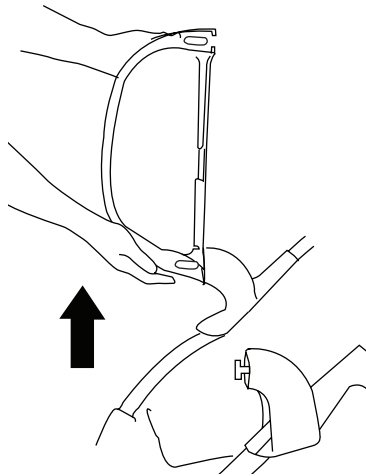

Fig. 3B

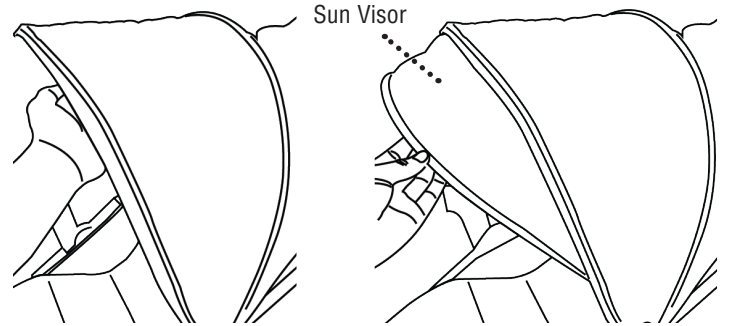

Fig. 4B

4

Canopy and Sun Visor Adjustment

- To open the canopy: Pull forward on the front edge of the canopy until fully opened. (Fig. 4)
- To close canopy: Rotate canopy backward until close. (Fig. 4A)
- To open the sun visor: Grab front edge of the sun visor under canopy and rotate forward until fully extended. (Fig. 4B)

3

Attaching and Removing Child Tray

- To attach child tray: First, rotate and align left and right side of child tray posts with the left and right side stroller tray posts. Slide left and right side child tray into left and right side stroller tray posts into a fully locked position. (Fig. 3) Check to make sure child tray is securely attached to the stroller by pulling upward on the child tray.
- To remove the child tray: Press the left and right release buttons located underneath the left and right side of the child tray (Fig. 3A), and pull upward on both sides to fully remove child tray. (Fig. 3B)

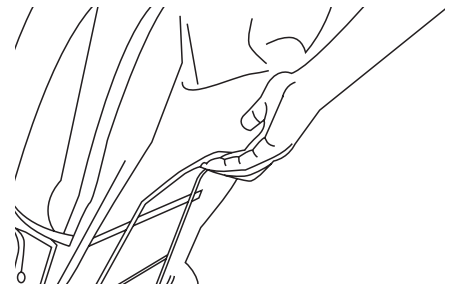

Fig. 5

5

Seat Back Recline Positioning

- Pull the bar located on the back of the seat upwards and rotate seat downward to recline seat. (Fig. 5)
- To return to an upright position: Push the seat upwards until it "CLICKS" into a locked position.

Setup and Use

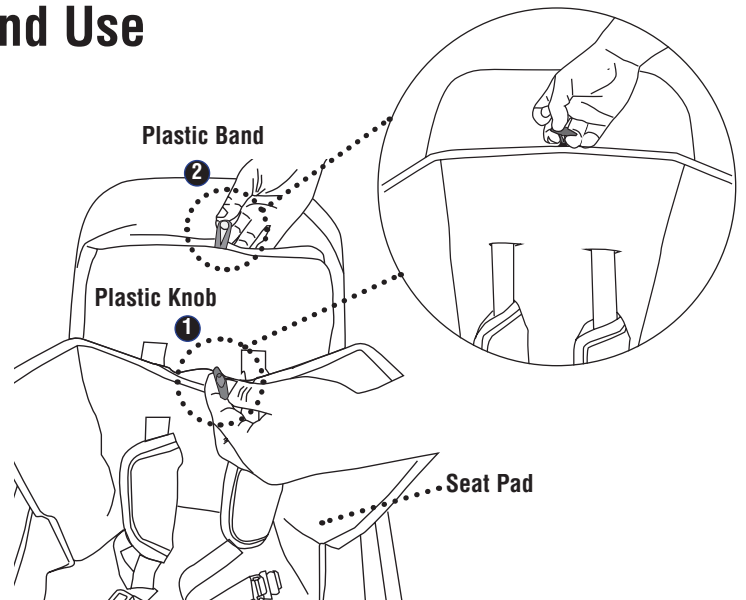
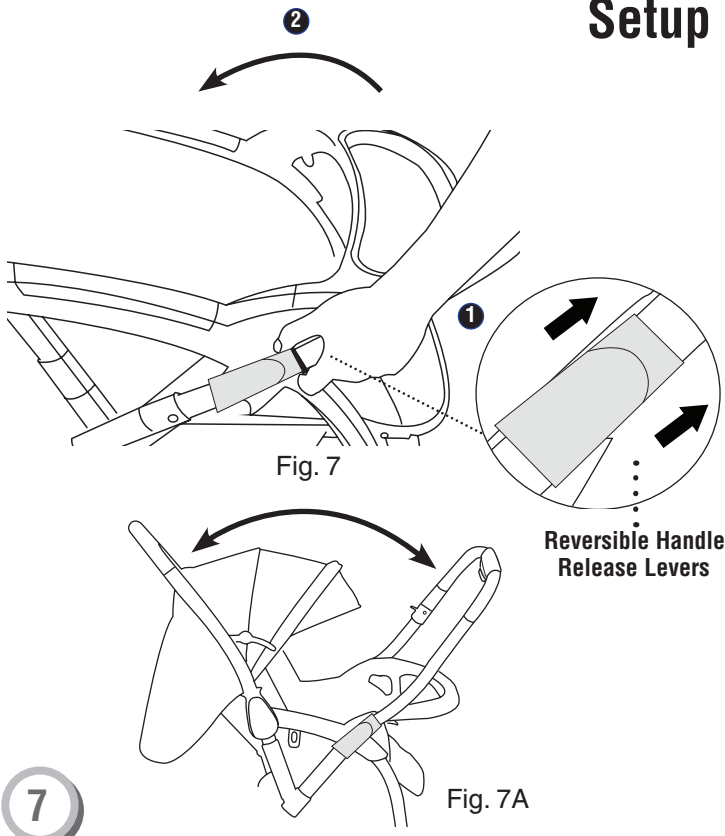

7

Adjusting Reversible Handle Into Forward Position

- First, slide both reversible handle release levers upward (Fig. 7) then, rotate handle to forward position until it “CLICKS” into a fully locked position (Fig. 7A).
- Make sure reversible handle is fully secure by lifting upwards.

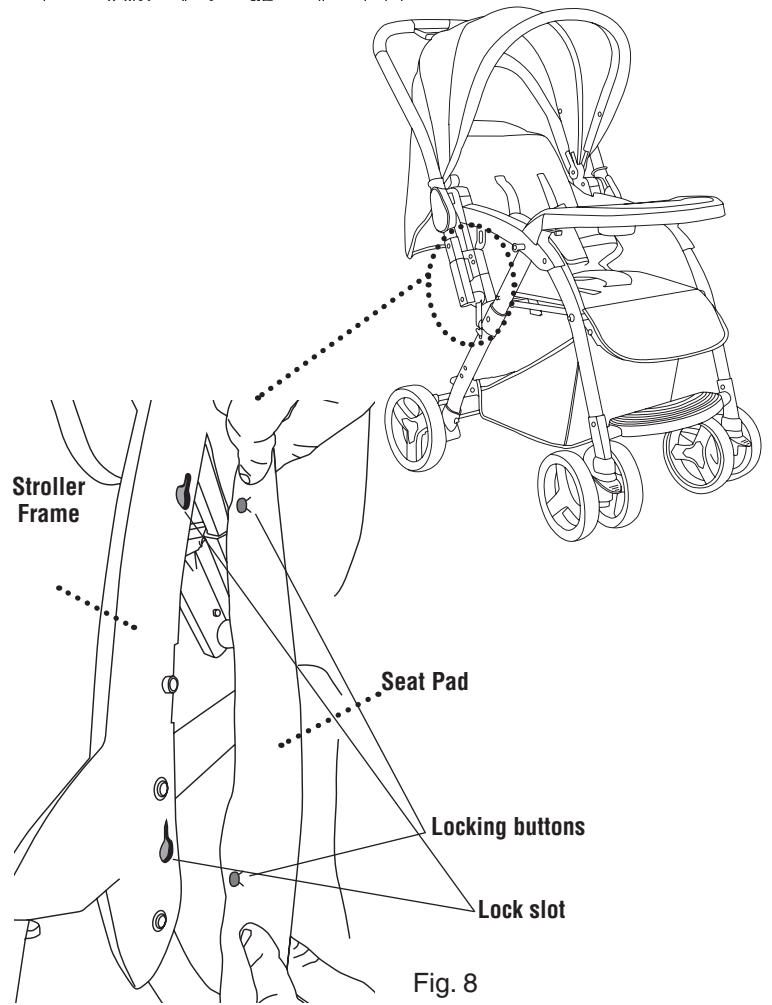

8

Securing Seat Pad

- Locate the plastic knob attached to the stroller head rest frame 1. Locate the plastic band attached to the seat pad head rest 2. Loop the plastic band to the plastic knob.
- Locate the 2 locking buttons on the stroller seat pad and snap to the lock slot of the stroller frame (Fig. 8). Repeat on the opposite side.

NOTE: When child is facing front (away from parent), you can lock the rear wheels for swivel for easy navigation

Turn

NOTE: When child is facing rear (towards parent), you can lock the two front wheels for easy navigation

Turn

Setup and Use

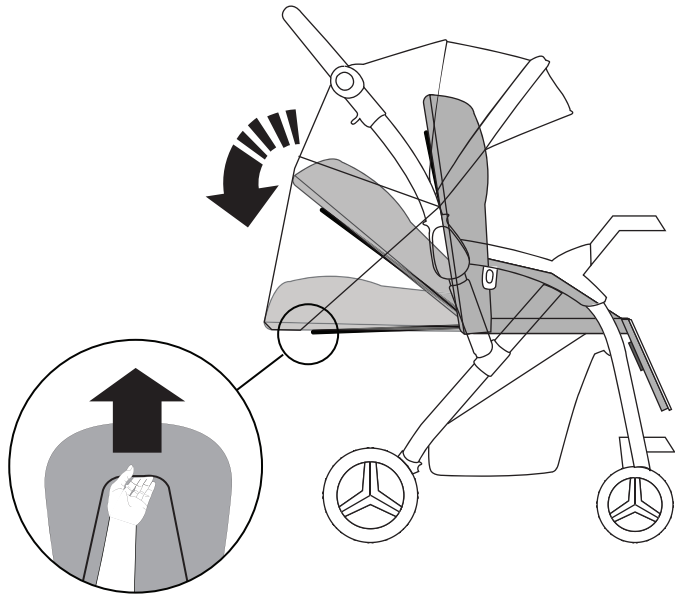

Fig. 9

9

Seat Back Recline Positioning

- Lift the recline bar located on the top center of the stroller seat upward and rotate seat downward into any of the three positions. (Fig. 9)

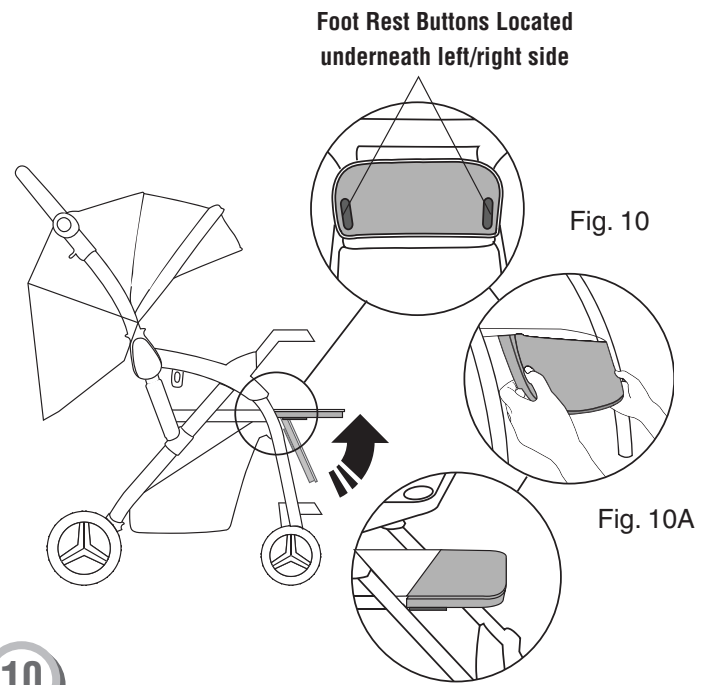

Fig. 10

Fig. 10A

10

Leg Rest Adjustment

- To adjust press both buttons located underneath left/right side of the leg rest. (Fig. 10) To adjust the positioning, rotate the leg rest upward and downward. (Fig. 10A)

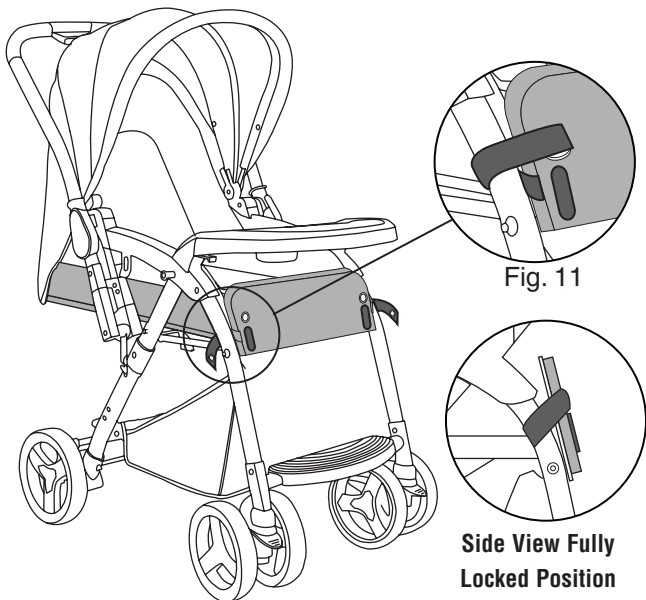

Fig. 11

Side View Fully Locked Position

11

Upright Leg Rest Positioning

- When using the leg rest in an upright position, make sure both side straps are looped around the stroller's side frame and fully secured with snaps onto the bottom leg rest. (Fig. 11)

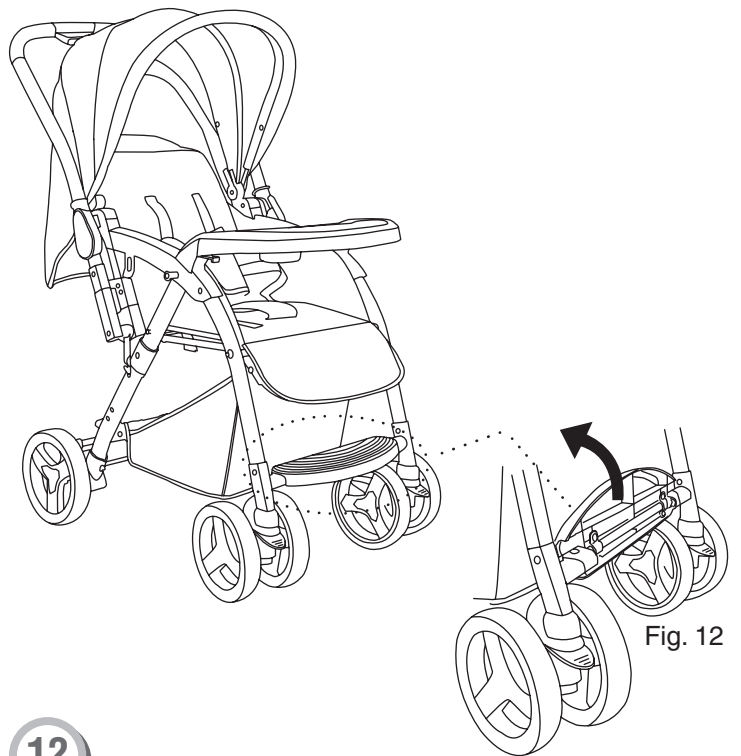

Fig. 12

12

Adjustable Foot Rest For Front Facing Reversible Handle

- Rotate the foot rest upward when using front facing handle.

Securing Child

Before Placing your Child in Stroller:

Close Canopy. Press both brake pedals down until they “click” into the locked position.

Make sure the brake pedals are pressed down completely.

Always set both brake pedals when parking the stroller.

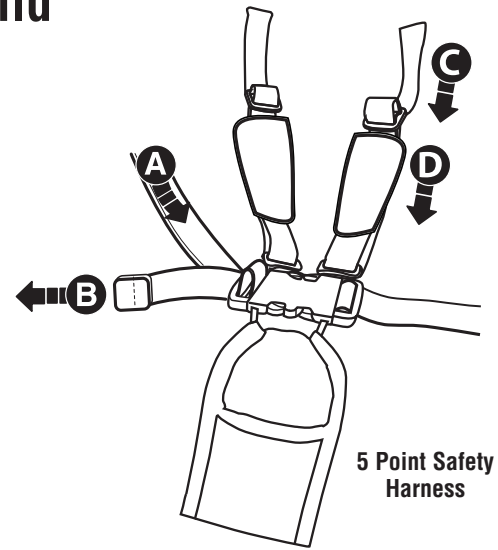
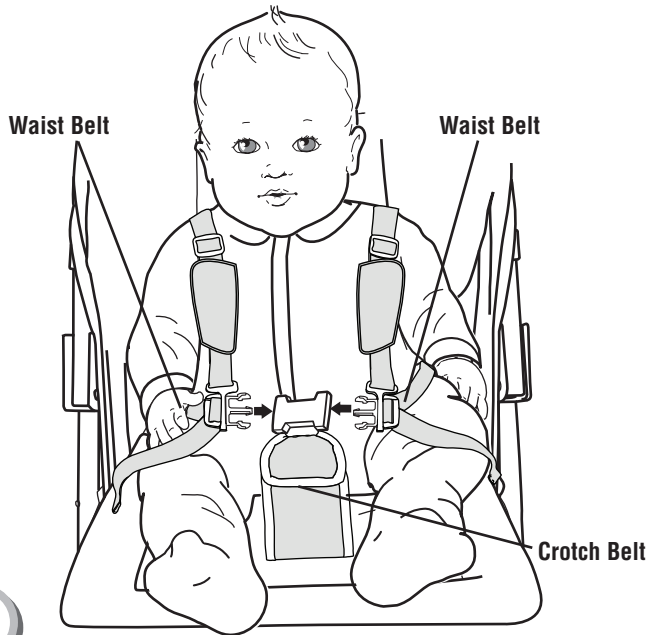

5 Point Safety Harness

TIGHTEN

1

Securing Child

- Place your child in the stroller. Position the crotch belt between your child's legs.
- Pull shoulder straps over child's arm and shoulder and fasten **both** strap ends to the restraint system.
- Fasten **both** waist belts to the buckle on each side of the crotch belt. Make sure you hear a “click” on both sides.
- Check to be sure the restraint system is securely attached by pulling it away from your child. The restraint system should remain attached.

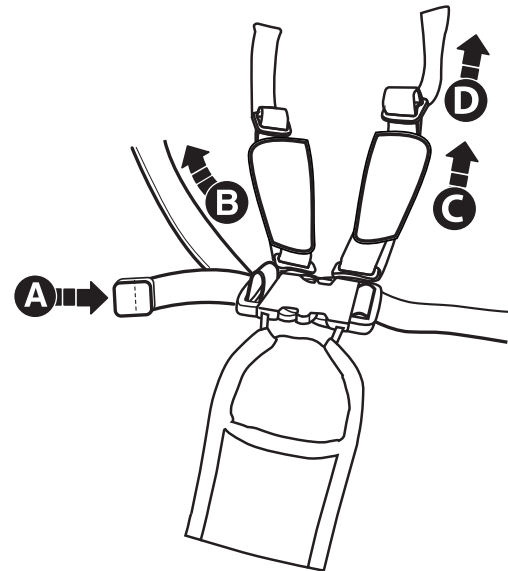

LOOSEN

3

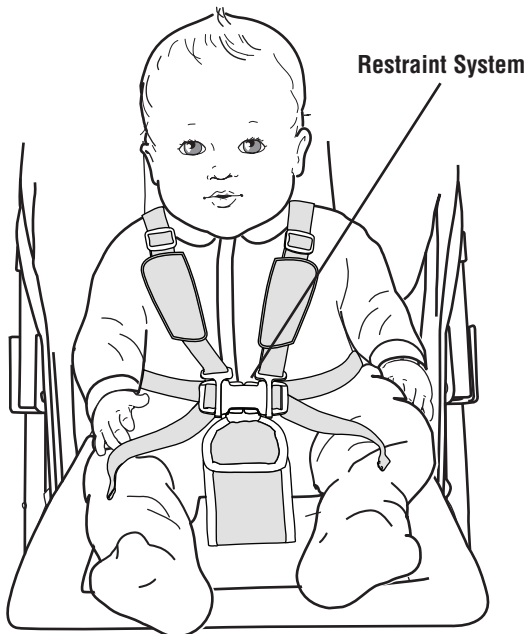

2

- Tighten each waist belt and shoulder strap so that the restraint system is snug against your child.
Please refer to the next section for instructions to tighten the waist belts.

To tighten the waist belts and shoulder straps:

- Feed the anchored end of a waist belt up through the buckle to form a loop **A**. Pull the free end of the waist belt **B**.
- Repeat this procedure to tighten the other waist belt.
- Feed the top end of the shoulder strap through the plastic stay to form a loop **C**. Pull the bottom end down to tighten the strap **D**.
- Repeat this procedure to tighten the other shoulder strap.

To loosen the waist belts and shoulder straps:

- Feed the free end of the waist belt up through the buckle to form a loop **A**. Enlarge the loop by pulling on the end of the loop toward the buckle. Pull the anchored end of the waist belt to shorten the free end of the waist belt **B**.
- Repeat this procedure to loosen the other waist belt.
- Feed the bottom end of the shoulder strap through the plastic stay to form a loop **C**. Pull the top end up to loosen the strap **D**.
- Repeat this procedure to loosen the other shoulder strap.

Please note: After adjusting the restraint system to fit your child, make sure you pull on it to be sure it is securely fastened.

Attaching Graco® and Evenflo® Car Seats

Graco® SnugRide® Click Connect™ and Evenflo® Nurture™ and Embrace™

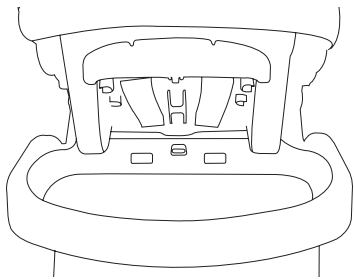

Back of Graco® Car Seat

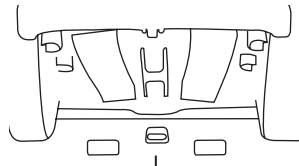

Graco® locked position - red locking tab clicks

Fig. 14B

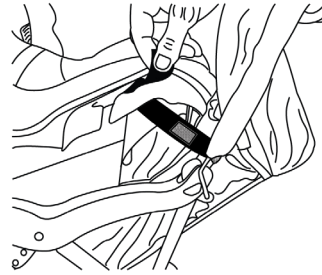
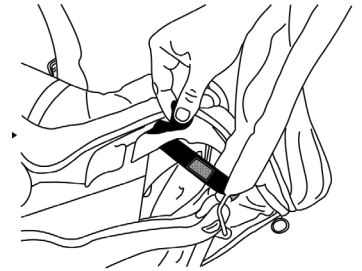

Fig. 14D



2

- Final step to secure the footrest side of car seat onto stroller, use the straps with velcro to secure seat onto stroller. (Fig. 14D). Check that car seat is securely attached by pulling up on the car seat. To remove, undo latches and unlock car seat from child tray.

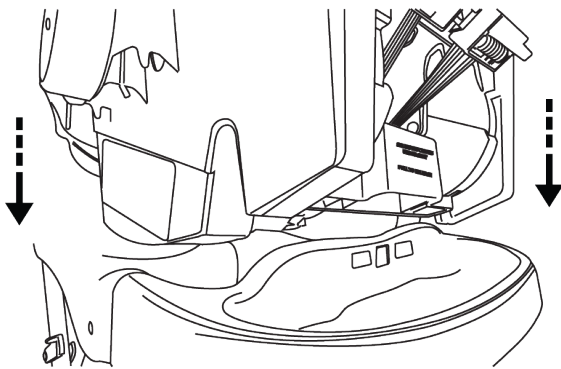
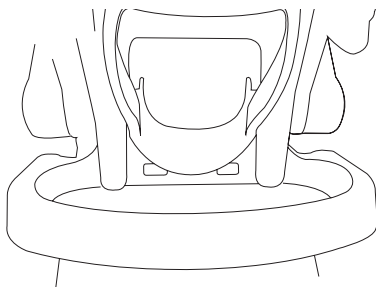
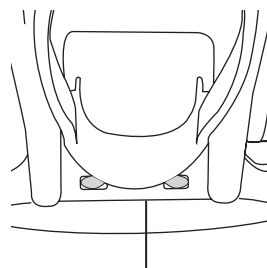

Fig. 14A



Back of Evenflo® Car Seat



Evenflo® locked position - grey locking tab clicks

Fig. 14C

1

Attaching Graco® and Evenflo® Car Seats-

Graco® SnugRide® Click Connect™ and Evenflo® Nurture™ and Embrace™

- To use the car seat feature: Lock back wheels and recline the back seat to its lowest position and fold canopy closed. Align car seat with child tray (Fig. 14A). Angle feet first, while lowering car seat into a locked position on the child tray. Both car seats lock in the center of the child tray. See locked positions for Graco® (Fig 14B) and Evenflo® (Fig 14C). Make sure car seat is fully fastened by pulling upward.

TO FOLD STROLLER:

Fig.1A

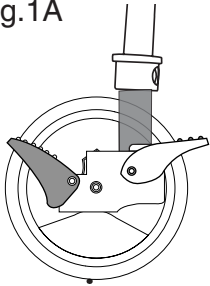
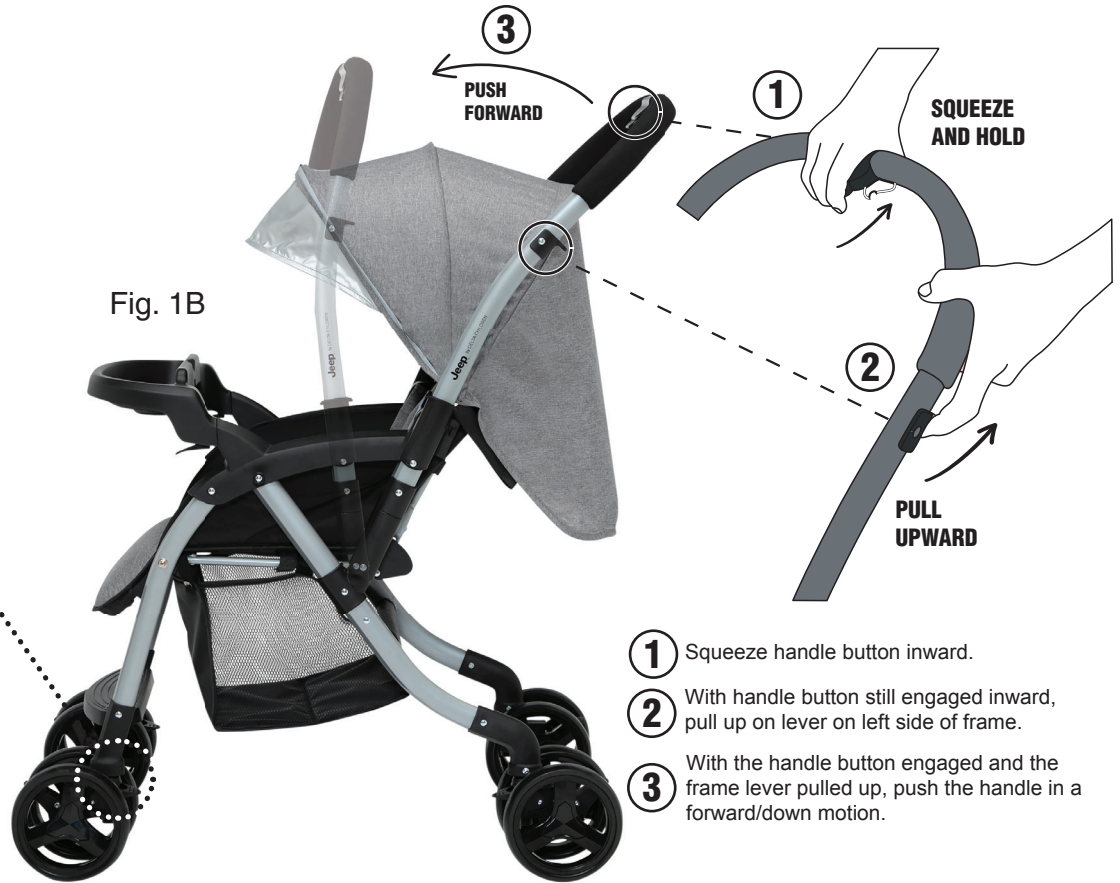

Fig. 1B



- 1 Squeeze handle button inward.
- 2 With handle button still engaged inward, pull up on lever on left side of frame.
- 3 With the handle button engaged and the frame lever pulled up, push the handle in a forward/down motion.

NOTE: STROLLER WILL NOT FOLD CORRECTLY WITHOUT FOLLOWING STEPS 1 & 2 AND PUSHING THE HANDLE FORWARD.

Fig. 1C

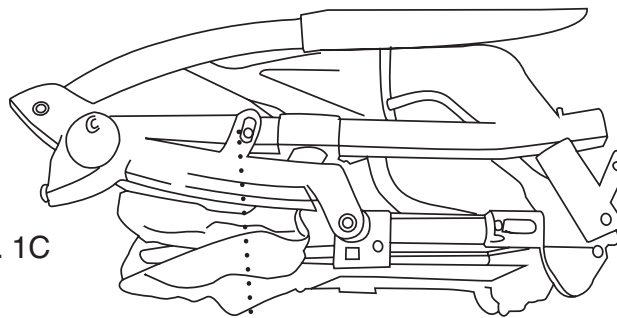

Locking Latch Clip

Folded Position

1

Folding the Stroller

- Make sure canopy is in it's fully closed position, then recline the seat to a fully reclined position.
- Make sure the front wheel brake is facing forward before folding the stroller. (Fig. 1A)
- Follow above diagram (Fig. 1B)
- Secure the stroller in the folded position by fastening the fold locking latch located on the right side of the stroller over the extended rivet on the lower frame tube. (Fig. 1C)

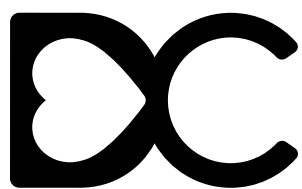

DELTACHILDREN

Delta Children's Products Corp.

114 West 26th Street
New York, NY 10001
www.DeltaChildren.com

follow us



@deltachildren