

DELTA♥CHILDREN

APOLLO JOGGER

INSTRUCTION MANUAL

ADULT ASSEMBLY REQUIRED
STYLES AND COLORS MAY VARY

11294

Fits Graco® SnugRide® Click Connect™ Infant Car Seat (not included)
Fits Evenflo® Embrace™ Select Infant Car Seat (not included)
Fits Evenflo® Nurture™ Infant Car Seat (not included)
Fits Britax® B-Safe 35™ Infant Car Seat (not included)



⚠ WARNING:
CHOKING HAZARD

Adult assembly required because of small parts. Keep assembly parts out of reach of children under 3 years.

Read all instructions BEFORE assembly and USE of product
KEEP INSTRUCTIONS FOR FUTURE USE.

This stroller is not from, sponsored or endorsed by Graco Children's Products Inc.

This stroller is not from, sponsored or endorsed by Evenflo Company, Inc.

This stroller is not from, sponsored or endorsed by Britax®

Customer Experience Center
email: gcs@DeltaChildren.com

www.DeltaChildren.com

DCP-IM-02142023-F1

WARNING

WARNING: Please follow all of these instructions to ensure the safety of your child.

Keep these instructions for future reference.

WARNING: Failure to follow these instructions could result in serious injury or death.

- Avoid serious injury from falling or sliding out. **ALWAYS** insure that the child is properly positioned by using the safety harness according to these instructions. **ONLY** children who have developed enough upper body control to sit without leaning forward can use the front seat in the upright position.
- **NEVER** leave children unattended.

WARNING: CHOKING HAZARD Adult assembly required because of small parts.

Keep (assembly parts) out of reach of children under 3 years.

WARNING: FALL HAZARD from tip over. Before running, jogging, or walking fast, **LOCK** the front wheel from swiveling.

CAUTION: This is a single occupant jogging stroller for one child only. The use of more than one child may cause an unstable condition which can injure your child. **DO NOT** place parcels, diaper bags or accessory items on jogging stroller as this can cause an unstable condition.

TO PREVENT INJURY

- Make sure all body parts are clear of the stroller when folding and unfolding.
- **DO NOT** place hot liquids in the cup holder. Hot liquids can burn your child.
- Before allowing the children near the stroller, be certain the stroller is fully erect and latched in the open locked position.
- The maximum weight that can be carried in the lower basket, child tray and parent tray each is 3 lbs (1.36 kg).
- Use of the stroller with children weighing more than 50 pounds (22.62 kg) or over 42 inches (106.7 cm) tall, may cause a hazardous unstable condition to the stroller.
- **NEVER** use the stroller on stairways or escalators.
- **NEVER** allow your stroller to be used as a toy.
- **NEVER** use the stroller in conjunction with bicycles, skateboards, roller skates, or in-line skates. Please discuss using the jogging stroller with your health care provider prior to jogging use. We recommend that the child occupant needs to be 6 months of age, at the minimum, before use of the stroller.

Product features and decorations may vary from the photo.

CARE AND MAINTENANCE

- To clean the stroller use a mild household soap with warm water on a sponge or clean cloth. Do not use bleach.
- Check your stroller for loose screws, worn parts, torn material or stitching on a regular basis. Replace or repair parts as needed, discontinue use of stroller if it should become damaged or malfunctions.

FLAT TIRE

The jogging stroller features bicycle air tires which could become flat. If you have a flat tire, use a standard bicycle hand air pump to inflate the tires. Inflate the tires 20-25 psi.

NOTE: The stroller air tires can be taken to a bicycle shop for flat tire repair.

DELTA CHILDREN

LIMITED MANUFACTURER WARRANTY

This Delta product is warranted to be free from defects for a period of 90 days from the date of purchase under normal use. If a product is defective during this period, we will at our option repair or replace the defective part or product. This limited warranty extends only to the original retail purchaser and is valid only when supplied with proof of purchase, or if received as a gift, when the registration is on file with Delta.

This limited warranty does not cover the following:

- Products purchased as floor models or samples.
- Items purchased on an “as-is” basis, as a second hand product, or as a resale product.
- Items purchased at a Final sale, a “Going out of Business” sale, or a Liquidation sale. This limited warranty gives you specific legal rights and you may also have other rights which vary from state to state.

This limited warranty gives you specific legal rights and you may also have other rights which vary from state to state.

TO REGISTER YOUR PRODUCT for important safety alerts and updates to your product please visit www.deltachildren.com

TO REPORT A PROBLEM, please log on to www.deltachildren.com and click the Consumer Care Tab, or contact us by email at gcs@DeltaChildren.com

Date of Purchase: _____ (you should also keep your receipt)

EXTENDED WARRANTY

DON'T MISS YOUR CHANCE TO BE COVERED FOR ALL OF LIFE'S MISHAPS!

With Delta's Extended Warranty, you're covered for mechanical failure from normal use or if your item stops working due to normal wear and tear, plus all those unexpected surprises.

2 YEARS OF PROTECTION

For Additional Information:

Simply visit our Website, register your product, and add the Extended Warranty

<https://www.deltachildren.com/pages/product-registration>

Extended Warranty only available in the following States: Arkansas, Colorado, Delaware, District of Columbia, Georgia, Idaho, Illinois, Indiana, Iowa, Kansas, Kentucky, Louisiana, Maryland, Michigan, Mississippi, Missouri, Nebraska, Nevada, New Hampshire, New York, North Carolina, North Dakota, Pennsylvania, Rhode Island, South Dakota, Tennessee, Utah, West Virginia

PARTS

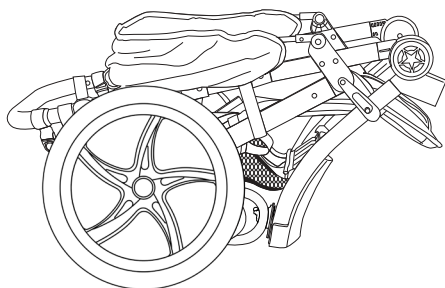

Stroller



Front Wheel Axle Lock Nuts

Part # 50218



Front Wheel Retainer Plate

Part # 50219

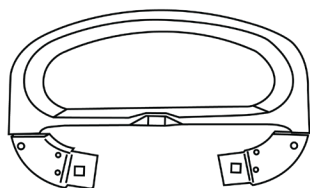

Child Tray

Part # 50174

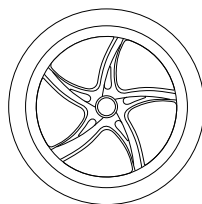

Front Wheel

Part # 50216

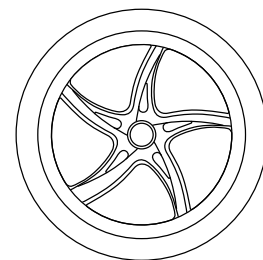
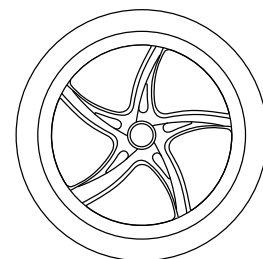

Rear Wheels

Part # 50226

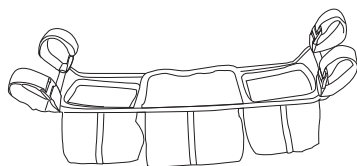

Parent Fabric Tray

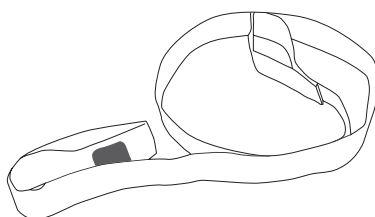

Safety Tether Strap

Part # 50238

ASSEMBLY

IMPORTANT! To ensure safe operation of your stroller, please follow these instructions carefully. Please keep these instructions for future reference.

IMPORTANT! Before assembly and each use, inspect this product for damaged hardware, loose joints, missing parts or sharp edges. NEVER use stroller if any parts are missing or broken. **IMPORTANT!** Adult assembly is required.

- Remove stroller from box. The front wheel, rear wheels, parent tray and child tray need to be installed prior to use.

FRONT WHEEL

WARNING: This front wheel utilizes a front wheel axle lock nut system. Please follow all of these instructions to ensure the safety of your child. Failure to follow these instructions could result in serious injury or death.

- To attach the front wheel, unfold stroller as described in the following section:
 1. Lean the stroller backwards so the rear axle frame is resting on a flat surface and the front wheel forks are pointing upward. (Fig. 1)
 2. Hook the front wheel axle into the front fork's slots (Fig.2)

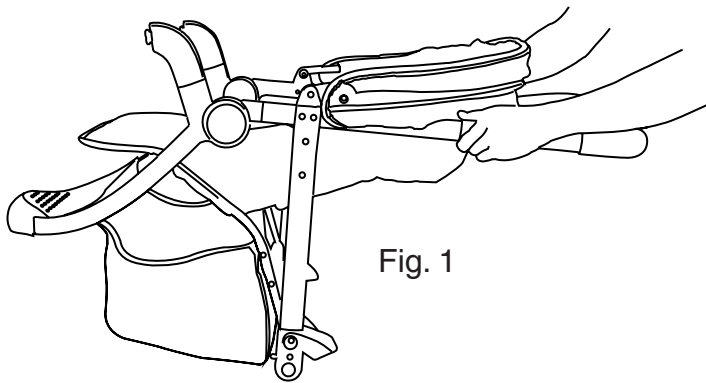

Fig. 1

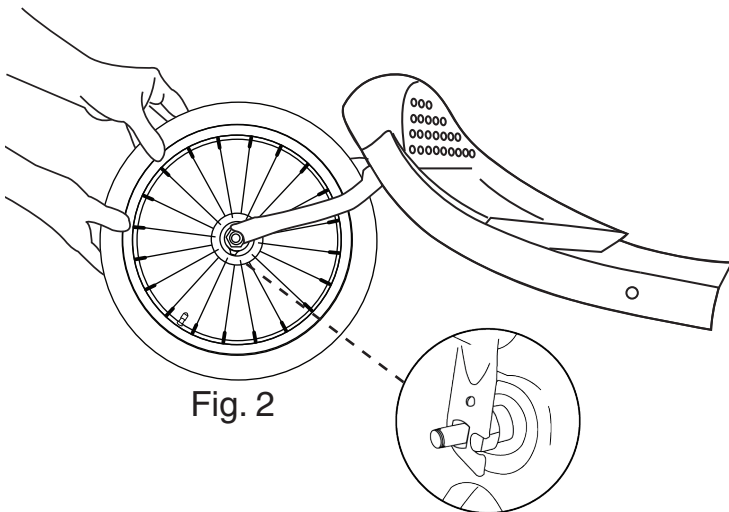

Fig. 2

3. Slide the retainer plate onto the front wheel axle. Be sure that the retainer plate's bent tab is facing towards the front fork slot. The bent tab on the retainer plate must be lined up with and trapped inside the front fork slot before tightening the wheel. (Fig. 3)

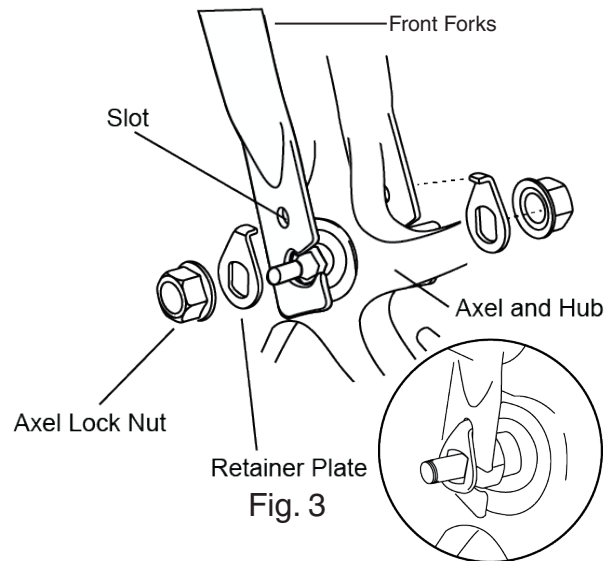

Fig. 3

4. Install the axle lock nuts and tighten with standard wrench, box or open end wrench. The front axle lock nut will be fully tightened and securely fastened when there is significant resistance to front fork. Repeat on other side. The wheel should be held tightly in place (Fig.4).

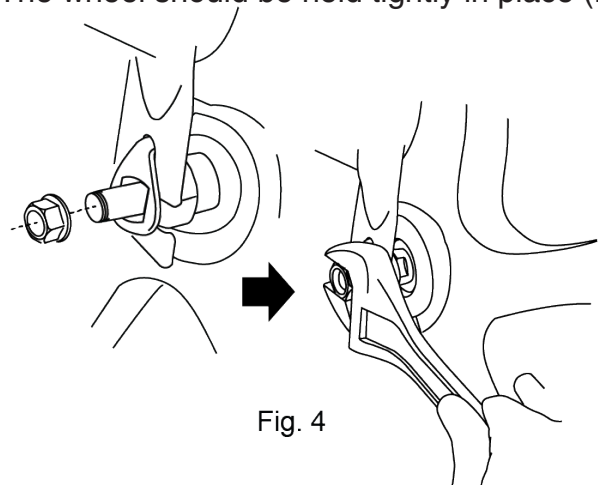

Fig. 4

ASSEMBLY

TESTING FOR PROPER WHEEL INSTALLATION

WARNING: FALL HAZARD: Wheel can detach and cause tip over. Pull on the wheel to assure it is securely attached and make sure the front swivel wheel is in a locked position during running, jogging or walking fast.

WARNING: ALWAYS check that both front axle lock nuts are fully tighten before each use to ensure that the front wheel is securely fastened to the frame.

5. Lift the front wheel off of the ground and sharply strike the top of the tire. (Fig. 5)
The wheel should not be loose or come off.

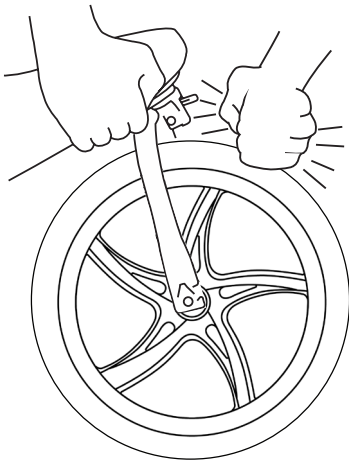

Fig. 5

REAR WHEEL

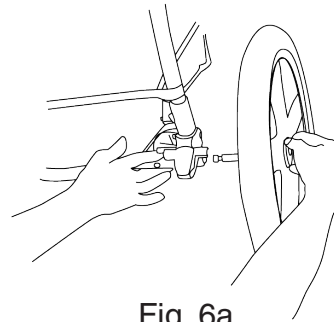

Fig. 6a

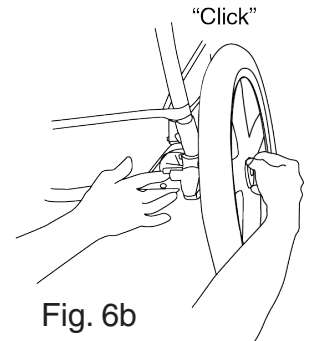

Fig. 6b

6. To attach the rear wheels, lay stroller on its side. Align back wheel axle to the stroller's rear wheel axle housing (Fig 6a). Push the back wheel axle inward until you hear a "click" (Fig. 6b). Once in a fully locked position, check to make sure back wheel is in a fully locked position by pulling outward. Repeat steps for other side back wheel. **NEVER** use stroller if any wheels are not in a fully locked position. Please contact our customer service department immediately at gcs@deltachildren.com for assistance.

PARENT TRAY

WARNING: The maximum weight that can be carried in the parent tray is 3 lbs (1.36 kg). **NEVER** place hot liquids in the parent tray as can cause serious burns and **NEVER** place more then 3lbs (1.36kg) in parent tray as may cause an unstable condition.

7. To attach parent fabric tray take velcro strap, wrap around jogger handle and put strap through clip (Fig. 7). Pull strap tight (Fig. 7A), and make sure velcro section is attached (Fig. 7B). Repeat 4X times on all sides until fabric tray is attached.

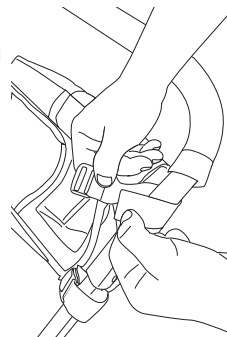

Fig. 7

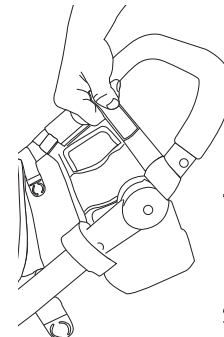

Fig. 7A

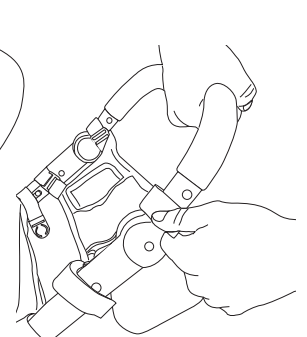

Fig. 7B

ASSEMBLY

CANOPY

CHILD TRAY

Open

Close

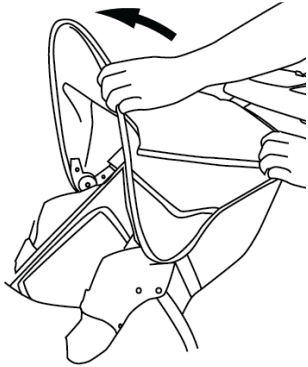

Fig. 8a

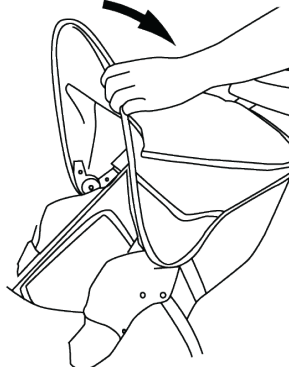
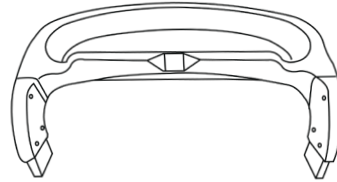

Fig. 8b

8. To open the canopy: pull forward on the front edge of the canopy until fully opened. (Fig. 8a)
To close canopy: push backward on front edge until canopy is all the way collapsed. (Fig. 8b)

Fig. 10



9. To attach the child tray: Rotate and align left and right side of child tray posts with the left and right side stroller tray posts. Press left and right side child tray posts into left and right side stroller tray posts into a fully locked position. Press left side child tray button and snap child tray onto stroller tray posts. Release button to lock child tray onto stroller (Fig.9). Repeat on right side of child tray. Check to make sure the child tray is securely attached to the stroller by pulling upward on the child tray.



Fig. 10a

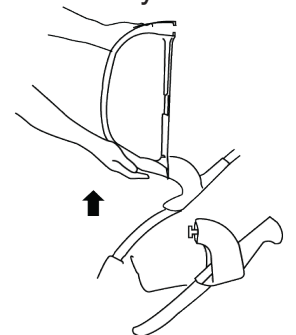

Fig. 10b

11. To remove the child tray: Press the right and left release buttons and pull upward on child tray. (Fig 11).

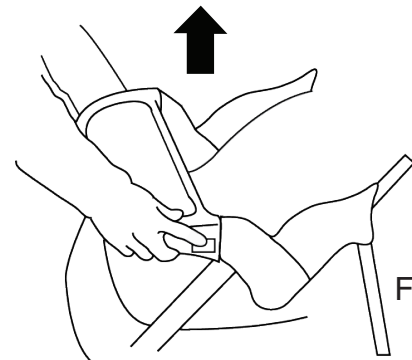

Fig. 11

SETUP & USE

BRAKES

WARNING: Always lock brakes when not in use on a hill or incline as stroller may roll away or slide down the hill.

WARNING: Never leave child unattended in stroller.

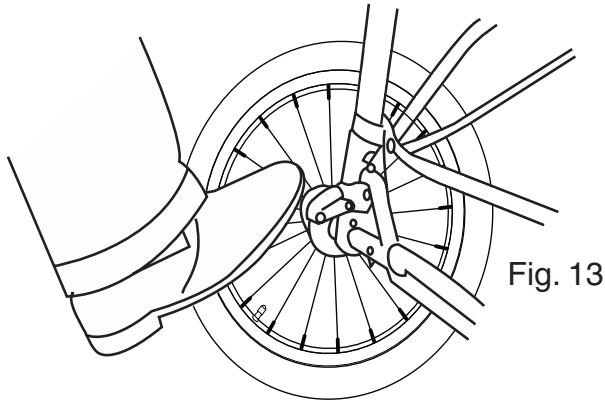

13. To lock brakes, press downward on brake lever located on each rear wheel. Please note in order to line up the break tab with brake tab slots stroller may need to be moved forward or backwards slightly. (Fig. 14) Check to make sure the brakes are in a fully locked position, so stroller will not move when pushed. To release breaks, gently push up on the brake lever.

SECURING CHILD

Before Placing your Child in Stroller:

Close Canopy. Press both brake pedals down until they “click” into the locked position.

Make sure the brake pedals are pressed down completely.

Always set both brake pedals when parking the stroller.

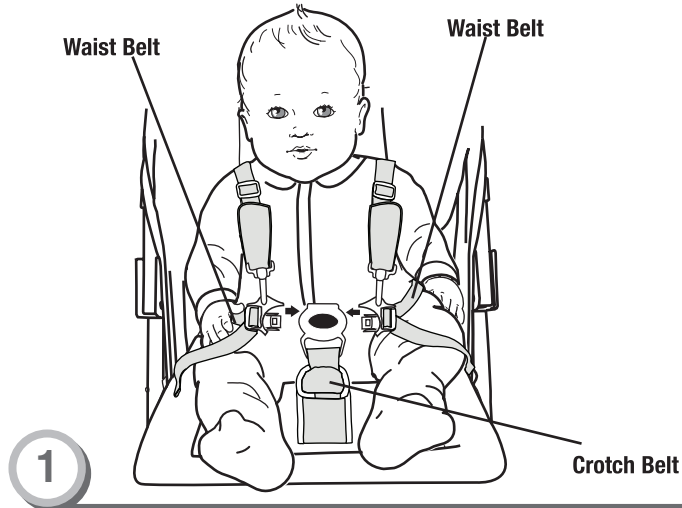
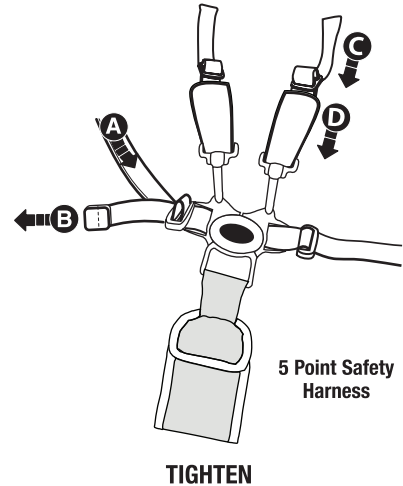

Securing Child

- Place your child in the stroller. Position the crotch belt between your child’s legs.
- Pull shoulder straps over child’s arm and shoulder and fasten **both** strap ends to the restraint system.
- Fasten **both** waist belts to the buckle on each side of the crotch belt. Make sure you hear a “click” on both sides.
- Check to be sure the restraint system is securely attached by pulling it away from your child. The restraint system should remain attached.

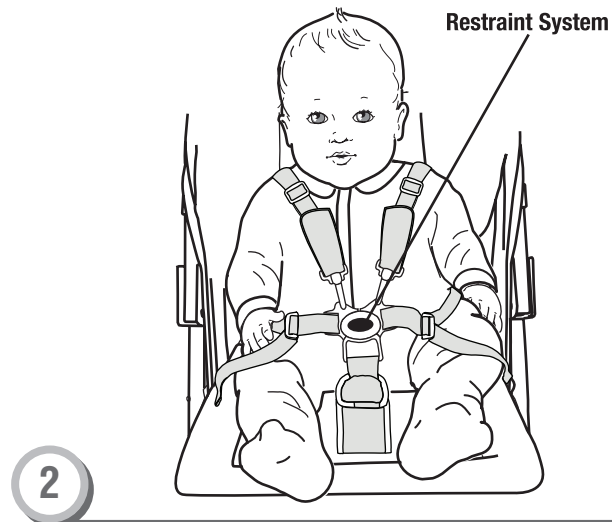
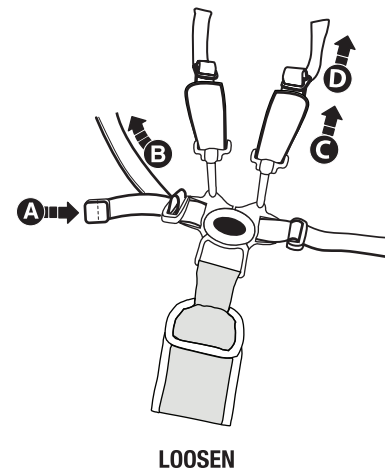

- Tighten each waist belt and shoulder strap so that the restraint system is snug against your child.
Please refer to the next section for instructions to tighten the waist belts.

3

To tighten the waist belts and shoulder straps:

- Feed the anchored end of a waist belt up through the buckle to form a loop **A**. Pull the free end of the waist belt **B**.
- Repeat this procedure to tighten the other waist belt.
- Feed the top end of the shoulder strap through the plastic stay to form a loop **C**. Pull the bottom end down to tighten the strap **D**.
- Repeat this procedure to tighten the other shoulder strap.

To loosen the waist belts and shoulder straps:

- Feed the free end of the waist belt up through the buckle to form a loop **A**. Enlarge the loop by pulling on the end of the loop toward the buckle. Pull the anchored end of the waist belt to shorten the free end of the waist belt **B**.
- Repeat this procedure to loosen the other waist belt.
- Feed the bottom end of the shoulder strap through the plastic stay to form a loop **C**. Pull the top end up to loosen the strap **D**.
- Repeat this procedure to loosen the other shoulder strap.

Please note: After adjusting the restraint system to fit your child, make sure you pull on it to be sure it is securely fastened.

SETUP & USE

SEAT BACK RECLINE

16. Squeeze both sides on cord housing and pull away to recline seat. (Fig 16a). To return to an upright position, hold bottom cord loops while squeezing cord housing and move cord housing upwards towards the backseat. (Fig 16b)

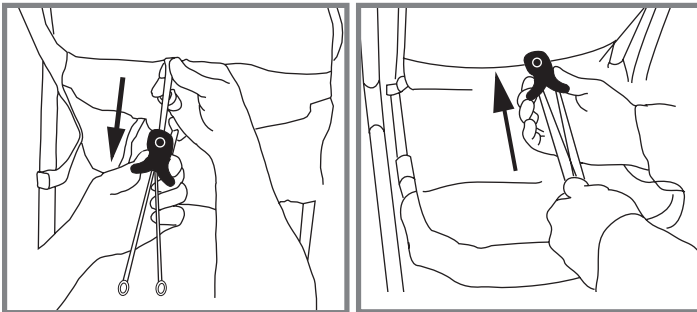

RECLINE
Fig. 16a

UPRIGHT
Fig. 16b

JOGGING WITH YOUR STROLLER

17. When you are jogging with your child, use the following safety features:

- **LOCK THE FRONT SWIVEL WHEEL BY PUSHING UPWARD ON THE FRONT SWIVEL WHEEL LOCK PUTTING THE FRONT WHEEL INTO A STRAIGHT POSITION.** (Fig. 17)
- **SAFETY TETHER STRAP:** Always connect the safety tether strap to either right or left wrist when jogging. The tether strap will keep the stroller from moving or rolling away in the event that you trip or stumble while running. (Fig. 17a) The safety tether strap must remain connected to the rear lower frame cross member at all times. The safety tether strap can be stored on the left or right side of the stroller with the Velcro attachment, when not in use. (Fig 17b).
- **NOTE:** Do not remove the safety tether strap from the bottom wheel axle as it is intended to prevent the stroller from tipping backwards if the stroller happens to move or roll away in the event that you trip or stumble.

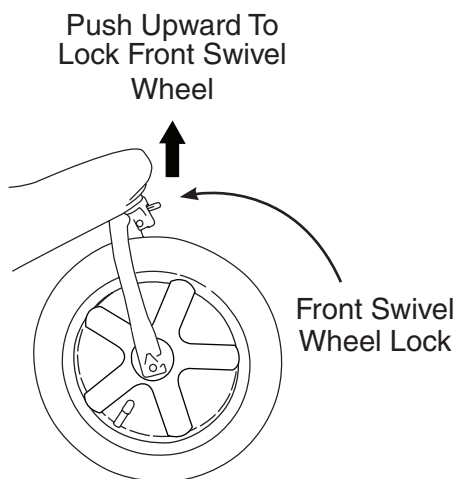

Fig. 17

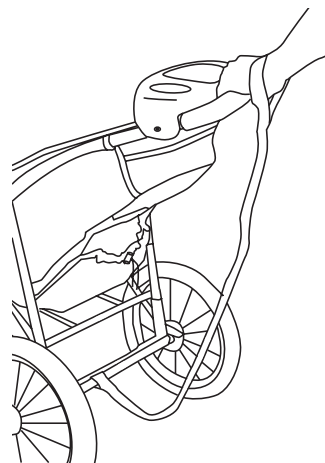

Fig. 17a

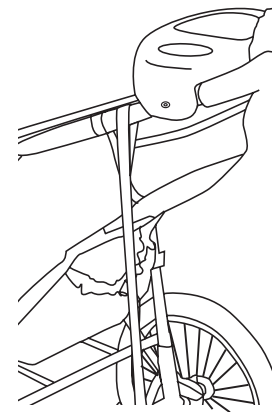

Fig 17b

HOW TO ATTACH CAR SEATS

For Graco and Evenflo Car Seats

(Car Seats are NOT included)

(Car Seats DO NOT need adapter - both car seats lock in the center of the child tray)

18. To use the car seat feature, lock back wheels and recline the back seat to its lowest point and fold canopy close. Turn and lock grey latches (Fig 18). Align car seat as shown in Fig 18a. Angle feet first, while lowering car seat into a locked position on the child tray. Both car seats lock in the center of the child tray. See locked positions for Graco (Fig 18b) and Evenflo (Fig 18c). Make sure car seat is fully fastened by pulling upward.

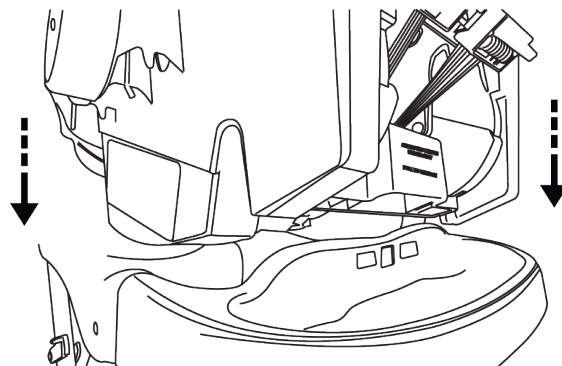

Fig. 18a

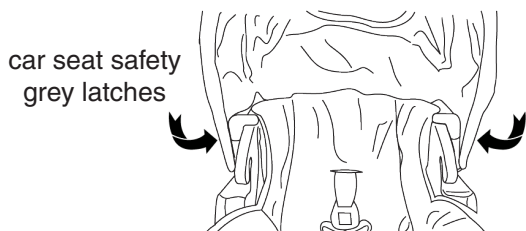
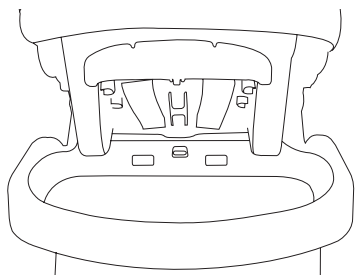
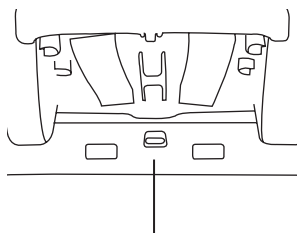

Fig. 18



Back of **Graco**
Car Seat



Graco locked position -
red locking tab clicks

Fig. 18b

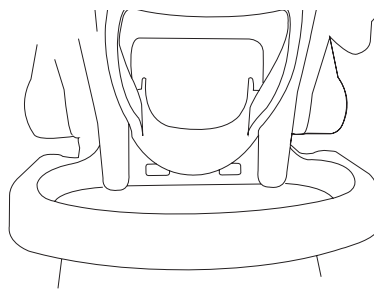

Back of **Evenflo**
Car Seat

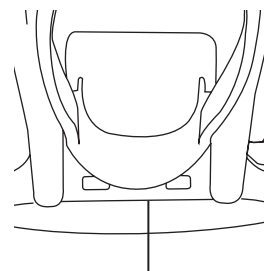

Evenflo locked position -
grey locking tab clicks

Fig. 18c

19. Final step to secure the footrest side of car seat onto the stroller, use the straps with velcro to secure seat onto stroller. (Fig 19). Check that car seat is securely attached by pulling up on the car seat. To remove, undo latches and unlock car seat from child tray.

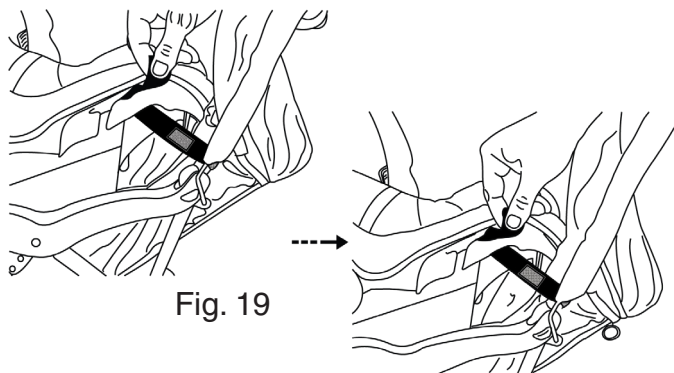

Fig. 19

HOW TO ATTACH CAR SEATS

For Britax Car Seat

(Car Seat is NOT included)

(Car Seat NEEDS **Britax Adapter*** to lock in the stroller's slots. ***Britax Adapter** is sold separately.)

20. Locate the Britax left / right adapter. They are labeled on the inside (L This Side Facing In) and (R This Side Facing In) (Fig. 20). Line up the bottom of Britax right side adapter (R This Side Facing In) with stroller arm post labeled "R" (Fig. 20a). Insert Britax adapter into stroller right arm post (Fig. 20b). Make sure release button is securely fastened into right side slot by pulling upward to make sure Britax adapter stays in place. Repeat with left side Britax adapter.

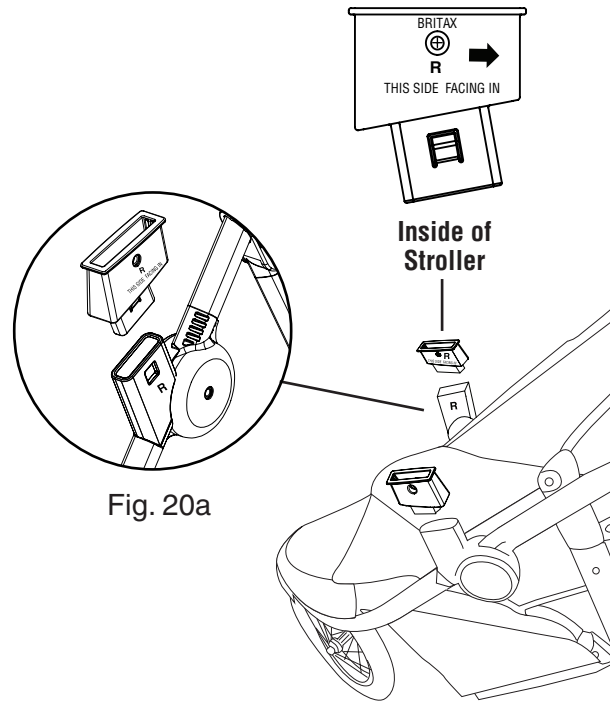
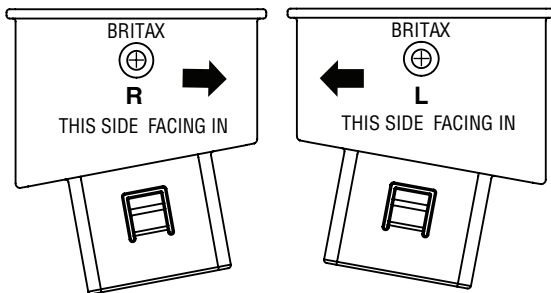
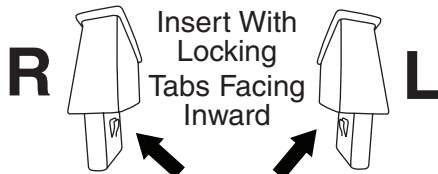

Fig. 20a



Inner Side of
Adapters

Fig. 20



Correct Placement
When Facing Into Stroller

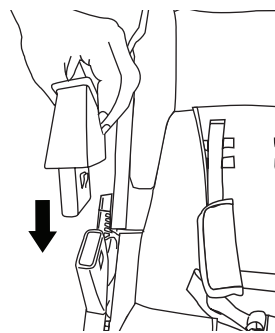
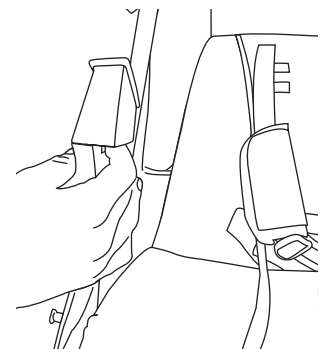

Fig. 20b



HOW TO ATTACH CAR SEATS

For Britax Car Seat

(Car Seat is NOT included)

(Car Seat NEEDS **Britax Adapter*** to lock in the stroller's slots. ***Britax Adapter** is sold separately.)

21. To attach Britax B-Safe 35 car seat, line up foot end of car seat toward stroller (Fig. 21). Glide car seat into Britax attachments. Make sure car seat is locked in place by pulling upward on car seat. Car seat is secure once both side lock tabs have "clicked" into place and car seat does not lift up. (Fig. 21a) To remove car seat, lift the back lever located on the back of the car seat and lift car seat upward to fully remove.

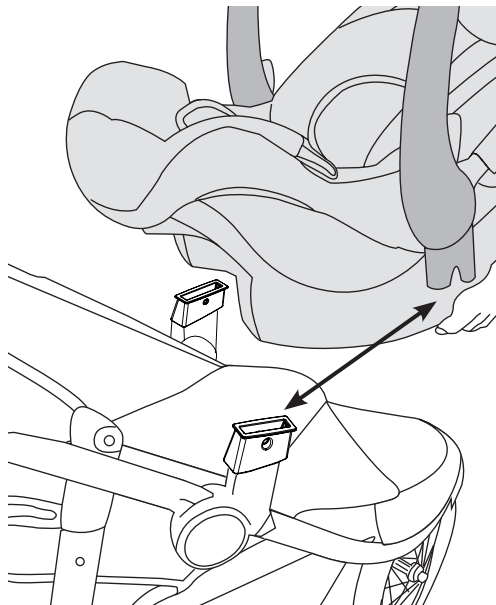

Fig. 21

22. Final step to secure the footrest side of car seat onto the stroller, use the straps with velcro to secure seat onto stroller. (Fig 22). Check that car seat is securely attached by pulling up on the car seat. To remove, undo latches and unlock car seat from child tray.

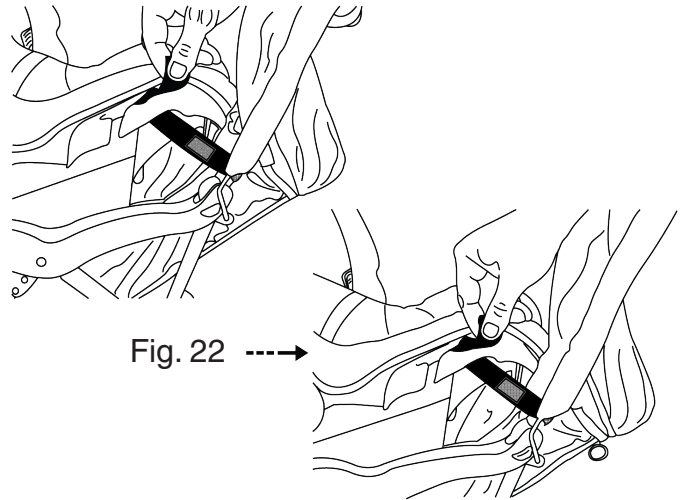
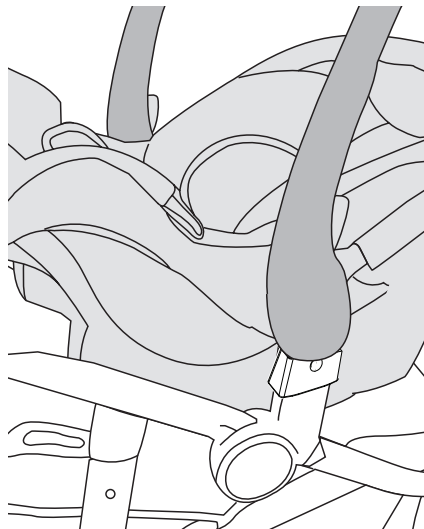

Fig. 22 ----->



Car seat will "CLICK" when locked in place.

Fig. 21a

HOW TO ATTACH CHICCO CAR SEATS

(Car Seat is NOT included)

(Car Seat NEEDS **Chicco Adapter*** to lock in the stroller's slots. *Chicco Adapter is sold separately.)

20. To use Chicco Keyfit 30 Car seat first, lock the back wheels, close the canopy as described in the canopy section (Pg. 10, Fig. 10). Recline seat by squeezing both sides of cord housing as described in seat back positioning section (Please see Page 12, Fig. 11) remove child tray (Please see Page 10, Fig. 8C) and child tray attachment arms. Press the release buttons located on the inner side of stroller arm. Press release button and pull upward at the same time until tray attachment arm is released (Fig. 13).

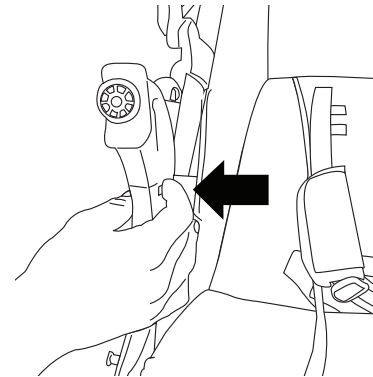

Fig. 13

21. Locate the Chicco left / right adapter. They are labeled on the inside (L This Side Facing In) and (R This Side Facing In). Line up the bottom of Chicco right side adapter (R This Side Facing In) with stroller arm post labeled "R" (Fig. 13A). Insert Chicco adapter into stroller right arm post (Fig. 13B). Make sure release button is securely fastened into right side slot by pulling upward to make sure Chicco adapter stays in place. Repeat with left side Chicco adapter.

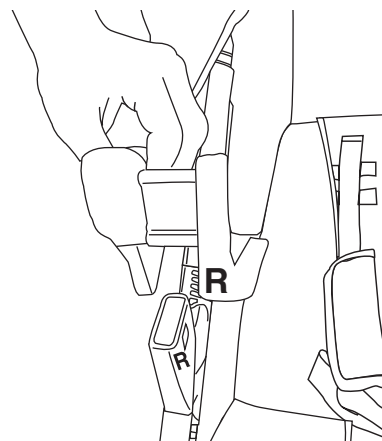
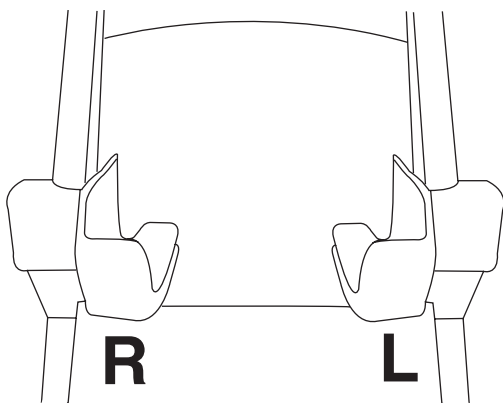

Fig. 13A



Fig. 13B



Correct Placement
When Facing Into Stroller

Right Side
Front View

Left Side
Front View

Insert With Locking
Tab Facing Inward

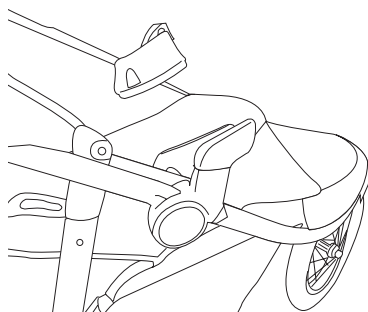

Chicco Car Seat
Adapters Attached
To Stroller

HOW TO ATTACH CHICCO CAR SEATS

(Car Seat is NOT included)

(Car Seat NEEDS **Chicco Adapter*** to lock in the stroller's slots. ***Chicco Adapter** is sold separately.)

22. To attach Chicco car seat, line up foot end of car seat toward stroller (Fig. 13C). Slide car seat into Chicco adapters. Make sure car seat is locked in place by pulling upward on car seat. Car seat is secured when both side lock tabs have "clicked" into place and car seat does not lift up. (Fig. 13D) To remove car seat, lift the back lever located on the back of the car seat and lift car seat upward to fully remove.

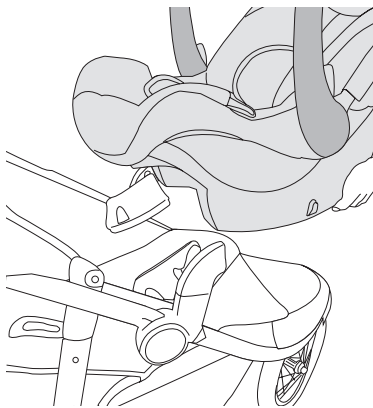

Fig. 13C

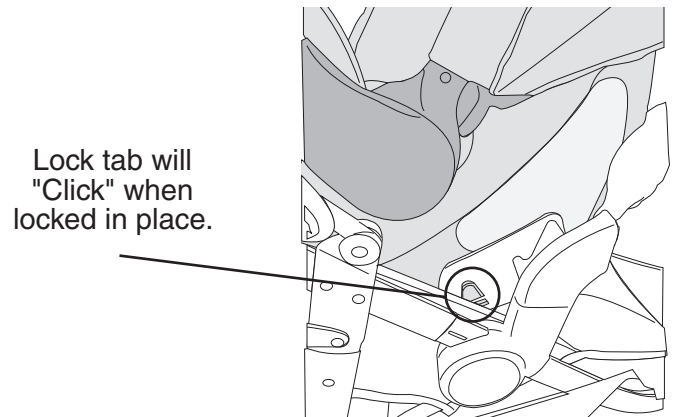

Fig. 13D

23. Final step is to secure the car seat to the stroller using the straps with velcro. (Fig. 13E)

- The top strap is to secure Graco, Chicco, and Evenflo car seats only. **A**
- The lower velcro strap is to secure Britax car seats only. **B**

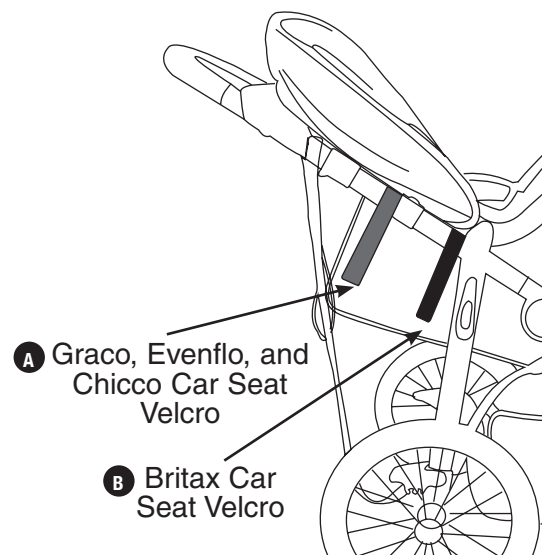

Fig. 13E

Secure the footrest side of car seat onto the stroller, use the straps with velcro to secure seat onto stroller. (Fig. 13F).

Check that car seat is securely attached by pulling up on the car seat. To remove, undo latches.

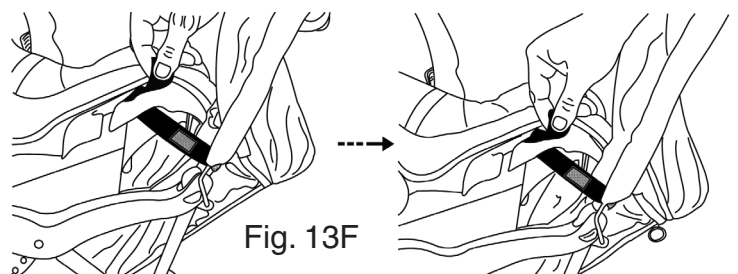

Fig. 13F

STORAGE

TO FOLD STROLLER

WARNING: Care must be taken when folding and unfolding the stroller to prevent finger entrapment.

23. Close the canopy as described in the canopy section (Fig 8-9). Recline seat to its lowest position by releasing buckle as described in seat back positioning section (Fig 16a).
- The stroller is folded by simultaneously pulling each trigger fold located on right and left handle above the canopy (Fig. 23). When the fold latches are released, the handle will begin to rotate and lower toward the floor.

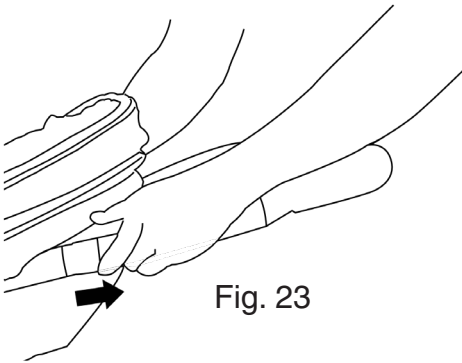

Fig. 23

- Release the fold buttons and move handle downward until the stroller is completely folded. The stroller is in a fully locked position when the locking fold latch is locked over the “T” post, located on the right side of the stroller (Fig. 23a).

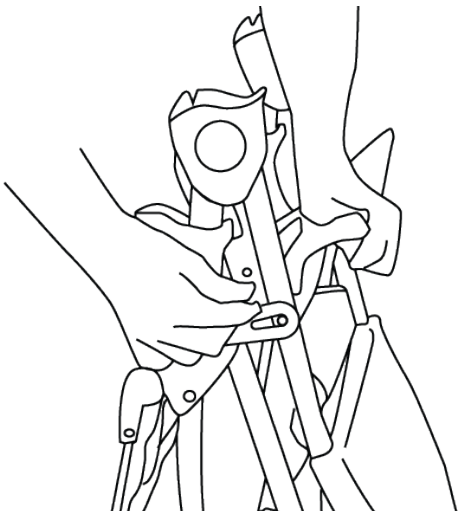

Fig. 23a

TO UNFOLD STROLLER

24. Place the stroller on the ground with all three wheels touching the ground. Release the locking folding latch, which is located on the right side. (Fig. 24)

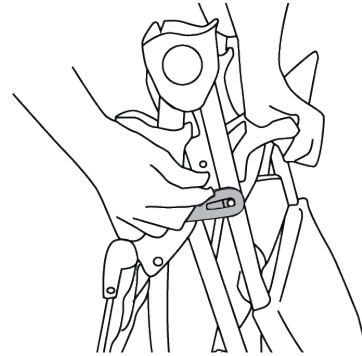

Fig. 24

- Lift up on the stroller handle with both hands until the stroller frame is in a fully opened and locked open position. (Fig. 24a) The stroller is in a fully locked position when both side handle latches are in a fully locked position. Prior to placing your child into the stroller, test to make sure both latches are fully engaged and fully locked.

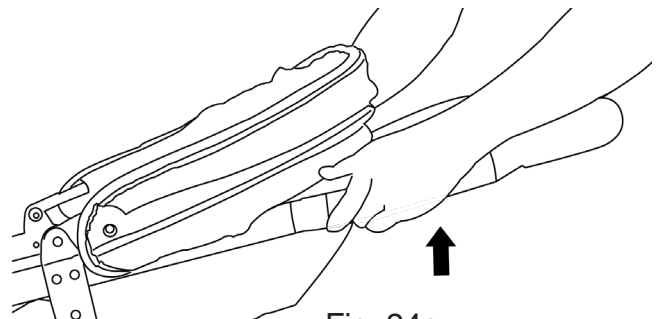
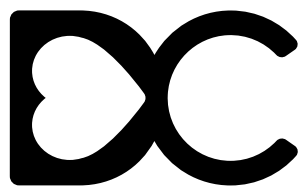

Fig. 24a



DELTACHILDREN

Delta Children's Products Corp.
114 West 26th Street
New York, NY 10001
gcs@DeltaChildren.com
www.DeltaChildren.com

follow us



@deltachildren