

HG

SUPER SKUB HYDRA



SPARE PARTS LIST Year 1996 - 2013

Updated 27-04-2015

Survey



Page 2

Page 3



Page 4

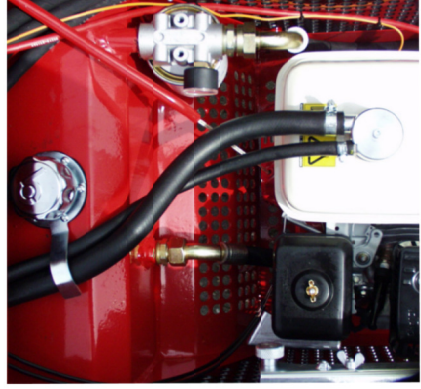

Page 5

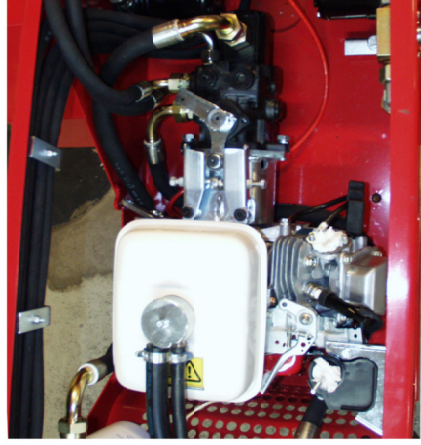

Page 6

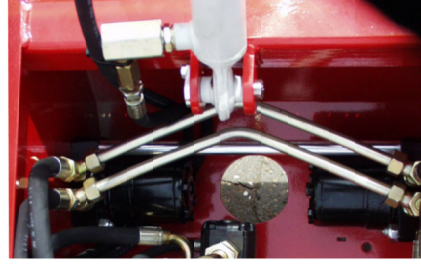

Page 6

TABLE OF CONTENTS

Survey	Page 1
External parts	Page 2
Valves, cables etc.	Page 3
Petrol tube, safety fittings etc.	Page 4
Engine, clutch, hydrostaticpump, gearpump	Page 5
Wheelengine, hydraulic cylinder etc.	Page 6
Extra equipment	Page 7
Electric parts	Page 8
Hydraulic tubes before series no. 050503-00	Page 9
Hydraulic tubes after series no. 050503-00	Side 10
Bypass valve for drive / free run	Side 11
Safety bumper	Side 12

26



27

SUPER SKUB
hydra



12

13



14



15



11

41



2



45



3

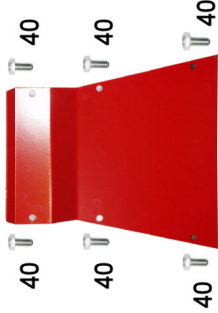

16



40



40



40



25

FREMDRIET FRILOB STOP
CHOKEN DANS FRIEVE DANK TIPS

28



32



31



30



44



29

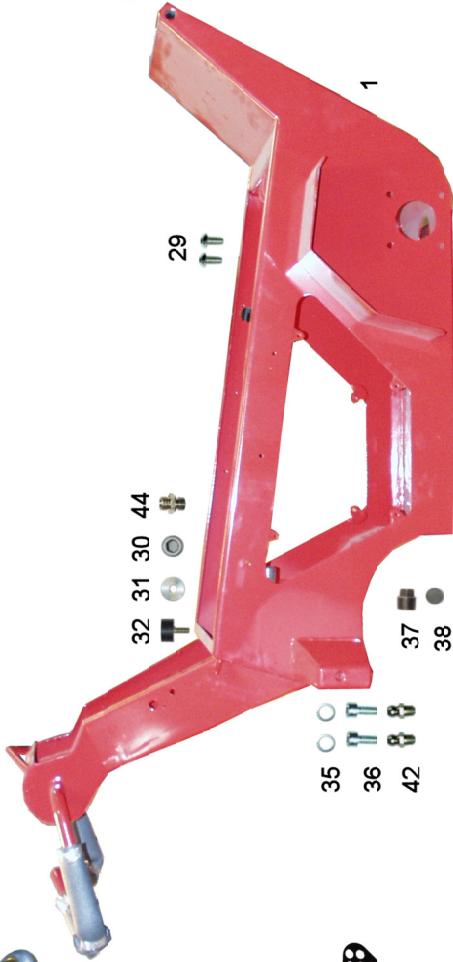

1

35



36



42



37



38



4



33



34



7



6



8



9

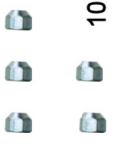

10



5



33



34



23



22



21



19



20



24

HG
HEDENSTED
GRUPPEN

Pos. No.	HG No.	Description	Note	PCS.
1	423402	Frame for SS hydra		1
2	423400	Container for SS hydra		1
3	423411	Coverplate for frame		1
4	423434	Ventilation plate Left		1
5	423456	Ventilation plate Right		1
6	423466	Fork wheel S. S.Hydra		2
7	423465	Fork for wheel DGT 12"		2
8	474733	Wheel F. LP190-8/8 Hf400 silve		2
9	423471	Wheel hub for omrw		2
10	479910	Wheel nut M12x1,5 NV22 60' FZE		10
11	43354	Handle with plate		1
12	423416	Butterfly handle		1
13	76006012	Bolt buttonhead 6x12 FZB		1
14	89505022	Slotted pin 5x22mm black		2
15	87606000	Washer ø6,5x16,5x3 FZB		1
16	423431	Edge protection strip		0,9
17	423410	Tilting shaft for hydra		1
18	423428	Slide Bearing PAF-20165		2
19	441052	Handle recoil gx 140		1
20	423470	Starter string 4,5 mm		1,7
21	445091	Cap gasolin GX200		1
22	441725	Turn off switch GX 200		1
23	423460	Oil level indicator		1
24	414028	Ball valve bended handle		1
25	423438	Logo forward, rev, tilt, throttle,		1
26	423478	Edge profil w/Lip 54 mm		0,3
27	423440	Logo SS Hydra		1
28	423477	Warning logo DK		1
29	76005010	Bolt buttonhead 5x10 FZB		2
30	50606500	Plug male 1/4"		1
31	423484	Spacer for rubber		2
32	423422	Vibration absorber 30x15xM8x		2
33	11408016	Hexagon bolt M8x16 FZB		9
34	82108000	Washer M8 FZB		8

Pos. No.	HG No.	Description	Note	PCS.
35	84506000	Spring washer M6 FZB DIN-7980		2
36	10206012	Bolt Unbrako cyl 6x12 FZB		2
37	413038	Plug black 1/2", GF		1
38	423475	Magnet Permax 302ø12,5x5mm		1
39	423421	Vibration damper Ø65		1
40	11408020	Hexagon bolt M8x20 FZB		10
41	423423	Slide bearing ø12/ø14-7mm		1
42	423068	Lubricating nipple M6 straight		2
9	423476	Wheel hub f. White motor		2
43	423542	Spacer for rubber		1
44	477126	Male stud 22L 3/4" DM		1
45	31009	Warning sign. Crushing		1

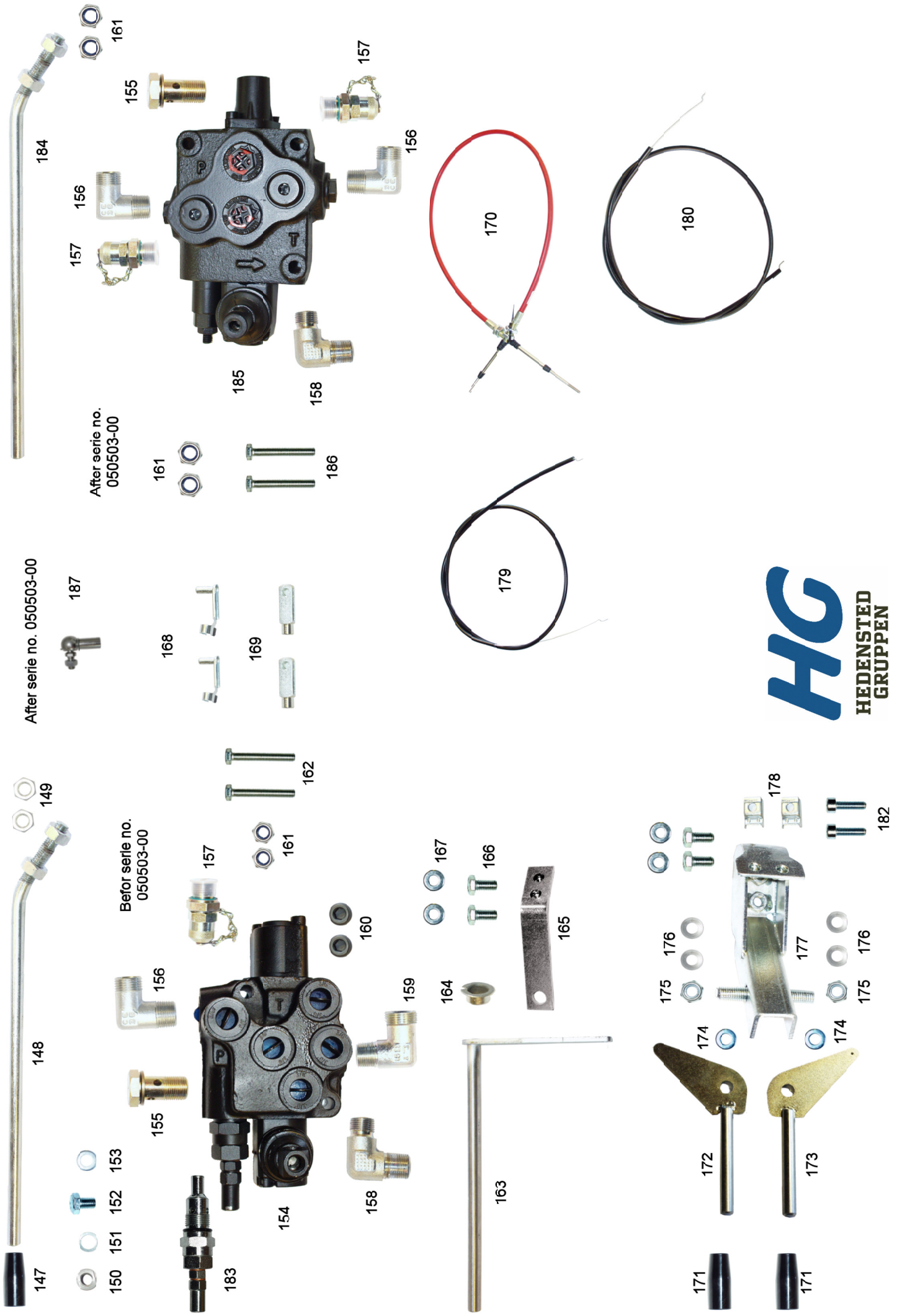

After serie no. 050503-00

After serie no. 050503-00

Before serie no. 050503-00

Pos. No.	HG No.	Description	Note	PCS.
147	423424	Cyl. Handle		1
148	423417	Arm f. tip valve		1
149	1510000	Nut M10 FZB		2
150	423482	Nut for stop screw		1
151	87512000	Spring washer M12 FZB		3
152	11412016	Hexagon bolt M12x16 FZB		1
153	82112000	Washer M12 FZB		1
154	423457	Control valve		1
155	477222	Connector 3/8" Banjo		1
156	477139	Elbow stud Ø12-L 3/8"K-DM		2
157	477229	Male test nipple 3/8" BSP		1
158	477105	Elbow stud 3/8"-3/8" PT		1
159	477146	Elbow 15L 3/8"		1
160	477295	Plug 3/8 BSP		2
161	17908000	Self-locking nut M8 FZB		10
162	11408055	Hexagon bolt M8x55 FZB		2
163	423408	Shaft for handle		1
164	423423	Slide bearing ø12/ø14-7mm		1
165	423414	Bracket for butterfly handle		1
166	11408016	Hexagon bolt M8x16 FZB		4
167	82108000	Washer M8 FZB		4
168	423443	Snap ring for fork G5x20		2
169	423432	Fork for cable G5x20		2
170	423430	Morse - cable		1
171	423424	Cyl. handle		2
172	423426	Gas choke handle left		1
173	423413	Gas choke handle right		1
174	82110000	Washer M10 FZB		6
175	27210000	Self-locking nut M10 FZB		3
176	89310080	Disc spring 20x10,3x0,8 black		4
177	423412	Brace for throttle and choke		1
178	423419	Cable clamp		4
179	423429	Gas cable S.S. Hydra.		1

Pos. No.	HG No.	Description	Note	PCS.
180	423437	Choker cable S.S. Hydra.		1
182	10205012	Bolt Unbrako cyl 5x12 FZB		4
183	423517	Release valve 100-190 bar		1
		After series no. 050503-00		
184	423522	Handle for tilt valve		1
185	423520	Hydraulic tilt valve		1
186	11408060	Self-locking nut M8 FZB		1
161	17908000	Self-locking nut M8 FZB		2
187	489103	Ball joint AS08-M05 Formatic		1

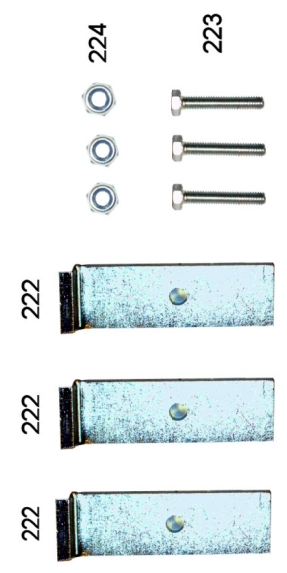
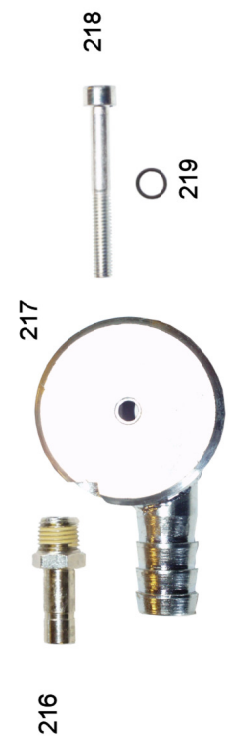
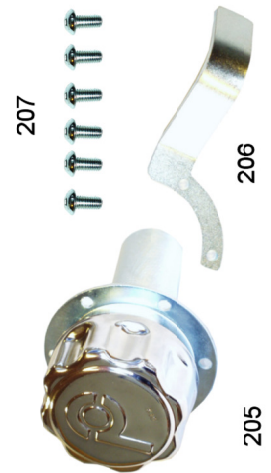
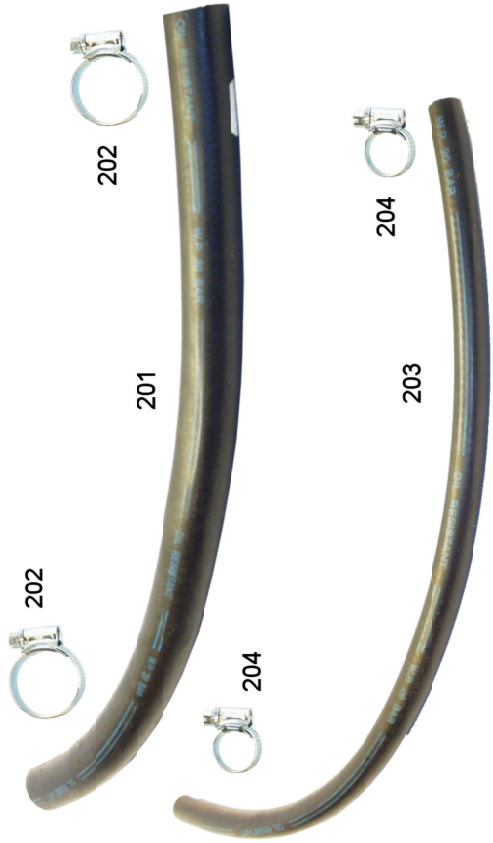

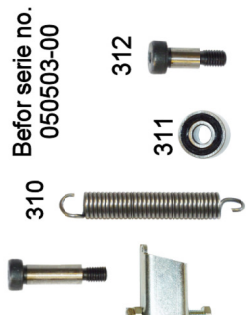
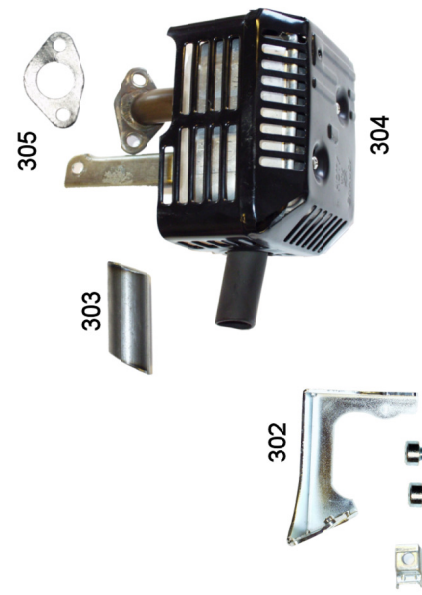
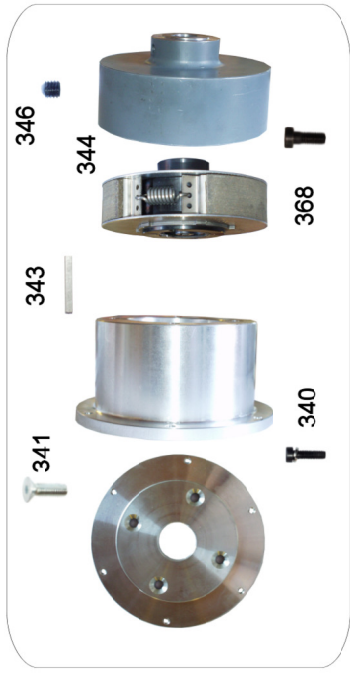

Before serie no.
050503-00

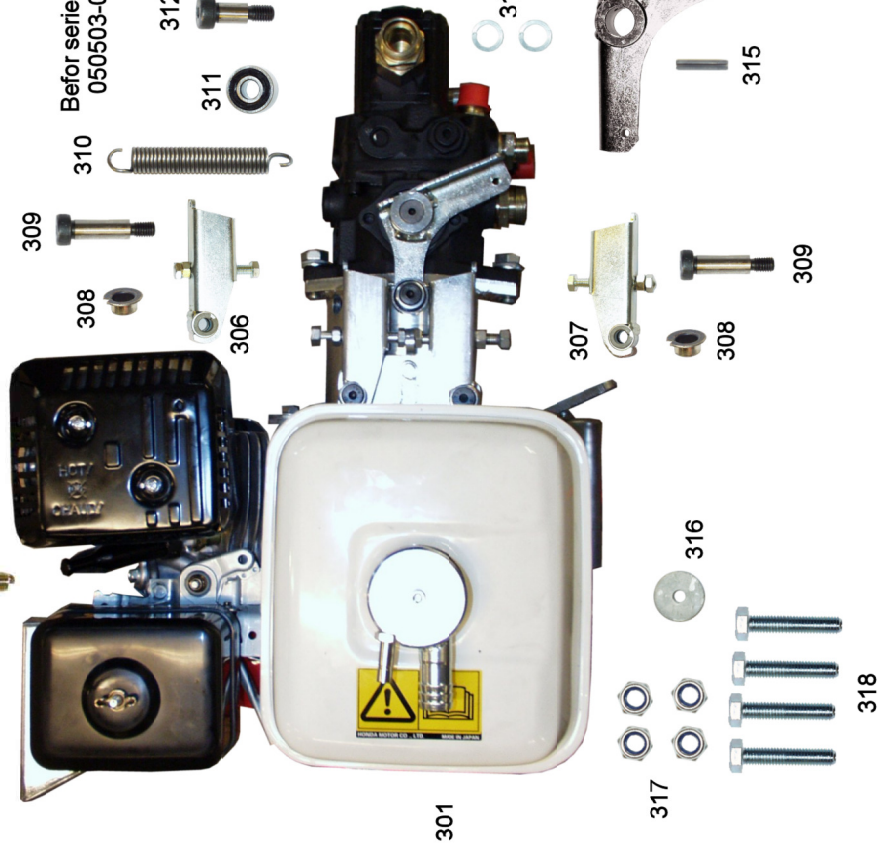

HG
HEDENSTED
GRUPPEN

Pos. No.	HG No.	Description	Note.	PCS.
301	441700	Honda GX200 recoil start		1
302	441705	Honda GX200UT elec. start		1
303	423415	Throttle-Choke brace		1
304	423420	Pipe for exhaust		1
305	441088	Exhaust for SS Hydra		1
306	441095	Exhaust gasket GX 140		1
307	423405	Arm f. return position, R		1
308	423406	Arm f. return position, L		1
309	423445	Slide bearing ø10/ø12-7mm		4
310	423447	Setting plug M8 ø10x30mm		2
311	423453	Pull spring		1
312	473004	Ball bearing 63000-2RS16		1
313	423448	Setting plug M8 ø10x16mm		1
314	87512000	Spring washer M12 FZB		2
315	423404	Arm f. hydrostat		1
316	89506030	Slotted pin 6x30mm black		1
317	83608040	Washer Ø42x9x4 FZB		4
318	17908000	Self-locking nut M8 FZB		10
319	11408040	Hexagon bolt M8x40 FZB		4
320	82112000	Washer M12 FZB		11
321	423435	Cluch housing		1
322	20406012	Hexagon countersunk 6x12 FZB		3
323	423441	Washer for clutch/pump		1
324	423433	Bush for centrifugal clutch		1
325	423436	Screw for centrifugal clutch		1
326	10505010	Pinbolt 5x10		1
327	423403	Clutch		1
328	423498	Brake coating kit		1
329	11412030	Hexagon bolt M12x30 FZB		2
330	423454	Hydrostatic pumpe		1
331	477164	Washer with seal, Nitril		1
332	423455	Gear pump		1
333	423493	Key for PV14		1
334	423491	O-ring for gear pump		1

Pos. No.	HG No.	Description	Note	PCS.
334	10208080	Bolt Unbrako cyl.8x80 FZB		2
335	476052	Spark plug NGK BPR6ES		1
339	423518	Drive key for gear pump		1
360	477116	Male stud 22L 1/2"		1
361	477233	Reduction 3/4" - 3/8"		1
362	477118	Male stud 12L 3/8"		1
363	477117	Male stud Ø15-L 3/8" DM		1
364	477120	Male stud Ø15-L 1/2" DM		2
365	477116	Male stud 22L 1/2"		1
367	423503	Brake kit F/suco clutch		4
368	50705020	Bolt Unbrako cyl.8x20		1
		Efter serie nr. 050503-00		
340	10206020	Bolt unbrako cyl 6x20 FZB		6
341	20408025	Hexagon countersunk 8x25 FZB		4
342	423487	Centrifugal clutch w. housing		1
343	423548	Key for Axial pump		1
344	423507	Centrifugal clutch		1
345	423508	Brake coat set S.S. - Hydra		1
346	10505010	Pin bolt 5x10		1
347	423530	Hydrostate pump V014		1
348	423528	Brace for sterring cable		1
349	489103	Ball joint AS08-M05 Formatic		1
350	423533	Drive key		1
351	423534	Gear pump incl. clutch		1
352	10208080	Bolt unbrako cyl. 8x80 FZB		2
353	423532	Hydrostatic pump Axial		1
354	477097	Male stud 3/8" x 3/4" PP		1
355	477120	Male stud Ø15-L 1/2" DM		1
356	477110	Male stud 12L 1/4"		1
357	477141	Adjustible elbow ø15L 1/2 K-DM		1
358	477208	Steam reducer 15L 22L		1
359	477146	Elbow 15L 3/8"		1
366	423531	Axial spring D=4,0 f/ Vo pump		1
367	477117	Male stud Ø15-L 3/8" DM		1



419



416



415



412



413



406



414



402



401

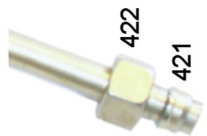

421

422



403



404



405



418



411



408



407



420



409



410



417





501

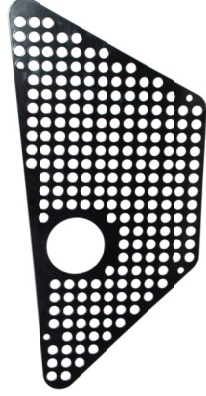

503

507



502

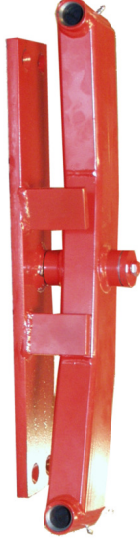

504



506



506



505

336



337



338

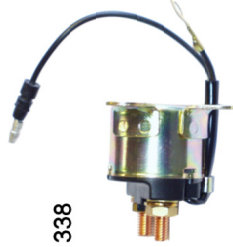

613



614



611

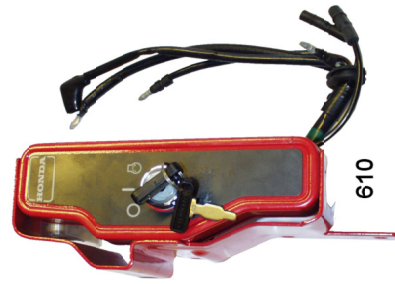

610



605



604



603



602



601



607



606



606

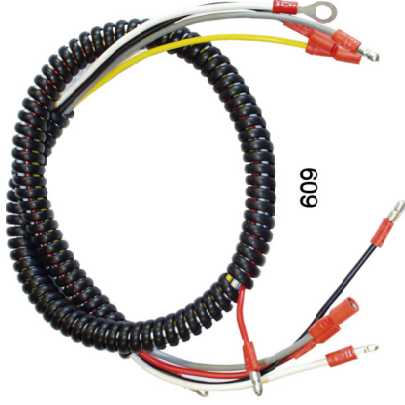

609



612



608

HG
HEDENSTED
GRUPPEN

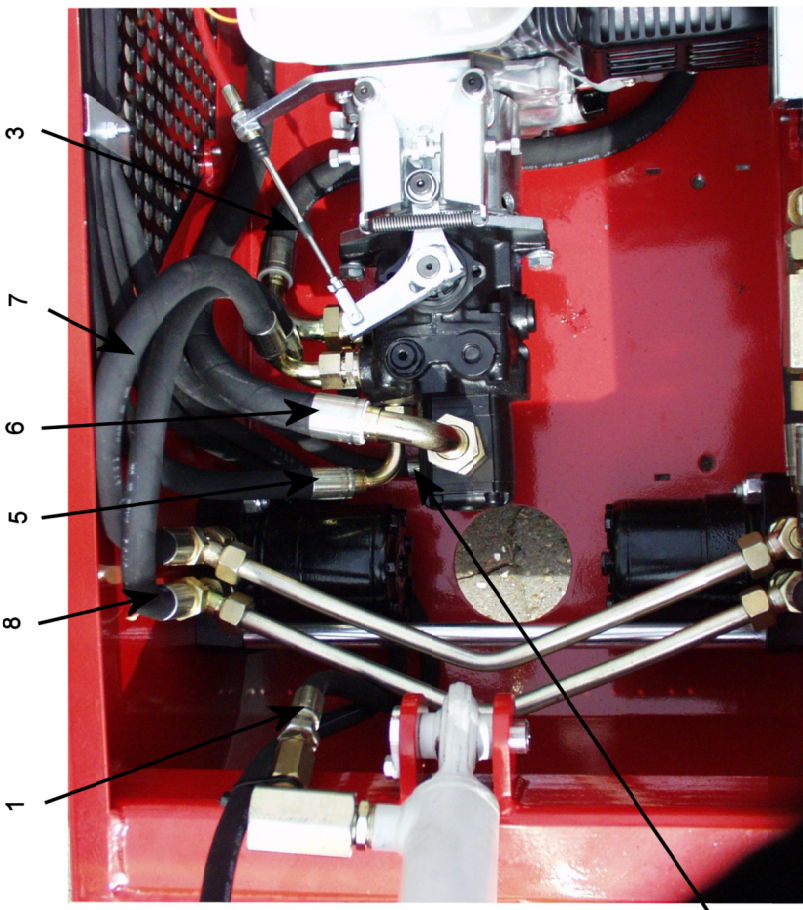
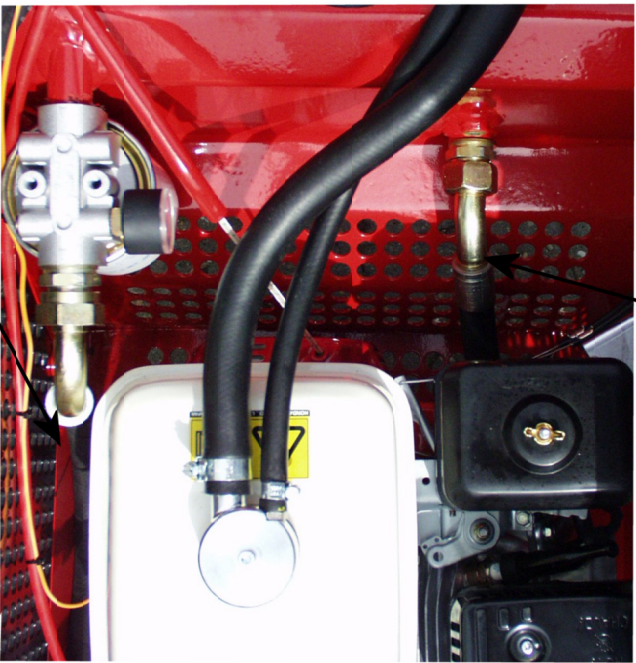
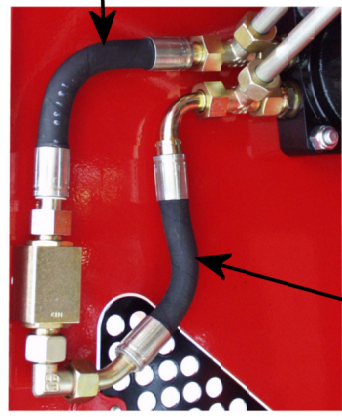
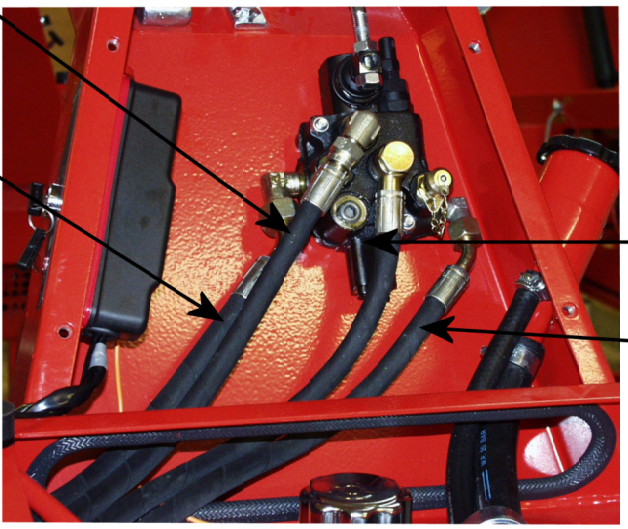

After serie no.
050503-00

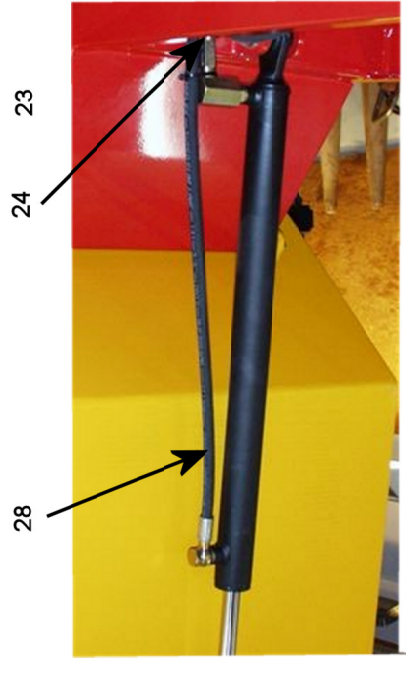
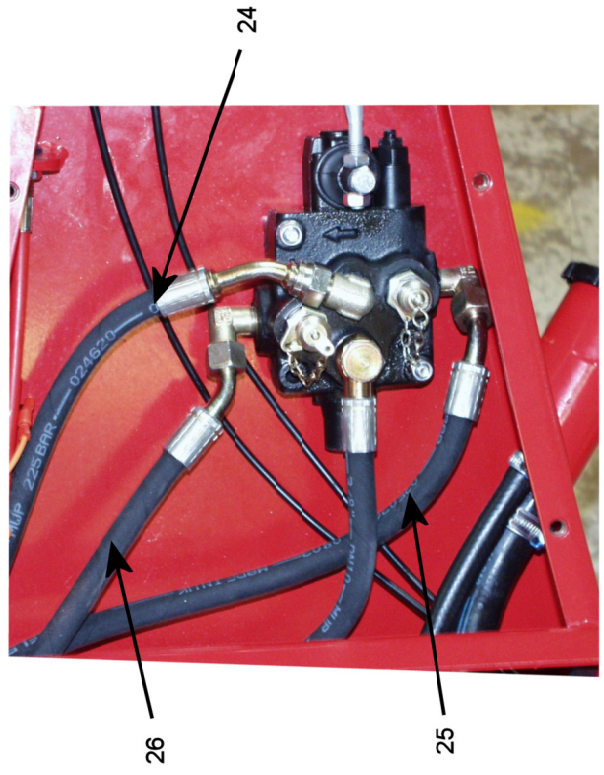
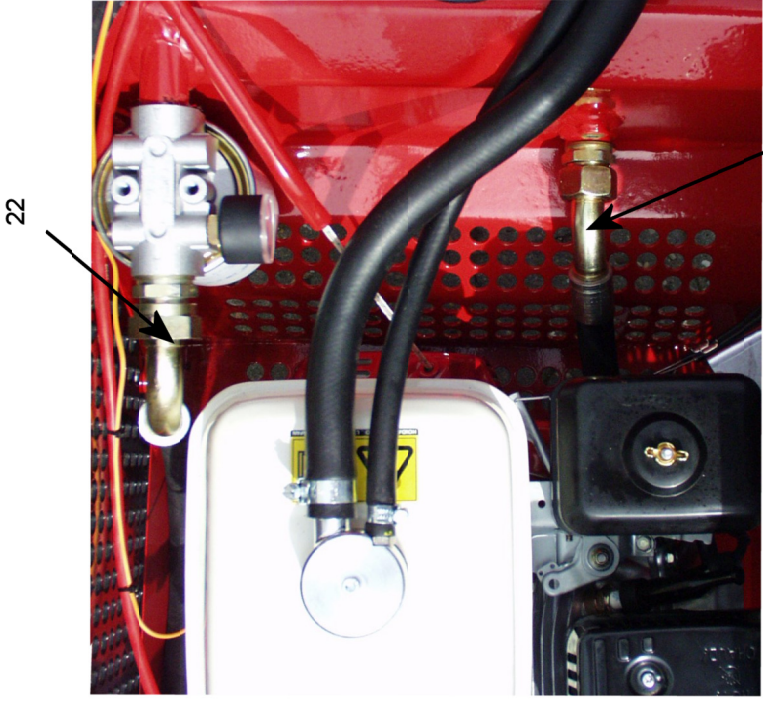
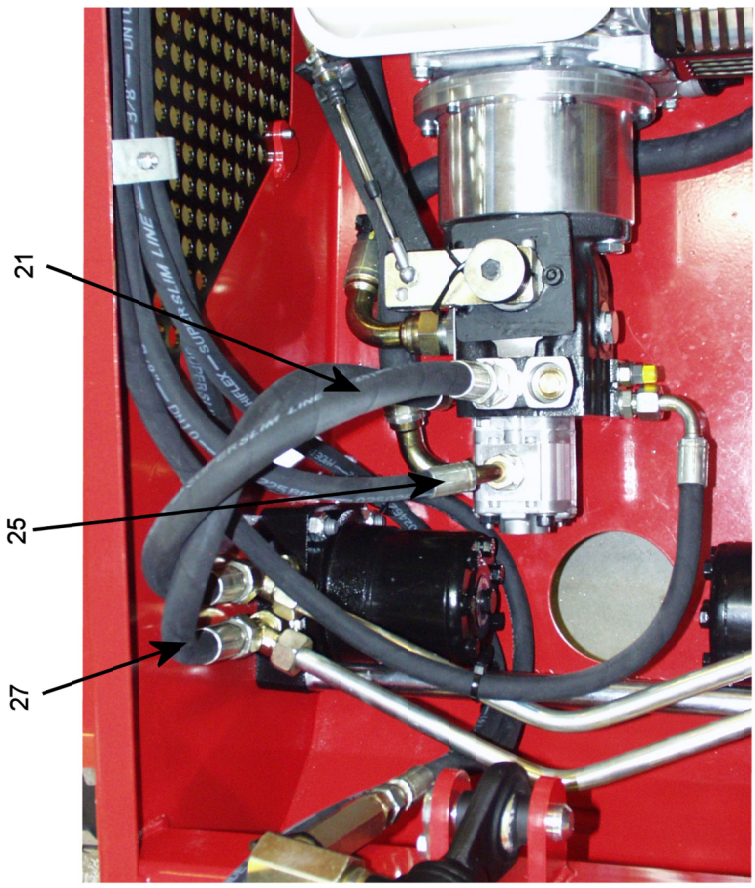

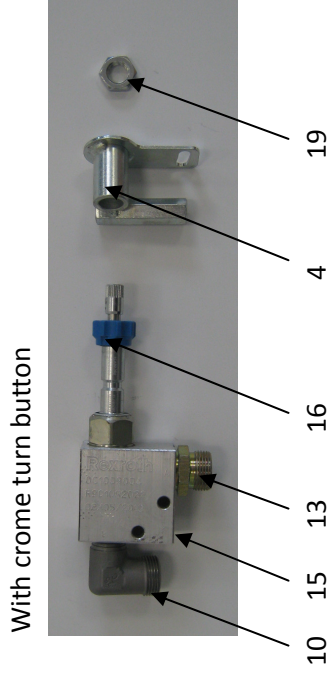
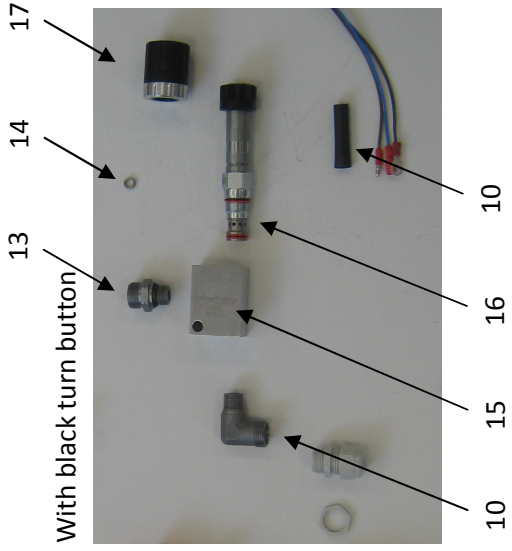
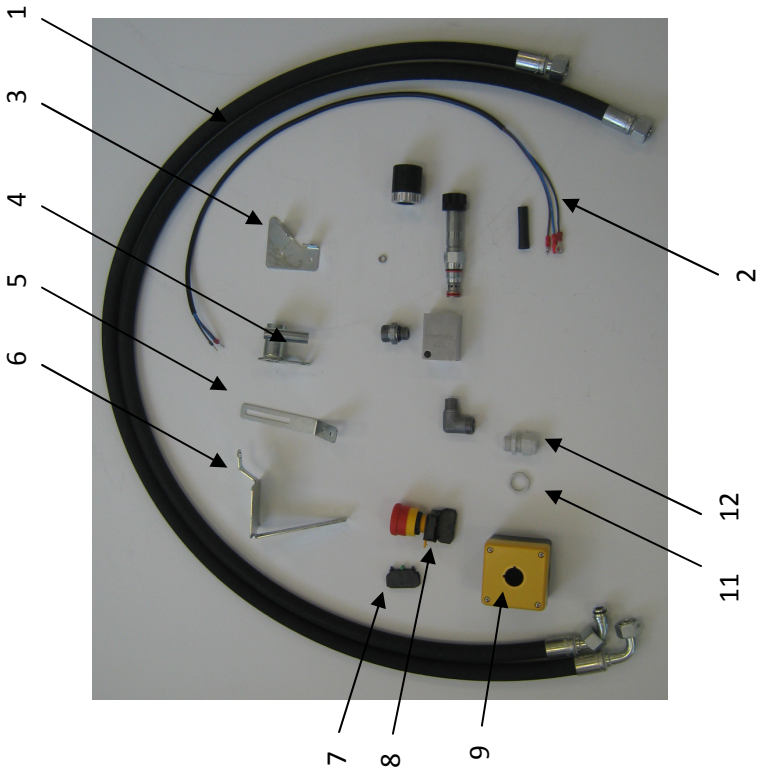

701

702



705

706



707



708

710

709



703



711



712



704



713

714

714

715

716

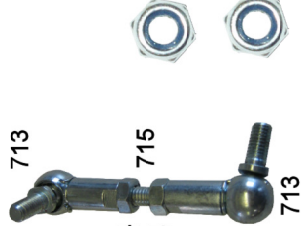

717



