

Please register your product at
www.vovousa.com
 to receive full **warranty benefits**.

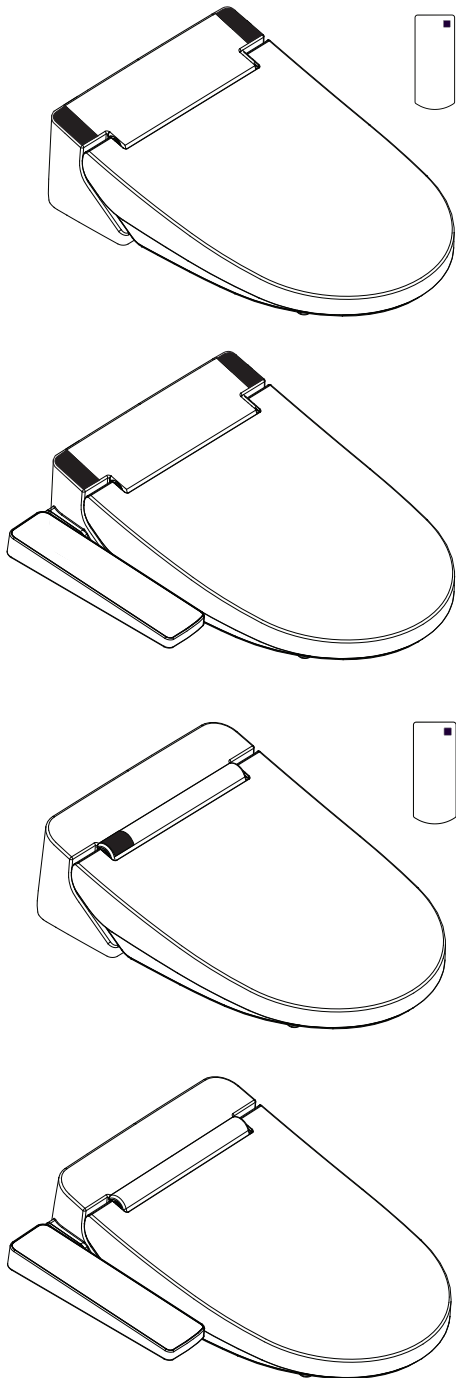

VOVO STYLEMENT BIDET USER MANUAL

- **VB-6000SE (elongated)**
 VB-6100SR (round)
- **VB-5000SE (elongated)**
 VB-5100SR (round)
- **VB-4000S (elongated)**
 VB-4100S (round)
- **VB-3000S (elongated)**
 VB-3100S (round)

TABLE OF CONTENTS

Product Characteristic	2
Safety Precautions	5
Name of Parts	10
Installation Method	14
How to Use	16
Maintenance	24
Troubleshooting	25
Specifications	28
Limited Warranty	29
VOVO Warranty	30

- ※ Thank you for choosing our bidet.
- ※ This manual includes the warranty. Keep the manual to receive customer service.
- ※ Read this manual carefully before use.

To Our Customers

- Thank you for choosing our bidet.
- For your own safety, please read this manual carefully.
- Please refer to this manual if you have any questions while using the product.
- We are not responsible for damages caused by misuse.
- Product warranty is included in this manual. Please do not lose it.

Product Characteristic

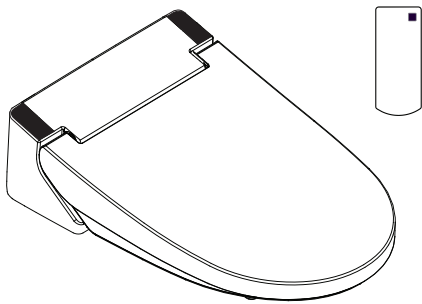

VB-6000SE (elongated)
VB-6100SR (round)

Posterior wash / Feminine wash /
Turbo wash / Dry / LED light

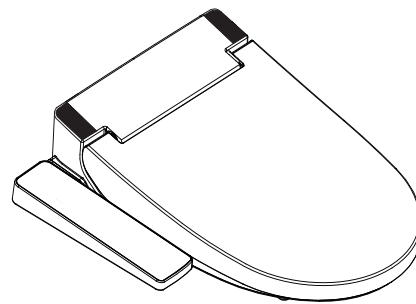

VB-5000SE (elongated)
VB-5100SR (round)

Posterior wash / Feminine wash /
Turbo wash / Kids / LED light

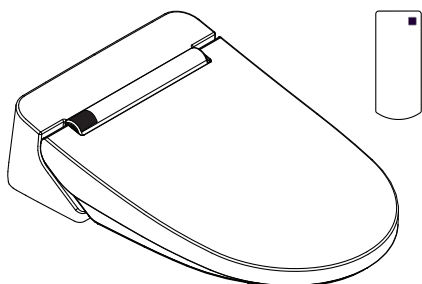

VB-4000S (elongated)
VB-4100S (round)

Posterior wash / Feminine wash /
Turbo wash / Dry / LED light

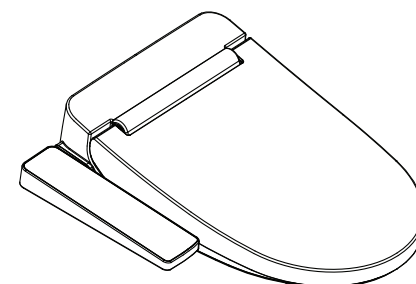

VB-3000S (elongated)
VB-3100S (round)

Posterior wash / Feminine wash /
Turbo wash / Kids / LED light



IMPORTANT SAFETY INSTRUCTIONS

When using electric appliances, especially when children are present, basic safety precautions should always be followed, including the following.

READ ALL INSTRUCTIONS BEFORE USING

DANGER - As with most electric appliances, electrical parts are electrically live even when switch is off. To reduce the risk of death by electric shock:

1. Do not use while bathing.
2. Do not place or store appliance when it can fall or be pulled into a tub or sink.
3. Do not place in or drop into water or other liquid.
4. If an appliance falls into water, unplug it immediately. Do not reach into the water.

WARNING - To reduce the risk of burns, electrocution, fire or injury to persons

1. Close supervision is necessary when this appliance is used by, on, or near children or invalids.
2. Use this appliance only for its intended use as described in this manual. Do not use attachments not recommended by the manufacturer.
3. Never operate this appliance if it has a damaged cord or plug, is not working properly, or has been dropped, damaged, or dropped into water. Return the appliance to a service center for examination and repair.
4. Keep the cord away from heated surfaces. Do not wrap the cord around the appliance.
5. Never block the air openings of the appliance or place it on a soft surface, such as a bed or couch, where the air openings may be blocked. Keep the air openings free of lint, hair, and other objects.
6. Never use while sleeping
7. Never drop or insert any object into any opening or hose.
8. Do not use outdoors or operate where aerosol (Spray) products are being used or where oxygen is being administered.
9. Do not use an extension cord with this appliance.
10. Use this appliance only for household use
11. Connect this product to a properly grounded outlet only. See grounding Instructions.



CONSIGNES DE SÉCURITÉ IMPORTANTES

Lors de l'utilisation d'appareils électriques, en particulier lorsque des enfants sont présents, des précautions de sécurité de base doivent toujours être suivies, y compris les suivantes

LISEZ TOUTES LES INSTRUCTIONS AVANT L'UTILISATION

DANGER - comme pour la plupart des appareils électriques, les pièces électriques sont électriquement actives même lorsque l'interrupteur est éteint.

Pour réduire le risque de décès par électrocution:

1. Ne pas utiliser pendant le bain.
2. Ne pas placer ni ranger l'appareil électrique dans un endroit où il peut tomber ou être tiré dans une baignoire ou un évier.
3. Ne pas placer ou le déposer dans l'eau ou autre liquide.
4. Si un appareil tombe dans l'eau, débranchez-le immédiatement. Éviter de toucher l'eau.

ATTENTION - Pour réduire le risque de brûlures, d'électrocution, d'incendie ou de blessure pour les personnes.







1. Une surveillance étroite est nécessaire lorsque cet appareil est utilisé par, sur ou près des enfants ou de personnes invalides.
2. Utilisez l'appareil uniquement pour l'utilisation prévue, comme décrit dans ce manuel.
N'utilisez pas des pièces jointes non recommandée par le fabricant.
3. N'utilisez jamais cet appareil s'il a un cordon ou une fiche endommagée, s'il ne fonctionne pas correctement, ou il a tombé, endommagé ou tombé dans l'eau. Renvoyer l'appareil à un centre de service pour examen et réparation.
4. Gardez le cordon loin des surfaces chaudes. Ne pas enrouler le cordon autour de l'appareil.
5. Ne jamais bloquer les ouvertures d'air de l'appareil ou le placer sur une surface douce, comme un lit ou un divan, où les ouvertures d'air peuvent être bloquées. Gardez les ouvertures d'air exemptes de peluches, de cheveux et autres.
6. Ne jamais l'utiliser en dormant.
7. Ne le faites pas tomber ou insérez un objet dans une ouverture ou un tuyau.
8. Ne pas l'utiliser à l'extérieur ou l'opérer dans un endroit où des produits en aérosol sont pulvérisés ou de l'oxygène est administré.
9. N'utilisez pas de rallonge avec cet appareil.
10. Utiliser cet appareil uniquement pour l'usage domestique.
11. Connectez ce produit à une prise de courant correctement mise à la terre uniquement.
Voir les instructions de mise à la terre.

CONSERVER CES INSTRUCTIONS

Safety Precautions

- Follow all safety precautions in this manual for your safety.
- Caution: In order to avoid hazard due to inadvertent resetting of the thermal cutout, this appliance must not be supplied through an external switching device, such as a timer, or connected to a circuit that is regularly switched on and off by utility.

※ The following terms are used in this manual to indicate hazards of varying degree of severity.

 Danger	Indicates an imminently hazardous situation which, if not avoided, will result in death or serious injury.
 Caution	Indicates a dangerous situation where the user could suffer death or serious injury if this product is used incorrectly.
 Prohibited	 Indicates prohibited.
 Observe strictly	 Indicates to observe the following precautions before using this product.

Danger

- Do not open the product to repair or remodel.

 Do not disassemble



- Do not touch the power cord with wet hands.

 Wet hand prohibited



- Do not exceed the rated voltage of the outlet or the distributor.
- Connecting too many plugs will exceed the rated power and can cause fire by overheat.

 Prohibited

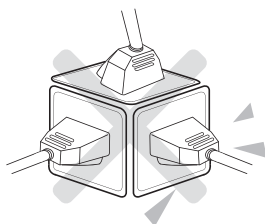

- Do not place fire such as cigarettes near the product.

 Fire prohibited



- Do not splash water or detergent on the main body or power plug.



- Unplug when to repair the product.

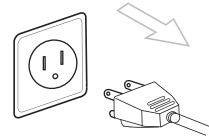

- Do not use damaged power cord, plug, or loose outlet, and do not supply power to the product which is not installed on toilet or not connected to water supply hose.

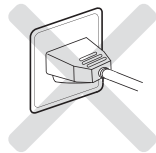

- When cleaning, use mild detergent and soft cloth.
- Do not use the following. <household detergent, benzene, paint thinner, nylon scrubber>



Use tap water.

Make sure the product is properly grounded.



- Do not connect with industrial water or gray water.

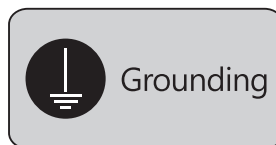

- If the product is not grounded, it can cause electric short or electric leakage.
- For grounding work, consult an electric technician nearby.

One of the following persons needs to have someone to turn off the temperature controller of the seat and warm air blower when using heated seat.



- Children or elderly persons who can not control the temperature appropriately by himself.
- Patients or sick persons who can not move her or his body by oneself.
- Persons on medication that make them drowsy, and fatigued and intoxicated persons.

 **Warning**

※ Do not use this product other than for purposes listed in this manual.

- Do not step on, shock, or place heavy objects on the seat, cover, or main body.



- Do not place hand or clothes on the warm air outlet.



- Unplug the main power cable when not using the product for a long time and drain water from the tank.

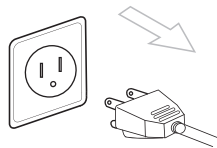

- Do not put anything else except toilet paper into the toilet.



Handle power cord carefully and do not break the cord

- Do not fabricate or assemble at user's own discretion.
- Do not bend, twist, or pull it forcibly.
- Do not place heavy objects on the cord.

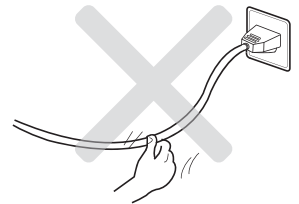

Do not continue to use the product with faults.

Unplug the power plug in the following case and call the distributor or customer service representative.

- Water leakage
- Strange odor
- Hot main body
- Smoke

GROUNDING INSTRUCTIONS

1. This product should be grounded. In the event of an electrical short circuit, grounding reduces the risk of electric shock by providing an escape wire for the electric current. This product is equipped with a cord having a grounding wire with a grounding plug. The plug must be plugged into an outlet that is properly installed and grounded.

DANGER - Improper use of the grounding plug can result in a risk of electric shock

If repair or replacement of the cord or plug is necessary, do not connect the grounding wire to either flat-head terminal. The wire with insulation having an outer surface that is green with or without yellow stripes is the grounding wire.

Check with a qualified electrician or serviceman if the grounding instructions are not completely understood, or if in doubt as to whether the product is properly grounded.

2. This product is for use on a nominal 120 V circuit, and has a grounding plug that looks like the plug illustrated in sketch A in Figure 1. A temporary adapter, which looks like the adapter illustrated in sketches B and C, may be used to connect this plug to a 2-pole receptacle as shown in sketch B if properly grounded outlet is not available. The temporary adapter should be used only until properly grounded outlet (sketch A) can be installed by a qualified electrician. The green colored rigid ear, lug, and the like extending from the adapter must be connected to a permanent ground such as a properly grounded outlet box cover. Whenever the adapter is used, it must be held in place by the screw.

3. If it is necessary to use an extension cord, use only a three wire extension cord that has a three-blade grounding plug, and a three-slot receptacle that will accept the plug on the product. Replace or repair a damaged cord.

4. This product is factory equipped with a specific electronic cord and plug to permit connection to a proper electronic circuit. Make sure that the product is connected to an outlet having the same configuration as the plug. No adapter should be used with this product. Do not modify the plug provided - if not will not fit the outlet, have the proper outlet installed by a qualified electrician, if the product must be reconnected for use on a different type of electronic circuit, reconnection should be made by qualified service personnel.

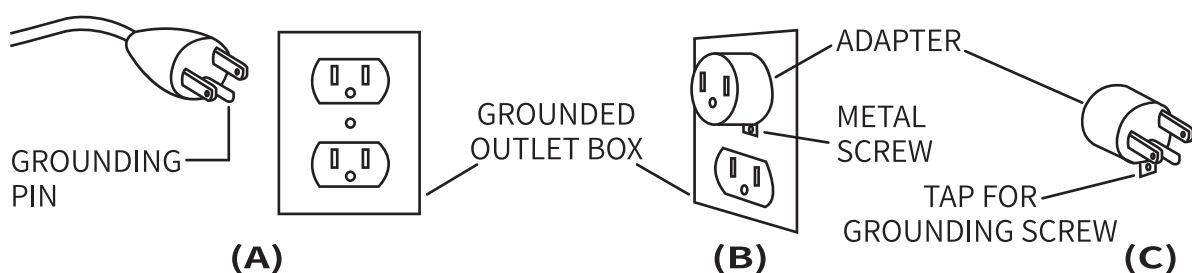

Figure 1.

Instructions de mise à la terre

1. Ce produit doit être mis à la terre. En cas de court-circuit électrique, la mise à la terre réduit le risque de choc électrique en fournissant un fil d'échappement pour le courant électrique. Ce produit est équipé d'un cordon ayant un fil de mise à la terre avec une fiche de mise à la terre. La fiche doit être branchée sur une prise correctement installée et mise à la terre.

DANGER - L'utilisation incorrecte de la fiche de mise à la terre peut entraîner un risque de choc électrique.

Si une réparation ou le remplacement du cordon ou de la fiche est nécessaire, ne connectez pas le fil de mise à la terre sur une borne à plat. Le fil avec l'isolant ayant une surface extérieure en vert avec ou sans rayons jaunes est le fil de mise à la terre.

Vérifiez auprès d'un électricien ou d'un technicien qualifié si les instructions de mise à la terre ne sont pas complètement comprises, ou si vous avez des doutes quant à savoir si le produit est correctement mis à la terre.

2. Ce produit est destiné à être utilisé sur un circuit nominal de 120 V et possède une fiche de mise à la terre qui ressemble à la fiche illustrée dans le croquis A de la Figure 1. Un adaptateur temporaire, qui ressemble à l'adaptateur illustré dans les croquis B et C, peut être utilisé pour connecter cette fiche à un réceptacle à 2 pôles comme indiqué dans le croquis B si une prise de courant correctement mise à la terre n'est pas disponible. L'adaptateur temporaire doit être utilisé uniquement jusqu'à ce qu'une prise de courant correctement mise à la terre (croquis A) puisse être installée par un électricien qualifié. L'oreille (La languette) rigide de couleur verte, le crochet, et les autres éléments similaires qui s'étendent de l'adaptateur doivent être connectés à un sol permanent tel qu'un couvercle de la boîte de sortie correctement mis à la terre. Chaque fois que l'adaptateur est utilisé, il doit être maintenu en place par une vis.
3. S'il est nécessaire d'utiliser une rallonge, utilisez uniquement un cordon de rallonge à trois fils doté d'une fiche de mise à la terre à trois lames et une prise à trois logements qui acceptera la fiche du produit. Remplacez ou réparez un cordon endommagé.
4. Ce produit est équipé en usine d'un cordon électronique spécifique et d'une prise pour permettre la connexion à un circuit électronique approprié. Assurez-vous que le produit est connecté à une prise de courant ayant la même configuration que la fiche. Aucun adaptateur ne doit être utilisé avec ce produit. Ne modifiez pas la fiche fournie - si elle ne correspond pas à la sortie, installez la prise appropriée par un électricien qualifié, si le produit doit être reconnecté pour une utilisation sur un autre type de circuit électronique, la reconnexion doit être faite par un personnel qualifié.

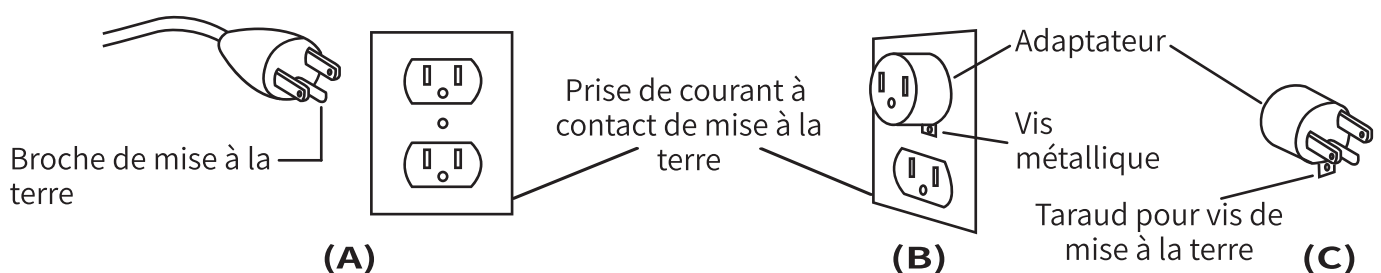
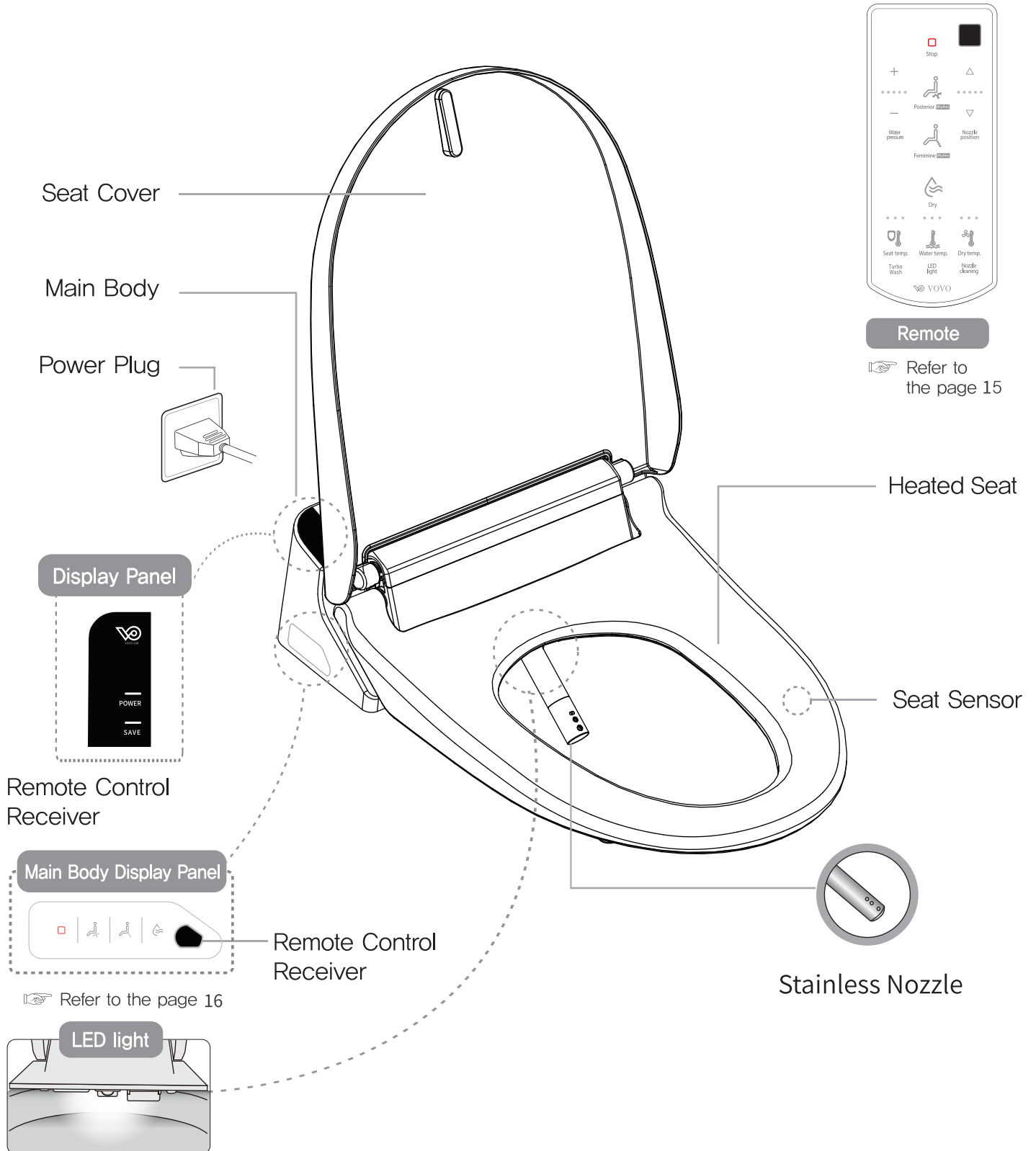

Figure 1.

Name of Parts

VB-6000SE (elongated)
VB-6100SR (round)



VB-5000SE (elongated)
VB-5100SR (round)

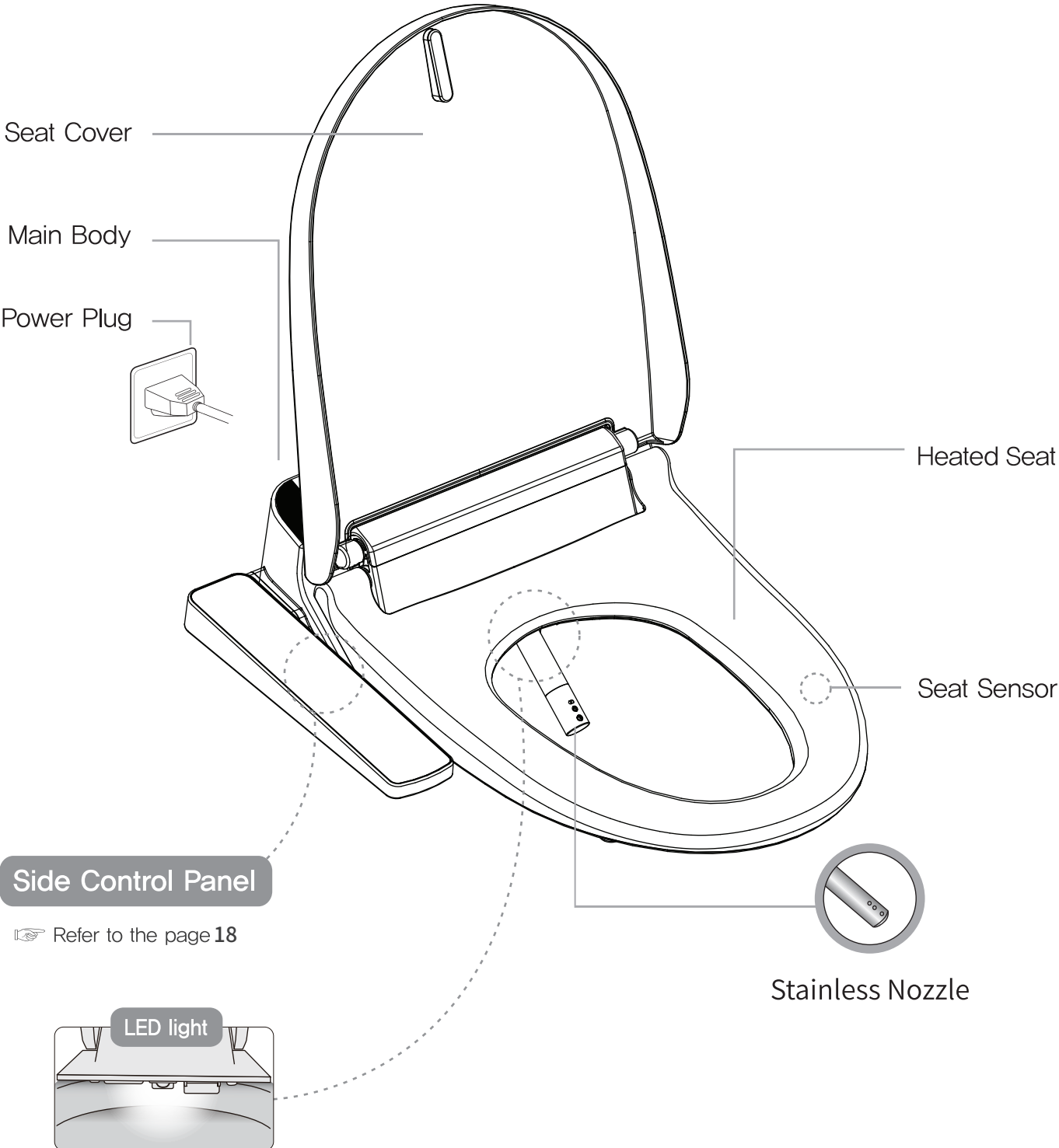

VB-4000S (elongated)
VB-4100S (round)

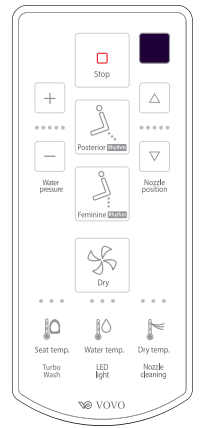

Remote

Refer to the page 14

Seat Cover

Main Body

Power Plug

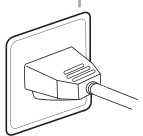

Display Panel

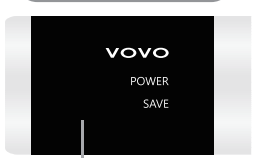

Remote Control Receiver

Main Body Display Panel



Remote Control Receiver

Refer to the page 20

LED light

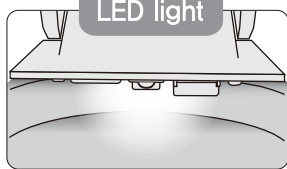

Heated Seat

Seat Sensor

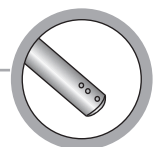

Stainless Nozzle

VB-3000S (elongated)
VB-3100S (round)

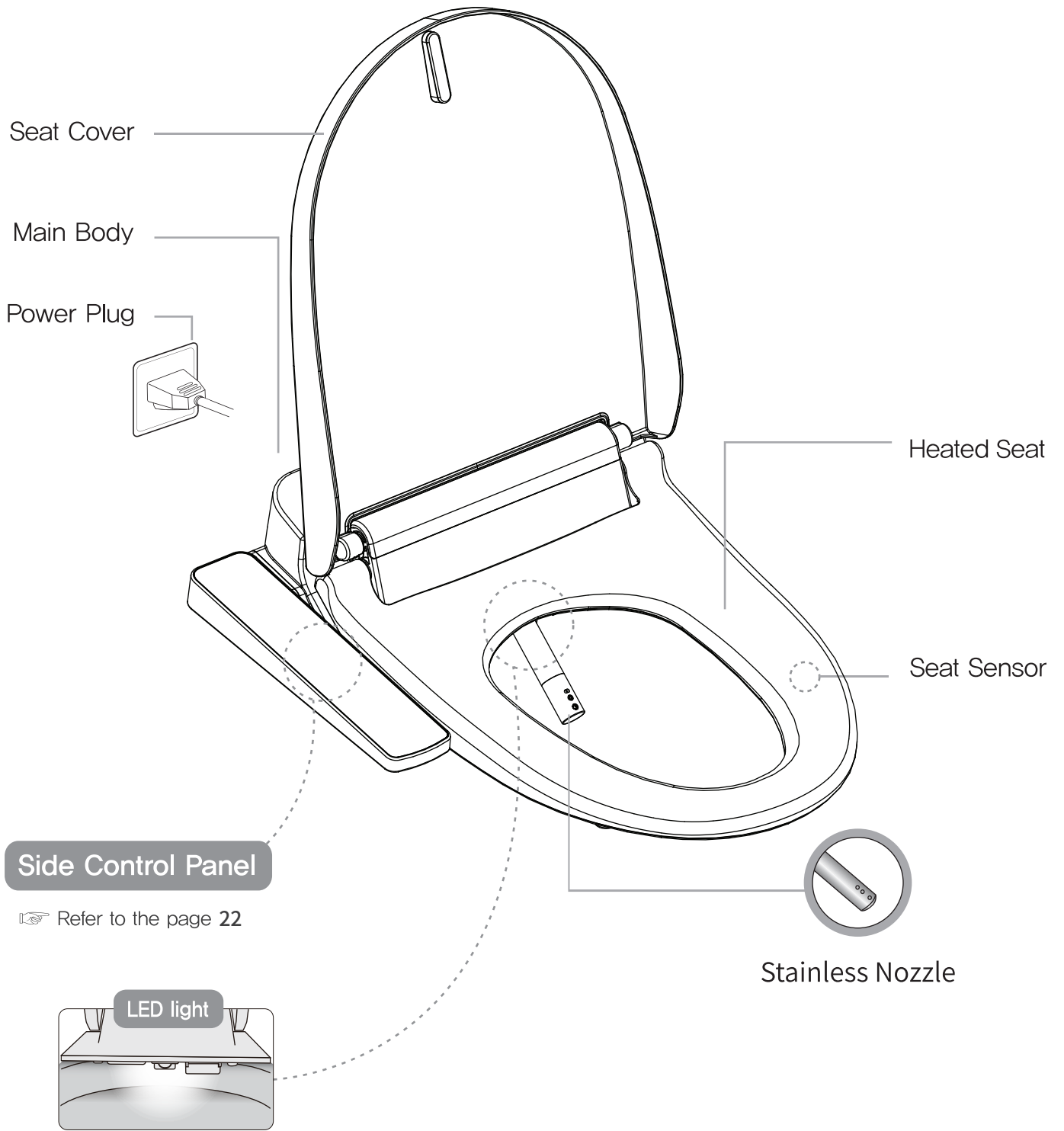

Installation Method

Accessories

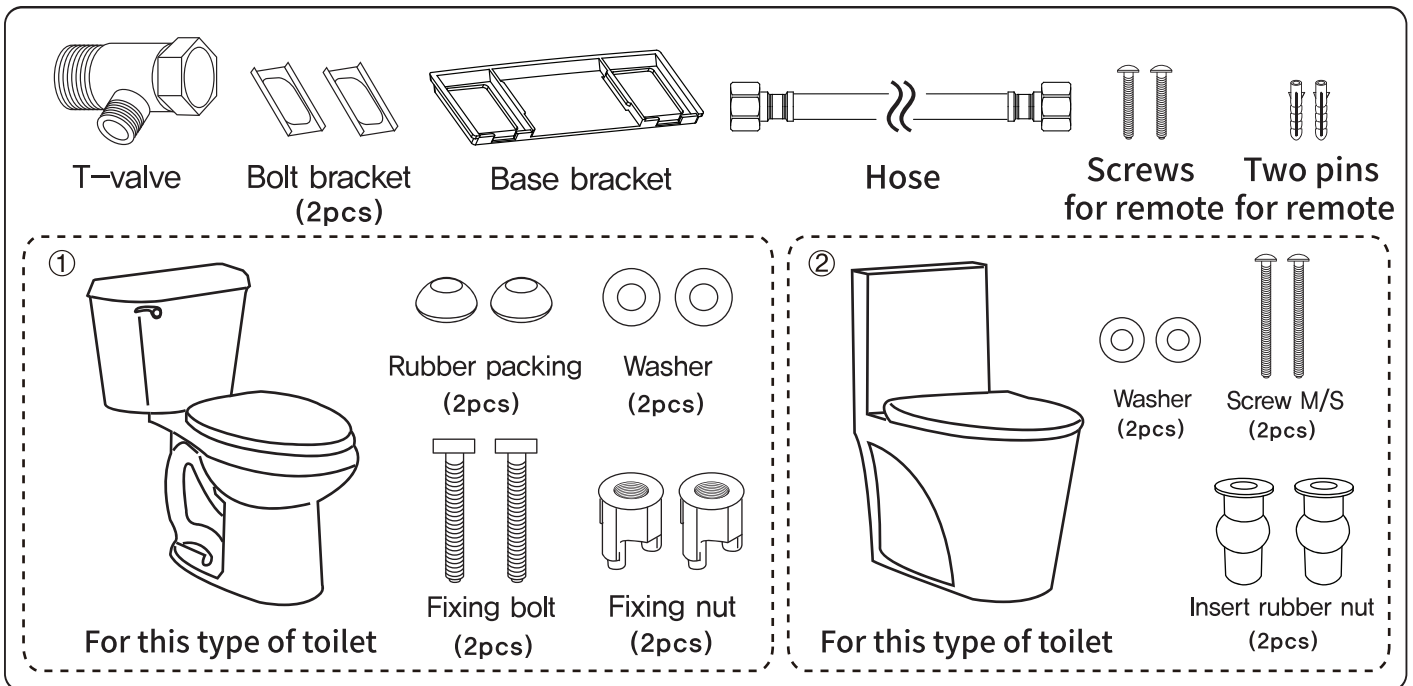

Before Installation

- Read the instructions carefully before installing.
- Plug in only after complete installation then supply water.

Installation Procedure

1 Separate water supply hose

- Turn the water supply valve clockwise to lock, and separate the toilet hose using a spanner

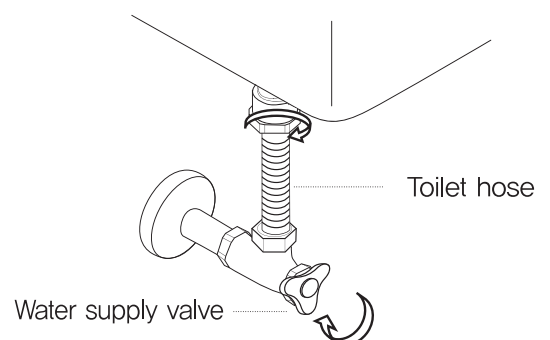

2 Connect the T-valve to the toilet and toilet hose

- Place the T-valve between the toilet and the toilet hose

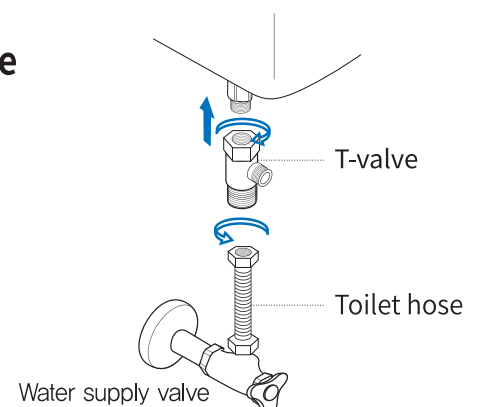

3 Remove the existing toilet seat

- Unfasten the nut and remove the toilet seat.
- Save the old toilet seat lid and nuts for reinstallation later.
- Place the template on the toilet after removing the toilet seat cover.

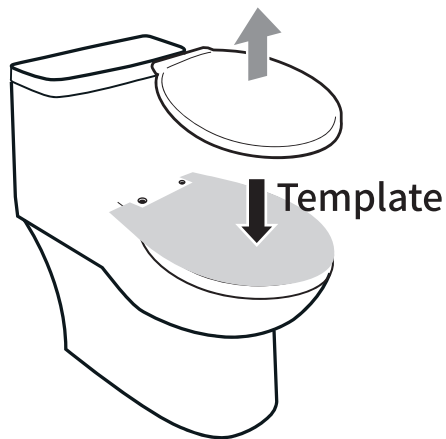

4 Install the base bracket

- Place the fixing bolt on the base bracket.
- Align the front of the bidet body and the front of the toilet before fastening the nuts.

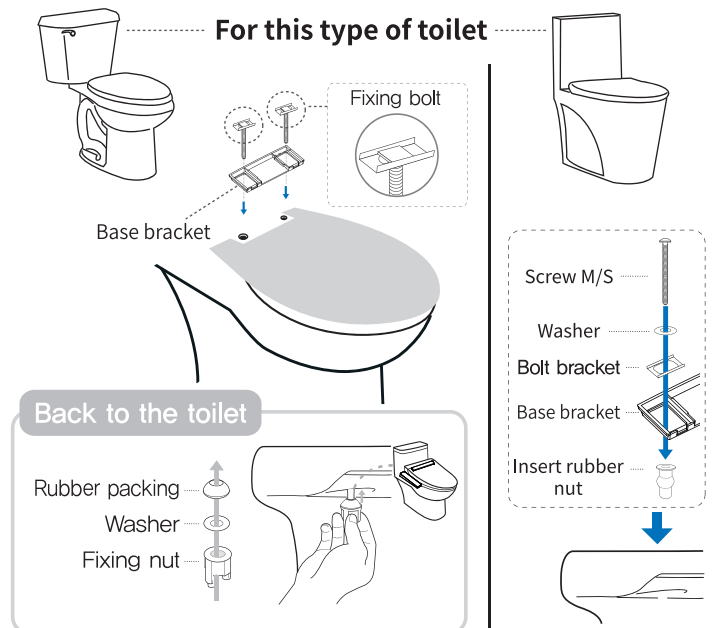

5 Install the bidet and secure the remote control holder

- Slide the bidet and install it.

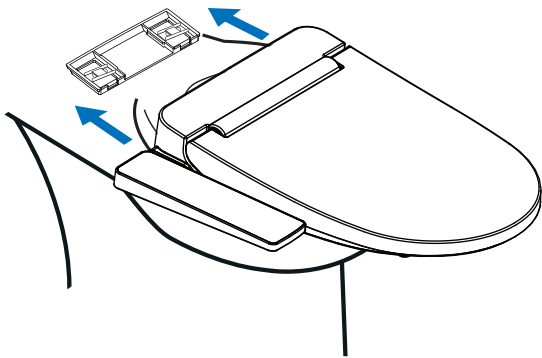

- Secure the remote control holder to the wall with screws or peel off the double-sided tape sticker on the back of the remote.

6 Connect the hose and turn on the water

- Connect the hose to the T-valve and the bidet.
- Turn the water supply valve counterclockwise to allow water flow.
- Connect the outlet.

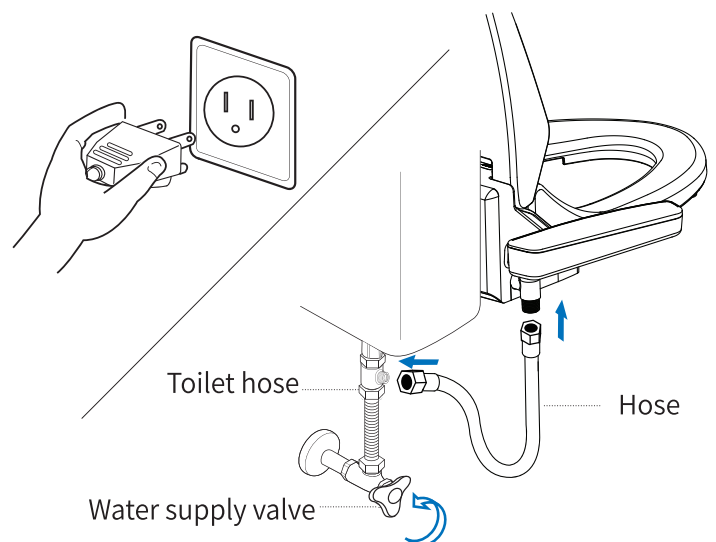

Operation Check

1. Turn the water supply valve counterclockwise to check for water leakage.
2. Connect the power plug into electrical outlet.
3. Pressing the Posterior button will make water flow into the water tank.
4. Check the functions of ter each use.

How to Use

Stop

Press the Stop button when you want to stop the function.

Dry

Use this after using wash function

- Wipe off the water with toilet paper before using dry function for pleasant using.

Water Pressure, Nozzle Position

- Can control in 5 levels of water pressure and nozzle position.

Water Pressure and Nozzle Position Adjustment

- Water pressure and nozzle position can be adjusted in 5 levels.



LED Light

The LED lamps illuminate the toilet bowl with a warm glow.

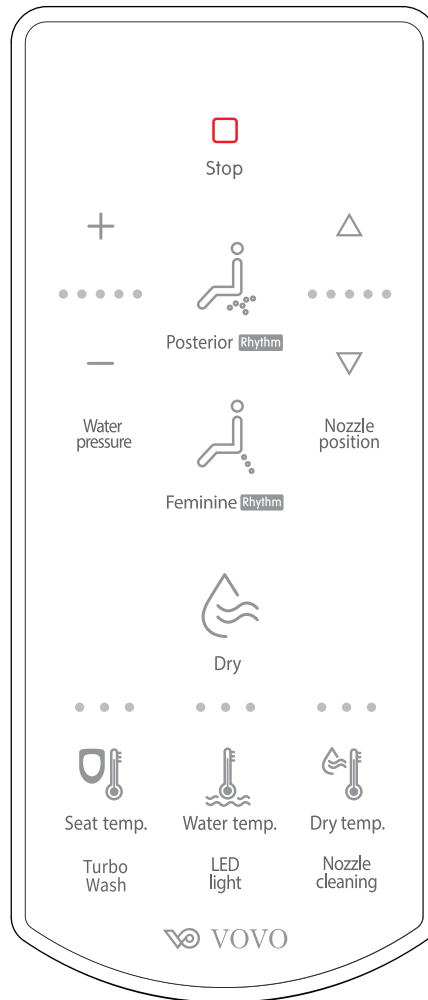

VB-6000SE (elongated) VB-6100SR (round)

Posterior/Rhythm

- Press Posterior/Rhythm button, to operate washing function.
- Press Posterior/Rhythm button again during using this function. Rhythm(Pulsating) function will work.

Feminine/Rhythm

- Press Feminine/Rhythm button, to operate Feminine function.
- Press Feminine/Rhythm button again when during using this function, Rhythm(Pulsating) function will work.

Turbo Wash

- Press Turbo button, Turbo wash will operate.
- It starts from the lowest water pressure.

Water Temperature, Seat Temperature Dry Temperature

- 3 levels of Water Temperature / Seat Temperature / Dry Temperature

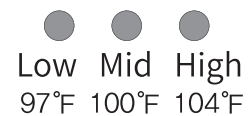

Nozzle Cleaning

- You can clean the nozzle by pressing the Nozzle cleaning button.

Side Panel

Power

Press the button for 3 seconds if you wish to turn off the bidet. Press the button if you wish to stop posterior, feminine or dry function.

Power Saving

Press the STOP button once on the side control panel of the product without seating to operate power save mode. Press the STOP button once more without seating to turn off the power save mode.

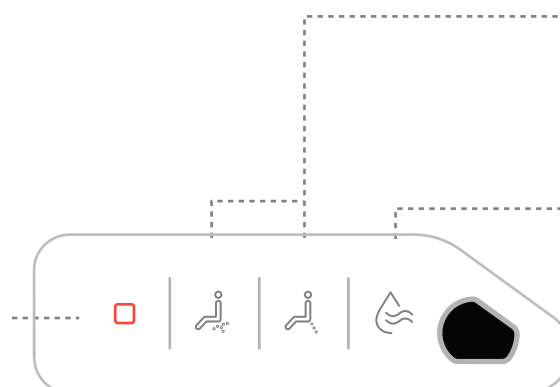

Posterior Wash / Feminine Wash

Press the button to operate the functions. The operations will stop if you press the button again.

Dry

- Press the button to operate the functions. The operations will stop if you press the button again.

Manuel de l'utilisateur

VB-6000SE (modèle allongé)
VB-6100SR (modèle rond)

Stop

Appuyez sur le bouton « Stop » pour stopper le fonctionnement en cours.

Séchage (Dry)

Utilisez le séchage après avoir utilisé la fonction de lavage

- Essuyez l'eau avec du papier toilette avant d'utiliser la fonction de séchage pour un usage agréable.

Pression de l'eau, Position de la buse

- La pression de l'eau (Water Pressure) et la position de la buse (Nozzle Position) sont réglables sur 5 niveaux.

Réglages de la pression de l'eau et de la position de la buse

- La pression de l'eau (Water pressure) et la position de la buse (Nozzle position) sont réglables sur 5 niveaux.

Plus faible ● ● ● ● ● Plus fort



Lumière LED

Les lampes à diodes LED s'allument dans les toilettes avec une lueur chaleureuse.

Tableau latéral

Alimentation (marche)

Appuyez sur le bouton pendant 3 secondes si vous souhaitez éteindre les toilettes.

Appuyez sur le bouton si vous souhaitez arrêter les fonctions de nettoyage « Postérieur » et « Zone intime de la femme », ainsi que la fonction de séchage.

Mode d'économie d'énergie

Sans vous asseoir sur les toilettes, appuyez une fois sur le bouton « Stop », situé sur le tableau de commande latéral, afin d'activer le mode d'économie d'énergie.

Toujours sans vous asseoir, appuyez une fois de plus sur le bouton « Stop » pour éteindre le mode d'économie d'énergie.

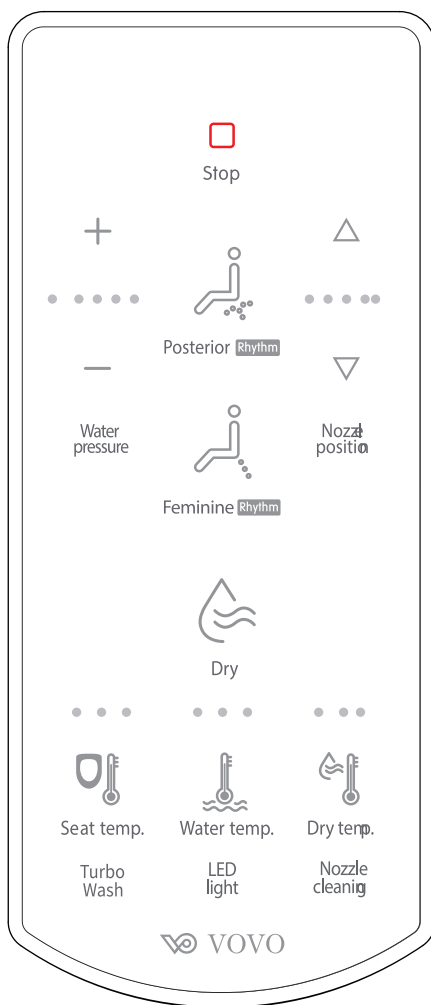

Postérieur /Nettoyage à impulsions

- Appuyez sur le bouton « Posterior/Rhythm » pour que la fonction de nettoyage du postérieur s'active.
- Appuyez de nouveau sur ce bouton durant l'utilisation de cette fonction afin d'activer celle du nettoyage à impulsions.

Zone intime de la femme /Nettoyage à impulsions

- Appuyez sur le bouton « Feminine/Rhythm » pour que la fonction de nettoyage intime de la femme s'active.
- Appuyez de nouveau sur ce bouton durant l'utilisation de cette fonction afin d'activer celle du nettoyage à impulsions.

Nettoyage turbo

- Appuyez sur le bouton « Turbo Wash » pour que la fonction de nettoyage turbo s'active.
- Le jet part de la pression d'eau la plus faible.

Température de l'eau, Température du siège, Température de séchage

- La température de l'eau (Water temp.), du siège (Seat temp.) et de séchage (Dry temp.) sont réglables sur 3 niveaux.

● basse 36°C ● moyenne 38°C ● haute 40°C

Nettoyage de la buse

- Vous pouvez nettoyer la buse en appuyant sur le bouton « Nozzle Cleaning ».

Nettoyage du postérieur / Nettoyage de la zone intime de la femme

Appuyez sur les boutons correspondant pour activer les fonctions. Si vous appuyez de nouveau sur les boutons, leur fonctionnement s'arrêtera.

Séchage (Dry)

- Appuyez sur le bouton pour activer la fonction. Si vous appuyez de nouveau sur le bouton, son fonctionnement s'arrêtera.



VB-5000SE (elongated) VB-5100SR (round)

STOP:POWER

- Press the Stop button when you want to stop the function.
- When you press the Stop button for more than 3 seconds, the power will turn off. Press the Stop button again, the power will turn on.

Kids

- Water position and nozzle pressure is set for kids use.
- Nozzle position would be set to 5th level(High) and water pressure would be set to 1st level(Low)

Water Pressure and Nozzle Position Adjustment

- Water pressure and nozzle position can be adjusted in 5 levels.

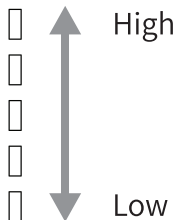

Power Saving

- The temperature of the water and the seat will be maintained at 30°C in automatic power saving mode.
- The power saving mode would be off when the user sits on the seat, and the water and seat temperature will return as user configuration.

LED Light

The LED lamps illuminate the toilet bowl with a warm glow.

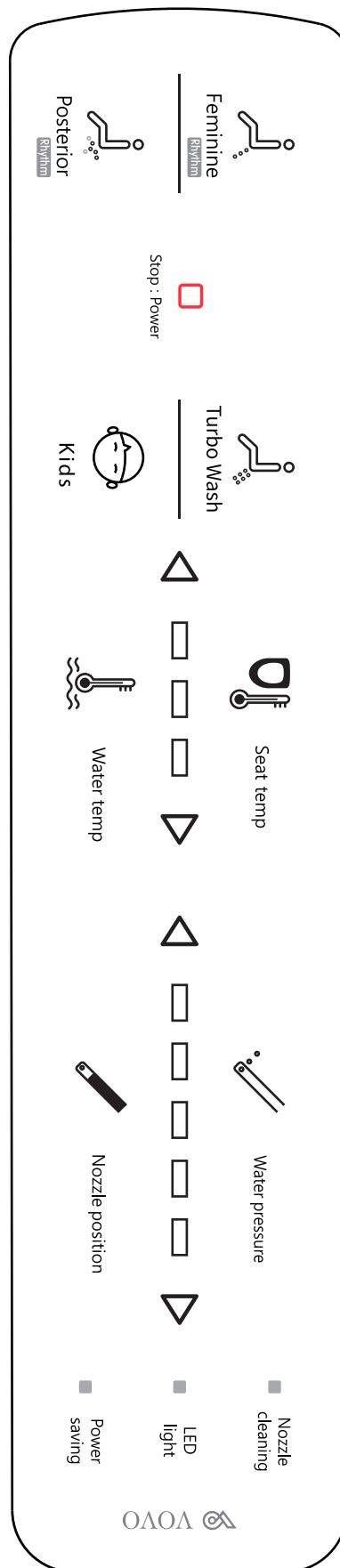

Posterior/Rhythm

- Press Posterior/Rhythm button, to operate washing function.
- Press Posterior/Rhythm button again during using this function. Rhythm(Pulsating) function will work.

Feminine/Rhythm

- Press Feminine/Rhythm button, to operate Feminine function.
- Press Feminine/Rhythm button again when during using this function, Rhythm(Pulsating) function will work.

Turbo Wash

- Press Turbo button, Turbo wash will operate.
- It starts from the lowest water pressure.

Water Temperature, Seat Temperature

- 3 levels Water Temperature / Seat Temperature

- High 104°F
- Mid 100°F
- Low 97°F

Nozzle Cleaning

- You can clean the nozzle by pressing the Nozzle cleaning button.

Manuel de l'utilisateur

VB-5000SE (modèle allongé)

VB-5100SR (modèle rond)

STOP (ARRÊT) : POWER (MARCHE)

- Appuyez sur le bouton « Stop » pour stopper le fonctionnement en cours.
- Si vous appuyez sur le bouton « Stop » pendant plus de 3 secondes, cela désactivera l'alimentation des toilettes. Appuyez de

Enfants

- Le position de la buse (Nozzle position) et la pression de l'eau (Water pressure) sont réglées pour l'usage des enfants.
- La position de la buse (Nozzle position) est réglée sur le niveau 5 et la pression de l'eau (Water pressure) sur le niveau 1.

Réglages de la pression de l'eau et de la position de la buse

- La pression de l'eau (Water pressure) et la position de la buse (Nozzle position) sont réglables sur 5 niveaux.

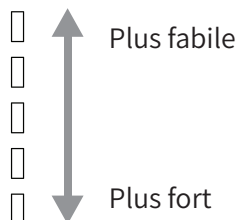

Mode d'économie d'énergie

- Les températures de l'eau et du siège sont fixées à 30°C en mode d'économie d'énergie automatique.
- Le mode d'économie d'énergie se désactive lorsque l'utilisateur s'assoit sur le siège. Les températures de l'eau et du siège reviennent selon la configuration choisie par l'utilisateur.

Lumière LED

Les lampes à diodes LED s'allument dans les toilettes avec une lueur chaleureuse.

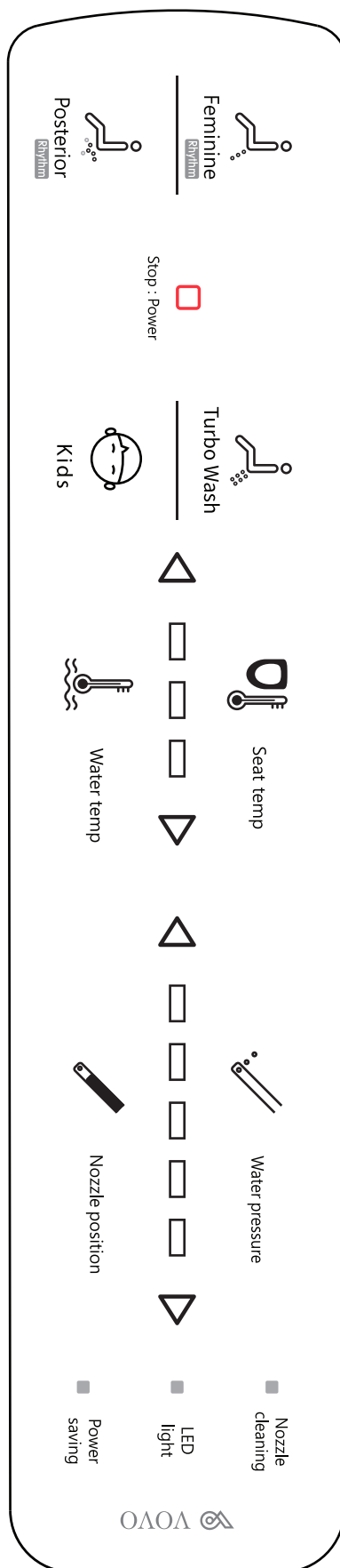

Postérieur /Nettoyage à impulsions

- Appuyez sur le bouton « Posterior/ Rhythm » pour que la fonction de nettoyage du postérieur s'active.
- Appuyez de nouveau sur ce bouton durant l'utilisation de cette fonction afin d'activer celle du nettoyage à impulsions.

Zone intime de la femme /Nettoyage à impulsions

- Appuyez sur le bouton « Feminine /Rhythm » pour que la fonction de nettoyage intime de la femme s'active.
- Appuyez de nouveau sur ce bouton durant l'utilisation de cette fonction afin d'activer celle du nettoyage à impulsions.

Nettoyage turbo

- Appuyez sur le bouton « Turbo Wash » pour que la fonction de nettoyage turbo s'active.
- Le jet part de la pression d'eau la plus faible.

Température de l'eau, Température du siège

- La température de l'eau (Water temp.) et du siège (Seat temp.) sont réglables sur 3 niveaux.

<input type="checkbox"/>	haute	40°C
<input type="checkbox"/>	moyenne	38°C
<input type="checkbox"/>	basse	36°C

Nettoyage de la buse

- Vous pouvez nettoyer la buse en appuyant sur le bouton « Nozzle Cleaning ».

VB-4000S (elongated)
VB-4100S (round)

Stop

Press the Stop button when want to stop the function.

Dry

Use this after using wash function

- Wipe off the water with toilet paper before using dry function for pleasant using.

Water Pressure, Nozzle Position

- Can control in 5 levels of water pressure and nozzle position.

Water Pressure and Nozzle Position Adjustment

- Water pressure and nozzle position can be adjusted in 5 levels.



LED Light

The LED lamps illuminate the toilet bowl with a warm glow.

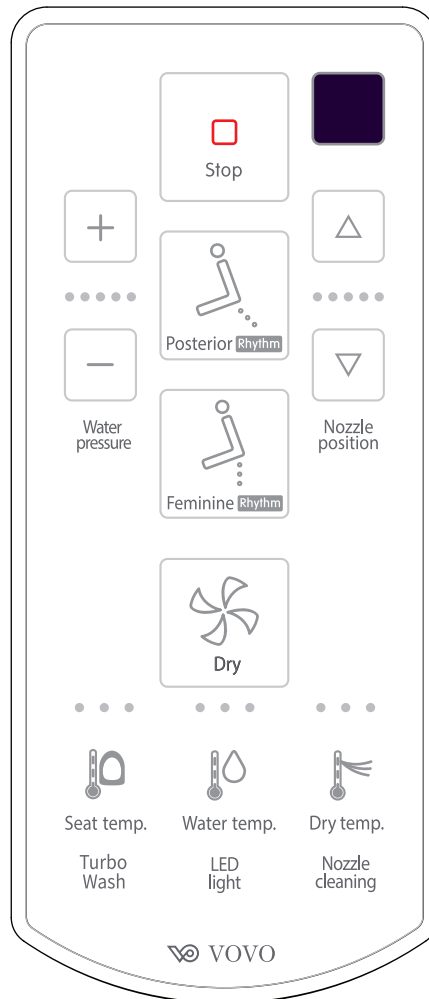

Posterior/Rhythm

- Press Posterior/Rhythm button, to operate washing function.
- Press Posterior/Rhythm button again during using this function. Rhythm(Pulsating) function will work.

Feminine/Rhythm

- Press Feminine/Rhythm button, to operate Feminine function.
- Press Feminine/Rhythm button again when during using this function, Rhythm(Pulsating) function will work.

Turbo Wash

- Press Turbo button, Turbo wash will operate.
- It starts from the lowest water pressure.

Water Temperature, Seat Temperature, Dry Temperature

- 3 levels of Water Temperature / Seat Temperature / Dry Temperature

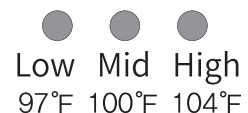

Nozzle Cleaning

- You can clean the nozzle by pressing the Nozzle cleaning button.

Side Panel

Power

Press the button for 3 seconds if you wish to turn off the bidet. Press the button if you wish to stop posterior, feminine or dry function.

Power Saving

Press the STOP button once on the side control panel of the product without seating to operate power save mode. Press the STOP button once more without seating to turn off the power save mode.

Posterior Wash / Feminine Wash

Press the button to operate the functions. The operations will stop if you press the button again.

Dry

- Press the button to operate the functions. The operations will stop if you press the button again.

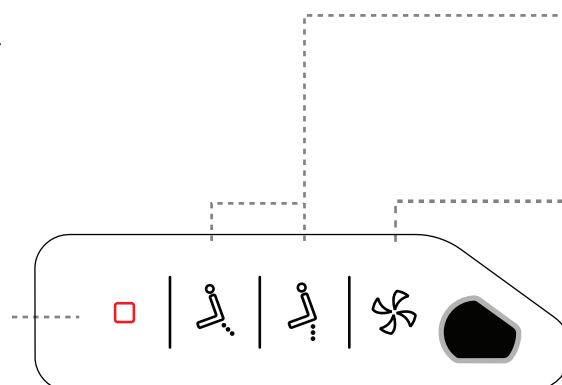

Manuel de l'utilisateur

VB-4000S (modèle allongé)

VB-4100S (modèle rond)

Stop

Appuyez sur le bouton « Stop » pour stopper le fonctionnement en cours.

Séchage (Dry)

Utilisez le séchage après avoir utilisé la fonction de lavage

- Essuyez l'eau avec du papier toilette avant d'utiliser la fonction de séchage pour un usage agréable.

Pression de l'eau, Position de la buse

- La pression de l'eau (Water Pressure) et la position de la buse (Nozzle Position) sont réglables sur 5 niveaux.

Réglages de la pression de l'eau et de la position de la buse

- La pression de l'eau (Water pressure) et la position de la buse (Nozzle position) sont réglables sur 5 niveaux.

Plus faible ● ● ● ● ● Plus fort



Lumière LED

Les lampes à diodes LED s'allument dans les toilettes avec une lueur chaleureuse.

Tableau latéral

Alimentation (marche)

Appuyez sur le bouton pendant 3 secondes si vous souhaitez éteindre les toilettes.

Appuyez sur le bouton si vous souhaitez arrêter les fonctions de nettoyage « Postérieur » et « Zone intime de la femme », ainsi que la fonction de séchage.

Mode d'économie d'énergie

Sans vous asseoir sur les toilettes, appuyez une fois sur le bouton « Stop », situé sur le tableau de commande latéral, afin d'activer le mode d'économie d'énergie.

Toujours sans vous asseoir, appuyez une fois de plus sur le bouton « Stop » pour éteindre le mode d'économie d'énergie.

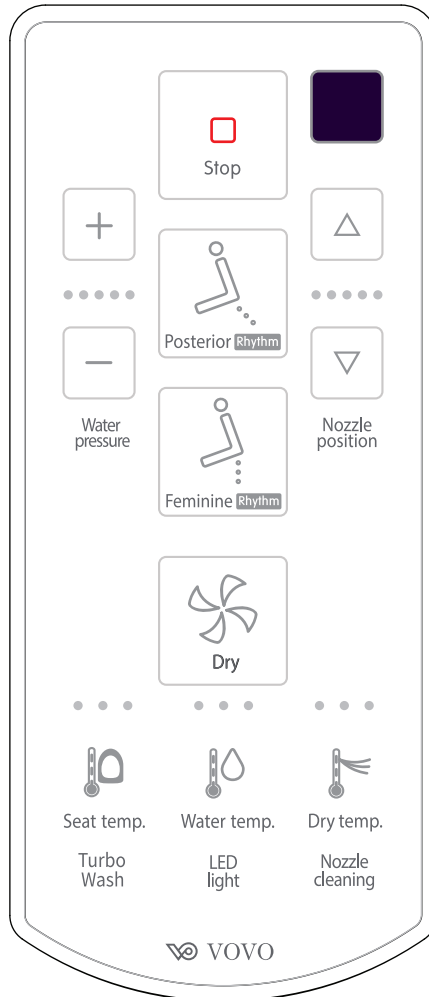

Postérieur / Nettoyage à impulsions

- Appuyez sur le bouton « Posterior/Rhythm » pour que la fonction de nettoyage du postérieur s'active.
- Appuyez de nouveau sur ce bouton durant l'utilisation de cette fonction afin d'activer celle du nettoyage à impulsions.

Zone intime de la femme / Nettoyage à impulsions

- Appuyez sur le bouton « Feminine/Rhythm » pour que la fonction de nettoyage intime de la femme s'active.
- Appuyez de nouveau sur ce bouton durant l'utilisation de cette fonction afin d'activer celle du nettoyage à impulsions.

Nettoyage turbo

- Appuyez sur le bouton « Turbo Wash » pour que la fonction de nettoyage turbo s'active.
- Le jet part de la pression d'eau la plus faible.

Température de l'eau, Température du siège, Température de séchage

- La température de l'eau (Water temp.), du siège (Seat temp.) et de séchage (Dry temp.) sont réglables sur 3 niveaux.

● basse 36°C ● moyenne 38°C ● haute 40°C

Nettoyage de la buse

- Vous pouvez nettoyer la buse en appuyant sur le bouton « Nozzle Cleaning ».

Nettoyage du postérieur / Nettoyage de la zone intime de la femme

Appuyez sur les boutons correspondant pour activer les fonctions. Si vous appuyez de nouveau sur les boutons, leur fonctionnement s'arrêtera.

Séchage (Dry)

- Appuyez sur le bouton pour activer la fonction. Si vous appuyez de nouveau sur le bouton, son fonctionnement s'arrêtera.



VB-3000S (elongated)
VB-3100S (round)

STOP:POWER

- Press the Stop button when you want to stop the function.
- When you press the Stop button for more than 3 seconds, the power will turn off. Press the Stop button again, the power will turn on.

Kids

- Water position and nozzle pressure is set for kids use.
- Nozzle position would be set to 5th level(High) and water pressure would be set to 1st level(Low)

Water Pressure and Nozzle Position Adjustment

- Water pressure and nozzle position can be adjusted in 5 levels.

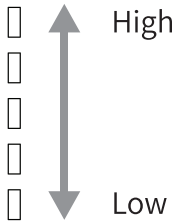

Power Saving

- The temperature of the water and the seat will be maintained at 30°C in automatic power saving mode.
- The power saving mode would be off when the user sits on the seat, and the water and seat temperature will return as user configuration.

LED Light

The LED lamps illuminate the toilet with a warm glow.

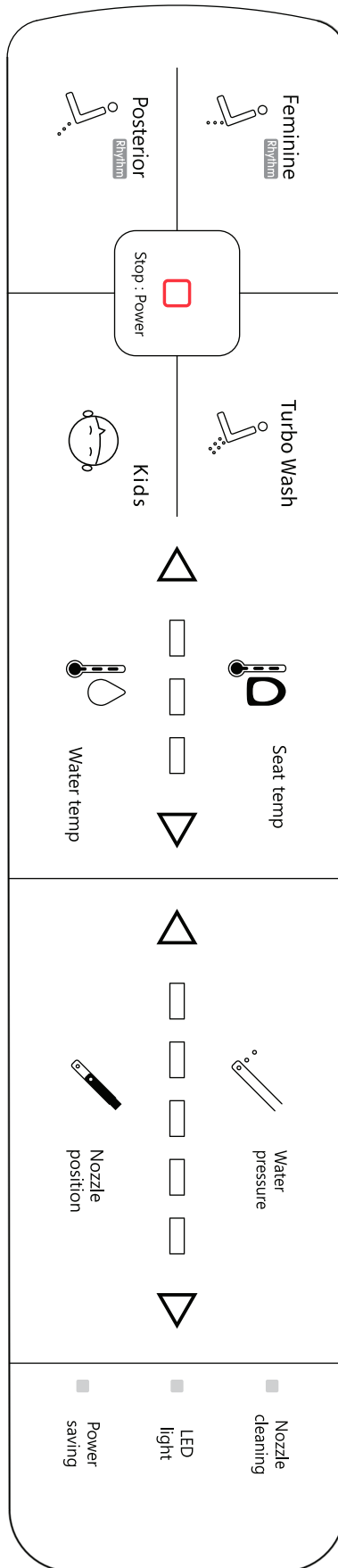

Posterior/Rhythm

- Press Posterior/Rhythm button, to operate washing function.
- Press Posterior/Rhythm button again during using this function. Rhythm(Pulsating) function will work.

Feminine/Rhythm

- Press Feminine/Rhythm button, to operate Feminine function.
- Press Feminine/Rhythm button again when during using this function, Rhythm(Pulsating) function will work.

Turbo Wash

- Press Turbo button, Turbo wash will operate.
- It starts from the lowest water pressure.

Water Temperature, Seat Temperature

- 3 levels Water Temperature / Seat Temperature

- High 104°F
- Mid 100°F
- Low 97°F

Nozzle Cleaning

- You can clean the nozzle by pressing the nozzle cleaning button.

Manuel de l'utilisateur

VB-3000S (modèle allongé)

VB-3100S (modèle rond)

STOP (ARRÊT) : POWER (MARCHE)

- Appuyez sur le bouton « Stop » pour stopper le fonctionnement en cours.
- Si vous appuyez sur le bouton « Stop » pendant plus de 3 secondes, cela désactivera l'alimentation des toilettes. Appuyez de

Enfants

- La position de la buse (Nozzle position) et la pression de l'eau (Water pressure) sont réglées pour l'usage des enfants.
- La position de la buse (Nozzle position) est réglée sur le niveau 5 et la pression de l'eau (Water pressure) sur le niveau 1.

Réglages de la pression de l'eau et de la position de la buse

- La pression de l'eau (Water pressure) et la position de la buse (Nozzle position) sont réglables sur 5 niveaux.

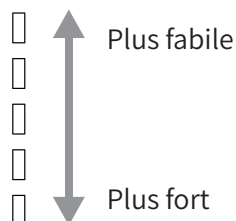

Mode d'économie d'énergie

- Les températures de l'eau et du siège sont fixées à 30°C en mode d'économie d'énergie automatique.
- Le mode d'économie d'énergie se désactive lorsque l'utilisateur s'assoit sur le siège. Les températures de l'eau et du siège reviennent selon la configuration choisie par l'utilisateur.

Lumière LED

Les lampes à diodes LED s'allument dans les toilettes avec une lueur chaleureuse.

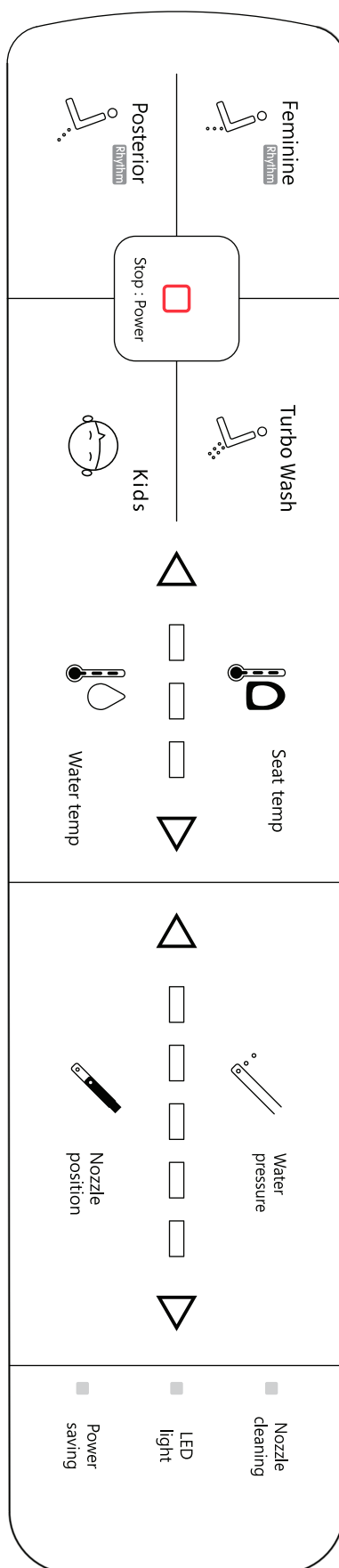

Postérieur /Nettoyage à impulsions

- Appuyez sur le bouton « Posterior/Rhythm » pour que la fonction de nettoyage du postérieur s'active.
- Appuyez de nouveau sur ce bouton durant l'utilisation de cette fonction afin d'activer celle du nettoyage à impulsions.

Zone intime de la femme /Nettoyage à impulsions

- Appuyez sur le bouton « Feminine/Rhythm » pour que la fonction de nettoyage intime de la femme s'active.
- Appuyez de nouveau sur ce bouton durant l'utilisation de cette fonction afin d'activer celle du nettoyage à impulsions.

Nettoyage turbo

- Appuyez sur le bouton « Turbo Wash » pour que la fonction de nettoyage turbo s'active.
- Le jet part de la pression d'eau la plus faible.

Température de l'eau, Température du siège

- La température de l'eau (Water temp.) et du siège (Seat temp.) sont réglables sur 3 niveaux.

<input type="checkbox"/>	haute	40°C
<input type="checkbox"/>	moyenne	38°C
<input type="checkbox"/>	basse	36°C

Nettoyage de la buse

- Vous pouvez nettoyer la buse en appuyant sur le bouton « Nozzle Cleaning ».

Maintenance

※ Unplug the power cord when cleaning the filter.

Clean the Filter

1. Turn the water supply valve clockwise to stop water supply.
2. Release the bidet hose of the main body to separate the filter.
3. Clean the filter with toothbrush or like object.
4. Tighten the bidet hose on to the main body and turn the water supply valve counterclockwise to supply water.

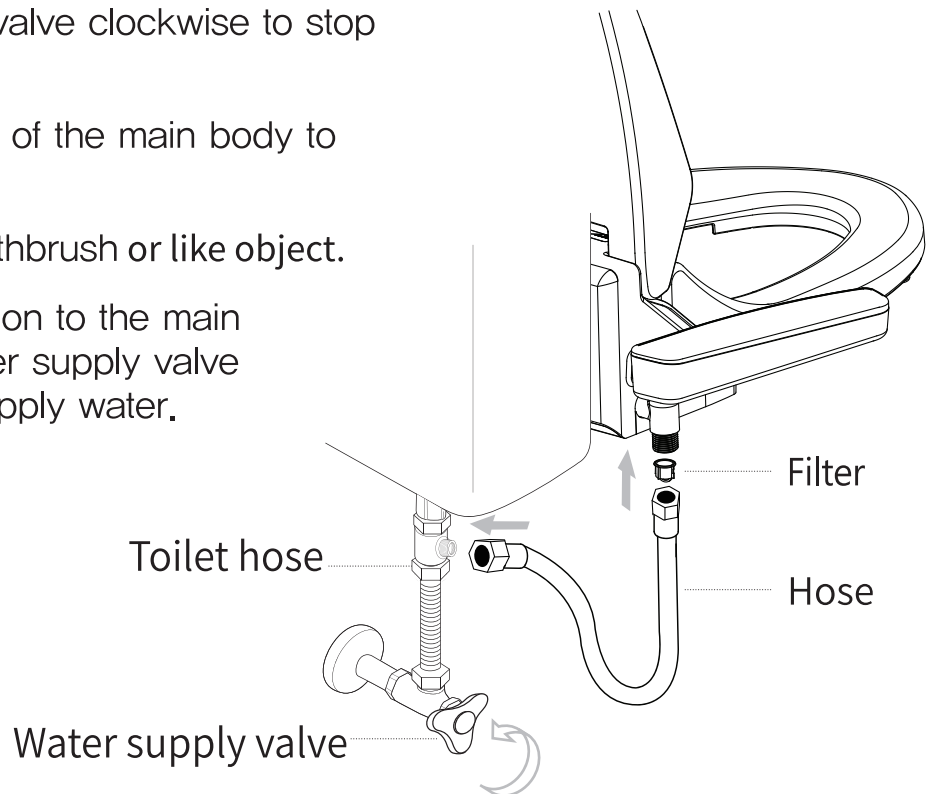

Clean the Nozzle.

Only the nozzle will extend out without spraying water.

– Use a soft brush or toothbrush to clean.



※ Do not pull out or push the nozzle forcibly. It may cause breakage or damage.



Troubleshooting

When you think the product is out of order, refer to the following for immediate measures.

Power Supply

Trouble	Possible Causes	Solution
The unit is not working.	Is the power out or is the circuit breaker off?	Wait until the power is restored. Or turn on the circuit breaker.
	Is the operation lamp on the display panel of the main body off?	Turn on the power   in the control panel of the main body.

Posterior Wash, Feminine Wash, Turbo Wash Function

Trouble	Possible Causes	Solution
Water pressure is weak.	Is the water pressure set to low level?	Adjust the water pressure to higher level.
	Is the strainer filter clogged?	Clean the strainer filter.
Water is cold.	Is the temperature set to a low level? Or is it turned off?	Adjust with Water temperature on the remote control.
	Is it in power saving mode?	The water temperature is set to lower level. the temperature goes up after sitting.
Water spray stops during use.	The washing stops 1 minute after pressing the Posterior, Feminine and Turbo button.	Press the Posterior, Feminine and Turbo button once more.
	Seat sensor is not sensing human body.	Check the position of seat sensor on page 10 to 13.

Heated Seat

Trouble	Possible causes	Solution
The seat does not warm up.	Is the temperature of the seat OFF or set to low level?	Control the seat temperature on the control panel.
	Is the bidet in Energy save mode?	The seat temperature is kept at 30°C at Energy save mode. This will automatically return to the preset temperature after seated.
The seat has become cold.	The heater turns off automatically 1 hour after you sit on the seat. When you stand up, the heater will turn on again.	—

Seat Sensor

Trouble	Possible causes	Solution
The posterior wash or deodorant function work without sitting on the seat.	Is the seat wet or occupied by wet towel?	Wipe off the water. Remove the wet towel.

Power Saving

Trouble	Possible Causes	Solution
Power saving is not working.	Is it unplugged? Did you change the batteries?	Reset the setting by pushing the power saving button from the control panel

Remote Control (VB-6000SE, VB-6100SR, VB-4000S, VB-4100S)

Trouble	Possible Causes	Solution
Remote control is not working.	Is the battery running down?	Replace old batteries with new ones.
	Is the polarity of battery misplaced?	Insert batteries in order.
	Is the transmitter, or the receiver of the remote control blocked?	Remove the objects blocking the transmitter.
	Is the transmitter, or the receiver of the remote control contaminated?	Wipe off the dust or water stain.
	Is human body out of the location of seat sensor?	Refer to the location of seat sensor on page 10 to 13.

Additional Installation Guide

Adjustment method using gap plate between pottery(toilet) and seat

When there is a gap between the inside of the seat and pottery(toilet)



Press this button to remove the bidet



1

Place the catch plate as shown



2

Combine the seat by pushing the plate



3

Minimize the gap between the bidet and the tank, and install the seat backward

When there is a gap between the outside of the seat and pottery(toilet)



Press this button to remove the bidet



1

Place the catch plate as shown



2

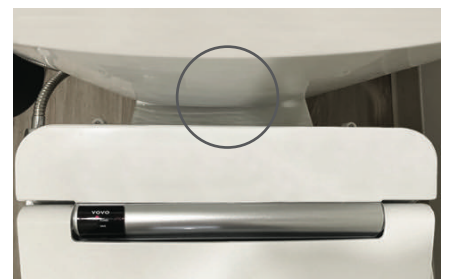

Combine the seat by pushing the plate



3

Install the seat as forward as possible

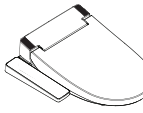
Specifications

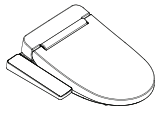
Item		Model No				
			VB-6000SE VB-6100SR	VB-5000SE VB-5100SR	VB-4000S VB-4100S	VB-3000S VB-3100S
Rated Power Supply		AC 120V, 60Hz				
Rated Power Consumption		1200W				
Water Supply System		Direct connection with tap water				
Waterproof Rating		IPX4				
Power Cord Length		1.2M (4ft)				
Wash Unit	Water Heating	Tank Reservoir				
	Posterior Wash	Maximum 800cc				
	Feminine Wash	Maximum 800cc				
	Turbo Wash	Maximum 800cc				
	Kids	—	Maximum 800cc	—	Maximum 800cc	
	Water Temperature	36°C (97°F), 38°C (100°F), 40°C (104°F)				
	Heater Capacity	1100W				
Heated Seat	Safety Device	Thermal cutoff, Thermo Switch, Water Level Sensor				
	Seat Temperature	36°C (97°F), 38°C (100°F), 40°C (104°F)				
	Heater Capacity	Maximum 55W				
Dry (Except VB-5000SE VB-5100SR VB-3000S VB-3100S)	Safety Device	Thermal Cutoff, Temperature Sensor, Bimetal				
	Warm Air Temperature	Room temperature - maximum 45°C(113°F)				
	Heater Capacity	Maximum 250W				
Lighting		LED light				
Inlet Water Temperature		5°C~35°C (41°F~95°F)				
Ambient Temperature		5°C~35°C (41°F~95°F)				
Country of Origin		Made in Korea				
Dimension		20.8X15X5.1 in (elongated) 19.8X15X 5.1 in (round)	20.8X18.4 X 5.1 in (elongated) 19.8X18.4 X 5.1 in (round)	20.8X15X5.1 in (elongated) 19.8X15X 5.1 in (round)	20.8X18.4 X 5.1 in (elongated) 19.8X18.4 X 5.1 in (round)	
Net Weight (Gross Weight)		8.3 lb (13.2 lb) 7.2 lb (12 lb)	8.8 lb (13.6 lb) 7.7 lb (12.5 lb)	8.3 lb (13.2 lb) 7.2 lb (12 lb)	8.8 lb (13.6 lb) 7.7 lb (12.5 lb)	

Limited Warranty

The product is warranted for one year according to the description written in this warranty.

Please submit the below form online at www.vovousa.com.

Model :		Serial Number :	
Purchaser			
Company :			
Address :			
City :		Country :	
Phone :		Fax :	E-mail :
Dealer (Company)			
Address :			
Installation Date :		Warranty period	
		1 year from purchase date	

Complete the above warranty card when purchasing the product. Check the information and keep it safe.

This warranty does not apply to the following

1. Defects and/or malfunctions from failure to properly install, operate and/or maintain the unit in accordance with the installation manual.
2. Damage from abuse, fire, flood, freeze, electrical surges, lightning strikes or any other acts of nature.
3. Damage resulting from unauthorized alterations, attachments and/or repairs.
4. If the product was not installed properly for residential use.
5. Damage from installing the unit in an environment with animals, mice or insects .
6. Damage caused by excess moisture or from water clogging the water closet.
7. Damage from not being installed in accordance with all applicable local codes, ordinances and good trade practices.
8. Color fading due to use in wrong environment.
9. Damage from consumable chemicals.
10. The warrant will be covered only when providing the date of purchase with original receipt.
11. Damage from misuse due to not following the installation manual.



VOVO WARRANTY
ONE YEAR LIMITED WARRANTY
WATERJET BIDET PRODUCT

1.VOVO is proud to guarantee all our products with the longest, most complete coverage warranty in the electronic bidet world. Our policies are written in more detail below.

2.This warranty does not apply to the following items:

- a. Damage or loss sustained in through any natural or man-made caused beyond the control of VOVO including to fire, earthquake, flood, thunder, electrical storm, etc.
- b. Damage or loss resulting from any accident, unreasonable use, misuse, abuse, negligence, or improper care, cleaning, or maintenance of the Product.
- c. Damage or loss resulting from sediments or foreign matter contained in a water system.
- d. Damage or loss resulting from improper installation or from installation of the Product in a harsh and/or hazardous environment, or improper removal, repair or modification of the Product.
(NOTE: Product model codes allow a maximum of 80 PSI. Check local codes or standards for requirements).
- e. Damage or loss resulting from electrical surges or lightning strikes or other acts which are not the fault of VOVO or which the Product is not specified to tolerate.
- f. Damage or loss resulting from normal and customary wear and tear, such as gloss reduction, scratching or fading over time due to cleaning practices, water or atmospheric condition, including but not limited to, the use of bleach, alkali, acid cleaners, dry (powder) cleaners or any other abrasive cleaners or the use of metal or nylon scrubbers.
- g. The use of any Product in a manner inconsistent with the Product instructions / owners manual.

3. In order for this limited warranty to be valid, proof of purchase is required. VOVO encourages warranty registration upon purchase to create a record of Product ownership at <http://www.vovouusa.com> Product registration is completely voluntary and failure to register will not diminish your limited warranty rights.

4. THIS WARRANTY GIVES YOU SPECIFIC LEGAL RIGHTS. YOU MAY HAVE OTHER RIGHTS WHICH VARY FROM STATE TO STATE, PROVINCE TO PROVINCE OR COUNTRY TO COUNTRY.

5. To obtain warranty repair service under this warranty, you must take the Product or deliver it prepaid to a VOVO service facility together with proof of purchase (original sales receipt) and a letter stating the problem, call (888)601-0177 or email to support@vovouusa.com.

WARNING! VOVO shall not be responsible or liable for any failure of, or damage to, this Product caused by either chloramines in the treatment of public water supply or cleaners containing chlorine (Calcium Hypochlorite).

NOTE: The use of high concentrate chlorine or chlorine related products can seriously damage the fittings. This damage can cause leakage and serious property damage.

THIS WRITTEN WARRANTY IS THE ONLY WARRANTY MADE BY VOVO. REPAIR, REPLACEMENT OR OTHER APPROPRIATE ADJUSTMENT AS PROVIDED UNDER THIS WARRANTY SHALL BE THE EXCLUSIVE REMEDY AVAILABLE TO THE ORIGINAL PURCHASER. VOVO SHALL NOT BE RESPONSIBLE FOR LOSS OF THE PRODUCT OR FOR OTHER INCIDENTAL, SPECIAL OR CONSEQUENTIAL DAMAGES OR EXPENSES INCURRED BY THE ORIGINAL PURCHASER, OR FOR LABOR OR OTHER COSTS DUE TO INSTALLATION OR REMOVAL, OR COSTS OF REPAIRS BY OTHERS, OR FOR ANY OTHER EXPENSE NOT SPECIFICALLY STATED ABOVE. IN NO EVENT WILL VOVO'S RESPONSIBILITY EXCEED THE PURCHASE PRICE OF THE PRODUCT. EXCEPT TO THE EXTENT PROHIBITED BY APPLICABLE LAW, ANY IMPLIED WARRANTIES, INCLUDING THAT OF MERCHANTABILITY OR FITNESS FOR USE OR FOR A PARTICULAR PURPOSE, ARE EXPRESSLY DISCLAIMED. SOME STATES DO NOT ALLOW LIMITATIONS ON HOW LONG AN IMPLIED WARRANTY LASTS, OR THE EXCLUSION OR LIMITATION OF INCIDENTAL OR CONSEQUENTIAL DAMAGES, SO THE ABOVE LIMITATION AND EXCLUSION MAY NOT APPLY TO YOU.

MEMO



VOVO USA

377 Van Ness Way Suite 1205-1206, Torrance, CA 90501
Tel. +1.310.601.7798 | Fax. +1-424.399.5081
Customer Support. +1-888-601-0177

Factory

6173-21, Seodong-daero, Samjuk-myeon, Anseong-si, Gyeonggi-do, Republic of Korea
Tel. +82-31-672-0634, 0635 / Fax. +82-31-672-0630

www.vovousa.com