



✳ Please register your product at
www.vovo-us.com/pages/register
★ to receive full warranty benefit.★

- TCB 090SA
- TCB 090S
- RTB 090WA
- RTB 090W
- PB-707S
- PB-101S
- TCB 8100B
- TCB 8100W

If the product you receive has **CRACKED** during the transportation,
Please send us photos and order ID to support@vovousa.com

You will receive :

FULL REFUND or NEW REPLACEMENT

You will enjoy 100% satisfactory service.
support@vovousa.com

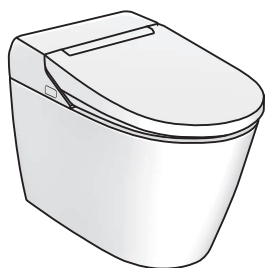
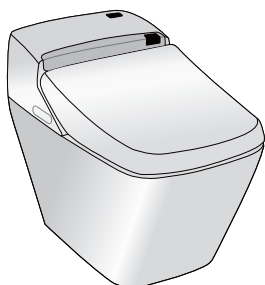

Contents

Preparation

Important Safety Instructions	2
Cautions for Safety	4
Grounding Instructions	6
Name of Parts	8

Installation method

Installation method	11
Preparation and Check before Use	14

How to use

Proper Usage	16
Remote Control (TCB 090SA, TCB 090S)	17
Remote Control (RTB 090WA, RTB 090W)	23
Remote Control (TCB 8100B, TCB 8100W)	29
How to use	32
Remote Control (PB-707S, PB-101S)	33
How to use	36

Others

Maintenance	39
FAQ	40
Troubleshooting	41
Customer Support	45
Specifications	46
Warranty	47
VOVO Warranty	48

To Our Customers

- Thank you for choosing VOVO bidet.
- For your own safety, please read this user manual carefully.
- Please refer to this manual if you have any questions while in use.
- We are not responsible for the accidents from the user's negligence.
- Product warranty is included in this manual. Be careful not to lose it.
- If you have well water system, please contact us before installation.

E-mail : support@vovousa.com



IMPORTANT SAFETY INSTRUCTIONS

When using electric appliances, especially when children are present, basic safety precautions should always be followed, including the following

READ ALL INSTRUCTIONS BEFORE USING

DANGER - As with most electric appliances, electrical parts are electrically live even when switch is off. To reduce the risk of death by electric shock:

1. Do not use while bathing
2. Do not place or store appliance when it can fall or be pulled into a tub or sink
3. Do not place in or drop into water or other liquid.
4. If an appliance falls into water, unplug it immediately. Do not reach into the water.

WARNING - To reduce the risks of burns, electrocution, fire or injury to persons

1. Close supervision is necessary when this appliance is used by, on, or near children
2. Use this appliance only for its intended use as described in this manual. Do not use attachment not recommended by the manufacturer.
3. Never operate this appliance if it has a damaged cord or plug, if it is not working properly, or it has been dropped, damaged, or dropped into water. Return the appliance to a service center for examination and repair.
4. Keep the cord away from heated surfaces. Do not wrap the cord around the appliance.
5. Never block the air openings of the appliance or place it on a soft surface, such as a bed or couch, where the air openings may be blocked. Keep the air openings free of lint, hair, and the like.
6. Never use while sleeping
7. Never drop or insert any object into any opening or hose.
8. Do not use outdoors or operate where aerosol (Spray) products are being used or where oxygen is being administered.
9. Do not use an extension cord with this appliance.
10. Use this appliance only for household use
11. Connect this product to a properly grounded outlet only. See Grounding Instructions.

SAVE THESE INSTRUCTIONS



CONSIGNES DE SÉCURITÉ IMPORTANTES

Lors de l'utilisation d'appareils électriques, en particulier lorsque des enfants sont présents, des précautions de sécurité de base doivent toujours être suivies, y compris les suivantes

LISEZ TOUTES LES INSTRUCTIONS AVANT L'UTILISATION

DANGER - comme pour la plupart des appareils électriques, les pièces électriques sont électriquement actives même lorsque l'interrupteur est éteint.

Pour réduire le risque de décès par électrocution:

1. Ne pas utiliser pendant le bain.
2. Ne pas placer ni ranger l'appareil électrique dans un endroit où il peut tomber ou être tiré dans une baignoire ou un évier.
3. Ne pas placer ou le déposer dans l'eau ou autre liquide.
4. Si un appareil tombe dans l'eau, débranchez-le immédiatement. Éviter de toucher l'eau.

ATTENTION - Pour réduire le risque de brûlures, d'électrocution, d'incendie ou de blessure pour les personnes.

1. Une surveillance étroite est nécessaire lorsque cet appareil est utilisé par, sur ou près des enfants ou de personnes invalides.
2. Utilisez l'appareil uniquement pour l'utilisation prévue, comme décrit dans ce manuel.
N'utilisez pas des pièces jointes non recommandée par le fabricant.
3. N'utilisez jamais cet appareil s'il a un cordon ou une fiche endommagée, s'il ne fonctionne pas correctement, ou il a tombé, endommagé ou tombé dans l'eau. Renvoyer l'appareil à un centre de service pour examen et réparation.
4. Gardez le cordon loin des surfaces chaudes. Ne pas enrouler le cordon autour de l'appareil.
5. Ne jamais bloquer les ouvertures d'air de l'appareil ou le placer sur une surface douce, comme un lit ou un divan, où les ouvertures d'air peuvent être bloquées. Gardez les ouvertures d'air exemptes de peluches, de cheveux et autres.
6. Ne jamais l'utiliser en dormant.
7. Ne le faites pas tomber ou insérez un objet dans une ouverture ou un tuyau.
8. Ne pas l'utiliser à l'extérieur ou l'opérer dans un endroit où des produits en aérosol sont pulvérisés ou de l'oxygène est administré.
9. N'utilisez pas de rallonge avec cet appareil.
10. Utiliser cet appareil uniquement pour l'usage domestique.
11. Connectez ce produit à une prise de courant correctement mise à la terre uniquement. Voir les instructions de mise à la terre.

CONSERVER CES INSTRUCTIONS

Cautions for Safety

Read all instructions before installation and use.

This manual contains important precautions and operating instructions for your own safety.



Danger The following points indicate an imminently hazardous situation which, if not avoided, will result in death or serious injury.

This is an electric appliance. Do not install the product in a place where the product is exposed to splash of water or humidity such as dew formation. When installing the product in the bathroom with bathtub, install ventilator to facilitate ventilation.



Prohibited



Do not use damaged cord, plug, consent and do not connect power while no water supply.

– It can cause short circuit, fire or electric shock.



Handle power cord carefully and do not bend or pull it forcibly.

– It can cause fire or electric shock.

– It can cause water leakage from the main body of piping.

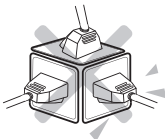

Do not use loose or unstable outlet and do not exceed the rated voltage of the outlet or the distributor.

– It can cause fire or electric shock.



Do not step on, shock, or place heavy objects on the seat, cover, or main body.

– You can hurt yourself.

– It can cause breakage or damage.

– It can cause water leakage through broken toilet.



Do not spray water



Do not splash water or detergent on the main body or power plug.

– It can cause fire or electric shock.



Wet hand prohibited

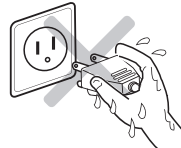

Do not touch the power cord with wet hands.

– It can cause electric shock.



Fire prohibited



Do not place fire such as cigarette near the product.

– It can cause fire, electric shock or injury.



Do not disassemble



Do not open the product to repair or remodel.

Only qualified service person should service this product.

– It can cause fire, electric shock or malfunction.



Grounding

■ **Make sure the product is properly grounded.**

– If the product is not grounded, it can cause electric shock or electric leakage.

– For grounding work, consult an electric technician nearby.



Observe strictly

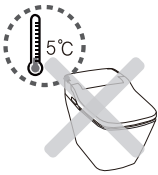

Do not use damaged cord, plug, consent and do not connect power while no water supply.

– It can cause short circuit, fire or electric shock.



When installing the strainer, connect it tightly.

– Otherwise, it can cause water leakage.
– When water leaks, close the shutoff valve to stop water supply. (Turn the valve clockwise with screwdriver.)



Do not place hand or clothes on the warm air outlet.

– It can cause burn, electric shock or fire.

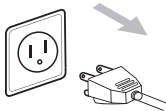

Unplug the main power cable when you fix it.

– It can cause electric shock.

■ **Do not use industrial water or graywater for water supply.**

– It can cause dermatitis.
– It can cause malfunction because of pollutant in water.



Warning

The following points indicate dangerous situations where the user could suffer or sustain material damages if this product is used incorrectly.

Do not use for other purposes than reported in this manual.



Prohibited



Do not throw anything else than a toilet paper in the toilet.

– Toilet can be clogged and it can cause the backflow of wastewater.
– Be careful not to drop anything into the toilet bowl.



Observe strictly



Make sure urine doesn't splash on to the nozzle and outlet of air vent.

– It can cause stinky odor and malfunction.



**When cleaning, use mild detergent with soft cloth and do not use the following
(bathroom detergent, household detergent, benzene, paint thinner, nylon scrubber)**

– It can cause breakage.

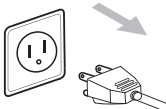

Unplug the main power cable when not using the product for a long time.

– It can cause malfunction.

- There is concern in minor burns with heated seat.
- Anti-burning system will operate when the user is sitting on the seat for a long time.
- Turn off the seat temperature when the user is sitting on the seat for a long time.
- Turn off the seat temperature and dry temperature in the following cases.
 - Children, Seniors, and People who can't control the product.
 - Patients and disabled people.
 - People who take sleeping pills or medicine.
 - People who are drunk or exhausted.

GROUNDING INSTRUCTIONS

1. This product should be grounded. In the event of an electrical short circuit, grounding reduces the risk of electric shock by providing an escape wire for the electric current. This product is equipped with a cord having a grounding wire with a grounding plug. The plug must be plugged into an outlet that is properly installed and grounded.

DANGER - Improper use of the grounding plug can result in a risk of electric shock

If repair or replacement of the cord or plug is necessary, do not connect the grounding wire to either flat blade terminal. The wire with insulation having an outer surface that is green with or without yellow stripes is the grounding wire.

Check with a qualified electrician or serviceman if the grounding instructions are not completely understood, or if in doubt as to whether the product is properly grounded.

2. This product is for use on a nominal 120 V circuit, and has a grounding plug that looks like the plug illustrated in sketch A in Figure 1. A temporary adapter, which looks like the adapter illustrated in sketches B and C, may be used to connect this plug to a 2-pole receptacle as shown in sketch B if a properly grounded outlet is no available. The temporary adapter should be used only until a properly grounded outlet (sketch A) can be installed by a qualified electrician. The green colored rigid ear, lug, and the like extending from the adapter must be connected to a permanent ground such as a properly grounded outlet box cover. Whenever the adapter is used, it must be held in place by the screw.

3. If it is necessary to use an extension cord, use only a three wire extension cord that has a three-blade grounding plug, and a three-slot receptacle that will accept the plug on the product. Replace or repair a damaged cord.

4. This product is factory equipped with a specific electronic cord and plug to permit connection to a proper electronic circuit. Make sure that the product is connected to an outlet having the same configuration as the plug. No adapter should be used with this product. Do not modify the plug provided-if not, will not fit the outlet, have the proper outlet installed by a qualified electrician, if the product must be reconnected for use on a different type of electronic circuit, the reconnection should be made by qualified service personnel.

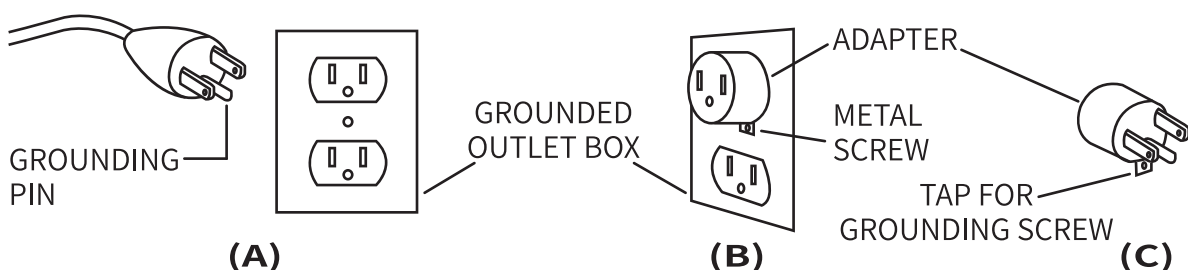

Figure 1.

Instructions de mise à la terre

1. Ce produit doit être mis à la terre. En cas de court-circuit électrique, la mise à la terre réduit le risque de choc électrique en fournissant un fil d'échappement pour le courant électrique. Ce produit est équipé d'un cordon ayant un fil de mise à la terre avec une fiche de mise à la terre. La fiche doit être branchée sur une prise correctement installée et mise à la terre.

DANGER - L'utilisation incorrecte de la fiche de mise à la terre peut entraîner un risque de choc électrique.

Si une réparation ou le remplacement du cordon ou de la fiche est nécessaire, ne connectez pas le fil de mise à la terre sur une borne à plat. Le fil avec l'isolant ayant une surface extérieure en vert avec ou sans rayons jaunes est le fil de mise à la terre.

Vérifiez auprès d'un électricien ou d'un technicien qualifié si les instructions de mise à la terre ne sont pas complètement comprises, ou si vous avez des doutes quant à savoir si le produit est correctement mis à la terre.

2. Ce produit est destiné à être utilisé sur un circuit nominal de 120 V et possède une fiche de mise à la terre qui ressemble à la fiche illustrée dans le croquis A de la Figure 1. Un adaptateur temporaire, qui ressemble à l'adaptateur illustré dans les croquis B et C, peut être utilisé pour connecter cette fiche à un réceptacle à 2 pôles comme indiqué dans le croquis B si une prise de courant correctement mise à la terre n'est pas disponible. L'adaptateur temporaire doit être utilisé uniquement jusqu'à ce qu'une prise de courant correctement mise à la terre (croquis A) puisse être installée par un électricien qualifié. L'oreille (La languette) rigide de couleur verte, le crochet, et les autres éléments similaires qui s'étendent de l'adaptateur doivent être connectés à un sol permanent tel qu'un couvercle de la boîte de sortie correctement mis à la terre. Chaque fois que l'adaptateur est utilisé, il doit être maintenu en place par une vis.
3. S'il est nécessaire d'utiliser une rallonge, utilisez uniquement un cordon de rallonge à trois fils doté d'une fiche de mise à la terre à trois lames et une prise à trois logements qui acceptera la fiche du produit. Remplacez ou réparez un cordon endommagé.
4. Ce produit est équipé en usine d'un cordon électronique spécifique et d'une prise pour permettre la connexion à un circuit électronique approprié. Assurez-vous que le produit est connecté à une prise de courant ayant la même configuration que la fiche. Aucun adaptateur ne doit être utilisé avec ce produit. Ne modifiez pas la fiche fournie - si elle ne correspond pas à la sortie, installez la prise appropriée par un électricien qualifié, si le produit doit être reconnecté pour une utilisation sur un autre type de circuit électronique, la reconnexion doit être faite par un personnel qualifié.

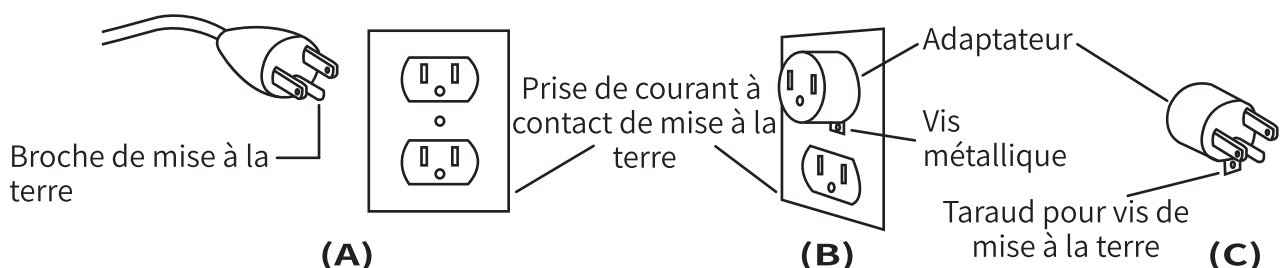
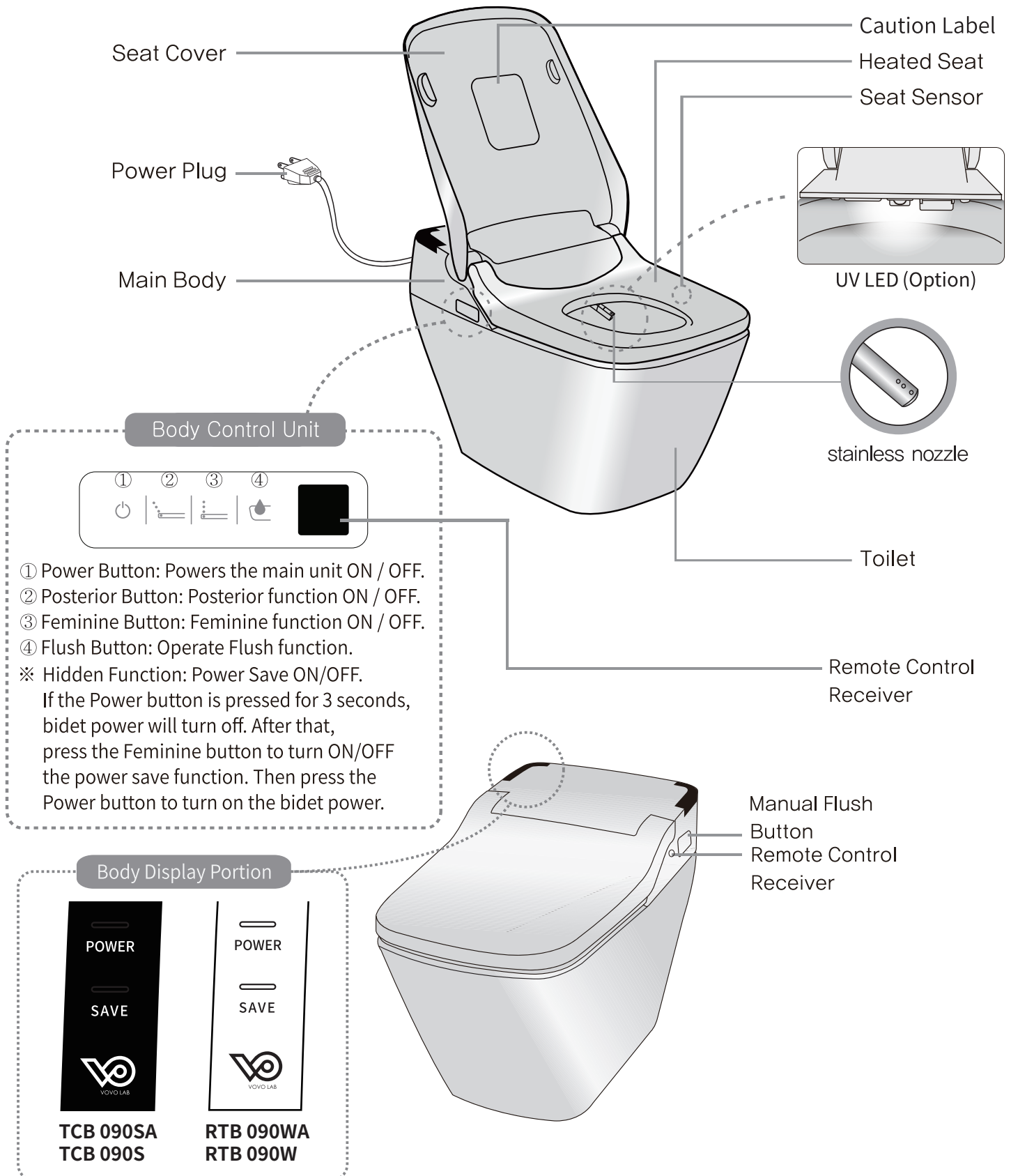

Figure 1.

Names of Parts

- TCB 090SA / TCB 090S
- RTB 090WA / RTB 090W





Names of Parts

- PB-707S / PB-101S

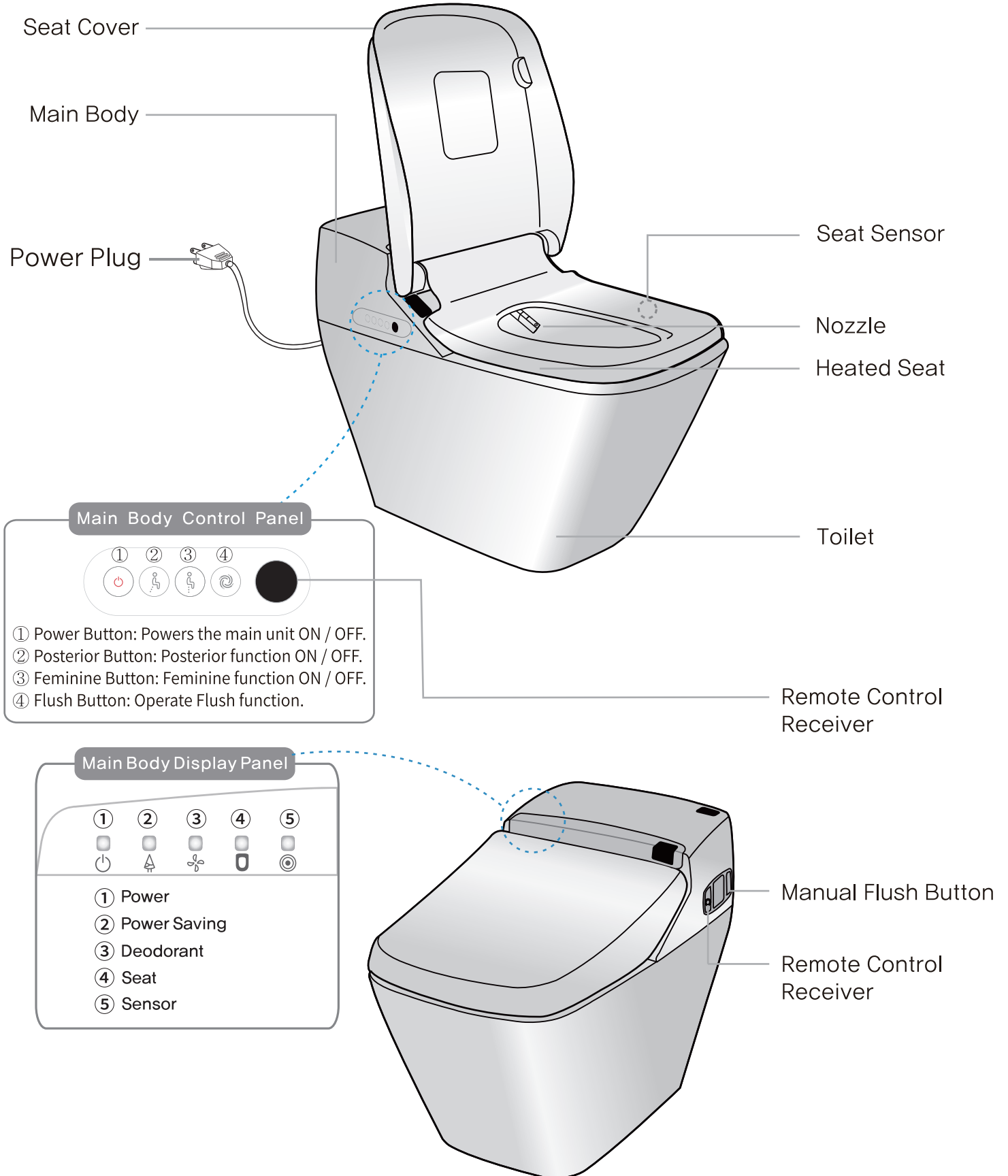

Names of Parts

- TCB 8100B / TCB 8100W

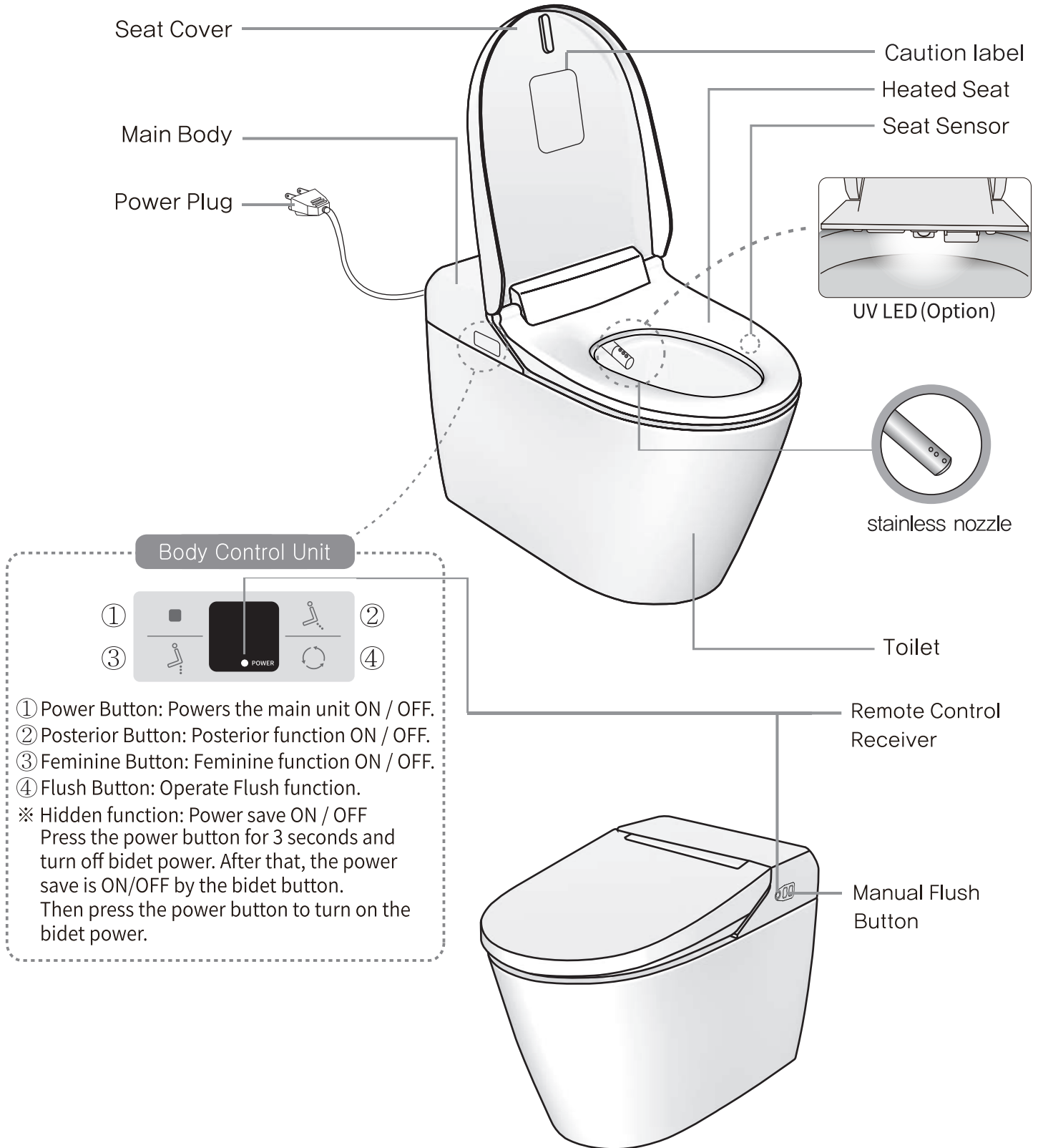

Installation Method

The below images may be different with the actual products.

1 Cautions before Installation (This may differ from the product specification.)

Installation • Secure enough installation space in the bathroom and check whether it disturbs the bathroom door.

Space – Secure water outlet at least 100mm away from the floor. * If you have shorter rough in than 11", you can use an offset flange for installation.
– It can cause the discoloration of wall.

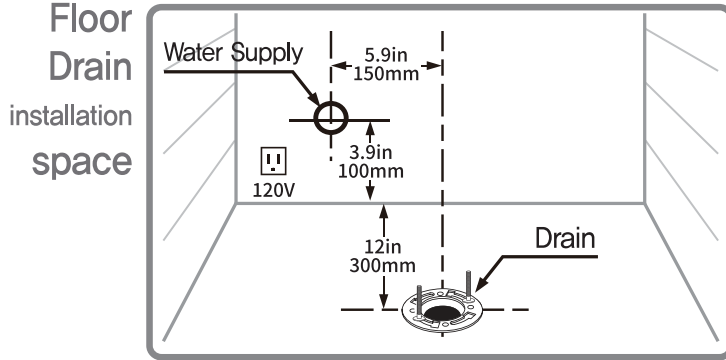

- **Water Pressure**
 1. Minimum 1.5 kgf/cm² (STATIC 40PSI) water pressure is required. If the pressure is not secured, please be aware that the flushing may not work properly to discharge the dirt.
 2. Even if other modifiers are used at the same time, it still requires more than the minimum required water pressure. The maximum water pressure is 7.5 kgf/cm² (STATIC 75PSI).

※ Extract bad water before install

1. Direct the supply hose end into a 3 gal (11.4l) or larger bucket.
2. Make sure that the supply stop can provide a minimum of 1.5gal (5.7l) or more in 10 seconds.
3. Shut off the water supply.

Proceed to next step

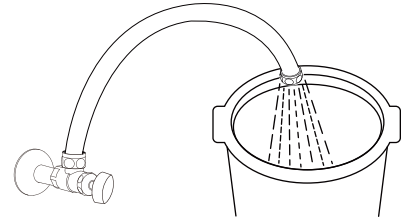

2 Drawing for Installation (unit : mm / in)

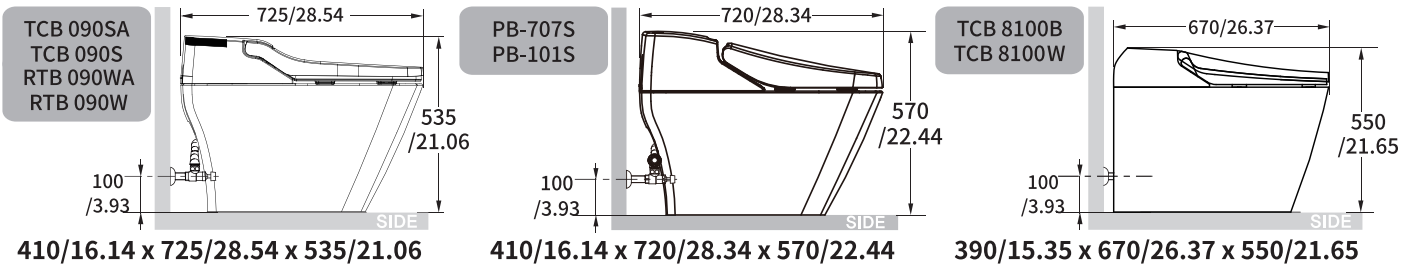

3 FAQ

Q: What is electrical requirements? Is it energy efficient?
A: 6 Amps at 120V, 60 Hz is necessary for this item.
 A separate circuit breaker is recommended.
 It has a power save mode which uses least amount of energy.

Q: Power save LED light is keep flashing. (Turned off and on)
A: Please open the valve, please check the water has entered to the bidet. If it still flashes, please try reset.
(Unplug the cord and plug it back after 30 seconds)

Q: How long is the cord?
A: 4ft (1.2m).

4 Installation Accessories

1 A type Installation Accessories (Standard)

★ Recommended installation method ★
 ★ Requires installation by plumber ★

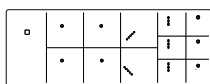

Remote control
Each product may use a different remote controller.



Wall Mount



Wax Ring



Ring Plate



AA Batteries (x3)



Water Pipe



Screws (x2)

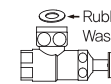

Rubber Washer



Anchors (x2)



Water Shutoff Valve (1/2" x 5/8")



Strainer Filter (5/8" x 5/8")

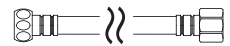

Water Hose (Thicker) (1" x 5/8")

2 B type Installation Accessories

If type A installation is inconvenient, please install type B.

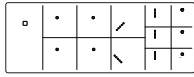

Remote control
Each product may use a different remote controller.



Wall Mount



Conversion Nut

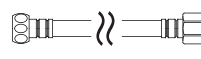

Water Hose
(Thin)
(1" x 1/2")



Wax Ring



AA Batteries (x3)



Screws (x2)



Anchors (x2)

5 Installation (This may differ from the product specification.)

1 A type Installation (Standard)

1. Close the water gauge.
2. Remove dust and sand in the water inlet when installing the shutoff valve.
3. Wind Teflon tape around the water pipe.
4. Connect the pipe with the shutoff valve.
5. Connect the Strainer Filter.

※ Please do not connect like below ※

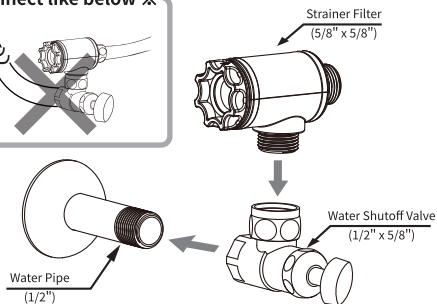
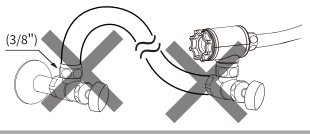

1-2 B type Installation Accessories

- Attach the provided water hose to your water shutoff valve.

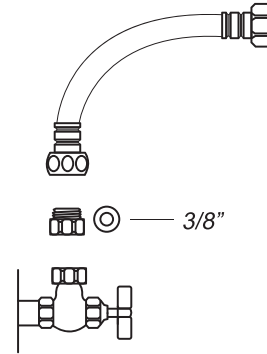

*You may need to use the included conversion nut to fit your water shutoff valve.
Simply screw the conversion nut into the 1/2" side of the hose before connecting it to your water shutoff valve.

2 How to install the Ceramic

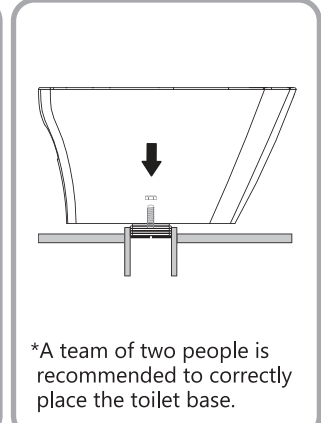
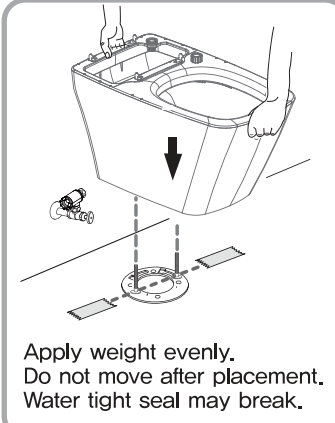
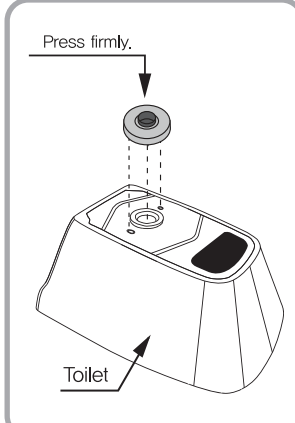
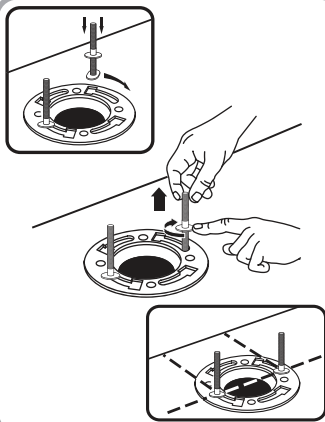

*A team of two people is recommended to correctly place the toilet base.

3 Connect Hose

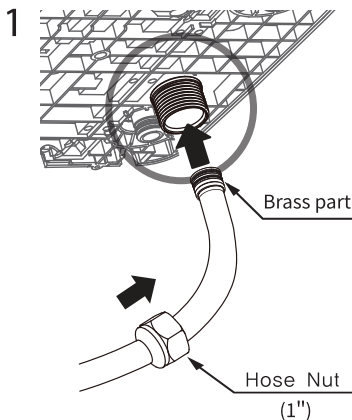

1. Insert the brass part to the flushing outlet first.

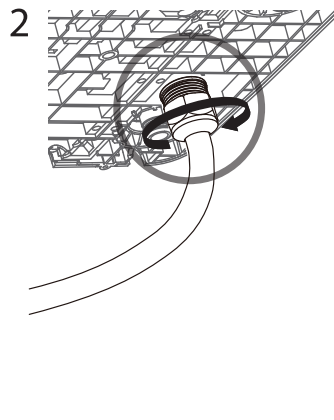

2. Turn the nut clockwise to tighten the hose.

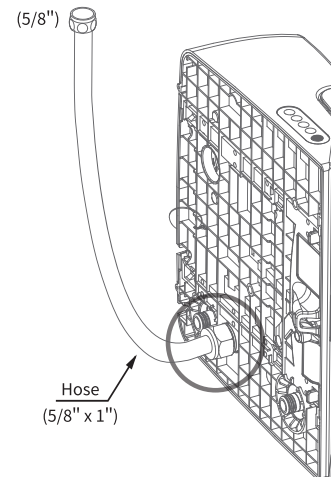

④ Connect Bidet to Toilet

1. Assemble the toilet with bidet, jet spray outlet and bowl washing outlet.
2. Insert the hose into the filter.
3. Insert bidet's fixing hook onto the toilet's fixing hook until it "clicks".

A type (Standard)

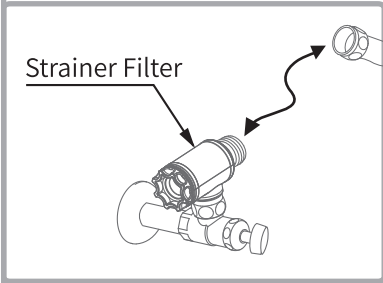

B type

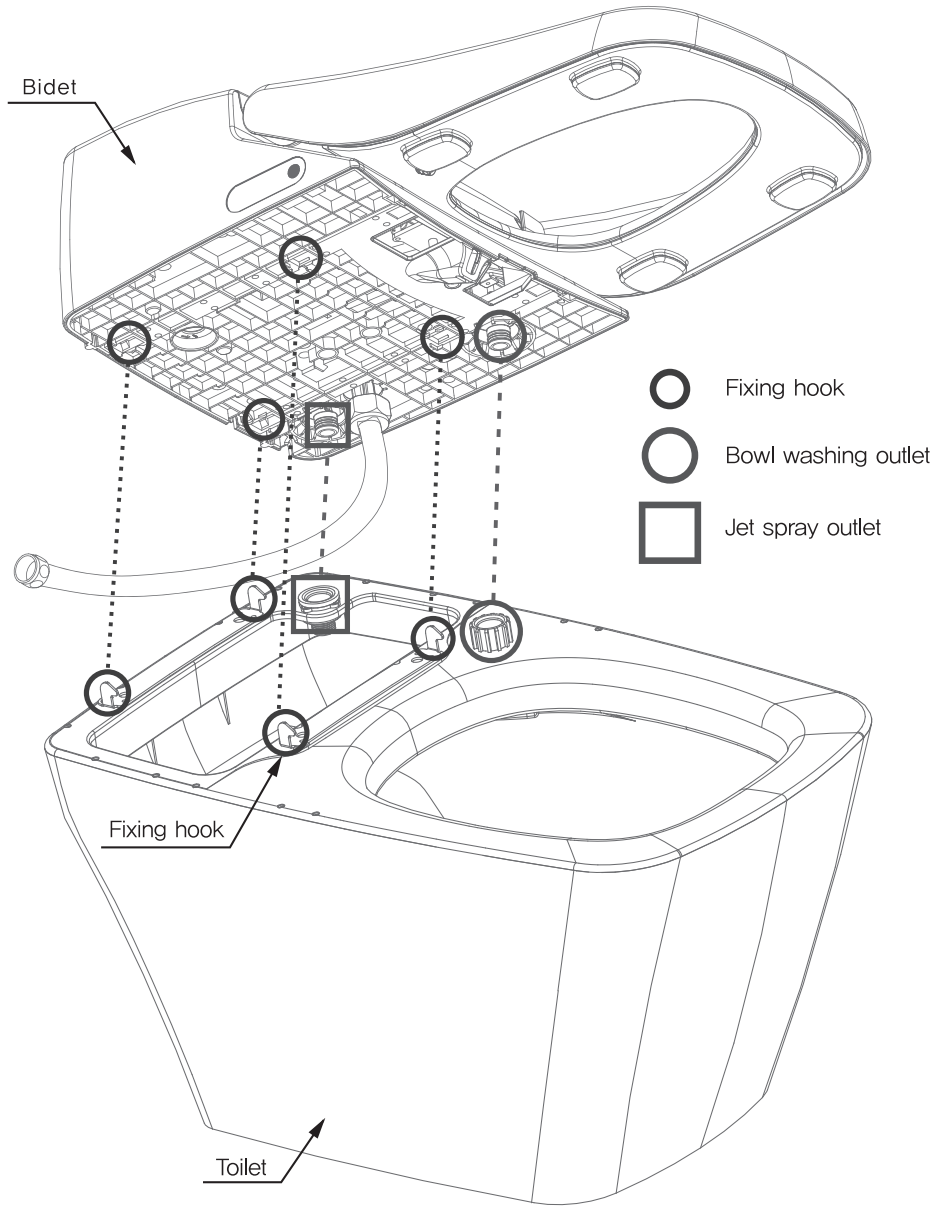
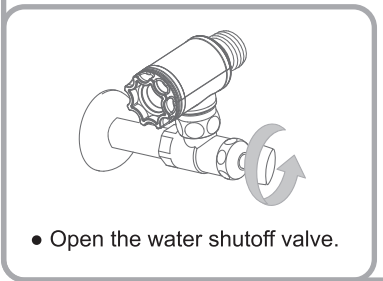
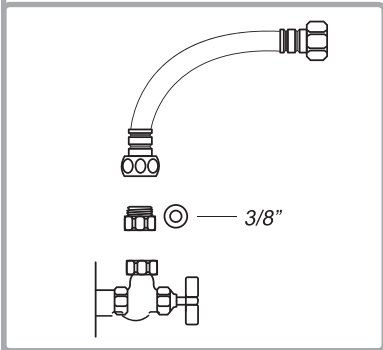

⑤ Open the water valve

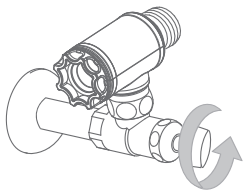

※ The water may overflow out of the rim when cleaning the bowl in the region with high water pressure.

Using a screwdriver, turn the shutoff valve clockwise to reduce the water pressure.

⑥ Connect Power

1. Insert the power plug into the outlet
 2. Press the flush button
- Water will fill the ceramic bowl.

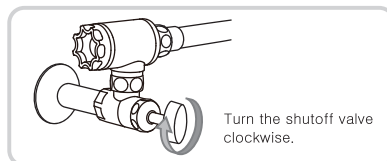
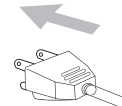

Preparation and Check Before Use

Preparation

1 Place the battery into the remote control

TCB 090SA / TCB 090S
/ RTB 090WA / RTB 090W
/ TCB 8100B / TCB 8100W

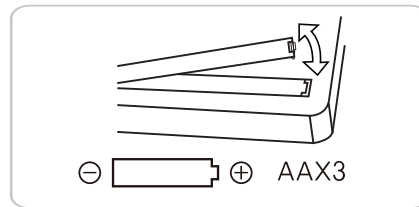
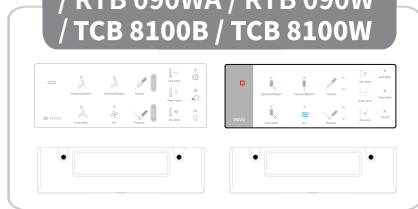

PB-707S / PB-101S

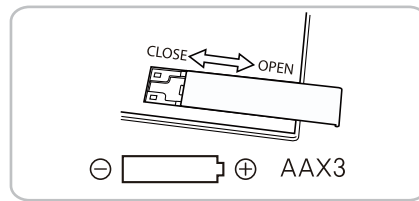
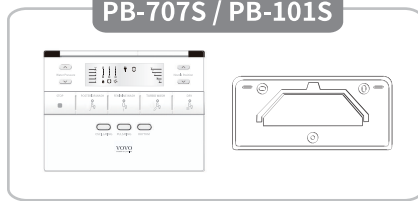

Advice 1

① Hold it on both sides and lift up.

② Open the battery cover on the back.

③ Put 3 AA batteries in order. (Included)

④ Close the cover

PB-707S / PB-101S

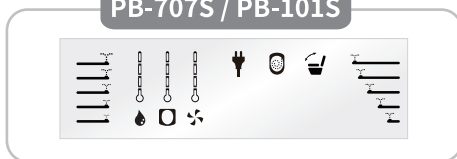

- The indication will display if the batteries are in order (on the left).

About the battery

● Observe the following to prevent breakage or leakage of fluid.

- Use the same type of batteries when to replace old batteries
- Remove batteries when not used for a long time.
- Do not use rechargeable batteries

Sometimes the settings (Temperature, Auto Flush) are initialized after replacing batteries. Configure the settings again.

2 Check if the power plug is connected

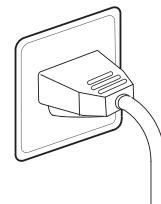

Advice 1 Turn off the power Power on the main body when replacing batteries or cleaning the product.

3 Adjust water flow with the shutoff valve

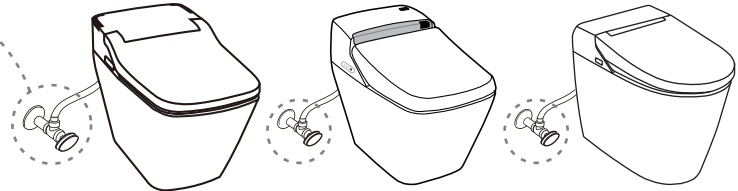
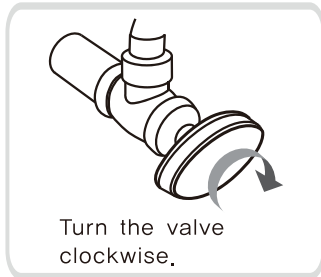

If the water pressure is too high, water may splash or overflow when flushing the toilet. Turn the water shutoff valve clockwise to reduce pressure.

Check

4 Check the display panel

- Is the power indicator LED on?

If not on, press the Power button Power to turn on the device.

After plugging in the power plug, check the power indicator LED is on.

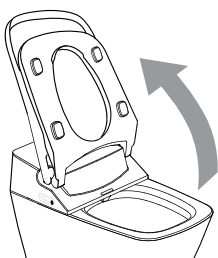
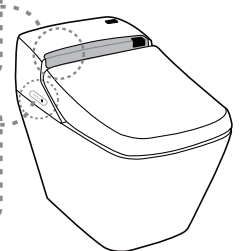
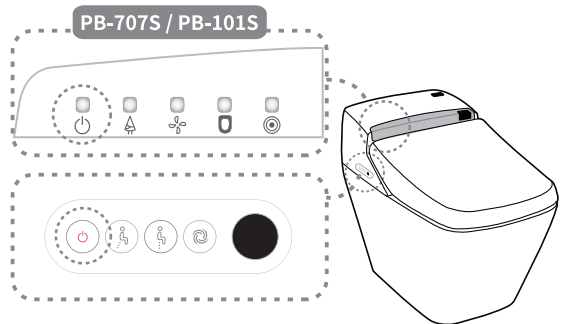
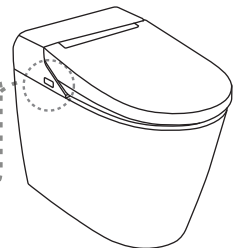
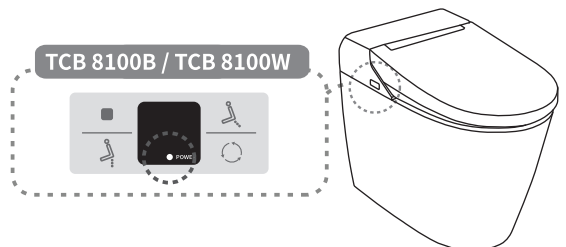
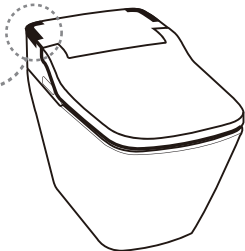

- Please open the seat and the lid when you reset the bidet toilet

Proper Usage

- Preserve the environment with power and water saving mode

- Preserve the environment with power and water saving mode
- Turn on the power saving mode.
 - Adjust Water Temperature and Seat Temperature to a mild level.

TCB 090SA / TCB 090S

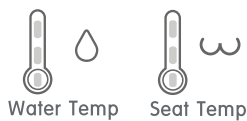

TCB 8100B / TCB 8100W
/ RTB 090WA / RTB 090W

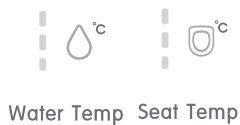

PB-707S / PB-101S



- Turn off the power when not using the product for a long time.
 - Press the 'Power' or 'Stop' button for 3 seconds to turn off the power.

TCB 090SA / TCB 090S
/ RTB 090WA / RTB 090W



PB-707S / PB-101S

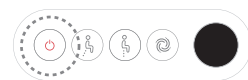

TCB 8100B / TCB 8100W

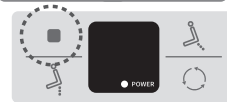

- Close the seat cover.
 - Close the seat cover to save power, and keep the heat on the seat surface stable.



- Do not expose the product to direct sunlight.
 - It can cause the discoloration of product.
 - The heat on the seat surface will become unstable.

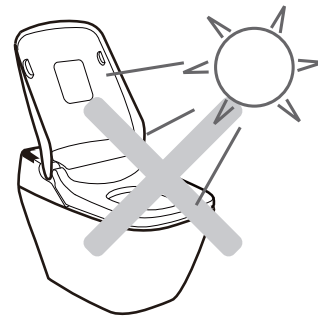

- Drain off the water from the water tank when not using the product for a long time, or when moving the product to another place.
 - It can cause water pollution and the leakage during transportation.

1.

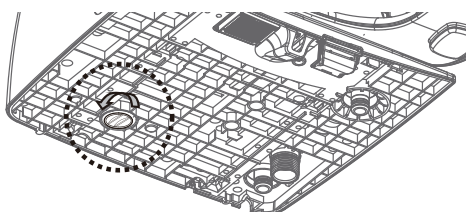

2.

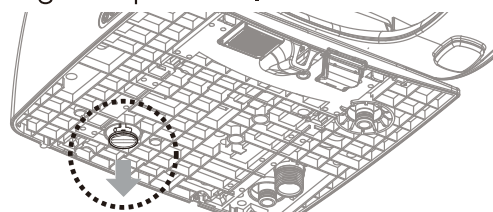



Remote Control

- TCB 090SA

ENGLISH

< TOP >

Flush (Full. Small) Button

- Press the flush button to activate the full or small flush.

Seat Cover Opening/Closing

- Press the seat cover button to automatically open and close the toilet seat cover

Seat Cover and Seat Closing

- Press the close button to close both the toilet seat cover and toilet seat.

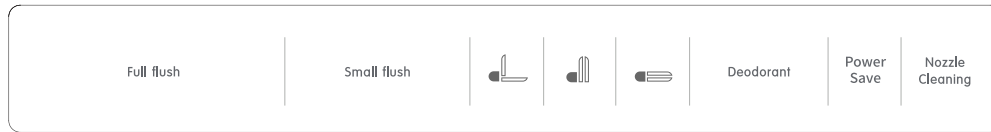

Cover and Seat Opening

- When you press the cover or toilet seat buttons, both the toilet seat cover and the toilet seat are automatically open and closed.

Auto Deodorant ON / OFF

- Press the deodorant button to remove the odor inside the bowl.

Power Save On / OFF

- In power save mode, water temperature, and seat temperature will be adjusted efficiently when not used for more than one hour.
- When the product is used again, the temperature returns back to the original setting.

Nozzle Cleaning

- Press the nozzle cleaning button to clean the nozzle in a moving forward position.

< Front >

Stop

- To stop the function being used, press the STOP button.

Posterior/Rhythm

- Performs Posterior wash(Back area of the body) by pushing the button once.
- Performs Rhythm function when pushed the button again while the posterior function is on the process.
- During Rhythm function, the nozzle will move to wash wide area and provide pulsating massage effect with changing water pressure.

Feminine/Rhythm

- Performs Feminine wash(Frontal area of the body) by pushing the button once.
- Performs Rhythm function when pushed the button again while the feminine function is on the process.
- During Rhythm function, the nozzle will move to wash wide area and provide pulsating massage effect with changing water pressure.

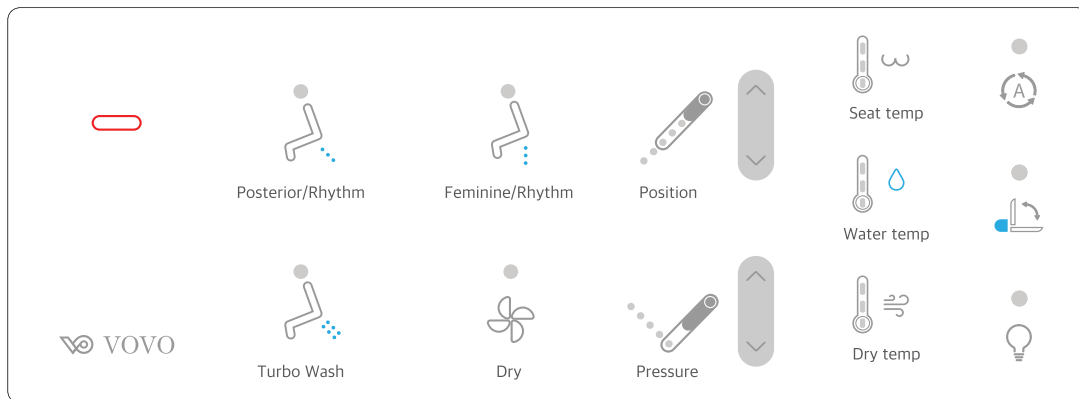

Position

- The nozzle position can be adjusted in five steps.

Turbo Wash

- Press the Turbo Wash button to activate washing water spray from the nozzle.

Pressure

- It is possible to adjust the water pressure of Posterior wash, Feminine wash, and Turbo wash in five steps.

Auto Lid Open / Close

- When you stand in front of the toilet, the lid automatically opens, and when you move away from the toilet, the lid automatically closes.

Seat Temp

- The toilet seat temperature button can adjust the temperature of the toilet seat in three steps.

Dry

- Dry off the water after using the posterior Wash, Feminine Wash, and Turbo Wash function.
- It takes time to dry completely.

Water Temp

- It is possible to adjust the water temperature of Posterior wash, Feminine wash, and Turbo wash in three steps.

UV LED Light ON / OFF (Option)

- UV LED eliminates germs and bacterias as well as sterilizing the bowl.
- When UV LED function is activated, UV LED will turn on and it will automatically turn off while seated.

Auto Flush ON/OFF

- The seat sensor detects user's seating and flushes automatically by differentiating large and small flushes based on user's seated time. (Less than 2mins, small flush / more than 2 mins, large flush)

Dry Temp

- The temperature of the drying function can be adjusted in three steps.

Télécommande

- TCB 090SA

FRENCH

< DESSUS >

Bouton (petite/grande) chasse d'eau

- Appuyez sur le bouton de la chasse d'eau afin d'actionner la petite ou la grande chasse.

Ouverture/Fermeture du couvercle des toilettes

- Appuyez sur le bouton « DESSUS » afin d'ouvrir et de fermer automatiquement le couvercle des toilettes.

Fermeture du couvercle et du siège des toilettes

- Appuyez sur le bouton « Fermeture » afin de fermer à la fois le couvercle et le siège des toilettes.

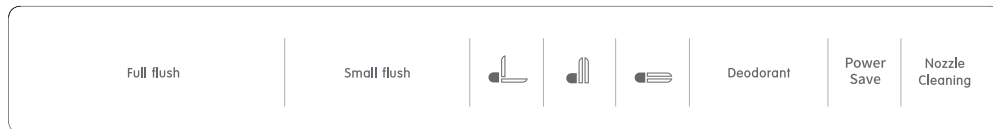

Ouverture du couvercle et du siège des toilettes

- Lorsque vous appuyez sur les boutons du couvercle ou du siège des toilettes, le couvercle et le siège s'ouvrent et se ferment automatiquement.

Désodorisation automatique marche/arrêt

- Appuyez sur le bouton « Désodorisation » afin d'éliminer les odeurs émanant de l'intérieur de la cuvette.

Mode d'économie d'énergie marche/arrêt

- Vous pouvez activer ou désactiver le mode d'économie d'énergie. Appuyez et maintenez le bouton d'alimentation sur le côté pendant 3 secondes afin d'éteindre le bidet, puis activez ou désactivez le mode d'économie d'énergie en appuyant sur le bouton « Zone intime de la femme ». Cela vous permettra d'économiser le temps inutilisé et les coûts d'électricité.

Nettoyage de la buse

- Appuyez sur le bouton « Nettoyage de la buse » afin de nettoyer la buse en position avancée.

< DEVANT >

Stop

- Afin de stopper le fonctionnement en cours, appuyez sur le bouton « Stop ».

Postérieur/Nettoyage à impulsions

- Appuyez une fois sur le bouton afin d'effectuer le nettoyage du postérieur (zone arrière du corps).
- Pour effectuer le nettoyage à impulsions, appuyez de nouveau sur le bouton pendant que le nettoyage du postérieur est en cours.
- Durant le nettoyage à impulsions, la buse se déplace afin de nettoyer largement la zone et offre un effet de massage à impulsions en changeant la pression de l'eau.

Nettoyage de la zone intime de la femme

- Zone intime de la femme/Nettoyage à impulsions
- Appuyez une fois sur le bouton afin d'effectuer le nettoyage de la zone intime de la femme (zone frontale du corps).
- Pour effectuer le nettoyage à impulsions, appuyez de nouveau sur le bouton pendant que le nettoyage de la zone intime est en cours.
- Durant le nettoyage à impulsions, la buse se déplace afin de nettoyer largement la zone et offre un effet de massage à impulsions en changeant la pression de l'eau.

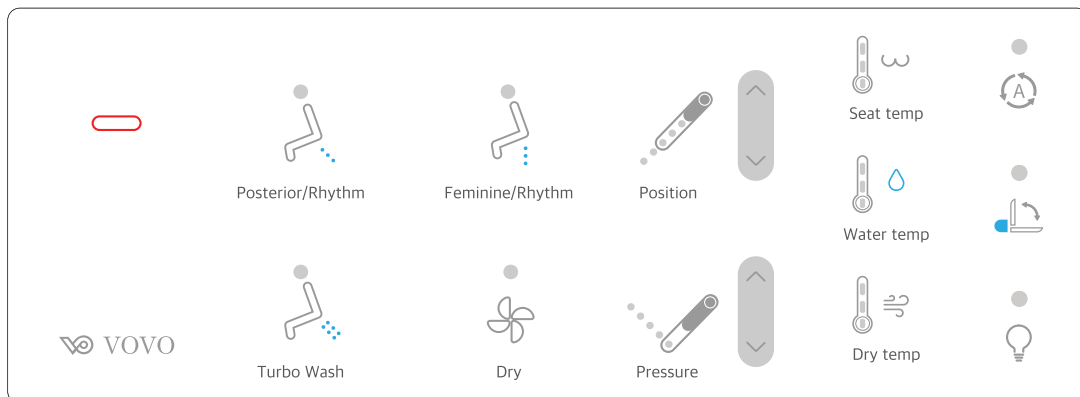

Position

- La position de la buse est réglable sur 5 niveaux.

Nettoyage turbo

- Appuyez sur le bouton « Nettoyage turbo » afin d'activer le jet d'eau permettant de vous laver à partir de la buse.

Température de l'eau

- Il est possible de régler la température de l'eau sur 3 niveaux pour le nettoyage du postérieur et de la zone intime de la femme, ainsi que pour le lavement.

Ouverture/Fermeture automatique du couvercle

-Le couvercle s'ouvre automatiquement lorsque vous vous tenez debout devant les toilettes. Et il se ferme automatiquement lorsque vous vous éloignez des toilettes.

Température du siège

- Le bouton « Température du siège » vous permet de régler la température du siège sur 3 niveaux.

Séchage

- Sèche l'eau après avoir utilisé les fonctions du nettoyage du postérieur, de la zone intime de la femme et du nettoyage turbo.
- Il faut du temps pour sécher complètement.

Température de séchage

- La température de séchage est réglable sur 3 niveaux.

Chasse d'eau automatique marche/arrêt

- Cette fonction distingue l'urine des matières fécales.

Pression

- Il est possible de régler la pression de l'eau sur 5 niveaux pour le nettoyage du postérieur, de la zone intime de la femme et du nettoyage turbo.

Lumière LED UV marche/arrêt (Option)

- La LED UV tue les germes et les bactéries et stérilise le bol.
- Lorsque les fonctions de la lumière LED d'UV est activée, celle-ci va être allumée et s'éteint automatiquement lorsqu'on s'assoit.



Mando a distancia

- TCB 090SA

SPANISH

<Parte superior>

Botón de descarga (completa - pequeña)

-Presione el botón de descarga para activar la descarga completa o pequeña.

Apertura/Cierre de la tapa del asiento

-Presione el botón de la tapa del asiento del retrete para abrirla o cerrarla de manera automática.

Cierre de la tapa y del asiento

-Presione el botón de cierre para cerrar tanto la tapa del asiento como el asiento del retrete.

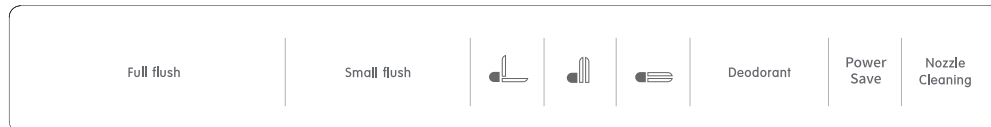

Apertura de la tapa y del asiento

-Al presionar el botón de la tapa del asiento o del asiento del retrete, ambos se abren o se cierran de manera automática.

Encendido/Apagado de la desodorización automática

-Presione el botón de desodorización para eliminar el olor del interior de la taza.

Encendido/Apagado del ahorro de energía

-En el modo de ahorro de energía, la temperatura del agua y del asiento se ajustarán de manera eficiente cuando no se haya utilizado por más de una hora.
-Cuando se use de nuevo el producto, la temperatura volverá a la configuración original.

Limpieza de la boquilla

-Presione el botón de limpieza de la boquilla para limpiarla hacia el frente.

<Parte frontal>

Detener

-Para detener la función que se está utilizando, presione el botón DETENER.

Posterior/Ritmo

-Realiza el lavado posterior (zona posterior del cuerpo) cuando se presiona el botón una vez.
-Realiza la función Ritmo cuando se presiona de nuevo el botón mientras la función posterior está activa.
-Durante la función Ritmo, la boquilla se moverá para lavar una zona amplia y generar un efecto de masaje pulsante con cambios en la presión del agua.

Femenino/Ritmo

-Realiza el lavado femenino (zona frontal del cuerpo) cuando se presiona el botón una vez.
-Realiza la función Ritmo cuando se presiona de nuevo el botón mientras la función femenino está activa.
-Durante la función Ritmo, la boquilla se moverá para lavar una zona amplia y generar un efecto de masaje pulsante con cambios en la presión del agua.

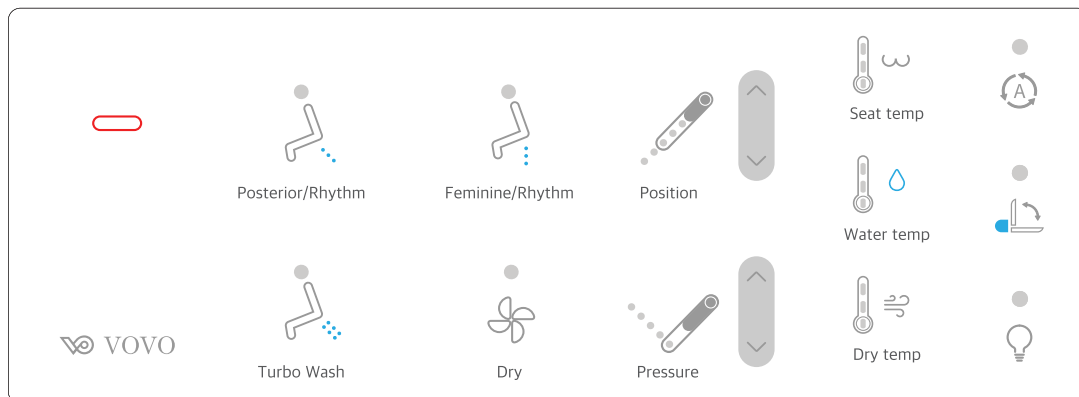

Posición

-La posición de la boquilla puede ser ajustada en cinco niveles.

Temperatura del asiento

-El botón de temperatura del asiento del retrete puede ajustar su temperatura en tres niveles.

Encendido/Apagado de la descarga automática

-El sensor del asiento detecta al usuario y descarga de manera automática diferenciando entre descargas grandes y pequeñas. Esto en función del tiempo que el usuario permanezca sentado.

Lavado turbo

-Presione el botón de lavado turbo para activar el chorro de agua de lavado desde la boquilla.

Secado

-Seca el agua después de utilizar las funciones de lavado posterior, lavado femenino y lavado turbo.

Temperatura de secado

-La temperatura de la función de secado puede ser ajustada en tres niveles.

Presión

-Es posible ajustar la presión del agua del lavado posterior, lavado femenino y lavado turbo en cinco niveles.

Temperatura del agua

-Es posible ajustar la temperatura del agua del lavado posterior, lavado femenino y lavado turbo en cinco niveles.

Opción de encendido/apagado de la luz LED UV

-La luz LED UV elimina gérmenes y bacterias a la vez que esteriliza la taza.
-Cuando la función LED UV esté activada, el LED UV se encenderá, y se apagará de manera automática mientras esté sentado.

Apertura/Cierre automático de la tapa

-Cuando se ubique delante del retrete o se aleje de este, la tapa se abrirá o cerrará respectivamente de manera automática.

Temperatura del asiento

-El botón de temperatura del asiento del retrete puede ajustar su temperatura en tres niveles.

Remote Control

- TCB 090S

ENGLISH

< TOP >

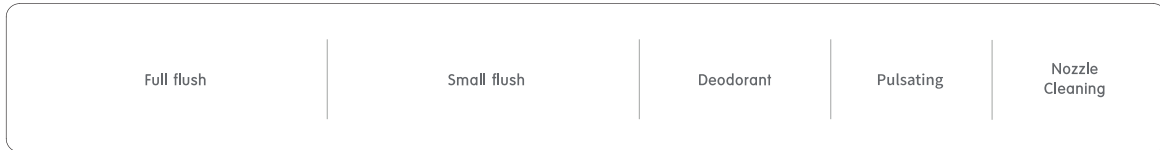

Flush (Full. Small) Button

- Press the flush button to activate the full or small flush.

Pulsating

- Press the pulsating button to repeat the intensity of the water pressure from strong to weak.

Auto Deodorant ON / OFF

- Press the deodorant button to remove the odor inside the bowl.

Nozzle Cleaning

- Press the nozzle cleaning button to clean the nozzle in a moving forward position.

< Front >

Stop

- To stop the function being used, press the STOP button.

Posterior/Rhythm

- Performs Posterior wash (Back area of the body) by pushing the button once.
 - Performs Rhythm function when pushed the button again while the posterior function is on the process.
 - During Rhythm function, the nozzle will move to wash wide area and provide pulsating massage effect with changing water pressure.

Feminine/Rhythm

- Performs Feminine wash (Frontal area of the body) by pushing the button once.
 - Performs Rhythm function when pushed the button again while the feminine function is on the process.
 - During Rhythm function, the nozzle will move to wash wide area and provide pulsating massage effect with changing water pressure.

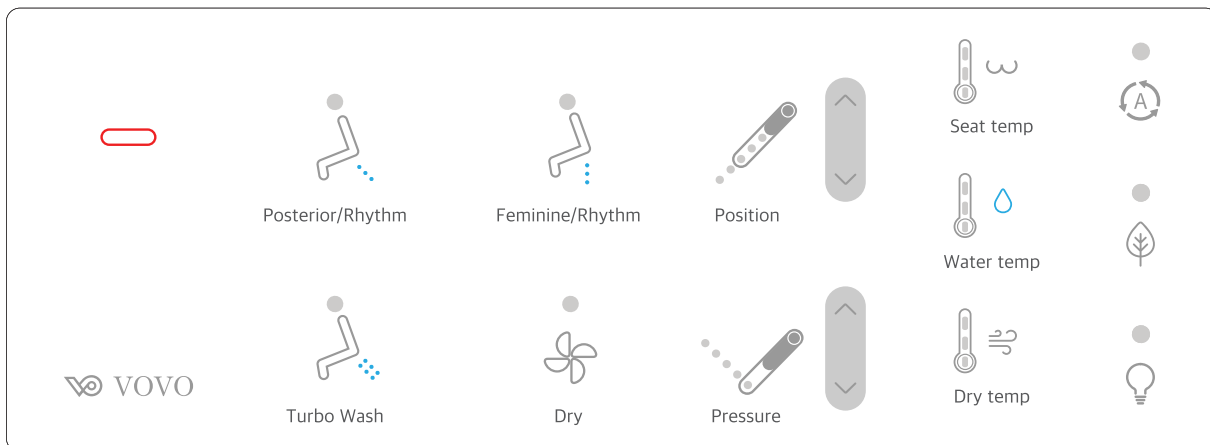

Position

- The nozzle position can be adjusted in five steps.

Turbo Wash

- Press the Turbo Wash button to activate washing water spray from the nozzle.

Pressure

- It is possible to adjust the water pressure of Posterior wash, Feminine wash, and Turbo wash in five steps.

Power Save On / OFF

- In power save mode, water temperature and seat temperature will be adjusted efficiently when not used for more than one hour.
 - When the product is used again, the temperature returns back to the original setting.

Seat Temp

- The toilet seat temperature button can adjust the temperature of the toilet seat in three steps.

Dry

- Dry off the water after using the posterior Wash, Feminine Wash, and Turbo Wash function.
 - It takes time to dry completely.

Water Temp

- It is possible to adjust the water temperature of Posterior wash, Feminine wash, and Turbo wash in three steps.

UV LED Light ON / OFF (Option)

- UV LED eliminates germs and bacteria as well as sterilizing the bowl.
 - When UV LED function is activated, UV LED will turn on and it will automatically turn off while seated.

Auto Flush ON/OFF

- The seat sensor detects user's seating and flushes automatically by differentiating large and small flushes based on user's seated time. (Less than 2mins, small flush / more than 2 mins, large flush)

Dry Temp

- The temperature of the drying function can be adjusted in three steps.

Télécommande

- TCB 090S

FRENCH

< DESSUS >

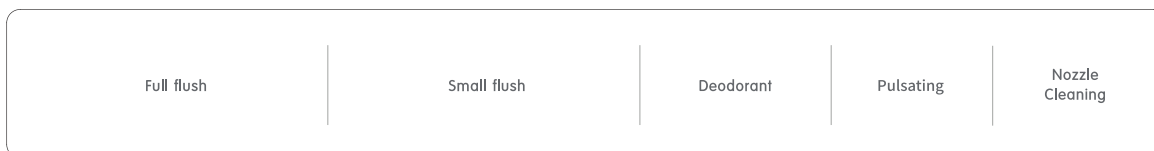

Bouton (petite/grande) chasse d'eau

Appuyez sur le bouton de la chasse d'eau afin d'actionner la petite ou la grande chasse.

Impulsion

Appuyez sur le bouton « Impulsion » afin que la pression de l'eau varie en continue de l'intensité faible à forte.

Désodorisation automatique marche/arrêt

- Appuyez sur le bouton « Désodorisation » afin d'éliminer les odeurs émanant de l'intérieur de la cuvette.

Nettoyage de la buse

- Appuyez sur le bouton « Nettoyage de la buse » afin de nettoyer la buse en position avancée.

< DEVANT >

Stop

- Afin de stopper le fonctionnement en cours, appuyez sur le bouton « Stop ».

Postérieur/Nettoyage à impulsions

- Appuyez une fois sur le bouton afin d'effectuer le nettoyage du postérieur (zone arrière du corps).
- Pour effectuer le nettoyage à impulsions, appuyez de nouveau sur le bouton pendant que le nettoyage du postérieur est en cours.
- Durant le nettoyage à impulsions, la buse se déplace afin de nettoyer largement la zone et offre un effet de massage à impulsions en changeant la pression de l'eau.

Nettoyage de la zone intime de la femme

- Zone intime de la femme/Nettoyage à impulsions
- Appuyez une fois sur le bouton afin d'effectuer le nettoyage de la zone intime de la femme (zone frontale du corps).
- Pour effectuer le nettoyage à impulsions, appuyez de nouveau sur le bouton pendant que le nettoyage de la zone intime est en cours.
- Durant le nettoyage à impulsions, la buse se déplace afin de nettoyer largement la zone et offre un effet de massage à impulsions en changeant la pression de l'eau.

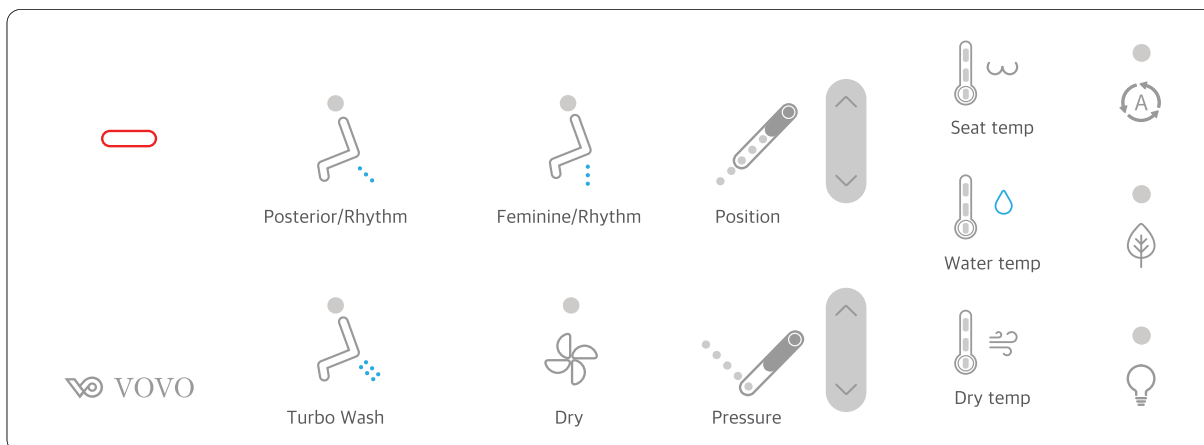

Position

- La position de la buse est réglable sur 5 niveaux.

Température du siège

- Le bouton « Température du siège » vous permet de régler la température du siège sur 3 niveaux.

Chasse d'eau automatique marche/arrêt

- Cette fonction distingue l'urine des matières fécales.

Nettoyage turbo

- Appuyez sur le bouton « Nettoyage turbo » afin d'activer le jet d'eau permettant de vous laver à partir de la buse.

Séchage

- Séchez l'eau après avoir utilisé les fonctions du nettoyage du postérieur, de la zone intime de la femme et du nettoyage turbo.
- Il faut du temps pour sécher complètement.

Pression

- Il est possible de régler la pression de l'eau sur 5 niveaux pour le nettoyage du postérieur, de la zone intime de la femme et du nettoyage turbo.

Température de l'eau

- Il est possible de régler la température de l'eau sur 3 niveaux pour le nettoyage du postérieur et de la zone intime de la femme, ainsi que pour le lavement.

Température de séchage

- La température de séchage est réglable sur 3 niveaux.

Mode d'économie d'énergie

- En mode d'économie d'énergie, la température de l'eau et celle du siège se réglent de manière efficace lorsqu'elles ne sont pas utilisées pendant plus d'1h.
- Lorsque les toilettes sont utilisées de nouveau, la température revient au réglage initial.

Lumière LED UV marche/arrêt (Option)

- La LED UV tue les germes et les bactéries et stérilise le bol.
- Lorsque les fonctions de la lumière LED d'UV est activée, celle-ci va être allumée et s'éteint automatiquement lorsqu'on s'assoit.



Mando a distancia

- TCB 090S

SPANISH

<Parte superior>

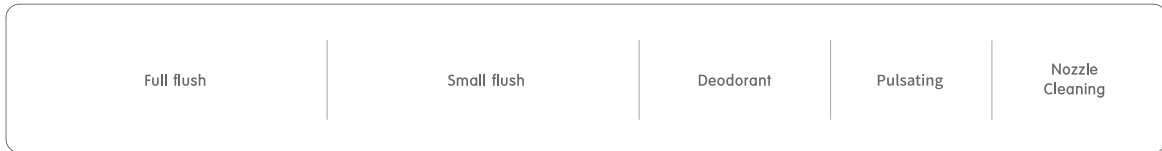

Botón de descarga (completa - pequeña)

-Presione el botón de descarga para activar la descarga completa o pequeña.

Encendido/Apagado de la desodorización automática

-Presione el botón de desodorización para eliminar el olor del interior de la taza.

Pulsante

-presione el botón pulsante para repetir la intensidad de la presión del agua de fuerte a débil.

Limpieza de la boquilla

-Presione el botón de limpieza de la boquilla para limpiarla hacia el frente.

<Parte frontal>

Detener

-Para detener la función que se está utilizando, presione el botón DETENER.

Posterior/Ritmo

-Realiza el lavado posterior (zona posterior del cuerpo) cuando se presiona el botón una vez.
-Realiza la función Ritmo cuando se presiona de nuevo el botón mientras la función posterior está activa.
-Durante la función Ritmo, la boquilla se moverá para lavar una zona amplia y generar un efecto de masaje pulsante con cambios en la presión del agua.

Femenino/Ritmo

-Realiza el lavado femenino (zona frontal del cuerpo) cuando se presiona el botón una vez.
-Realiza la función Ritmo cuando se presiona de nuevo el botón mientras la función femenino está activa.
-Durante la función Ritmo, la boquilla se moverá para lavar una zona amplia y generar un efecto de masaje pulsante con cambios en la presión del agua.

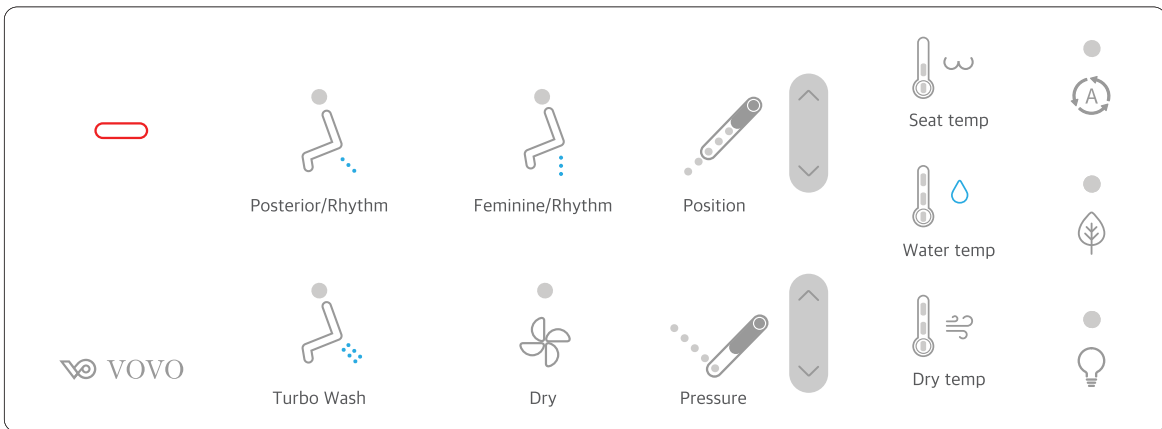

Posición

-La posición de la boquilla puede ser ajustada en cinco niveles.

Temperatura del asiento

-El botón de temperatura del asiento del retrete puede ajustar su temperatura en tres niveles.

Encendido/Apagado de la descarga automática

-El sensor del asiento detecta al usuario y descarga de manera automática diferenciando entre descargas grandes y pequeñas. Esto en función del tiempo que el usuario permanezca sentado.

Lavado turbo

-Presione el botón de lavado turbo para activar el chorro de agua de lavado desde la boquilla.

Secado

-Seca el agua después de utilizar las funciones de lavado posterior, lavado femenino y lavado turbo.

Encendido/Apagado del ahorro de energía

-En el modo de ahorro de energía, la temperatura del agua y del asiento se ajustarán de manera eficiente cuando no se haya utilizado por más de una hora.
-Cuando se use de nuevo el producto, la temperatura volverá a la configuración original.

Presión

-Es posible ajustar la presión del agua del lavado posterior, lavado femenino y lavado turbo en cinco niveles.

Temperatura del agua

-Es posible ajustar la temperatura del agua del lavado posterior, lavado femenino y lavado turbo en cinco niveles.

Apertura/Cierre automático de la tapa

-Cuando se ubique delante del retrete o se aleje de este, la tapa se abrirá o cerrará respectivamente de manera automática.

Temperatura del asiento

-El botón de temperatura del asiento del retrete puede ajustar su temperatura en tres niveles.

Opción de encendido/apagado de la luz LED UV

-La luz LED UV elimina gérmenes y bacterias a la vez que esteriliza la taza.
-Cuando la función LED UV esté activada, el LED UV se encenderá, y se apagará de manera automática mientras esté sentado.



Remote Control

ENGLISH

- RTB 090WA

< TOP >

Flush (Full. Small) Button

- Press the flush button to activate the full or small flush.

Seat Cover Opening/Closing

- Press the seat cover button to automatically open and close the toilet seat cover

Seat Cover and Seat Closing

- Press the close button to close both the toilet seat cover and toilet seat.

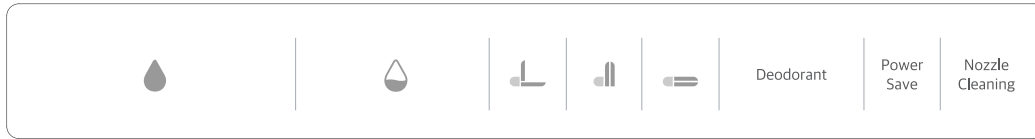

Cover and Seat Opening

- When you press the cover or toilet seat buttons, both the toilet seat cover and the toilet seat are automatically open and closed.

Auto Deodorant ON / OFF

- Press the deodorant button to remove the odor inside the bowl.

Power Save On / OFF

- In power save mode, water temperature, and seat temperature will be adjusted efficiently when not used for more than one hour.
- When the product is used again, the temperature returns back to the original setting.

Nozzle Cleaning

- Press the nozzle cleaning button to clean the nozzle in a moving forward position.

< Front >

Stop

- To stop the function being used, press the STOP button.

Posterior/Rhythm

- Performs Posterior wash(Back area of the body) by pushing the button once.
- Performs Rhythm function when pushed the button again while the posterior function is on the process.
- During Rhythm function, the nozzle will move to wash wide area and provide pulsating massage effect with changing water pressure.

Feminine/Rhythm

- Performs Feminine wash(Frontal area of the body) by pushing the button once.
- Performs Rhythm function when pushed the button again while the feminine function is on the process.
- During Rhythm function, the nozzle will move to wash wide area and provide pulsating massage effect with changing water pressure.

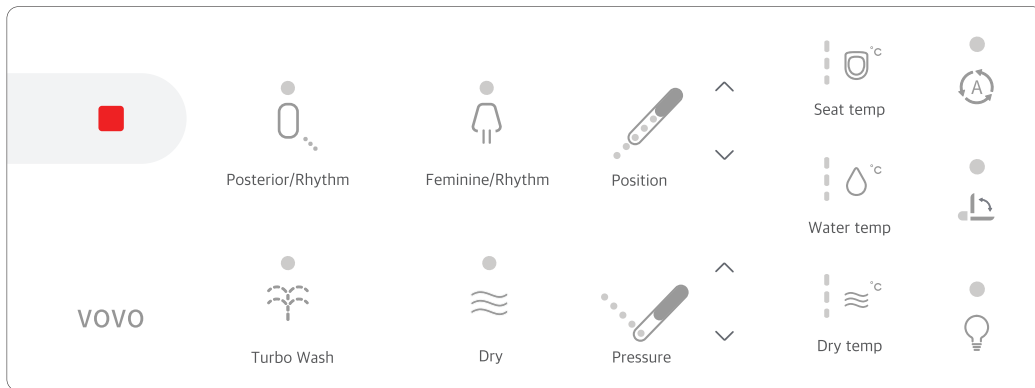

Position

- The nozzle position can be adjusted in five steps.

Seat Temp

- The toilet seat temperature button can adjust the temperature of the toilet seat in three steps.

Auto Flush ON/OFF

- The seat sensor detects user's seating and flushes automatically by differentiating large and small flushes based on user's seated time. (Less than 2mins, small flush / more than 2 mins, large flush)

Turbo Wash

- Press the Turbo Wash button to activate washing water spray from the nozzle.

Dry

- Dry off the water after using the posterior Wash, Feminine Wash, and Turbo Wash function.
- It takes time to dry completely.

Dry Temp

- The temperature of the drying function can be adjusted in three steps.

Pressure

- It is possible to adjust the water pressure of Posterior wash, Feminine wash, and Turbo wash in five steps.

Water Temp

- It is possible to adjust the water temperature of Posterior wash, Feminine wash, and Turbo wash in three steps.

Auto Lid Open / Close

- When you stand in front of the toilet, the lid automatically opens, and when you move away from the toilet, the lid automatically closes.

UV LED Light ON / OFF (Option)

- UV LED eliminates germs and bacterias as well as sterilizing the bowl.
- When UV LED function is activated, UV LED will turn on and it will automatically turn off while seated.

Télécommande

- RTB 090WA

FRENCH

< DESSUS >

Bouton (petite/grande) chasse d'eau

- Appuyez sur le bouton de la chasse d'eau afin d'actionner la petite ou la grande chasse.

Ouverture/Fermeture du couvercle des toilettes

- Appuyez sur le bouton « DESSUS » afin d'ouvrir et de fermer automatiquement le couvercle des toilettes.

Fermeture du couvercle et du siège des toilettes

- Appuyez sur le bouton « Fermeture » afin de fermer à la fois le couvercle et le siège des toilettes.

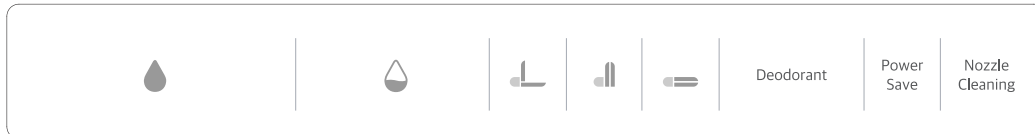

Ouverture du couvercle et du siège des toilettes

- Lorsque vous appuyez sur les boutons du couvercle ou du siège des toilettes, le couvercle et le siège s'ouvrent et se ferment automatiquement.

Désodorisation automatique marche/arrêt

- Appuyez sur le bouton « Désodorisation » afin d'éliminer les odeurs émanant de l'intérieur de la cuvette.

Mode d'économie d'énergie marche/arrêt

- Vous pouvez activer ou désactiver le mode d'économie d'énergie. Appuyez et maintenez le bouton d'alimentation sur le côté pendant 3 secondes afin d'éteindre le bidet, puis activez ou désactivez le mode d'économie d'énergie en appuyant sur le bouton « Zone intime de la femme ». Cela vous permettra d'économiser le temps inutilisé et les coûts d'électricité.

Nettoyage de la buse

- Appuyez sur le bouton « Nettoyage de la buse » afin de nettoyer la buse en position avancée.

< DEVANT >

Stop

- Afin de stopper le fonctionnement en cours, appuyez sur le bouton « Stop ».

Postérieur/Nettoyage à impulsions

- Appuyez une fois sur le bouton afin d'effectuer le nettoyage du postérieur (zone arrière du corps).
- Pour effectuer le nettoyage à impulsions, appuyez de nouveau sur le bouton pendant que le nettoyage du postérieur est en cours.
- Durant le nettoyage à impulsions, la buse se déplace afin de nettoyer largement la zone et offre un effet de massage à impulsions en changeant la pression de l'eau.

Nettoyage de la zone intime de la femme

- Zone intime de la femme/Nettoyage à impulsions
- Appuyez une fois sur le bouton afin d'effectuer le nettoyage de la zone intime de la femme (zone frontale du corps).
- Pour effectuer le nettoyage à impulsions, appuyez de nouveau sur le bouton pendant que le nettoyage de la zone intime est en cours.
- Durant le nettoyage à impulsions, la buse se déplace afin de nettoyer largement la zone et offre un effet de massage à impulsions en changeant la pression de l'eau.

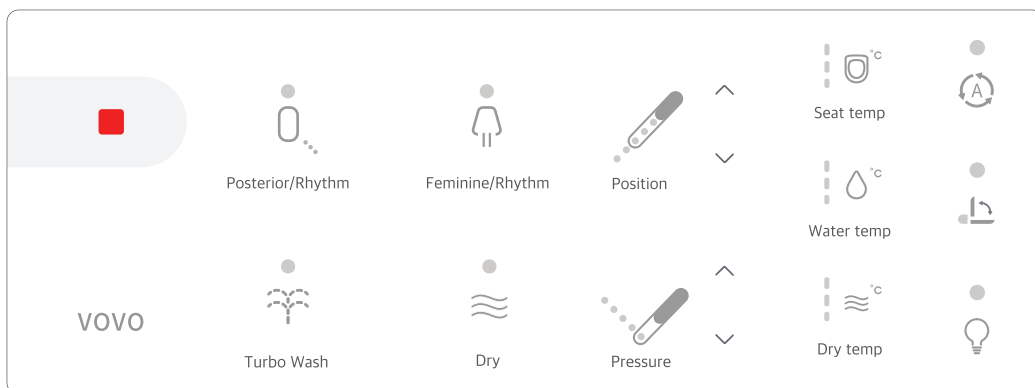

Position

- La position de la buse est réglable sur 5 niveaux.

Nettoyage turbo

- Appuyez sur le bouton « Nettoyage turbo » afin d'activer le jet d'eau permettant de vous laver à partir de la buse.

Température de l'eau

- Il est possible de régler la température de l'eau sur 3 niveaux pour le nettoyage du postérieur et de la zone intime de la femme, ainsi que pour le lavement.

Ouverture/Fermeture automatique du couvercle

-Le couvercle s'ouvre automatiquement lorsque vous vous tenez debout devant les toilettes. Et il se ferme automatiquement lorsque vous vous éloignez des toilettes.

Température du siège

- Le bouton « Température du siège » vous permet de régler la température du siège sur 3 niveaux.

Séchage

- Sèche l'eau après avoir utilisé les fonctions du nettoyage du postérieur, de la zone intime de la femme et du nettoyage turbo.
- Il faut du temps pour sécher complètement.

Température de séchage

- La température de séchage est réglable sur 3 niveaux.

Chasse d'eau automatique marche/arrêt

- Cette fonction distingue l'urine des matières fécales.

Pression

- Il est possible de régler la pression de l'eau sur 5 niveaux pour le nettoyage du postérieur, de la zone intime de la femme et du nettoyage turbo.

Lumière LED UV marche/arrêt (Option)

- La LED UV tue les germes et les bactéries et stérilise le bol.
- Lorsque les fonctions de la lumière LED d'UV est activée, celle-ci va être allumée et s'éteint automatiquement lorsqu'on s'assoit.



Mando a distancia

SPANISH

- RTB 090WA

<Parte superior>

Botón de descarga (completa - pequeña)

-Presione el botón de descarga para activar la descarga completa o pequeña.

Apertura/Cierre de la tapa del asiento

-Presione el botón de la tapa del asiento del retrete para abrirla o cerrarla de manera automática.

Cierre de la tapa y del asiento

-Presione el botón de cierre para cerrar tanto la tapa del asiento como el asiento del retrete.

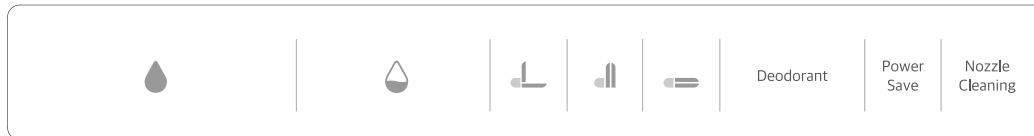

Apertura de la tapa y del asiento

-Al presionar el botón de la tapa del asiento o del asiento del retrete, ambos se abren o se cierran de manera automática.

Encendido/Apagado de la desodorización automática

-Presione el botón de desodorización para eliminar el olor del interior de la taza.

Encendido/Apagado del ahorro de energía

-En el modo de ahorro de energía, la temperatura del agua y del asiento se ajustarán de manera eficiente cuando no se haya utilizado por más de una hora.
-Cuando se use de nuevo el producto, la temperatura volverá a la configuración original.

Limpieza de la boquilla

-Presione el botón de limpieza de la boquilla para limpiarla hacia el frente.

<Parte frontal>

Detener

-Para detener la función que se está utilizando, presione el botón DETENER.

Posterior/Ritmo

-Realiza el lavado posterior (zona posterior del cuerpo) cuando se presiona el botón una vez.
-Realiza la función Ritmo cuando se presiona de nuevo el botón mientras la función posterior está activa.
-Durante la función Ritmo, la boquilla se moverá para lavar una zona amplia y generar un efecto de masaje pulsante con cambios en la presión del agua.

Femenino/Ritmo

-Realiza el lavado femenino (zona frontal del cuerpo) cuando se presiona el botón una vez.
-Realiza la función Ritmo cuando se presiona de nuevo el botón mientras la función femenino está activa.
-Durante la función Ritmo, la boquilla se moverá para lavar una zona amplia y generar un efecto de masaje pulsante con cambios en la presión del agua.

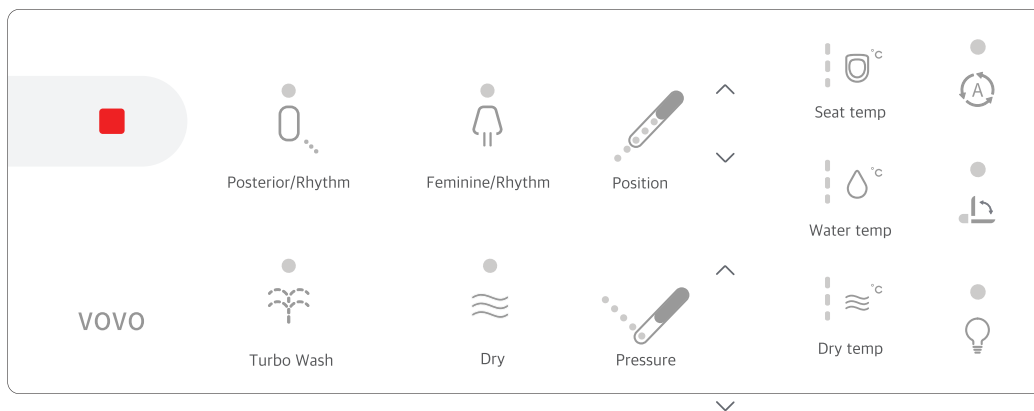

Posición

-La posición de la boquilla puede ser ajustada en cinco niveles.

Temperatura del asiento

-El botón de temperatura del asiento del retrete puede ajustar su temperatura en tres niveles.

Encendido/Apagado de la descarga automática

-El sensor del asiento detecta al usuario y descarga de manera automática diferenciando entre descargas grandes y pequeñas. Esto en función del tiempo que el usuario permanezca sentado.

Lavado turbo

-Presione el botón de lavado turbo para activar el chorro de agua de lavado desde la boquilla.

Secado

-Seca el agua después de utilizar las funciones de lavado posterior, lavado femenino y lavado turbo.

Temperatura de secado

-La temperatura de la función de secado puede ser ajustada en tres niveles.

Presión

-Es posible ajustar la presión del agua del lavado posterior, lavado femenino y lavado turbo en cinco niveles.

Temperatura del agua

-Es posible ajustar la temperatura del agua del lavado posterior, lavado femenino y lavado turbo en cinco niveles.

Opción de encendido/apagado de la luz LED UV

-La luz LED UV elimina gérmenes y bacterias a la vez que esteriliza la taza.
-Cuando la función LED UV esté activada, el LED UV se encenderá, y se apagará de manera automática mientras esté sentado.

Apertura/Cierre automático de la tapa

-Cuando se ubique delante del retrete o se aleje de este, la tapa se abrirá o cerrará respectivamente de manera automática.

Temperatura del asiento

-El botón de temperatura del asiento del retrete puede ajustar su temperatura en tres niveles.

Remote Control

ENGLISH

- RTB 090W

< TOP >

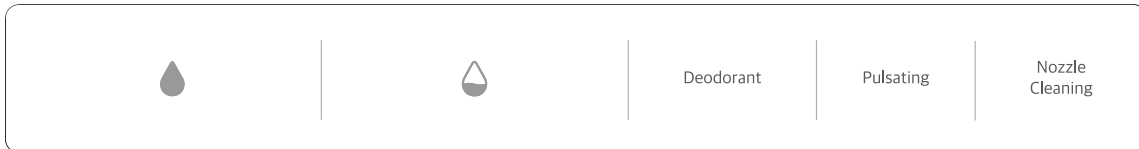

Flush (Full, Small) Button

- Press the flush button to activate the full or small flush.

Auto Deodorant ON / OFF

- Press the deodorant button to remove the odor inside the bowl.

Pulsating

- Press the pulsating button to repeat the intensity of the water pressure from strong to weak.

Nozzle Cleaning

- Press the nozzle cleaning button to clean the nozzle in a moving forward position.

< Front >

Stop

- To stop the function being used, press the STOP button.

Posterior/Rhythm

- Performs Posterior wash (Back area of the body) by pushing the button once.
- Performs Rhythm function when pushed the button again while the posterior function is on the process.
- During Rhythm function, the nozzle will move to wash wide area and provide pulsating massage effect with changing water pressure.

Feminine/Rhythm

- Performs Feminine wash (Frontal area of the body) by pushing the button once.
- Performs Rhythm function when pushed the button again while the feminine function is on the process.
- During Rhythm function, the nozzle will move to wash wide area and provide pulsating massage effect with changing water pressure.

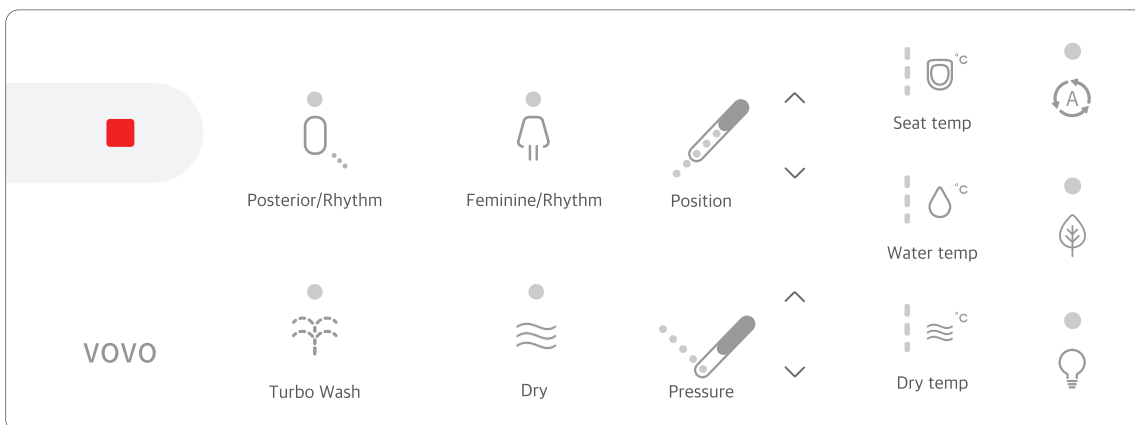

Position

- The nozzle position can be adjusted in five steps.

Turbo Wash

- Press the Turbo Wash button to activate washing water spray from the nozzle.

Pressure

- It is possible to adjust the water pressure of Posterior wash, Feminine wash, and Turbo wash in five steps.

Power Save On / OFF

- In power save mode, water temperature and seat temperature will be adjusted efficiently when not used for more than one hour.
- When the product is used again, the temperature returns back to the original setting.

Seat Temp

- The toilet seat temperature button can adjust the temperature of the toilet seat in three steps.

Dry

- Dry off the water after using the posterior Wash, Feminine Wash, and Turbo Wash function.
- It takes time to dry completely.

Water Temp

- It is possible to adjust the water temperature of Posterior wash, Feminine wash, and Turbo wash in three steps.

UV LED Light ON / OFF (Option)

- UV LED eliminates germs and bacteria as well as sterilizing the bowl.
- When UV LED function is activated, UV LED will turn on and it will automatically turn off while seated.

Auto Flush ON/OFF

- The seat sensor detects user's seating and flushes automatically by differentiating large and small flushes based on user's seated time. (Less than 2mins, small flush / more than 2 mins, large flush)

Dry Temp

- The temperature of the drying function can be adjusted in three steps.

Télécommande

FRENCH

- RTB 090W

< DESSUS >



Bouton (petite/grande) chasse d'eau

Appuyez sur le bouton de la chasse d'eau afin d'actionner la petite ou la grande chasse.

Impulsion

Appuyez sur le bouton « Impulsion » afin que la pression de l'eau varie en continue de l'intensité faible à forte.

Désodorisation automatique marche/arrêt

- Appuyez sur le bouton « Désodorisation » afin d'éliminer les odeurs émanant de l'intérieur de la cuvette.

Nettoyage de la buse

- Appuyez sur le bouton « Nettoyage de la buse » afin de nettoyer la buse en position avancée.

< DEVANT >

Stop

- Afin de stopper le fonctionnement en cours, appuyez sur le bouton « Stop ».

Postérieur/Nettoyage à impulsions

- Appuyez une fois sur le bouton afin d'effectuer le nettoyage du postérieur (zone arrière du corps).
- Pour effectuer le nettoyage à impulsions, appuyez de nouveau sur le bouton pendant que le nettoyage du postérieur est en cours.
- Durant le nettoyage à impulsions, la buse se déplace afin de nettoyer largement la zone et offre un effet de massage à impulsions en changeant la pression de l'eau.

Nettoyage de la zone intime de la femme

- Zone intime de la femme/Nettoyage à impulsions
- Appuyez une fois sur le bouton afin d'effectuer le nettoyage de la zone intime de la femme (zone frontale du corps).
- Pour effectuer le nettoyage à impulsions, appuyez de nouveau sur le bouton pendant que le nettoyage de la zone intime est en cours.
- Durant le nettoyage à impulsions, la buse se déplace afin de nettoyer largement la zone et offre un effet de massage à impulsions en changeant la pression de l'eau.

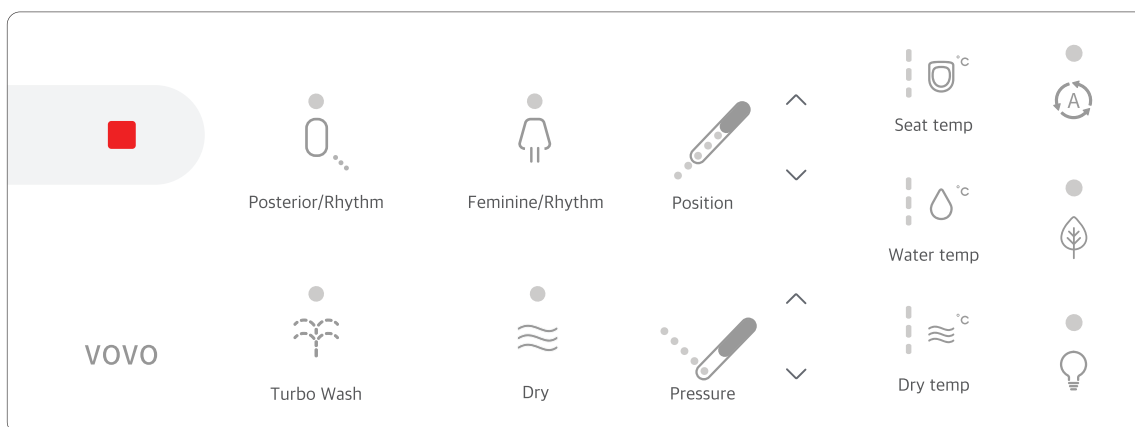

Position

- La position de la buse est réglable sur 5 niveaux.

Température du siège

- Le bouton « Température du siège » vous permet de régler la température du siège sur 3 niveaux.

Chasse d'eau automatique marche/arrêt

- Cette fonction distingue l'urine des matières fécales.

Nettoyage turbo

- Appuyez sur le bouton « Nettoyage turbo » afin d'activer le jet d'eau permettant de vous laver à partir de la buse.

Séchage

- Séchez l'eau après avoir utilisé les fonctions du nettoyage du postérieur, de la zone intime de la femme et du nettoyage turbo.
- Il faut du temps pour sécher complètement.

Pression

- Il est possible de régler la pression de l'eau sur 5 niveaux pour le nettoyage du postérieur, de la zone intime de la femme et du nettoyage turbo.

Température de l'eau

- Il est possible de régler la température de l'eau sur 3 niveaux pour le nettoyage du postérieur et de la zone intime de la femme, ainsi que pour le lavement.

Température de séchage

- La température de séchage est réglable sur 3 niveaux.

Mode d'économie d'énergie

- En mode d'économie d'énergie, la température de l'eau et celle du siège se réglent de manière efficace lorsqu'elles ne sont pas utilisées pendant plus d'1h.
- Lorsque les toilettes sont utilisées de nouveau, la température revient au réglage initial.

Lumière LED UV marche/arrêt (Option)

- La LED UV tue les germes et les bactéries et stérilise le bol.
- Lorsque les fonctions de la lumière LED d'UV est activée, celle-ci va être allumée et s'éteint automatiquement lorsqu'on s'assoit.



Mando a distancia

- RTB 090W

SPANISH

<Parte superior>



Botón de descarga (completa - pequeña)

-Presione el botón de descarga para activar la descarga completa o pequeña.

Encendido/Apagado de la desodorización automática

-Presione el botón de desodorización para eliminar el olor del interior de la taza.

Pulsante

-presione el botón pulsante para repetir la intensidad de la presión del agua de fuerte a débil.

Limpieza de la boquilla

-Presione el botón de limpieza de la boquilla para limpiarla hacia el frente.

<Parte frontal>

Detener

-Para detener la función que se está utilizando, presione el botón DETENER.

Posterior/Ritmo

-Realiza el lavado posterior (zona posterior del cuerpo) cuando se presiona el botón una vez.
-Realiza la función Ritmo cuando se presiona de nuevo el botón mientras la función posterior está activa.
-Durante la función Ritmo, la boquilla se moverá para la var una zona amplia y generar un efecto de masaje pulsante con cambios en la presión del agua.

Femenino/Ritmo

-Realiza el lavado femenino (zona frontal del cuerpo) cuando se presiona el botón una vez.
-Realiza la función Ritmo cuando se presiona de nuevo el botón mientras la función femenino está activa.
-Durante la función Ritmo, la boquilla se moverá para lavar una zona amplia y generar un efecto de masaje pulsante con cambios en la presión del agua.

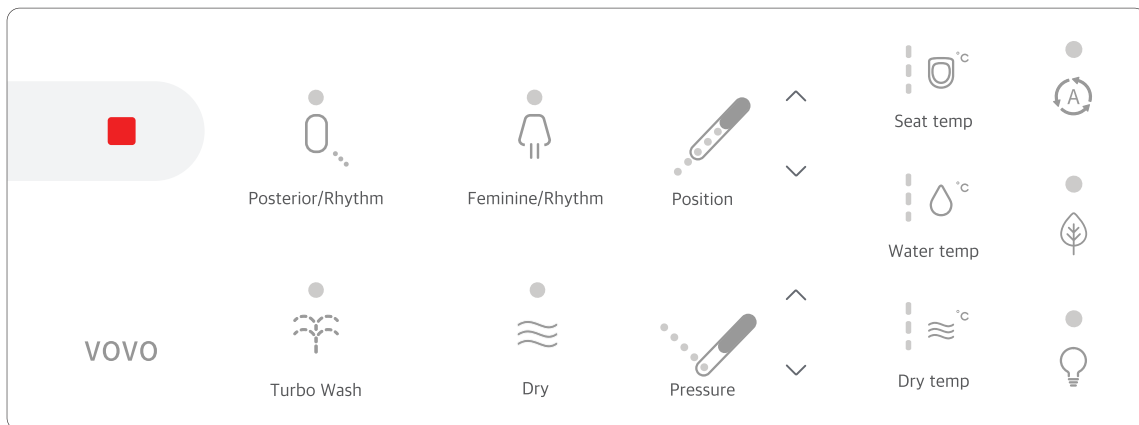

Posición

-La posición de la boquilla puede ser ajustada en cinco niveles.

Temperatura del asiento

-El botón de temperatura del asiento del retrete puede ajustar su temperatura en tres niveles.

Encendido/Apagado de la descarga automática

-El sensor del asiento detecta al usuario y descarga de manera automática diferenciando entre descargas grandes y pequeñas. Esto en función del tiempo que el usuario permanezca sentado.

Lavado turbo

-Presione el botón de lavado turbo para activar el chorro de agua de lavado desde la boquilla.

Secado

-Seca el agua después de utilizar las funciones de lavado posterior, lavado femenino y lavado turbo.

Encendido/Apagado del ahorro de energía

-En el modo de ahorro de energía, la temperatura del agua y del asiento se ajustarán de manera eficiente cuando no se haya utilizado por más de una hora.
-Cuando se use de nuevo el producto, la temperatura volverá a la configuración original.

Presión

-Es posible ajustar la presión del agua del lavado posterior, lavado femenino y lavado turbo en cinco niveles.

Temperatura del agua

-Es posible ajustar la temperatura del agua del lavado posterior, lavado femenino y lavado turbo en cinco niveles.

Apertura/Cierre automático de la tapa

-Cuando se ubique delante del retrete o se aleje de este, la tapa se abrirá o cerrará respectivamente de manera automática.

Temperatura del asiento

-El botón de temperatura del asiento del retrete puede ajustar su temperatura en tres niveles.

Opción de encendido/apagado de la luz LED UV

-La luz LED UV elimina gérmenes y bacterias a la vez que esteriliza la taza.
-Cuando la función LED UV esté activada, el LED UV se encenderá, y se apagará de manera automática mientras esté sentado.

Remote Control

- TCB 8100B / TCB 8100W

< TOP >

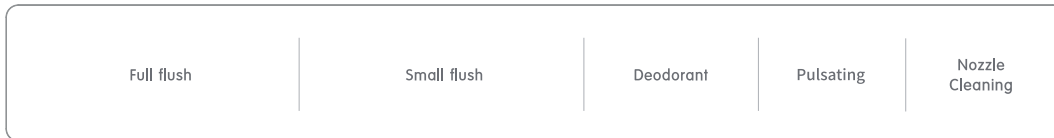

Flush (Full. Small) Button

- Press the flush button to activate the full or small flush.

Pulsating

- Press the pulsating button to repeat the intensity of the water pressure from strong to weak.

Auto Deodorant ON / OFF

- Press the deodorant button to remove the odor inside the bowl.

Nozzle Cleaning

- Press the nozzle cleaning button to clean the nozzle in a moving forward position.

< Front >

Stop

- To stop the function being used, press the STOP button.

Posterior/Rhythm

- Performs Posterior wash (Back area of the body) by pushing the button once.
 - Performs Rhythm function when pushed the button again while the posterior function is on the process.
 - During Rhythm function, the nozzle will move to wash wide area and provide pulsating massage effect with changing water pressure.

Feminine/Rhythm

- Performs Feminine wash (Frontal area of the body) by pushing the button once.
 - Performs Rhythm function when pushed the button again while the feminine function is on the process.
 - During Rhythm function, the nozzle will move to wash wide area and provide pulsating massage effect with changing water pressure.

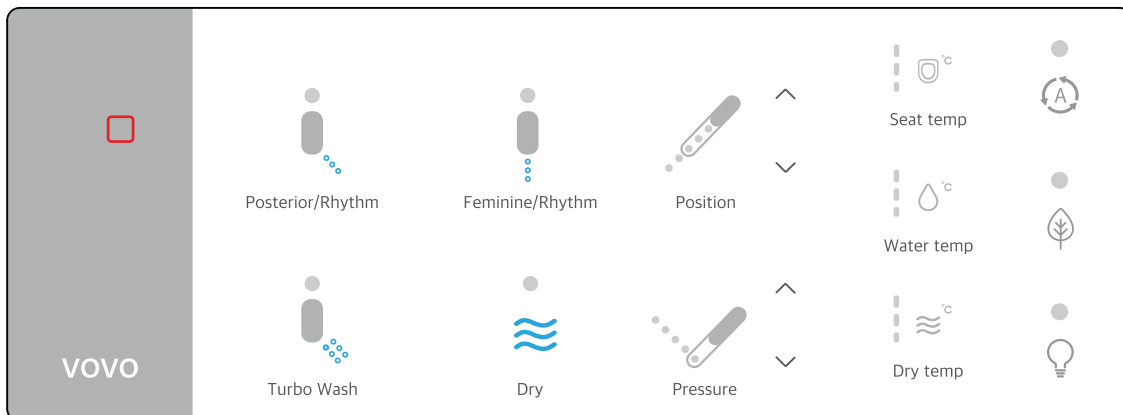

Position

- The nozzle position can be adjusted in five steps.

Turbo Wash

- Press the Turbo Wash button to activate washing water spray from the nozzle.

Pressure

- It is possible to adjust the water pressure of Posterior wash, Feminine wash, and Turbo wash in five steps.

Power Save On / OFF

- In power save mode, water temperature and seat temperature will be adjusted efficiently when not used for more than one hour.
 - When the product is used again, the temperature returns back to the original setting.

Seat Temp

- The toilet seat temperature button can adjust the temperature of the toilet seat in three steps.

Dry

- Dry off the water after using the posterior Wash, Feminine Wash, and Turbo Wash function.
 - It takes time to dry completely.

Water Temp

- It is possible to adjust the water temperature of Posterior wash, Feminine wash, and Turbo wash in three steps.

UV LED Light ON / OFF (Option)

- UV LED eliminates germs and bacteria as well as sterilizing the bowl.
 - When UV LED function is activated, UV LED will turn on and it will automatically turn off while seated.

Auto Flush ON/OFF

- The seat sensor detects user's seating and flushes automatically by differentiating large and small flushes based on user's seated time. (Less than 2mins, small flush / more than 2 mins, large flush)

Dry Temp

- The temperature of the drying function can be adjusted in three steps.

Télécommande

- TCB 8100B / TCB 8100W

FRENCH

< DESSUS >

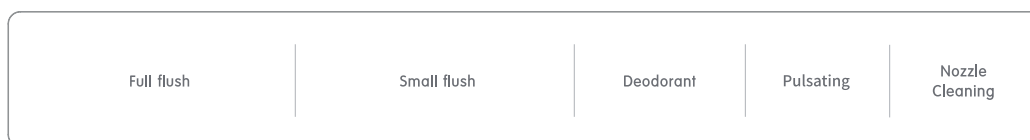

Bouton (petite/grande) chasse d'eau

Appuyez sur le bouton de la chasse d'eau afin d'actionner la petite ou la grande chasse.

Impulsion

Appuyez sur le bouton « Impulsion » afin que la pression de l'eau varie en continue de l'intensité faible à forte.

Désodorisation automatique marche/arrêt

- Appuyez sur le bouton « Désodorisation » afin d'éliminer les odeurs émanant de l'intérieur de la cuvette.

Nettoyage de la buse

- Appuyez sur le bouton « Nettoyage de la buse » afin de nettoyer la buse en position avancée.

< DEVANT >

Stop

- Afin de stopper le fonctionnement en cours, appuyez sur le bouton « Stop ».

Postérieur/Nettoyage à impulsions

- Appuyez une fois sur le bouton afin d'effectuer le nettoyage du postérieur (zone arrière du corps).
- Pour effectuer le nettoyage à impulsions, appuyez de nouveau sur le bouton pendant que le nettoyage du postérieur est en cours.
- Durant le nettoyage à impulsions, la buse se déplace afin de nettoyer largement la zone et offre un effet de massage à impulsions en changeant la pression de l'eau.

Nettoyage de la zone intime de la femme

- Zone intime de la femme/Nettoyage à impulsions
- Appuyez une fois sur le bouton afin d'effectuer le nettoyage de la zone intime de la femme (zone frontale du corps).
- Pour effectuer le nettoyage à impulsions, appuyez de nouveau sur le bouton pendant que le nettoyage de la zone intime est en cours.
- Durant le nettoyage à impulsions, la buse se déplace afin de nettoyer largement la zone et offre un effet de massage à impulsions en changeant la pression de l'eau.

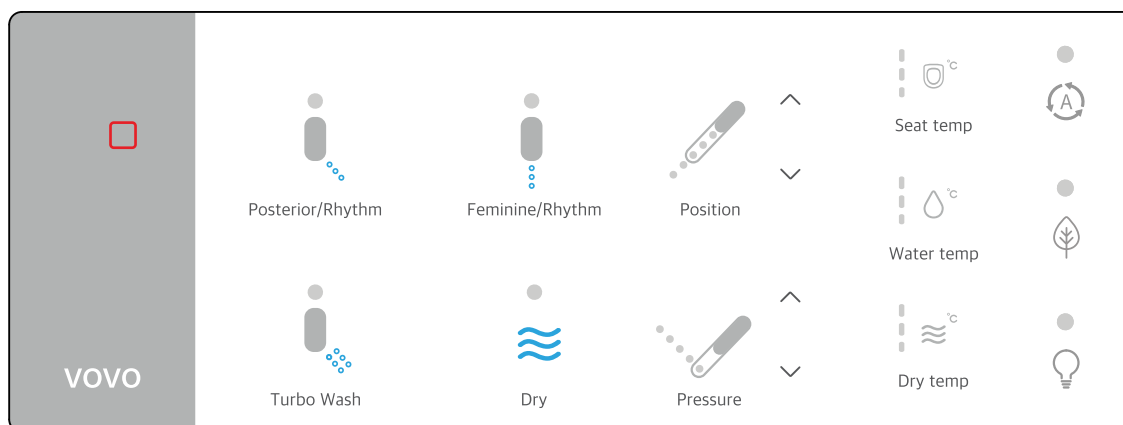

Position

- La position de la buse est réglable sur 5 niveaux.

Température du siège

- Le bouton « Température du siège » vous permet de régler la température du siège sur 3 niveaux.

Chasse d'eau automatique marche/arrêt

- Cette fonction distingue l'urine des matières fécales.

Nettoyage turbo

- Appuyez sur le bouton « Nettoyage turbo » afin d'activer le jet d'eau permettant de vous laver à partir de la buse.

Séchage

- Séchez l'eau après avoir utilisé les fonctions du nettoyage du postérieur, de la zone intime de la femme et du nettoyage turbo.
- Il faut du temps pour sécher complètement.

Pression

- Il est possible de régler la pression de l'eau sur 5 niveaux pour le nettoyage du postérieur, de la zone intime de la femme et du nettoyage turbo.

Température de l'eau

- Il est possible de régler la température de l'eau sur 3 niveaux pour le nettoyage du postérieur et de la zone intime de la femme, ainsi que pour le lavement.

Température de séchage

- La température de séchage est réglable sur 3 niveaux.

Mode d'économie d'énergie

- En mode d'économie d'énergie, la température de l'eau et celle du siège se règlent de manière efficace lorsqu'elles ne sont pas utilisées pendant plus d'1h.
- Lorsque les toilettes sont utilisées de nouveau, la température revient au réglage initial.

Lumière LED UV marche/arrêt (Option)

- La LED UV tue les germes et les bactéries et stérilise le bol.
- Lorsque les fonctions de la lumière LED d'UV est activée, celle-ci va être allumée et s'éteint automatiquement lorsqu'on s'assoit.



Mando a distancia

SPANISH

- TCB 8100B / TCB 8100W

<Parte superior>

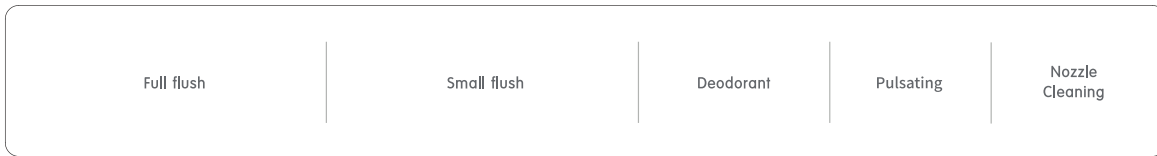

Botón de descarga (completa - pequeña)

-Presione el botón de descarga para activar la descarga completa o pequeña.

Encendido/Apagado de la desodorización automática

-Presione el botón de desodorización para eliminar el olor del interior de la taza.

Pulsante

-presione el botón pulsante para repetir la intensidad de la presión del agua de fuerte a débil.

Limpieza de la boquilla

-Presione el botón de limpieza de la boquilla para limpiarla hacia el frente.

<Parte frontal>

Detener

-Para detener la función que se está utilizando, presione el botón DETENER.

Posterior/Ritmo

-Realiza el lavado posterior (zona posterior del cuerpo) cuando se presiona el botón una vez.
-Realiza la función Ritmo cuando se presiona de nuevo el botón mientras la función posterior está activa.
-Durante la función Ritmo, la boquilla se moverá para la var una zona amplia y generar un efecto de masaje pulsante con cambios en la presión del agua.

Femenino/Ritmo

-Realiza el lavado femenino (zona frontal del cuerpo) cuando se presiona el botón una vez.
-Realiza la función Ritmo cuando se presiona de nuevo el botón mientras la función femenino está activa.
-Durante la función Ritmo, la boquilla se moverá para lavar una zona amplia y generar un efecto de masaje pulsante con cambios en la presión del agua.

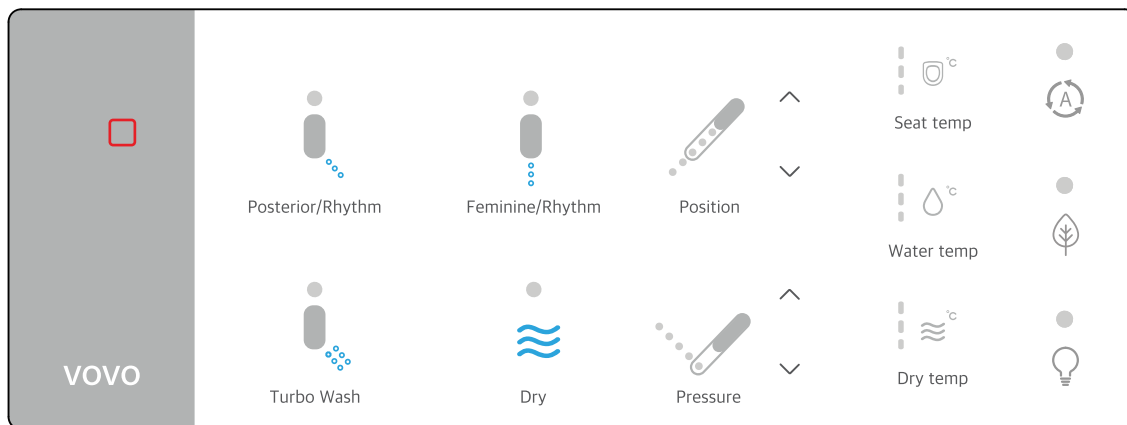

Posición

-La posición de la boquilla puede ser ajustada en cinco niveles.

Temperatura del asiento

-El botón de temperatura del asiento del retrete puede ajustar su temperatura en tres niveles.

Encendido/Apagado de la descarga automática

-El sensor del asiento detecta al usuario y descarga de manera automática diferenciando entre descargas grandes y pequeñas. Esto en función del tiempo que el usuario permanezca sentado.

Lavado turbo

-Presione el botón de lavado turbo para activar el chorro de agua de lavado desde la boquilla.

Secado

-Seca el agua después de utilizar las funciones de lavado posterior, lavado femenino y lavado turbo.

Encendido/Apagado del ahorro de energía

-En el modo de ahorro de energía, la temperatura del agua y del asiento se ajustarán de manera eficiente cuando no se haya utilizado por más de una hora.
-Cuando se use de nuevo el producto, la temperatura volverá a la configuración original.

Presión

-Es posible ajustar la presión del agua del lavado posterior, lavado femenino y lavado turbo en cinco niveles.

Temperatura del agua

-Es posible ajustar la temperatura del agua del lavado posterior, lavado femenino y lavado turbo en cinco niveles.

Apertura/Cierre automático de la tapa

-Cuando se ubique delante del retrete o se aleje de este, la tapa se abrirá o cerrará respectivamente de manera automática.

Temperatura del asiento

-El botón de temperatura del asiento del retrete puede ajustar su temperatura en tres niveles.

Opción de encendido/apagado de la luz LED UV

-La luz LED UV elimina gérmenes y bacterias a la vez que esteriliza la taza.
-Cuando la función LED UV esté activada, el LED UV se encenderá, y se apagará de manera automática mientras esté sentado.

How to Use

1 Sit on the seat

- The seat lamp will turn on.
- It operates after being occupied

2 Press the flush button on the remote control

- Only needs to be done after the first time of installation
- Water will fill the toilet to an appropriate level.

3

Press posterior /rhythm  or Turbo wash 

Press feminine /rhythm 

Advice 1

- It works for 1 minute.

How to use Turbo wash properly. **Advice 2**

- Press Turbo wash , set the water spray to the center of anus.
- Control the water pressure.
- If you feel that the water has filled you up, push the water out by forcing the abdomen.

4 Press Stop

- Press stop to stop the operation of Posterior, Feminine, and Turbo wash.

5 Full flush Small flush

Press Flush

6 Press Dry

- It works up to 3 minutes.

7 Press Stop

◆ How to use it more comfortably ◆

Comfortable 1 Rhythm

Enjoy Oscillating and Pulsating all together.

-  Press the button to wash.
Posterior /Rhythm Feminine /Rhythm
- Press the button again to perform rhythm function.
- In rhythm function, nozzle will move to wash wide area and provide pulsating massage effect with changing water pressure.
- Press the button once more if you want to stop the rhythm function.

Advice 1 Do not sit on the edge, but toward the inside of seat.

Advice 2 Comfortable functions don't work with Turbo wash.
Turbo wash wash starts from the lowest water pressure.

Remote Control

ENGLISH

< TOP >

PB-707S

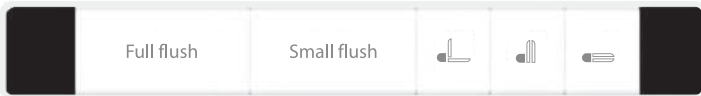

PB-101S

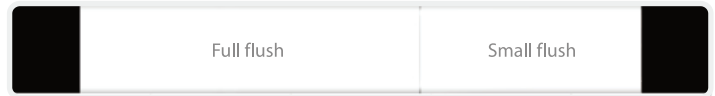

Flush (Full. Small) Button

- Press the flush button to activate the full or small flush.

Cover and Seat Opening

- When you press the cover or toilet seat buttons, both the toilet seat cover and the toilet seat are automatically open and closed.

Seat Cover Opening/Closing

- Press the seat cover button to automatically open and close the toilet seat cover

Seat Cover and Seat Closing

- Press the close button to close both the toilet seat cover and toilet seat.

< Front >

< COVER CLOSE >

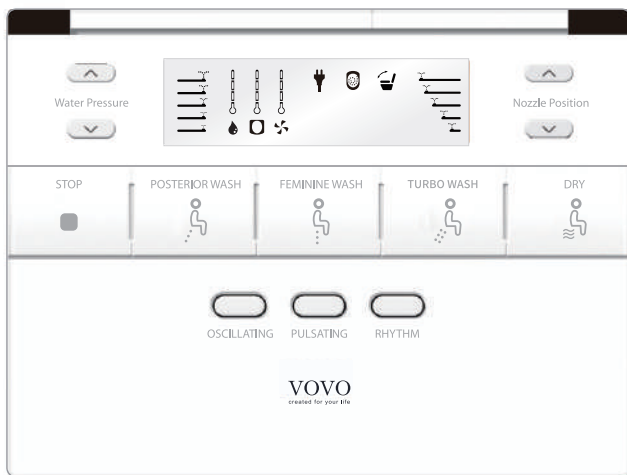

< COVER OPEN >

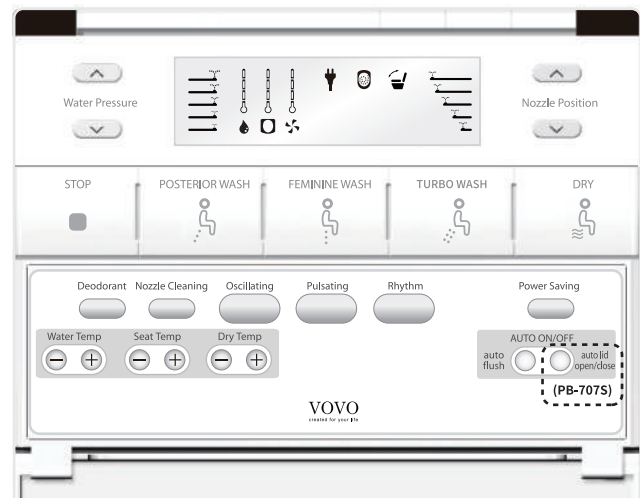

Water Pressure

- It is possible to adjust the water pressure of Posterior wash, Feminine wash, and Turbo wash in five steps.

Nozzle Position

- The nozzle position can be adjusted in five steps.

Stop

- To stop the function being used, press the STOP button.

Posterior Wash

- Press the posterior button to activate washing water spray from the nozzle.

Feminine Wash

- Press the feminine button to activate washing water spray from the nozzle.

Turbo Wash

- Press the Turbo Wash button to activate washing water spray from the nozzle.

Dry

- Dry off the water after using the posterior Wash, Feminine Wash, and Turbo Wash function.
- It takes time to dry completely.

Deodorant ON / OFF

- Press the deodorant button to remove the odor inside the bowl.

Nozzle Cleaning

- Press the nozzle cleaning button to clean the nozzle in a moving forward position.

Oscillating

- When you press the move button, the nozzle moves forward and backward.

Pulsating

- Press the pulsating button to repeat the intensity of the water pressure from strong to weak.

Rhythm

- If you push 'Rhythm' button during the posterior Wash or Feminine function, nozzle will move to wash wide area and provide pulsating massage effect with changing water pressure.

Power saving ON / OFF

- You can turn the power saving function ON / OFF feminine key. to save the unused time and electricity cost.

Water Temp

- It is possible to adjust the water temperature of Posterior wash, Feminine wash, and Turbo wash in three steps.

Seat Temp

- The toilet seat temperature button can adjust the temperature of the toilet seat in three steps.

Dry Temp

- The temperature of the drying function can be adjusted in three steps.

Auto Flush ON/OFF

- The seat sensor detects user's seating and flushes automatically by differentiating large and small flushes based on user's seated time.
(Less than 2mins, small flush / more than 2 mins, large flush)

(PB-707S) Auto Lid Open / Close

- When you stand in front of the toilet, the lid automatically opens, and when you move away from the toilet, the lid automatically closes.

Remote Control

FRENCH

〈 TOP 〉

PB-707S

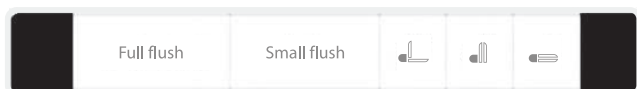

Bouton (petite/grande) chasse d'eau

Appuyez sur le bouton de la chasse d'eau afin d'actionner la petite ou la grande chasse.

Ouverture du couvercle et du siège des toilettes

- Lorsque vous appuyez sur les boutons du couvercle ou du siège des toilettes, le couvercle et le siège s'ouvrent et se ferment automatiquement.

PB-101S



Fermeture du couvercle et du siège des toilettes

- Appuyez sur le bouton « Fermeture » afin de fermer à la fois le couvercle et le siège des toilettes.

〈 Front 〉

〈 COVER CLOSE 〉

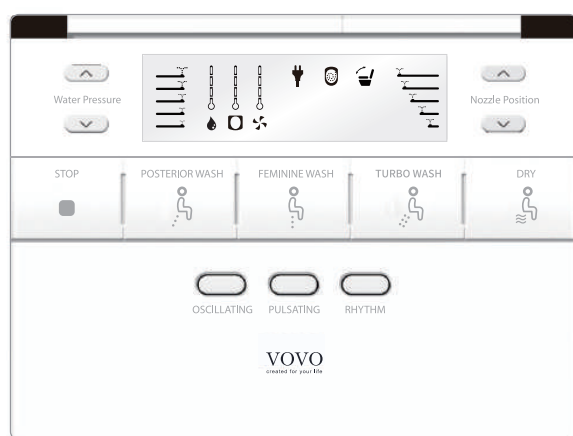

〈 COVER OPEN 〉

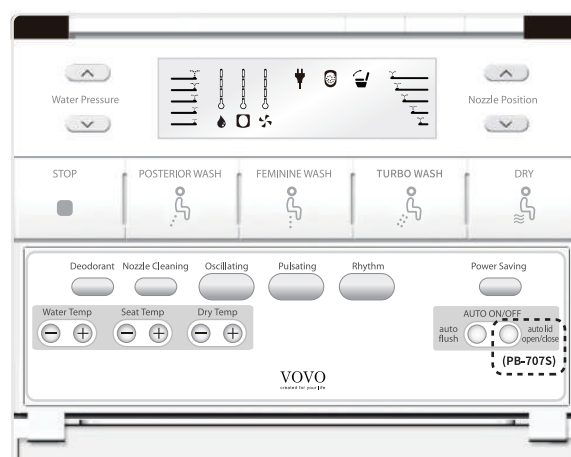

Température de l'eau

- Il est possible de régler la température de l'eau sur 3 niveaux pour le nettoyage du postérieur et de la zone intime de la femme, ainsi que pour le lavement.

Lavage postérieur

- Appuyez sur le bouton postérieur pour activer le jet d'eau de lavage de la buse.

Séchage

- Séchez l'eau après avoir utilisé les fonctions du nettoyage du postérieur, de la zone intime de la femme et du nettoyage turbo.
- Il faut du temps pour sécher complètement.

Oscillant

- When you press the move button, the nozzle moves forward and backward.

Éclairage marche/arrêt

- La lumière s'allume dans la partie inférieure des toilettes. Vous pouvez activer ou désactiver la fonction d'éclairage afin de pouvoir utiliser votre salle de bains ou vos toilettes dans le noir, sans aucune lumière.

Pression

- Il est possible de régler la pression de l'eau sur 5 niveaux pour le nettoyage du postérieur, de la zone intime de la femme et du nettoyage turbo.

Position

- La position de la buse est réglable sur 5 niveaux.

Nettoyant féminin

- Appuyez sur le bouton féminin pour activer le jet d'eau de lavage de la buse.

Désodorisation automatique marche/arrêt

- Appuyez sur le bouton « Désodorisation » afin d'éliminer les odeurs émanant de l'intérieur de la cuvette.

Palpitant

- Appuyez sur le bouton de pulsation pour répéter l'intensité de la pression de l'eau de forte à faible.

Séchage

- Séchez l'eau après avoir utilisé les fonctions du nettoyage du postérieur, de la zone intime de la femme et du nettoyage turbo.

Ouverture/Fermeture automatique du couvercle

- Le couvercle s'ouvre automatiquement lorsque vous vous tenez debout devant les toilettes. Et il se ferme automatiquement lorsque vous vous éloignez des toilettes.

Stop

- Afin de stopper le fonctionnement en cours, appuyez sur le bouton « Stop ».

Nettoyage turbo

- Appuyez sur le bouton « Nettoyage turbo » afin d'activer le jet d'eau permettant de vous laver à partir de la buse.

Nettoyage de la buse

- Appuyez sur le bouton « Nettoyage de la buse » afin de nettoyer la buse en position avancée.

Rythme

- Si vous appuyez sur le bouton « Rythme » pendant la fonction Lavage postérieur ou Féminin, la buse se déplacera pour laver une large zone et fournira un effet de massage pulsé avec une pression d'eau changeante.

Température du siège

- Le bouton « Température du siège » vous permet de régler la température du siège sur 3 niveaux.

(PB-707S)

Éclairage automatique marche/arrêt

- La lumière s'allume dans la partie inférieure des toilettes. Vous pouvez activer ou désactiver la fonction d'éclairage afin de pouvoir utiliser votre salle de bains ou vos toilettes dans le noir, sans aucune lumière.

Remote Control

SPANISH

<Parte superior>

PB-707S

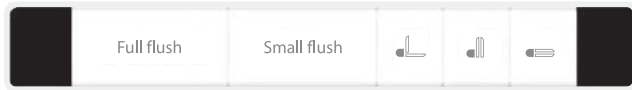

PB-101S



Botón de descarga (completa - pequeña)

-Presione el botón de descarga para activar la descarga completa o pequeña.

Apertura/Cierre de la tapa del asiento

-Presione el botón de la tapa del asiento del retrete para abrirla o cerrarla de manera automática.

Cierre de la tapa y del asiento

-Presione el botón de cierre para cerrar tanto la tapa del asiento como el asiento del retrete.

Apertura de la tapa y del asiento

-Al presionar el botón de la tapa del asiento o del asiento del retrete, ambos se abren o se cierran de manera automática.

<Parte frontal>

< COVER CLOSE >

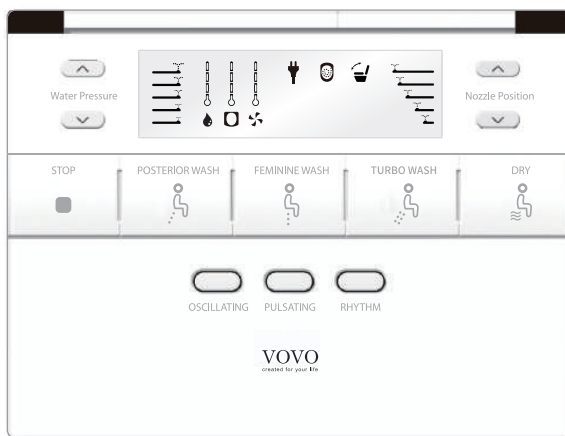

< COVER OPEN >

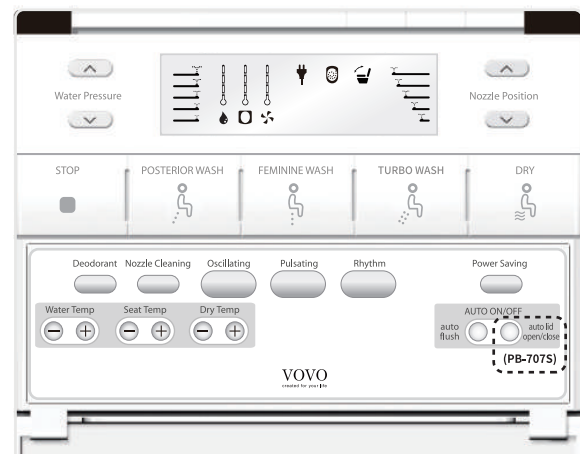

Posición

-La posición de la boquilla puede ser ajustada en cinco niveles.

Presión

-Es posible ajustar la presión del agua del lavado posterior, lavado femenino y lavado turbo en cinco niveles.

Detener

-Para detener la función que se está utilizando, presione el botón DETENER.

Posterior

-Realiza el lavado posterior (zona posterior del cuerpo) cuando se presiona el botón una vez.

Femenino

-Realiza el lavado femenino (zona frontal del cuerpo) cuando se presiona el botón una vez.

Lavado turbo

-Presione el botón de lavado turbo para activar el chorro de agua de lavado desde la boquilla.

Secado

-Seca el agua después de utilizar las funciones de lavado posterior, lavado femenino y lavado turbo.

Encendido/Apagado de la desodorización automática

-Presione el botón de desodorización para eliminar el olor del interior de la taza.

Limpieza de la boquilla

-Presione el botón de limpieza de la boquilla para limpiarla hacia el frente.

Oscilante

-Cuando presiona el botón de movimiento, la boquilla se mueve hacia adelante y hacia atrás.

pulsante

-presione el botón pulsante para repetir la intensidad de la presión del agua de fuerte a débil

Ritmo

-Durante la función Ritmo, la boquilla se moverá para lavar una zona amplia y generar un efecto de masaje pulsante con cambios en la presión del agua.

Encendido/Apagado del ahorro de energía

-En el modo de ahorro de energía, la temperatura del agua y del asiento se ajustarán de manera eficiente cuando no se haya utilizado por más de una hora.
-Cuando se use de nuevo el producto, la temperatura volverá a la configuración original.

Temperatura del asiento

-El botón de temperatura del asiento del retrete puede ajustar su temperatura en tres niveles.

Temperatura del agua

-Es posible ajustar la temperatura del agua del lavado posterior, lavado femenino y lavado turbo en cinco niveles.

Temperatura de secado

-La temperatura de la función de secado puede ser ajustada en tres niveles.

Encendido/Apagado de la descarga automática

-El sensor del asiento detecta al usuario y descarga de manera automática diferenciando entre descargas grandes y pequeñas. Esto en función del tiempo que el usuario permanezca sentado.

Apertura/Cierre automático de la tapa (PB 707S)

-Cuando se ubique delante del retrete o se aleje de este, la tapa se abrirá o cerrará respectivamente de manera automática.

How to Use

1 Sit on the seat

- The seat lamp will turn on.
- It operates after being occupied

2 Press the flush button on the remote control

- (Only when using the product for the first time after installation)
- Water will fill the toilet to an appropriate level.

3



Press Posterior wash or Turbo wash.

Press Feminine wash.

Advice 1

- It works for one minute at each function.

How to use wash properly.

- Press wash, set the water spray to the center of anus.
- Control water pressure.
- If you feel that the water has filled you up a bit, push the water and motions out by forcing the abdomen.
- Pass motions and the water in a rectum completely.

4

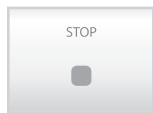

Press Stop

- Stops Posterior wash, Feminine wash and Turbo wash.

5

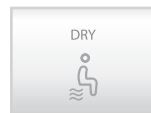

Press Dry

- It works for 3 minutes.

6

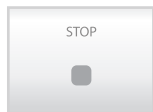

Press Stop

7



Press Flush

◆ How to use it more comfortably ◆

Comfortable 1 Oscillating

Nozzle moves back and forth to cleanse.

1. Press the button to wash.

2. Press Oscillating.
- Nozzle moves while washing.

3. Press again.
- Stop Oscillating.

Comfortable 2 Pulsating

Stream water more rhythmically.

1. Press the button to wash.

2. Press Pulsating.
- Spray Pulsating while washing

3. Press again.
- Stop Pulsating.

Comfortable 3 Rhythm

Enjoy Oscillating and Pulsating all together.

1. Press the button to wash.

2. Press Rhythm.
- Spray water rhythmically.

3. Press again.
- Stop Rhythm.

Advice 1 Do not sit on the edge, but toward the inside of seat.
This way lessens water splash in a proper position.

Flushing

Remote Control Toilet Flush

Press the button on the remote control.

- TCB 090SA / TCB 090S
- RTB 090WA / RTB 090W
- TCB 8100B / TCB 8100W
- PB-707S/PB-101S



Auto Flush

When you press the auto on/off button, auto flush sets up and the LED turns on.

- TCB 090SA / TCB 090S
- RTB 090WA / RTB 090W
- TCB 8100B / TCB 8100W

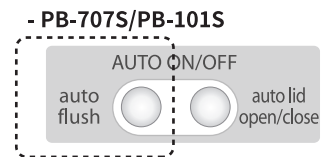
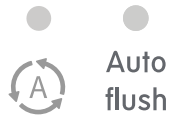

When the batteries are running low

- Press the flush button on the control panel of the main body.

TCB 090SA / TCB 090S
RTB 090WA / RTB 090W

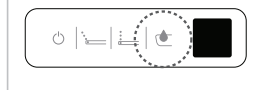

PB-707S / PB-101S

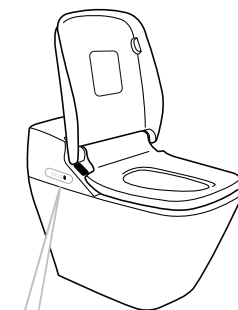

TCB 8100B / TCB 8100W



Flushing the toilet when power is out

- Open the main body cover for toilet flushing.
- 1. Press the Bowl cleaning button for 3 seconds
- 2. Press the Flush button for 5 seconds.
- 3. Press the Bowl cleaning button again for 3 seconds.

- ※ Bowl cleaning function is to clean the inner ceramic bowl.
- ※ Flush function is for jet high pressure water to flush down the soil in the bowl.

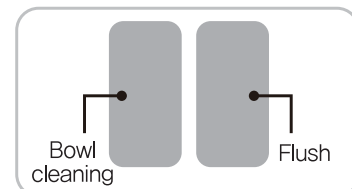

Open and Close the Toilet Seat and Lid

TCB 090SA / RTB 090WA / PB-707S

There are 2 settings for opening and closing toilet seat and lid.

The remote controlled setting and the automatic setting.

Remote Controlled Open/Close of Toilet Seat and Lid

- The toilet seat and lid can be opened and closed by pressing the specific button on the remote control.

● Press the specific button on the remote controller.

- TCB 090SA



- RTB 090WA



- PB-707S



The toilet seat and lid open and close

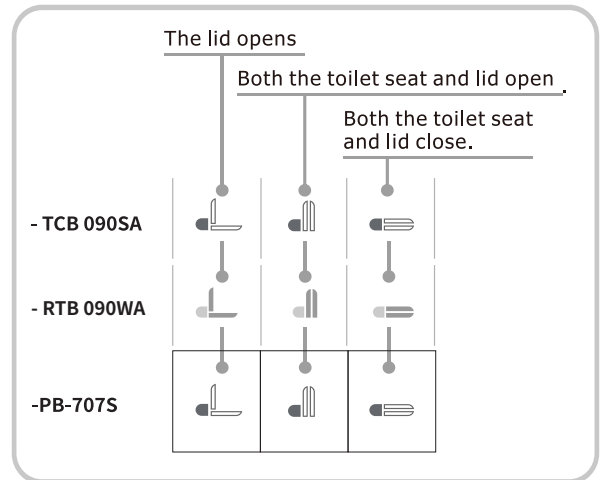

Automatic Open/Close of Toilet Seat and Lid

- When you stand in front of the toilet, the lid automatically opens, and when you move away from the toilet, the lid automatically closes.

* Check Auto Lid Open / Close

- TCB 090SA

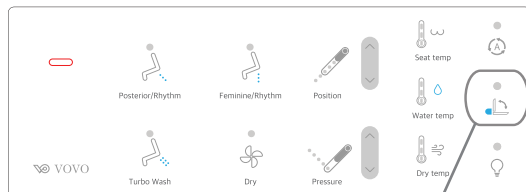

- RTB 090WA

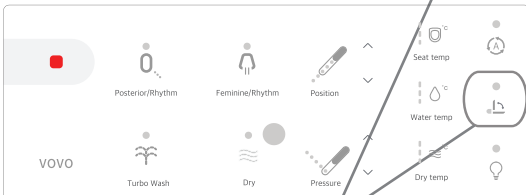

Auto Lid open/close button.

-PB-707S

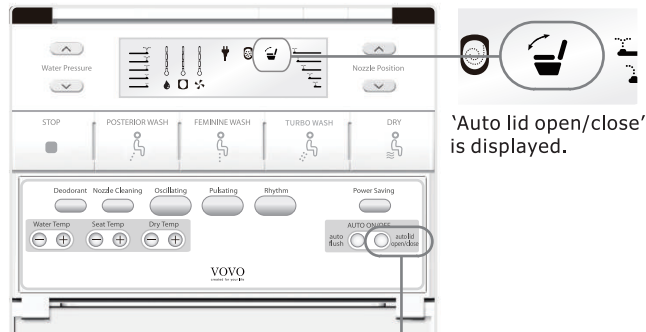

Auto Lid open/close button.

Maintenance

Caution

Make sure that auto flush function is turned off.
Please refer to the remote control/control panel pages.

Regular Maintenance

◆ Maintaining the Main body, Seat and Lid.

- Wet a soft cloth
 - Clean with wet cloth. Advice 1·2
- When toilet detergent is stained
 - Wipe it with soft wet cloth.
- When cleaning the bathroom floor
 - If there are spots of urine around the toilet, wipe it with wet towel
- If the product is seriously contaminated
 - Wipe it with soft cloth and mild detergent,
 - Rough sponges, brushes make scratches on the surface of the product,
 - Do not use the following detergents

 <p>Prohibited</p>	<ul style="list-style-type: none"> ● Bath/toilet cleaning products ● Mold removable products ● Sink cleaning products ● Bleach ● Surfactant combined detergents
--	--



Advice 1

Tankless is an electric appliance.
Make sure water does not get into the product.

Advice 2

Keep the seat sensor, remote control transmitter and receiver clean. If sensors are not clean, the product may malfunction or will not function at all

◆ Nozzle Cleaning

- Only the nozzle will extend out without spraying water.

1 Extend the nozzle

- TCB 090SA/TCB 090S
- TCB 8100B / TCB 8100W



Rhythm

Nozzle
Cleaning

PB-707S/PB-101S

Nozzle Cleaning

– Press nozzle cleaning button on the remote control.
– The nozzle will extend out.

2 Clean the nozzle

– Use soft cloth or toothbrush to clean the nozzle.

* Do not pull out or push the nozzle by force. It may cause damage or break the nozzle.

3 Return the nozzle

- TCB 090SA/TCB 090S
- TCB 8100B / TCB 8100W



Rhythm

Nozzle
Cleaning

PB-707S/PB-101S

Nozzle Cleaning

– Press Nozzle cleaning button again.
– The nozzle returns to the original position.

* The nozzle will clean itself while it returns to the original position.
* Do not push the nozzle.
– It may cause damage or break the nozzle.

FAQ

Q :What is electrical requirements? Is it energy efficient?

A : 6 Amps at 120V, 60 Hz is necessary for this item. A separate circuit breaker is recommended. It has a power save mode which uses least amount of energy.

Q : What is the rough in of this toilet?

A : It is 12 inch rough in, same as conventional toilet. If you have shorter rough in than 11", you can use an offset flange for installation. We can send you a reference image if you need.

Q : Flushing system

A : Siphone waterjet system with no tank

Q : Power save LED light is keep flashing. (Turned off and on)

A : Please try reset first. (Unplug the cord and plug it back after 30 seconds)
If it still flashes please check the water has entered to the bidet.
(Make sure to open the valve)

Q : How long is the cord?

A : The cord for this item is 1.2m(4ft).

Q : Is the remote control waterproof?

A : No. The remote control is not waterproof.

Q : How do you clean the filter?

A : 1. Close the valve **2.** Detach the strainer filter and wash it with soft brush or toothbrush with running water to clean it.

Q : Can the lid auto open function be disabled?

A : Yes. There is an auto open and close button on the remote for users to turn on and off.

Q : How much water does it use per flush?

A : The item is equipped with smart flush which distinguishes full flush and small flush. It depends on the water pressure but in average, it is **1.12GPF.**

Q : Is there max weight for the user?

A : Max weight for this item is 400lbs.

Q : What kind of water heating system is used in this item?

A : It is using water tank heating system

Q : What is auto flush?

A : It is automatically flushed in 6 seconds after getting up from the seat.
Auto flush distinguishes full flush and small flush. The consumption depends on the water pressure. In average, it is 1.12GPF at 35psi
Less than 2 minutes : Small flush, Over than 2 minutes : Full flush

Q : The lid does not open or close repeatedly.

A : Please open the seat and the lid when you reset the bidet toilet

Troubleshooting

- If you think the product is out of order, please refer to the following first.
- If the problem is still not solved, then contact local dealer or service center.
- Please unplug the power cord when requesting for repair service.

When the water leaks, close the shutoff valve and stop the water supply.
Turn the handle right.



Comply strictly

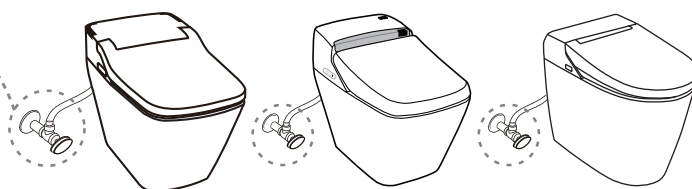

- Check the following before requesting for repair service.

Power supply

Trouble	Possible Causes	Solution
The unit is not working.	Is the power out or is the circuit breaker off?	Wait until the power is restored. Or turn on the circuit breaker.
	Is the operation lamp on the display panel of the main body off?	Turn on the power STOP in the control panel of the main body.

Posterior wash, Feminine wash, Turbo Wash

Trouble	Possible Causes	Solution
Water is not spraying out.	Is the water supply suspended?	Wait until the water supply is resumed.
	Is the shutoff valve closed?	Open the valve.
	Is the human body out of the location of seat sensor?	Refer to the Seat Sensor part.
	Is the hose twisted?	Loosen the hose.
Water pressure is weak.	Is the water pressure set to low level?	Adjust the water pressure to higher level.
	Is the strainer clogged?	Clean the strainer.

Trouble	Possible Causes	Solution
Water is cold.	Is the temperature set to a low level? Or is it turned off?	Adjust with Water temp on the remote control.
	Is it in power saving mode?	The water temperature is set lower. the temperature goes up after sitting.
Water stops in the middle of cleansing.	Press one of POSTERIOR / FEMINE / TURBO WASH buttons, then it will stop automatically in 1 minutes.	Press the POSTERIOR / FEMINE / TURBO WASH button again.
	Is the human body out of the location of seat sensor?	Refer to the location of Seat Sensor on page 8.
The water flows into toilet for a few seconds near the nozzle when sitting on the toilet.	When the seat sensor is on, it releases some water before spraying. Or if you change position while seated, the sensor will turn on and off and release some water, it is not a malfunction.	—

Heated Seat

Trouble	Possible Causes	Solution
The seat is not warm.	Is the seat temperature set to low level?	Adjust seat temperature with Seat Temp buttons on the remote control.
	Is it in power saving mode?	Sit on the seat and wait for about 5 minutes.
The seat is cold.	The heater turns off automatically 1 hour after you sit on the seat. When you stand up, the heater will turn on again.	—

Auto Flushing

Trouble	Possible Causes	Solution
Auto flushing is not working.	Is the auto flushing turned off? (When off, the flushing indication on the remote control display panel is off)	Press auto flushing Auto flush button on the remote control again to turn it on

Seat Sensor

Trouble	Possible Causes	Solution
The posterior wash or deodorant function works without sitting on the seat.	Is the seat sensor blocked with wet towel?	Remove the wet towel.
	Is the seat sensor wet?	Wipe out the water with dry cloth.

Deodorization

Trouble	Possible Causes	Solution
Deodorization is not working at all.	Is the human body out of the location of seat sensor?	Refer to the location of Seat Sensor on page 8.
Deodorization is not working at all.	Is the lamp on the main body on?	Set the deodorant function.

Power Saving

Trouble	Possible Causes	Solution
Power saving is not working.	Is it unplugged? Didn't you change batteries?	Reset the setting by pushing the power saving button from the control panel.

Remote Control

Trouble	Possible Causes	Solution
Remote control is not working.	Are the batteries running low?	Replace old batteries with new ones.
	Are the polarities of batteries misplaced?	Insert batteries in order.
	Are the transmitter, receiver of the remote control blocked?	Remove the objects blocking transmitters.
	Are the transmitter, receiver of the remote control contaminated?	Wipe out the dust or water stain.
	Is human body out of the location of seat sensor?	Refer to the location of seat sensor on page 8.

Drying

Trouble	Possible Causes	Solution
Drying air temperature is low.	Is the air temperature set to a low level?	Adjust the air temperature with Dry Temp buttons on the remote control.
The air blow stops in progress.	Press DRY then it will stop automatically after 3 minutes.	Press DRY again.
	It may stop if user changes his position while sitting.	Refer to the location of Seat Sensor on page 8.
The warm air drying function is not working at all.	Is the human body out of the location of seat sensor?	Refer to the location of Seat Sensor on page 8.

Flushing by Remote Control

Trouble	Possible Causes	Solution
I can't flush the toilet with remote control.	Are the batteries running low?	Replace old batteries with new ones.
	Did you press the button consecutively?	This function cannot be used consecutively. You will need to wait for about 10 seconds for next flush.
	Are the transmitter areas of remote control contaminated?	Clean the dust or water stain.

Others

Trouble	Possible Causes	Solution
The soil is not completely flushed down.	Is the shutoff valve opened enough?	Open the shutoff valve sufficiently.
	Is the strainer in the shutoff valve clogged?	Clean the strainer.
	Are you using water in other places than the bathroom?	—
The flushing water is not supplied.	Is the shutoff valve closed?	Open the shutoff valve sufficiently.
	Is the water supply suspended?	Wait until the water supply is resumed.
Water is leaking from the pipe joint.	Is the screw on the joint loosened?	Tighten the screw with a screwdriver.

Customer Support

Before requesting for repair service, please check <Troubleshooting>

● Limited Warranty

- This manual includes the Warranty. Please complete the appropriate information (distributor, installation date) and read the Warranty carefully.
- The warranty period is 1year from purchase date.

● Minimum storage period of replacement parts for repair use

- The minimum storage period of replacement parts for repair is 6 years from the completion of manufacture.

● In case of requesting for repair under warranty

- Please read the manual carefully again, and if there are still troubles, contact your local dealer or service center.
- Please submit the warranty card when requesting for repair service.

Information needed when requesting for repair

- | | |
|-------------------------------------|---------------------|
| - Address, name, telephone No. | - Product name |
| | - Serial Number |
| - Desired date for repairer's visit | - Installation Date |
| | - Purchase date |

Detail of Repair Charge (When requesting for customer service)

The repair cost means [Technical Support Fee] + [Part Cost] + [Traveling Expenses]

[Technical Support Fee] is required for diagnosis, repair, replacement or adjustment of parts.

[Part Cost] is the cost of the parts used for repair.

[Traveling Expenses] is required when dispatching certified technician to the location of the product.

Specifications

Model No.		TCB 090SA /RTB 090WA	TCB 090S /RTB 090W	PB-707S	PB-101S	TCB 8100B / TCB 8100W
Rated Voltage		120V~, 60Hz				
Rated Power Consumption		703W				1180W
Power Cord Length		1.2m (4ft)				
Toilet	Water Consumption	Full flush : 4.2L/1.12GPF(For 35 PSI) / Small flush : 3.8L /1.0GPF				
	Flushing System	Siphon jet, Tornado flushing				
Wash Unit	Posterior Wash	Max 540cc / min		Max 900cc / min		Max 540cc / min
	Feminine Wash	Max 1100cc / min		Max 1000cc / min		Max 1100cc / min
	Turbo Wash	Max 640cc / min		Max 700cc / min		Max 640cc / min
	Water Temperature	Adjustable, 34°C ~ 40°C / 93.2°F ~ 104°F				
	Water Tank	1200cc		1500cc		600cc
	Heater Capacity	600W				1100W
	Safety Device	Thermal cutoff, Overheating prevention circuit, Temperature sensor				
Heated Seat	Seat Temperature	Adjustable, 34°C ~ 40°C / 93.2°F ~ 104°F				
	Heater Capacity	55W				
	Safety Device	Thermal cutoff, Temperature sensor				
Dry	Hot Air Temperature	Adjustable, 40°C ~ 59°C / 104°F ~ 138.2°F				
	Heater Capacity	250W				
	Safety Device	Thermal cutoff, Temperature overheat preventer (manual recovery bimetal)				
UV LED Light		UV LED Light (Option)	—	—	—	UV LED Light (Option)
Auto Lid		Auto Lid	—	Auto Lid	—	—
Water Pressure		Min: 1.5kgf/cm2(0.15Mpa,21.3 psi), Max: 7.0kgf/cm2(0.70Mpa,106.6psi)				
Waterproof Rating		IPX4(Seat)				
Inlet Water Temperature		5°C ~ 35°C / 41°F ~ 95°F				
Ambient Temperature		5°C ~ 40°C / 41°F ~ 104°F				
Dimension		W 410 x L 725 x H 525 mm / W 16.1 x L 28.5 x H 20.6 in		W 410 x L 720 x H 570 mm / W 16.1 x L 28.3 x H 22.4 in		W 395 x L 670 x H 545 mm / W 15.5 x L 25.9 x H 21.4 in
Weight		44 kg [Bidet 9 kg, Toilet 35 kg] 97lb [Bidet 19.8lb, Toilet 77.16lb]	43 kg [Bidet 8 kg, Toilet 35 kg] 94.7lb [Bidet 17.63lb, Toilet 77.16lb]	48 kg [Bidet 13kg, Toilet 35 kg] 105.82lb [Bidet 28.66lb, Toilet 77.16lb]	47 kg [Bidet 12kg, Toilet 35 kg] 103.61lb [Bidet 26.45lb, Toilet 77.16lb]	37 kg [Bidet 7kg, Toilet 30kg] 81.57 lb [Bidet 15.43lb, Toilet 66.13lb]

WEEE Directive

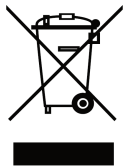

This marking shown on the product or its literature, indicates that it should not be disposed with other household wastes at the end of its working life. To prevent possible harm to the environment or human health from uncontrolled waste disposal, please separate this from other types of wastes and recycle it responsibly to promote the sustainable reuse of material resources.

Household users should contact either the retailer where they purchased this product, or their local government office, for details of where and how they can take this item for environmentally safe recycling.

Business users should contact their supplier and check the and conditions of the purchase contract. This product should not be mixed with other commercial wastes for disposal.

Limited Warranty

The product is warranted for One year with upper seat and three years with ceramic toilet bowl according to the description written on this warranty.

Please submit this warranty card to local dealer or service center.

Model :		Serial Number :	
Purchaser			
Company :			
Address :			
City :		Country :	
Phone :	Fax :	E-mail :	
Dealer(Company)			
Address :			
Installation Date :		Warranty period	
		1 year from purchase date for upper seat 3 years from purchase date for ceramic toilet bowl	

Complete the above warranty card when purchasing the product.
Check the information and keep it safe.

Pay Repair Regulations

1. Defects and/or malfunctions from failure to properly install, operate and/or maintain the unit in accordance with the installation manual.
2. Damage from abuse, fire, flood, freeze, and any other acts of nature.
3. Damage resulting from unauthorized alterations, attachments and/or repairs.
4. If the product was not installed properly for residential use.
5. Damage from installing the unit in an environment with animals, mice or insects.
6. Damage caused by excess moisture or from water clogging the water closet.
7. Damage from not being installed in accordance with all applicable local codes, ordinances and good trade practices.
8. Color fading due to use in wrong environments.
9. Damage from consumable chemicals.
10. The warranty will not be covered without providing the date of purchase with original receipt.
11. Damage from misuse due to not following the installation manual.



VOVO WARRANTY

ONE YEAR LIMITED WARRANTY FOR UPPER BIDET SEAT

THREE YEARS LIMITED WARRANTY FOR CERAMIC TOILET BOWL

1. VOVO is proud to guarantee all our products with the longest, most complete coverage warranty in the electronic bidet world. Our policies are written in more detail below.

2. This warranty does not apply to the following items:

- a. Damage or loss sustained in through any natural or man-made caused beyond the control of VOVO including to fire, earthquake, flood, thunder, electrical storm, etc.
- b. Damage or loss resulting from any accident, unreasonable use, misuse, abuse, negligence, or improper care, cleaning, or maintenance of the Product.
- c. Damage or loss resulting from sediments or foreign matter contained in a water system.
- d. Damage or loss resulting from improper installation or from installation of the Product in a harsh and/or hazardous environment, or improper removal, repair or modification of the Product. (NOTE: Product model codes allow a maximum of 80 PSI. Check local codes or standards for requirements).
- e. Damage or loss resulting from electrical surges or lightning strikes or other acts which are not the fault of VOVO or which the Product is not specified to tolerate.
- f. Damage or loss resulting from normal and customary wear and tear, such as gloss reduction, scratching or fading over time due to cleaning practices, water or atmospheric condition, including but not limited to, the use of bleach, alkali, acid cleaners, dry (powder) cleaners or any other abrasive cleaners or the use of metal or nylon scrubbers.
- g. The use of any Product in a manner inconsistent with the Product instructions / owners manual.

3. In order for this limited warranty to be valid, proof of purchase is required. VOVO encourages warranty registration upon purchase to create a record of Product ownership at <http://www.vovousa.com> Product registration is completely voluntary and failure to register will not diminish your limited warranty rights.

4. THIS WARRANTY GIVES YOU SPECIFIC LEGAL RIGHTS. YOU MAY HAVE OTHER RIGHTS WHICH VARY FROM STATE TO STATE, PROVINCE TO PROVINCE OR COUNTRY TO COUNTRY.

5. To obtain warranty repair service under this warranty, you must take the Product or deliver it prepaid to a VOVO service facility together with proof of purchase (original sales receipt) and a letter stating the problem, email to support@vovousa.com.

WARNING! VOVO shall not be responsible or liable for any failure of, or damage to, this Product caused by either chloramines in the treatment of public water supply or cleaners containing chlorine (Calcium Hypochlorite).

NOTE: The use of high concentrate chlorine or chlorine related products can seriously damage the fittings. This damage can cause leakage and serious property damage.

THIS WRITTEN WARRANTY IS THE ONLY WARRANTY MADE BY VOVO. REPAIR, REPLACEMENT OR OTHER APPROPRIATE ADJUSTMENT AS PROVIDED UNDER THIS WARRANTY SHALL BE THE EXCLUSIVE REMEDY AVAILABLE TO THE ORIGINAL PURCHASER. VOVO SHALL NOT BE RESPONSIBLE FOR LOSS OF THE PRODUCT OR FOR OTHER INCIDENTAL, SPECIAL OR CONSEQUENTIAL DAMAGES OR EXPENSES INCURRED BY THE ORIGINAL PURCHASER, OR FOR LABOR OR OTHER COSTS DUE TO INSTALLATION OR REMOVAL, OR COSTS OF REPAIRS BY OTHERS, OR FOR ANY OTHER EXPENSE NOT SPECIFICALLY STATED ABOVE. IN NO EVENT WILL VOVO'S RESPONSIBILITY EXCEED THE PURCHASE PRICE OF THE PRODUCT. EXCEPT TO THE EXTENT PROHIBITED BY APPLICABLE LAW, ANY IMPLIED WARRANTIES, INCLUDING THAT OF MERCHANTABILITY OR FITNESS FOR USE OR FOR A PARTICULAR PURPOSE, ARE EXPRESSLY DISCLAIMED. SOME STATES DO NOT ALLOW LIMITATIONS ON HOW LONG AN IMPLIED WARRANTY LASTS, OR THE EXCLUSION OR LIMITATION OF INCIDENTAL OR CONSEQUENTIAL DAMAGES, SO THE ABOVE LIMITATION AND EXCLUSION MAY NOT APPLY TO YOU.









Customer Support
E-mail : support@vovousa.com