

# CELESTE SCONCE - SMALL

---

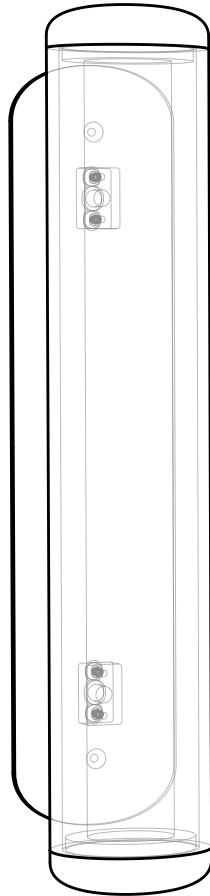

**DRAWINGS ARE NOT TO SCALE. PLEASE CONSULT A LICENSED ELECTRICIAN BEFORE INSTALLATION. DRAWINGS ARE FOR REFERENCE ONLY AND ARE SUBJECT TO PRODUCT REVISIONS. J-BOX AND J-BOX SCREWS ARE NOT INCLUDED.**

# PARTS INCLUDED

---

**SMALL  
CELESTE  
SCONCE**  
QTY 1

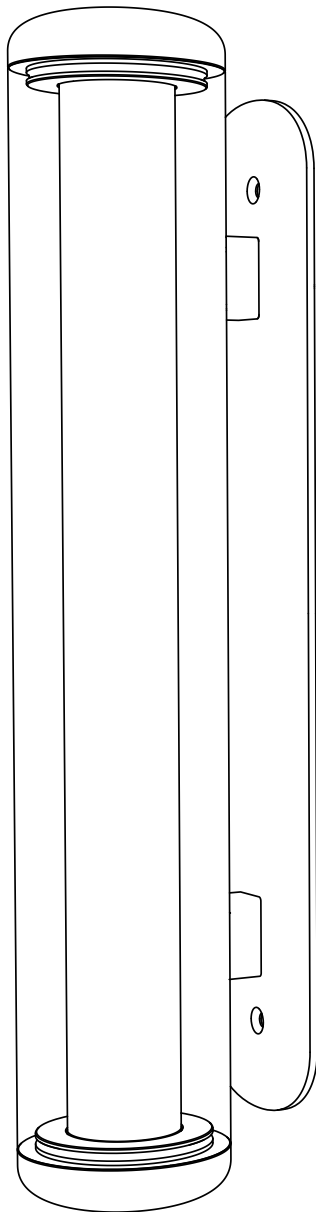

**WIRE NUTS**  
QTY 4

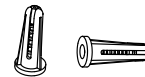

**DRYWALL  
ANCHOR**  
QTY 1

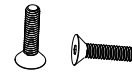

**#8-32 HEX  
SCREWS**  
QTY 2

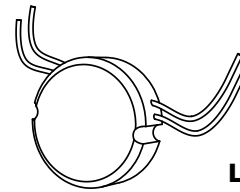

**LED  
DRIVER**  
QTY 1

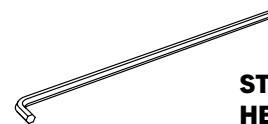

**STUBBY  
HEX KEY**  
QTY 1



**J-BOX INSTALLATION: PLANNING FOR YOUR NEW FIXTURE**

When planning for your fixture placement, J-box must be installed offset from horizontal center of small sconce by 5.125". See diagram below for more information.

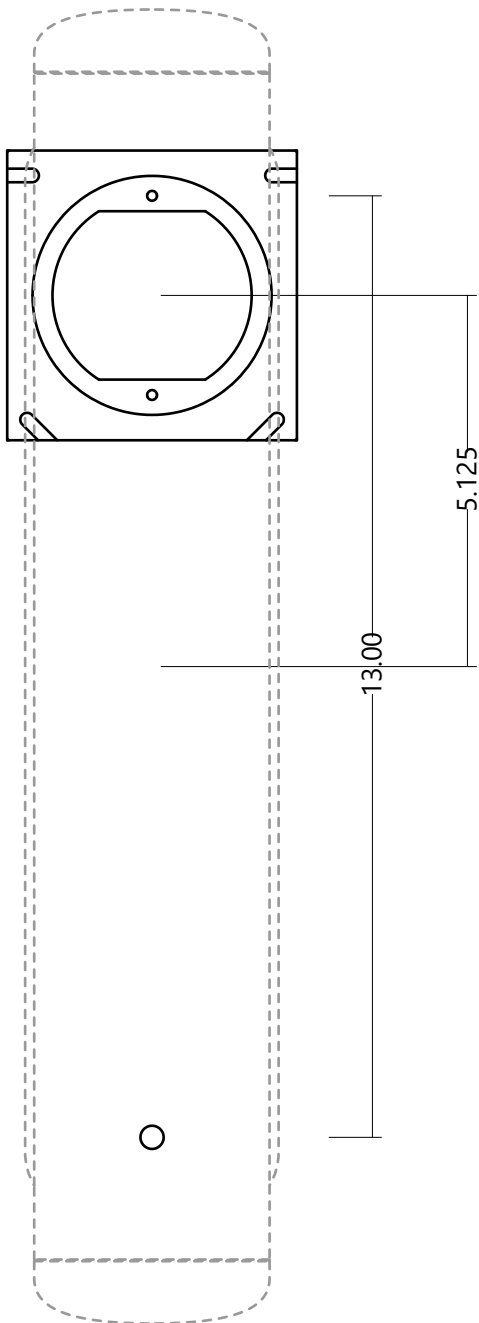

**CAUTION: PRIOR TO BEGINNING INSTALLATION, CUT ELECTRICAL POWER TO J-BOX.**

1. Drill 3/16" drywall anchor hole exactly 13" from the top #8-32 hole in a standard 4" round mud ring.

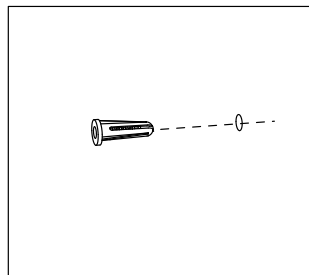

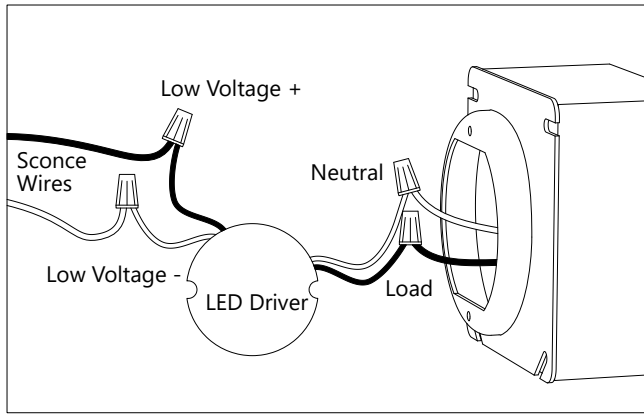

2. Wire LED driver to 120VAC power and then to the Sconce according to the diagram on the left.

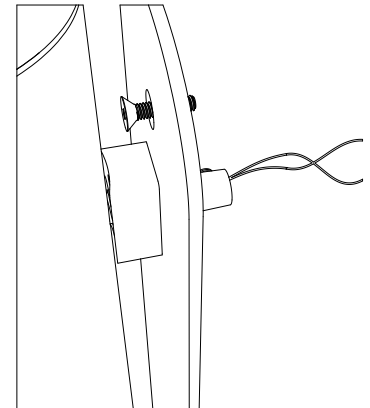
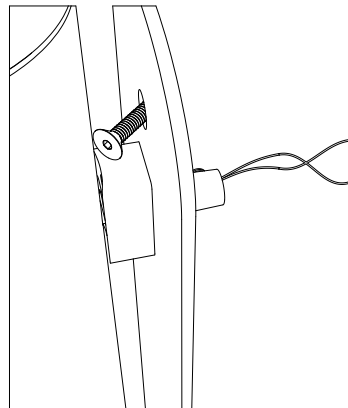
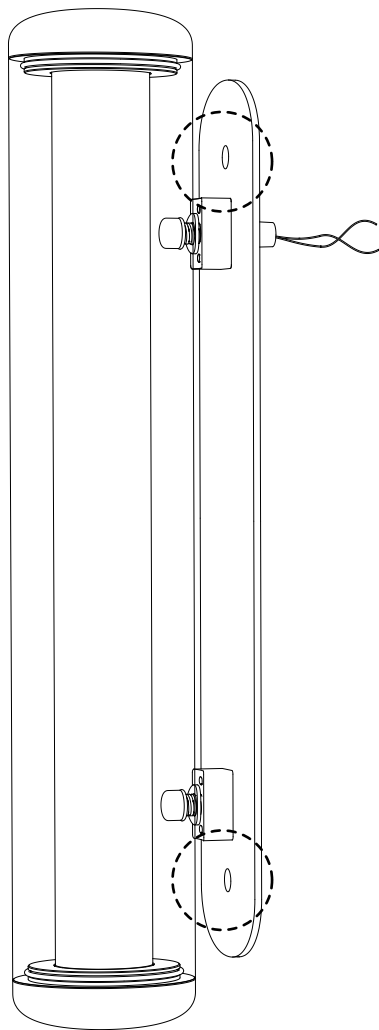

3. Thread hex screws through the backplate. Align these screws with the top mud ring hole and drywall anchor. Carefully tuck wired LED driver into JBox.

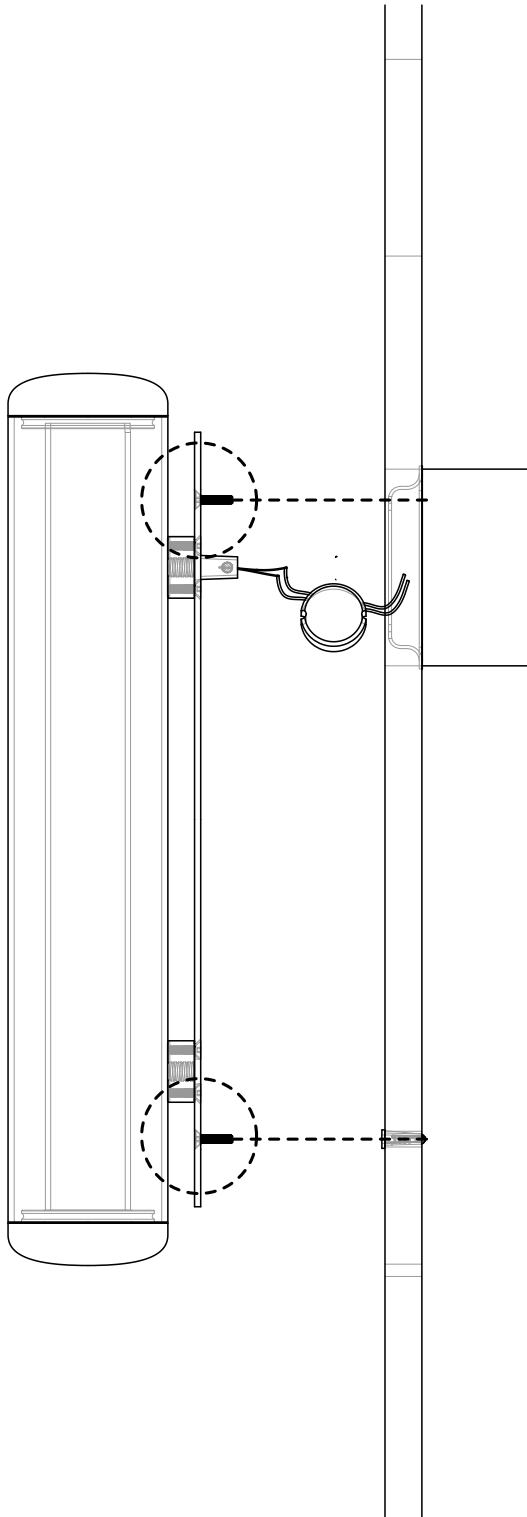

4. Using your fingers first to fit screws and then the provided stubby hex key, alternate tightening the two screws, threading each screw  $3/4$  turn at a time. Continue until sconce is tight against the wall.

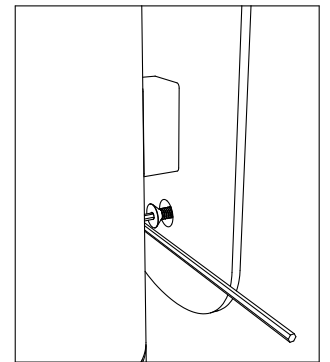
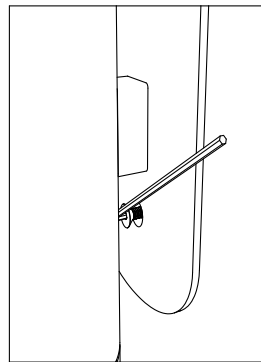

5. Return power to circuit, turn on your Henepin Made light(s) and enjoy.

