

Irrigation Filters

Specially designed for agricultural and irrigation applications. Suitable for any application where cool, filtered water is required. Standard units utilize an internal-to-external filter cartridge.

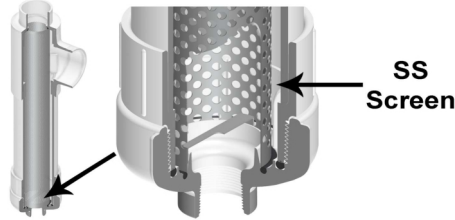

- 200 psi Working Pressure Non-Shock @ 73°F (23°C)
- Filter Body is made from NSF®-PW Approved PVC Material
- Optional Screen Meshes
- Compact Design, Easy to Clean
- Lightweight, Easy to Install
- Filter Screens are designed using a standard perforated Stainless Steel Screen
- Mesh Sizes include an inner Stainless Steel Cloth with Spring Support (external cloth on reverse flow filters)
- Pressure loss: 100 GPM – 3 psi 50 GPM – 1.25 psi
- May be pushed to required pipe size (Bushings sold separately)

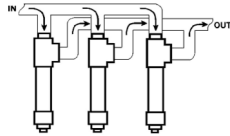

- When more than 100 gpm is required, filters may be installed in parallel
- When installing filter, allow space for removing filter screen for cleaning
- Remove stainless steel filter screen before solvent welding filter to pipe manifold
- When filters are installed in the direct sun, it is suggested the filter body be coated with a water-base latex paint having a high reflectance
- Installation in a shaded area is preferred

— CAUTION —

- WATER HAMMER MAY CAUSE SEVERE DAMAGE TO THE FILTER ASSEMBLY.
- BACK FLUSHING IS NOT RECOMMENDED.
- QUALITY GRADE THREAD SEALANT IS RECOMMENDED FOR ALL THREADED PVC CONNECTIONS.

Mesh Size	Hole Size (in.)	Part Number Extension
1/16" Holes	.0625	-16
1/32" Holes	.0312	-32
50 Mesh	.0117	-50
76 Mesh	.0095	-76
100 Mesh	.0059	-100
150 Mesh	.0041	-150
200 Mesh	.0029	-200

Additional Mesh Sizes available on request.

Series	A Inlet		B Outlet	C Overall Length	Screen Length
	Socket	Spigot			
FLR	2-1/2	3	4	28	24
MFLR	2-1/2	3	4	16	12

Part Number	Size	Std Pk	Mstr Ctn	Prod Code
-------------	------	--------	----------	-----------

Irrigation Filter Assembly 100 GPM with Stainless Steel Screen

100 GPM

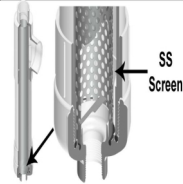

FL-16 ¹	2-1/2 3 x 4	1	0	020
FL-32 ¹	2-1/2 3 x 4	1	0	020
FL-50	2-1/2 3 x 4	1	0	020
FL-76	2-1/2 3 x 4	1	0	020
FL-100	2-1/2 3 x 4	1	0	020
FL-150	2-1/2 3 x 4	1	0	020
FL-200	2-1/2 3 x 4	1	0	020

¹ Standard FL-16 and FL-32 can be utilized as Reverse Flow Filters by reversing installation from current inlet to outlet and current outlet to inlet.

NOTE: Filter Assemblies are furnished standard with a 1-1/4" IPS tapped cap (FL-4A) for use with a valve, or may be plugged off (plug not furnished). Optional cap available with 1/4" IPS tapping for use with a pressure gauge — specify FL-5A when ordering.

Irrigation Filter Assembly 50 GPM with Stainless Steel Screen

50 GPM



MFL-16 ¹	2-1/2 3 x 2	1	0	020
MFL-32 ¹	2-1/2 3 x 2	1	0	020
MFL-50	2-1/2 3 x 2	1	0	020
MFL-76	2-1/2 3 x 2	1	0	020
MFL-100	2-1/2 3 x 2	1	0	020
MFL-150	2-1/2 3 x 2	1	0	020
MFL-200	2-1/2 3 x 2	1	0	020

¹ Standard MFL-16 and MFL-32 can be utilized as Reverse Flow Filters by reversing installation from current inlet to outlet and current outlet to inlet.

NOTE: Filter Assemblies are furnished standard with a 1-1/4" IPS tapped cap (FL4A) for use with a valve, or may be plugged off (plug not furnished). Optional cap available with 1/4" IPS tapping for use with a pressure gauge — specify FL-5A when ordering.

Irrigation Filter 100 GPM Replacement Screens

100 GPM (24" Length)

FL-16-1	1/16" Holes	4	0	020
FL-32-1	1/32" Holes	4	0	020
FL-50-1	50 Mesh	4	0	020
FL-76-1	76 Mesh	4	0	020
FL-100-1	100 Mesh	4	0	020
FL-150-1	150 Mesh	4	0	020
FL-200-1	200 Mesh	4	0	020

Suitable for Oil-Free air handling to 25 psi, not for distribution of compressed air or gas

JJ DOWNS INDUSTRIAL PLASTICS INC.

416.236.1884 Toronto, ON JJDOWN.COM

member
iapd
international association
of plastics distribution



Filters & Strainers Product
Strainers & Filters

Part Number	Size	Std Pk	Mstr Ctn	Prod Code
-------------	------	--------	----------	-----------

Irrigation Filter 100 GPM Replacement Screens (continued)
100 GPM (24" Length)

NOTE: When ordering replacement screens for FL and MFL Series Filters, please provide exact length of old screen within 1/64" to ensure proper fit of new screen in your filter body.

Irrigation Filter 50 GPM Replacement Screens

50 GPM (12" Length)



MFL-16-1	1/16" Holes	4	0	020
MFL-32-1	1/32" Holes	4	0	020
MFL-50-1	50 Mesh	4	0	020
MFL-76-1	76 Mesh	4	0	020
MFL-100-1	100 Mesh	4	0	020
MFL-150-1	150 Mesh	4	0	020
MFL-200-1	200 Mesh	4	0	020

NOTE: When ordering replacement screens for FL and MFL Series Filters, please provide exact length of old screen within 1/64" to ensure proper fit of new screen in your filter body.

Irrigation Filter 100 GPM Replacement Body

100 GPM Filter Body



FL-11	2-1/2 /3 X 4	1	0	020
-------	--------------	---	---	-----

Irrigation Filter 50 GPM Replacement Body

Part Number	Size	Std Pk	Mstr Ctn	Prod Code
-------------	------	--------	----------	-----------

50 GPM Filter Body

MFL-11	2-1/2 /3 X 2	1	0	020
--------	--------------	---	---	-----

Irrigation Filter Cap & O-ring for Old-Style w/3" Bottom Cap -1/4" outlet

FILTER CAP W/O-RING



Irrigation Filter Cap & O-ring for Old-Style w/3" Bottom Cap - 1-1/4" Outlet

Filter Cap w/Gasket



FL-4A	3X1-1/4	70	0	020
FL-5A	3X1/4	70	0	020

Irrigation Filter Cap Gasket for Old-Style w/3" Bottom Cap

Cap Gasket Only



FCG-5	3	2	0	020
-------	---	---	---	-----

Irrigation Filter New Style Body w/4" Bottom Cap & O-ring - 1/4" Outlet

FILTER CAP W/O-RING



Part Number	Size	Std Pk	Mstr Ctn	Prod Code
-------------	------	--------	----------	-----------

Irrigation Filter New Style Body w/4" Bottom Cap & O-ring - 1-1/4" Outlet



Filter Cap w/O-rings

FL-4B	4X1-1/4	25	0	020
FL-5B	4X1/4	1	0	020

Includes Cap with Cap O-ring (1) and bottom Filter Bushing O-ring (1)

Irrigation Filter Cap O-ring for New Style Body

Cap O-Ring Only



Pack of 5

FCB-5-986	---	1	20	891
-----------	-----	---	----	-----

Irrigation Filter Bushing O-ring for New Style Body

Filter Bushing O-Rings



B-335-60	---	1	0	901
----------	-----	---	---	-----

Each filter uses two (2) Filter Bushing O-rings for top and bottom screen seals

Suitable for Oil-Free air handling to 25 psi, not for distribution of compressed air or gas

JJ DOWNS INDUSTRIAL PLASTICS INC.

416.236.1884
Toronto, ON
JJDOWNS.COM



Filters & Strainers Product
Strainers & Filters



7 GPM Steel



7 GPM Plastic/Nylon

NOTE: It is recommended to connect the inlet of the Hose Filter to the system with a swivel adapter such as Spears® AP Series, to facilitate servicing of the filter element (refer to Hose Fittings).

Mesh Size	Hole Size (in.)	Part Number Extension
20 Mesh	.0331	-20
30 Mesh	.0232	-30
50 Mesh	.0117	-50
80 Mesh	.0070	-80
100 Mesh	.0059	-100
150 Mesh	.0041	-150
200 Mesh	.0029	-200

Additional Mesh Sizes available on request. Example: HF-50 = 50 Mesh

Part Number	Size	Std Pk	Mstr Ctn	Prod Code
-------------	------	--------	----------	-----------

Hose Filter Assembly with Stainless Steel Screen - 7 GPM

with **Stainless Steel Screen**

HF-20	3/4	10	60	020
HF-30	3/4	10	60	020
HF-50	3/4	10	60	020
HF-80	3/4	10	60	020
HF-100	3/4	10	60	020
HF-150	3/4	10	60	020
HF-200	3/4	10	60	020

Hose Filter Assembly with Plastic Nylon Screen - 7 GPM

with **Plastic/Nylon Screen**

HF-150N	3/4	10	60	020
---------	-----	----	----	-----

Hose Filter Stainless Steel Replacement Screen

Part Number	Size	Std Pk	Mstr Ctn	Prod Code
Stainless Steel Screen				
HF-20-1W	5	25	150	020

Hose Filter Stainless Steel Replacement Screen (continued)

Part Number	Size	Std Pk	Mstr Ctn	Prod Code
Stainless Steel Screen				
HF-30-1W	5	25	150	020
HF-50-1W	5	25	150	020
HF-80-1W	5	25	150	020
HF-100-1W	5	25	150	020
HF-150-1W	5	25	150	020
HF-200-1W	5	25	150	020

Hose Filter Plastic Nylon Replacement Screen

Part Number	Size	Std Pk	Mstr Ctn	Prod Code
Plastic/Nylon Screen				
HF-150-1NW	4-3/4	25	150	020

Hose Filter Body without Screen - 7 GPM

Hose Filter Body w/o screen



HF	3/4	10	60	020
----	-----	----	----	-----

Hose Filter Hose Washer- 7 GPM

Hose Washer



W-100	3/4	50	1500	020
-------	-----	----	------	-----

Hose Filter Screen Washer- 7 GPM

Screen Washer



S-W	---	600	0	891
-----	-----	-----	---	-----

Suitable for Oil-Free air handling to 25 psi, not for distribution of compressed air or gas

JJ DOWNS INDUSTRIAL PLASTICS INC.

416.236.1884
Toronto, ON
JJDOWNS.COM



Filters & Strainers Product
Strainers & Filters

100 GPM and 50 GPM • PVC White • Buna O-ring Seal

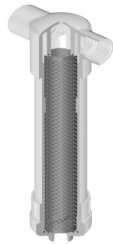

100 GPM



50 GPM

- In-line Design Simplifies Installation.
- Allows Easy Parallel Filter Configuration for Increased Flow and Filtration.
- Removable Type 304 Stainless Steel Filter Cartridges in Assorted Perforations and Screen Mesh.
- Standard Flow Filter (Internal-to-External) Traps Sediment on Inside of Cartridge, Reverse Flow Filter (External-to-Internal) Traps Sediment on Outside of Cartridge.
- Convenient Bottom Drain with 1-1/4" NPT Stainless Steel Reinforced Plastic Thread and Plug. Optional Cap with 1/4" Outlet Available.
- 200 psi Working Pressure for Water @ 73°F (23°C).
- Manufactured from NSF® Certified PVC Material.

Mesh Size	Hole Size (in.)	Part Number Extension
1/16" Holes	.0625	-16
1/32" Holes	.0312	-32
50 Mesh	.0117	-50
76 Mesh	.0095	-76
100 Mesh	.0059	-100
150 Mesh	.0041	-150
200 Mesh	.0029	-200

Additional Mesh Sizes available on request.
Example: TF-50 = 50 Mesh

Part Number	Size	Std Pk	Mstr Ctn	Prod Code
-------------	------	--------	----------	-----------

Irrigation Tee Filter - 100 GPM PVC White

Buna-N O-ring Seal with Stainless Steel Screen

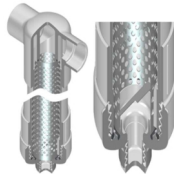

TF-16*	2-1/2 /3 x 2-1/2 /3	1	0	020
TF-32*	2-1/2 /3 x 2-1/2 /3	1	0	020
TF-50	2-1/2 /3 x 2-1/2 /3	1	0	020
TF-76	2-1/2 /3 x 2-1/2 /3	1	0	020
TF-100	2-1/2 /3 x 2-1/2 /3	1	0	020

Part Number	Size	Std Pk	Mstr Ctn	Prod Code
-------------	------	--------	----------	-----------

Irrigation Tee Filter - 100 GPM PVC White (continued)
Buna-N O-ring Seal with Stainless Steel Screen

TF-150	2-1/2 /3 x 2-1/2 /3	1	0	020
TF-200	2-1/2 /3 x 2-1/2 /3	1	0	020

Irrigation Tee Filter - 50 GPM PVC White

Buna-N O-ring Seal with Stainless Steel Screen

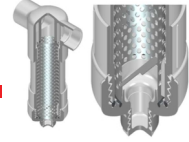

MTF-16*	2-1/2 /3 x 2-1/2 /3	1	0	020
MTF-32*	2-1/2 /3 x 2-1/2 /3	1	0	020
MTF-50	2-1/2 /3 x 2-1/2 /3	1	0	020
MTF-76	2-1/2 /3 x 2-1/2 /3	1	0	020
MTF-100	2-1/2 /3 x 2-1/2 /3	1	0	020
MTF-150	2-1/2 /3 x 2-1/2 /3	1	0	020
MTF-200	2-1/2 /3 x 2-1/2 /3	1	0	020

Irrigation Reverse Flow Tee Filter - 100 GPM PVC White

Part Number	Size	Std Pk	Mstr Ctn	Prod Code
-------------	------	--------	----------	-----------

Buna-N O-ring Seal with Stainless Steel Screen

TF-16*	2-1/2 /3 x 2-1/2 /3	1	0	020
TF-32*	2-1/2 /3 x 2-1/2 /3	1	0	020
TFR-50	2-1/2 /3 x 2-1/2 /3	1	0	020
TFR-76	2-1/2 /3 x 2-1/2 /3	1	0	020
TFR-100	2-1/2 /3 x 2-1/2 /3	1	0	020
TFR-150	2-1/2 /3 x 2-1/2 /3	1	0	020
TFR-200	2-1/2 /3 x 2-1/2 /3	1	0	020

Irrigation Reverse Flow Tee Filter - 50 GPM PVC White

Buna-N O-ring Seal with Stainless Steel Screen

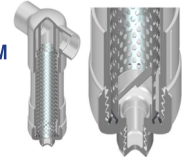

MTF-16*	2-1/2 /3 x 2-1/2 /3	1	0	020
MTF-32*	2-1/2 /3 x 2-1/2 /3	1	0	020
MTFR-50	2-1/2 /3 x 2-1/2 /3	1	0	020
MTFR-76	2-1/2 /3 x 2-1/2 /3	1	0	020
MTFR-100	2-1/2 /3 x 2-1/2 /3	1	0	020
MTFR-150	2-1/2 /3 x 2-1/2 /3	1	0	020
MTFR-200	2-1/2 /3 x 2-1/2 /3	1	0	020

*Standard TF-16, TF-32, MTF-16 & MTF-32 can be utilized as Reverse Flow Filters by reversing installation from current inlet to outlet and current outlet to inlet.

Irrigation Reverse Flow Tee Filter - 100 GPM Replacement Screens for TF Filters (24" Length)

FL-16-1	1/16" Holes	4	0	020
---------	-------------	---	---	-----

Made in the U.S.A.

Suitable for Oil-Free air handling to 25 psi, not for distribution of compressed air or gas
See MSRP-1 Sheet or Check Spears® On-line Catalog @ www.spearsmfg.com for Pricing

Suitable for Oil-Free air handling to 25 psi, not for distribution of compressed air or gas

JJ DOWNS INDUSTRIAL PLASTICS INC.

416.236.1884
Toronto, ON
JJDOWNS.COM

member
iapd
international association
of plastics distributors



Filters & Strainers Product
Strainers & Filters

Part Number	Size	Std Pk	Mstr Ctn	Prod Code
Irrigation Reverse Flow Tee Filter - 100 GPM Replacement Screens for TF Filters (24" Length) (continued)				
FL-32-1	1/32" Holes	4	0	020
FL-50-1	50 Mesh	4	0	020
FL-76-1	76 Mesh	4	0	020
FL-100-1	100 Mesh	4	0	020
FL-150-1	150 Mesh	4	0	020
FL-200-1	200 Mesh	4	0	020

NOTE: When ordering replacement screens for TF and MTF Series Filters, please provide exact length of old screen within 1/64" to insure proper fit of new screen in your filter body.

Irrigation Reverse Flow Tee Filter - 50 GPM Filter Replacement Screens for MTF Filters (12" Length)



MFL-16-1	1/16" Holes	4	0	020
MFL-32-1	1/32" Holes	4	0	020
MFL-50-1	50 Mesh	4	0	020
MFL-76-1	76 Mesh	4	0	020
MFL-100-1	100 Mesh	4	0	020
MFL-150-1	150 Mesh	4	0	020
MFL-200-1	200 Mesh	4	0	020

NOTE: When ordering replacement screens for TF and MTF Series Filters, please provide exact length of old screen within 1/64" to insure proper fit of new screen in your filter body.

Irrigation Reverse Flow Tee Filter - 100 GPM Replacement Screens for TFR Filters(24" Length)



FL-16-1	1/16" Holes	4	0	020
FL-32-1	1/32" Holes	4	0	020
FLR-50-1	50 Mesh	4	0	020
FLR-76-1	76 Mesh	4	0	020
FLR-100-1	100 Mesh	4	0	020
FLR-150-1	150 Mesh	4	0	020
FLR-200-1	200 Mesh	4	0	020

Irrigation Reverse Flow Tee Filter - 50 GPM Replacement Screens for MTFR Filters (12" Length)



MFL-16-1	1/16" Holes	4	0	020
MFL-32-1	1/32" Holes	4	0	020
MFLR-50-1	50 Mesh	4	0	020
MFLR-76-1	76 Mesh	4	0	020
MFLR-100-1	100 Mesh	4	0	020
MFLR-150-1	150 Mesh	4	0	020
MFLR-200-1	200 Mesh	4	0	020



100 GPM



50 GPM

- Filter cartridge specially designed for external-to-internal filtration
- Traps sediment and debris on outside of filter (standard filters use internal-to-external flow)
- 100 GPM and 50 GPM styles available

Irrigation Reverse Flow Filter with Stainless Steel Screen - 100 GPM

Part Number	Size	Std Pk	Mstr Ctn	Prod Code
Socket x Socket/Spigot				
FLR-16 ¹	4X2-1/2 /3	1	0	020
FLR-32 ¹	4X2-1/2 /3	1	0	020
FLR-50	4X2-1/2 /3	1	0	020
FLR-76	4X2-1/2 /3	1	0	020
FLR-100	4X2-1/2 /3	1	0	020
FLR-150	4X2-1/2 /3	1	0	020
FLR-200	4X2-1/2 /3	1	0	020

¹ Standard FL-16 and FL-32 can be utilized as Reverse Flow Filters by reversing installation from current inlet to outlet and current outlet to inlet.

Irrigation Reverse Flow Filter with Stainless Steel Screen - 50 GPM

Part Number	Size	Std Pk	Mstr Ctn	Prod Code
Socket x Socket/Spigot				
MFLR-16 ¹	2X2-1/2 /3	1	0	020
MFLR-32 ¹	2X2-1/2 /3	1	0	020
MFLR-50	2X2-1/2 /3	1	0	020
MFLR-76	2X2-1/2 /3	1	0	020
MFLR-100	2X2-1/2 /3	1	0	020
MFLR-150	2X2-1/2 /3	1	0	020
MFLR-200	2X2-1/2 /3	1	0	020

¹ Standard MFL-16 and MFL-32 can be utilized as Reverse Flow Filters by reversing installation from current inlet to outlet and current outlet to inlet.

Irrigation Filter Reverse Flow SS Replacement Screens (24" Length)

100 GPM



FL-16-1	1/16" Holes	4	0	020
FL-32-1	1/32" Holes	4	0	020
FLR-50-1	50 Mesh	4	0	020
FLR-76-1	76 Mesh	4	0	020
FLR-100-1	100 Mesh	4	0	020
FLR-150-1	150 Mesh	4	0	020
FLR-200-1	200 Mesh	4	0	020

Suitable for Oil-Free air handling to 25 psi, not for distribution of compressed air or gas

JJ DOWNS INDUSTRIAL PLASTICS INC.

416.236.1884
Toronto, ON
JJDOWNS.COM



Filters & Strainers Product
Strainers & Filters

Part Number	Size	Std Pk	Mstr Ctn	Prod Code	
Irrigation Filter Reverse Flow SS Replacement Screens (12" Length)					
50 GPM					
MFL-16-1	1/16" Holes	4	0	020	
MFL-32-1	1/32" Holes	4	0	020	
MFLR-50-1	50 Mesh	4	0	020	
MFLR-76-1	76 Mesh	4	0	020	
MFLR-100-1	100 Mesh	4	0	020	
MFLR-150-1	150 Mesh	4	0	020	
MFLR-200-1	200 Mesh	4 </td <td>0</td> <td>020</td>	0	020	
Size	EPDM	FKM	Std Pk	Mstr Pk	Prod Code

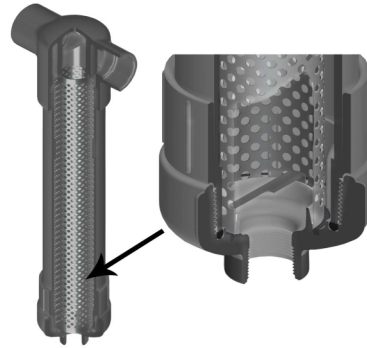

Socket/Spigot

All Filters are 2-1/2" x 2-1/2" Inlet/Outlet Connection

Note: 2-1/2" Socket is also a 3" Spigot

Pressure Rating @ 73°F (23°C), Water
200 psi

Mesh Size Codes

Mesh Size	Size Code
1/16" Holes	16
1/32" Holes	32
50 Mesh	50
76 Mesh	76
100 Mesh	100
150 Mesh	150
200 Mesh	200

Industrial Tee Filter - 100 GPM PVC Gray

Stainless Steel Screen

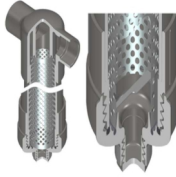

16	TF2-16	TF3-16	1	0	295
32	TF2-32	TF3-32	1	0	295
50	TF2-50	TF3-50	1	0	295
76	TF2-76	TF3-76	1	0	295
100	TF2-100	TF3-100	1	0	295
150	TF2-150	TF3-150	1	0	295
200	TF2-200	TF3-200	1	0	295

Standard TF2-16, TF2-32, TF3-16, TF3-32, MTF2-16, MTF2-32, MTF3-16 & MTF3-32 can be utilized as Reverse Flow Filters by reversing installation from current inlet to outlet and current outlet to inlet.

Industrial Tee Filter - 50 GPM PVC Gray

Stainless Steel Screen

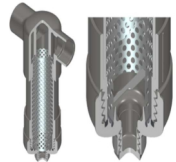

16	MTF2-16	MTF3-16	1	0	295
32	MTF2-32	MTF3-32	1	0	295
50	MTF2-50	MTF3-50	1	0	295
76	MTF2-76	MTF3-76	1	0	295
100	MTF2-100	MTF3-100	1	0	295
150	MTF2-150	MTF3-150	1	0	295
200	MTF2-200	MTF3-200	1	0	295

Standard TF2-16, TF2-32, TF3-16, TF3-32, MTF2-16, MTF2-32, MTF3-16 & MTF3-32 can be utilized as Reverse Flow Filters by reversing installation from current inlet to outlet and current outlet to inlet.

Note: Standard flow filtration path is internal to external. Reverse-flow filtration flows from external to internal side of filter screen.

Industrial Reverse Flow Tee Filter - 100 GPM PVC Gray

Size	EPDM	FKM	Std Pk	Mstr Pk	Prod Code
Stainless Steel Screen					
16	TF2-16	TF3-16	1	0	295
32	TF2-32	TF3-32	1	0	295
50	TFR2-50	TFR3-50	1	0	295
76	TFR2-76	TFR3-76	1	0	295

Suitable for Oil-Free air handling to 25 psi, not for distribution of compressed air or gas

JJ DOWNS INDUSTRIAL PLASTICS INC.

416.236.1884
Toronto, ON
JJDOWNS.COM

international association of plastics distributors



Filters & Strainers Product
Strainers & Filters

Industrial Reverse Flow Tee Filter - 100 GPM PVC Gray (continued)

Size	EPDM	FKM	Std Pk	Mstr Pk	Prod Code
------	------	-----	--------	---------	-----------

Stainless Steel Screen

100	TFR2-100	TFR3-100	1	0	295
150	TFR2-150	TFR3-150	1	0	295
200	TFR2-200	TFR3-200	1	0	295

Standard TF2-16, TF2-32, TF3-16, TF3-32, MTF2-16, MTF2-32, MTF3-16 & MTF3-32 can be utilized as Reverse Flow Filters by reversing installation from current inlet to outlet and current outlet to inlet.

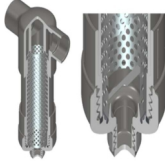

Industrial Reverse Flow Tee Filter - 50 GPM PVC Gray

Stainless Steel Screen

16	MTF2-16	MTF3-16	1	0	295
32	MTF2-32	MTF3-32	1	0	295
50	MTFR2-50	MTFR3-50	1	0	295
76	MTFR2-76	MTFR3-76	1	0	295
100	MTFR2-100	MTFR3-100	1	0	295
150	MTFR2-150	MTFR3-150	1	0	295
200	MTFR2-200	MTFR3-200	1	0	295

Standard TF2-16, TF2-32, TF3-16, TF3-32, MTF2-16, MTF2-32, MTF3-16 & MTF3-32 can be utilized as Reverse Flow Filters by reversing installation from current inlet to outlet and current outlet to inlet.

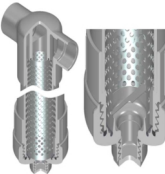

Industrial Tee Filter - 100 GPM CPVC

Stainless Steel Screen

16	TF2-16C	TF3-16C	1	0	296
32	TF2-32C	TF3-32C	1	0	296
50	TF2-50C	TF3-50C	1	0	296
76	TF2-76C	TF3-76C	1	0	296
100	TF2-100C	TF3-100C	1	0	296
150	TF2-150C	TF3-150C	1	0	296
200	TF2-200C	TF3-200C	1	0	296

Standard TF2-16C, TF2-32C, TF3-16C, TF3-32C, MTF2-16C, MTF2-32C, MTF3-16C & MTF3-32C can be utilized as Reverse Flow Filters by reversing installation from current inlet to outlet and current outlet to inlet.

Size	EPDM	FKM	Std Pk	Mstr Pk	Prod Code
------	------	-----	--------	---------	-----------

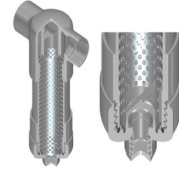

Industrial Tee Filter - 50 GPM CPVC

Stainless Steel Screen

16	MTF2-16C	MTF3-16C	1	0	296
32	MTF2-32C	MTF3-32C	1	0	296
50	MTF2-50C	MTF3-50C	1	0	296
76	MTF2-76C	MTF3-76C	1	0	296
100	MTF2-100C	MTF3-100C	1	0	296
150	MTF2-150C	MTF3-150C	1	0	296
200	MTF2-200C	MTF3-200C	1	0	296

Standard TF2-16C, TF2-32C, TF3-16C, TF3-32C, MTF2-16C, MTF2-32C, MTF3-16C & MTF3-32C can be utilized as Reverse Flow Filters by reversing installation from current inlet to outlet and current outlet to inlet.

Industrial Reverse Flow Tee Filter - 100 GPM CPVC

Size	EPDM	FKM	Std Pk	Mstr Pk	Prod Code
------	------	-----	--------	---------	-----------

Stainless Steel Screen

16	TF2-16C	TF3-16C	1	0	296
32	TF2-32C	TF3-32C	1	0	296
50	TFR2-50C	TFR3-50C	1	0	296
76	TFR2-76C	TFR3-76C	1	0	296
100	TFR2-100C	TFR3-100C	1	0	296
150	TFR2-150C	TFR3-150C	1	0	296
200	TFR2-200C	TFR3-200C	1	0	296

Standard TF2-16C, TF2-32C, TF3-16C, TF3-32C, MTF2-16C, MTF2-32C, MTF3-16C & MTF3-32C can be utilized as Reverse Flow Filters by reversing installation from current inlet to outlet and current outlet to inlet.

Industrial Reverse Flow Tee Filter - 50 GPM CPVC

Size	EPDM	FKM	Std Pk	Mstr Pk	Prod Code
------	------	-----	--------	---------	-----------

Stainless Steel Screen

16	MTF2-16C	MTF3-16C	1	0	296
32	MTF2-32C	MTF3-32C	1	0	296
50	MTFR2-50C	MTFR3-50C	1	0	296
76	MTFR2-76C	MTFR3-76C	1	0	296
100	MTFR2-100C	MTFR3-100C	1	0	296
150	MTFR2-150C	MTFR3-150C	1	0	296
200	MTFR2-200C	MTFR3-200C	1	0	296

Standard TF2-16C, TF2-32C, TF3-16C, TF3-32C, MTF2-16C, MTF2-32C, MTF3-16C & MTF3-32C can be utilized as Reverse Flow Filters by reversing installation from current inlet to outlet and current outlet to inlet.

Part Number	Size	Std Pk	Mstr Ctn	Prod Code
-------------	------	--------	----------	-----------

Industrial Tee Filter Replacement Screens for TF Filters -100 GPM



FL-16-1	1/16" Holes	4	0	020
FL-32-1	1/32" Holes	4	0	020
FL-50-1	50 Mesh	4	0	020

Suitable for Oil-Free air handling to 25 psi, not for distribution of compressed air or gas

JJ DOWNS INDUSTRIAL PLASTICS INC.

416.236.1884
Toronto, ON
JJDOWNS.COM



Filters & Strainers Product
Strainers & Filters

Part Number	Size	Std Pk	Mstr Ctn	Prod Code
Industrial Tee Filter Replacement Screens for TF Filters -100 GPM (continued)				
FL-76-1	76 Mesh	4	0	020
FL-100-1	100 Mesh	4	0	020
FL-150-1	150 Mesh	4	0	020
FL-200-1	200 Mesh	4	0	020

NOTE: When ordering replacement screens for TF Series Filters, please provide exact length of old screen within 1/64" to insure proper fit of new screen in your filter body.

Industrial Tee Filter Replacement Screens for MTF Filters - 50 GPM



MFL-16-1	1/16" Holes	4	0	020
MFL-32-1	1/32" Holes	4	0	020
MFL-50-1	50 Mesh	4	0	020
MFL-76-1	76 Mesh	4	0	020
MFL-100-1	100 Mesh	4	0	020
MFL-150-1	150 Mesh	4	0	020
MFL-200-1	200 Mesh	4	0	020

NOTE: When ordering replacement screens for MTF Series Filters, please provide exact length of old screen within 1/64" to insure proper fit of new screen in your filter body.

Industrial Reverse Flow Tee Filter Replacement Screens for TFR Filters - 100 GPM



FL-16-1	1/16" Holes	4	0	020
FL-32-1	1/32" Holes	4	0	020
FLR-50-1	50 Mesh	4	0	020
FLR-76-1	76 Mesh	4	0	020
FLR-100-1	100 Mesh	4	0	020
FLR-150-1	150 Mesh	4	0	020
FLR-200-1	200 Mesh	4	0	020

Industrial Reverse Flow Tee Filter Replacement Screens for MTFR Filters - 50 GPM



MFL-16-1	1/16" Holes	4	0	020
MFL-32-1	1/32" Holes	4	0	020
MFLR-50-1	50 Mesh	4	0	020
MFLR-76-1	76 Mesh	4	0	020
MFLR-100-1	100 Mesh	4	0	020
MFLR-150-1	150 Mesh	4	0	020
MFLR-200-1	200 Mesh	4	0	020

Suitable for Oil-Free air handling to 25 psi, not for distribution of compressed air or gas

JJD	 <small>member international association of plastics distribution</small>
JJ DOWNS INDUSTRIAL PLASTICS INC.	
416.236.1884	Toronto, ON
JJDOWNNS.COM	



Filters & Strainers Product
Strainers & Filters

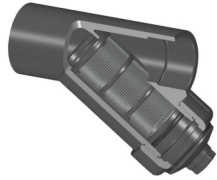

Socket



Flanged

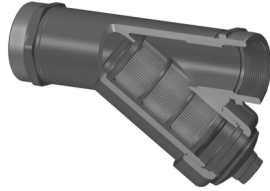

SR Thread

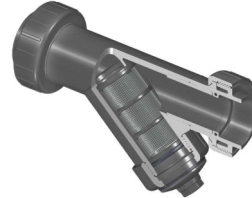

True Union

Part numbers shown reflect a mesh size of 8. For different mesh sizes, substitute Mesh Code in part number as specified in chart below.

U.S. Standard Mesh Sieve No.	Sieve Opening Size (in.)	Part Number Mesh Code
8	0.094	8
12	0.062	12
20	0.033	20
30	0.024	30

Example: for 12 Mesh, specify YS22P12-005

Additional Mesh Sizes available on request.

Pressure Rating @ 73°F (23°C), Water
 1/2" - 2" 150 psi
 3" - 4" 90 psi

Maximum Service Temperature
 PVC = 140°F (60°C)
 CPVC = 200°F (93°C)

Temperature/Pressure De-ratings Apply

Size	EPDM Seals PVC Screen	EPDM Seals SS Screen	FKM Seals PVC Screen	FKM Seals SS Screen	Std Pk	Mstr Pk	Prod Code
------	-----------------------	----------------------	----------------------	---------------------	--------	---------	-----------



Y-Strainer PVC - Socket Ends

Size	YS22P8-005	YS22S8-005	YS32P8-005	YS32S8-005	1	18	102
3/4	YS22P8-007	YS22S8-007	YS32P8-007	YS32S8-007	1	18	102
1	YS22P8-010	YS22S8-010	YS32P8-010	YS32S8-010	1	12	102
1-1/4	YS22P8-012	YS22S8-012	YS32P8-012	YS32S8-012	1	8	102
1-1/2	YS22P8-015	YS22S8-015	YS32P8-015	YS32S8-015	1	8	102
2	YS22P8-020	YS22S8-020	YS32P8-020	YS32S8-020	1	4	102
3	YS22P8-030	YS22S8-030	YS32P8-030	YS32S8-030	1	0	102
4	YS22P8-040	YS22S8-040	YS32P8-040	YS32S8-040	1	0	102

Suitable for Oil-Free air handling to 25 psi, not for distribution of compressed air or gas

JJ DOWNS INDUSTRIAL PLASTICS INC.

416.236.1884
Toronto, ON
JJDOWNS.COM



Filters & Strainers Product
Strainers & Filters

Size	EPDM Seals PVC Screen	EPDM Seals SS Screen	FKM Seals PVC Screen	FKM Seals SS Screen	Std Pk	Mstr Pk	Prod Code
------	-----------------------	----------------------	----------------------	---------------------	--------	---------	-----------



Y-Strainer PVC - SR Threaded Ends

1/2	YS21P8-005SR	YS21S8-005SR	YS31P8-005SR	YS31S8-005SR	1	18	102
3/4	YS21P8-007SR	YS21S8-007SR	YS31P8-007SR	YS31S8-007SR	1	12	102
1	YS21P8-010SR	YS21S8-010SR	YS31P8-010SR	YS31S8-010SR	1	8	102
1-1/4	YS21P8-012SR	YS21S8-012SR	YS31P8-012SR	YS31S8-012SR	1	8	102
1-1/2	YS21P8-015SR	YS21S8-015SR	YS31P8-015SR	YS31S8-015SR	1	4	102
2	YS21P8-020SR	YS21S8-020SR	YS31P8-020SR	YS31S8-020SR	1	0	102
3	YS21P8-030SR	YS21S8-030SR	YS31P8-030SR	YS31S8-030SR	1	0	102
4	YS21P8-040SR	YS21S8-040SR	YS31P8-040SR	YS31S8-040SR	1	0	102

Size	EPDM Seals PVC Screen	EPDM Seals SS Screen	FKM Seals PVC Screen	FKM Seals SS Screen	Std Pk	Mstr Pk	Prod Code
------	-----------------------	----------------------	----------------------	---------------------	--------	---------	-----------

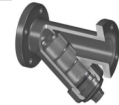

Y-Strainer PVC - Flanged Ends

1/2	YS23P8-005	YS23S8-005	YS33P8-005	YS33S8-005	1	8	102
3/4	YS23P8-007	YS23S8-007	YS33P8-007	YS33S8-007	1	8	102
1	YS23P8-010	YS23S8-010	YS33P8-010	YS33S8-010	1	8	102
1-1/4	YS23P8-012	YS23S8-012	YS33P8-012	YS33S8-012	1	4	102
1-1/2	YS23P8-015	YS23S8-015	YS33P8-015	YS33S8-015	1	4	102
2	YS23P8-020	YS23S8-020	YS33P8-020	YS33S8-020	1	0	102
3	YS23P8-030	YS23S8-030	YS33P8-030	YS33S8-030	1	0	102
4	YS23P8-040	YS23S8-040	YS33P8-040	YS33S8-040	1	0	102

Size	EPDM Seals PVC Screen	EPDM Seals SS Screen	FKM Seals PVC Screen	FKM Seals SS Screen	Std Pk	Mstr Pk	Prod Code
------	-----------------------	----------------------	----------------------	---------------------	--------	---------	-----------



Y-Strainer PVC Clear - Socket Ends

1/2	YS22P8-005CL	YS22S8-005CL	YS32P8-005CL	YS32S8-005CL	1	18	103
3/4	YS22P8-007CL	YS22S8-007CL	YS32P8-007CL	YS32S8-007CL	1	18	103
1	YS22P8-010CL	YS22S8-010CL	YS32P8-010CL	YS32S8-010CL	1	12	103
1-1/4	YS22P8-012CL	YS22S8-012CL	YS32P8-012CL	YS32S8-012CL	1	8	103
1-1/2	YS22P8-015CL	YS22S8-015CL	YS32P8-015CL	YS32S8-015CL	1	8	103
2	YS22P8-020CL	YS22S8-020CL	YS32P8-020CL	YS32S8-020CL	1	4	103
3	YS22P8-030CL	YS22S8-030CL	YS32P8-030CL	YS32S8-030CL	1	0	103
4	YS22P8-040CL	YS22S8-040CL	YS32P8-040CL	YS32S8-040CL	1	0	103

Suitable for Oil-Free air handling to 25 psi, not for distribution of compressed air or gas

JJD	 member iapd <small>international association of plastics distribution</small>
JJ DOWNS INDUSTRIAL PLASTICS INC.	
416.236.1884	Toronto, ON
JJDOWN.COM	



Filters & Strainers Product
Strainers & Filters

Size	EPDM Seals PVC Screen	EPDM Seals SS Screen	FKM Seals PVC Screen	FKM Seals SS Screen	Std Pk	Mstr Pk	Prod Code
------	-----------------------	----------------------	----------------------	---------------------	--------	---------	-----------



Y-Strainer PVC Clear - SR Threaded Ends

1/2	YS21P8-005CLSR	YS21S8-005CLSR	YS31P8-005CLSR	YS31S8-005CLSR	1	18	103
3/4	YS21P8-007CLSR	YS21S8-007CLSR	YS31P8-007CLSR	YS31S8-007CLSR	1	12	103
1	YS21P8-010CLSR	YS21S8-010CLSR	YS31P8-010CLSR	YS31S8-010CLSR	1	8	103
1-1/4	YS21P8-012CLSR	YS21S8-012CLSR	YS31P8-012CLSR	YS31S8-012CLSR	1	8	103
1-1/2	YS21P8-015CLSR	YS21S8-015CLSR	YS31P8-015CLSR	YS31S8-015CLSR	1	4	103
2	YS21P8-020CLSR	YS21S8-020CLSR	YS31P8-020CLSR	YS31S8-020CLSR	1	0	103
3	YS21P8-030CLSR	YS21S8-030CLSR	YS31P8-030CLSR	YS31S8-030CLSR	1	0	103
4	YS21P8-040CLSR	YS21S8-040CLSR	YS31P8-040CLSR	YS31S8-040CLSR	1	0	103

Size	EPDM Seals PVC Screen	EPDM Seals SS Screen	FKM Seals PVC Screen	FKM Seals SS Screen	Std Pk	Mstr Pk	Prod Code
------	-----------------------	----------------------	----------------------	---------------------	--------	---------	-----------



Y-Strainer PVC Clear - Flanged Ends

1/2	YS23P8-005CL	YS23S8-005CL	YS33P8-005CL	YS33S8-005CL	1	8	103
3/4	YS23P8-007CL	YS23S8-007CL	YS33P8-007CL	YS33S8-007CL	1	8	103
1	YS23P8-010CL	YS23S8-010CL	YS33P8-010CL	YS33S8-010CL	1	8	103
1-1/4	YS23P8-012CL	YS23S8-012CL	YS33P8-012CL	YS33S8-012CL	1	4	103
1-1/2	YS23P8-015CL	YS23S8-015CL	YS33P8-015CL	YS33S8-015CL	1	4	103
2	YS23P8-020CL	YS23S8-020CL	YS33P8-020CL	YS33S8-020CL	1	0	103
3	YS23P8-030CL	YS23S8-030CL	YS33P8-030CL	YS33S8-030CL	1	0	103
4	YS23P8-040CL	YS23S8-040CL	YS33P8-040CL	YS33S8-040CL	1	0	103

Size	EPDM Seals CPVC Screen	EPDM Seals SS Screen	FKM Seals CPVC Screen	FKM Seals SS Screen	Std Pk	Mstr Pk	Prod Code
------	------------------------	----------------------	-----------------------	---------------------	--------	---------	-----------



Y-Strainer CPVC - Socket Ends

1/2	YS22C8-005C	YS22S8-005C	YS32C8-005C	YS32S8-005C	1	18	104
3/4	YS22C8-007C	YS22S8-007C	YS32C8-007C	YS32S8-007C	1	18	104
1	YS22C8-010C	YS22S8-010C	YS32C8-010C	YS32S8-010C	1	12	104
1-1/4	YS22C8-012C	YS22S8-012C	YS32C8-012C	YS32S8-012C	1	8	104
1-1/2	YS22C8-015C	YS22S8-015C	YS32C8-015C	YS32S8-015C	1	8	104
2	YS22C8-020C	YS22S8-020C	YS32C8-020C	YS32S8-020C	1	4	104
3	YS22C8-030C	YS22S8-030C	YS32C8-030C	YS32S8-030C	1	0	104
4	YS22C8-040C	YS22S8-040C	YS32C8-040C	YS32S8-040C	1	0	104

Suitable for Oil-Free air handling to 25 psi, not for distribution of compressed air or gas

JJD	 member iapd <small>international association of plastics distribution</small>	
JJ DOWNS INDUSTRIAL PLASTICS INC.		
416.236.1884	Toronto, ON	JJDOWN.COM



Filters & Strainers Product
Strainers & Filters

Size	EPDM Seals CPVC Screen	EPDM Seals SS Screen	FKM Seals CPVC Screen	FKM Seals SS Screen	Std Pk	Mstr Pk	Prod Code
------	------------------------	----------------------	-----------------------	---------------------	--------	---------	-----------



Y-Strainer CPVC - SR Threaded Ends

1/2	YS21C8-005CSR	YS21S8-005CSR	YS31C8-005CSR	YS31S8-005CSR	1	18	104
3/4	YS21C8-007CSR	YS21S8-007CSR	YS31C8-007CSR	YS31S8-007CSR	1	12	104
1	YS21C8-010CSR	YS21S8-010CSR	YS31C8-010CSR	YS31S8-010CSR	1	8	104
1-1/4	YS21C8-012CSR	YS21S8-012CSR	YS31C8-012CSR	YS31S8-012CSR	1	8	104
1-1/2	YS21C8-015CSR	YS21S8-015CSR	YS31C8-015CSR	YS31S8-015CSR	1	4	104
2	YS21C8-020CSR	YS21S8-020CSR	YS31C8-020CSR	YS31S8-020CSR	1	0	104
3	YS21C8-030CSR	YS21S8-030CSR	YS31C8-030CSR	YS31S8-030CSR	1	0	104
4	YS21C8-040CSR	YS21S8-040CSR	YS31C8-040CSR	YS31S8-040CSR	1	0	104

Size	EPDM Seals CPVC Screen	EPDM Seals SS Screen	FKM Seals CPVC Screen	FKM Seals SS Screen	Std Pk	Mstr Pk	Prod Code
------	------------------------	----------------------	-----------------------	---------------------	--------	---------	-----------



Y-Strainer CPVC - Flanged Ends

1/2	YS23C8-005C	YS23S8-005C	YS33C8-005C	YS33S8-005C	1	8	104
3/4	YS23C8-007C	YS23S8-007C	YS33C8-007C	YS33S8-007C	1	8	104
1	YS23C8-010C	YS23S8-010C	YS33C8-010C	YS33S8-010C	1	8	104
1-1/4	YS23C8-012C	YS23S8-012C	YS33C8-012C	YS33S8-012C	1	4	104
1-1/2	YS23C8-015C	YS23S8-015C	YS33C8-015C	YS33S8-015C	1	4	104
2	YS23C8-020C	YS23S8-020C	YS33C8-020C	YS33S8-020C	1	0	104
3	YS23C8-030C	YS23S8-030C	YS33C8-030C	YS33S8-030C	1	0	104
4	YS23C8-040C	YS23S8-040C	YS33C8-040C	YS33S8-040C	1	0	104

Size	EPDM PVC Screen	EPDM SS Screen	FKM PVC Screen	FKM SS Screen	Std Pk	Mstr Pk	Prod Code
------	-----------------	----------------	----------------	---------------	--------	---------	-----------



True Union Socket Ends - PVC Gray

1/2	YS2AP8-005	YS2AS8-005	YS3AP8-005	YS3AS8-005	1	12	102
3/4	YS2AP8-007	YS2AS8-007	YS3AP8-007	YS3AS8-007	1	8	102
1	YS2AP8-010	YS2AS8-010	YS3AP8-010	YS3AS8-010	1	8	102
1-1/4	YS2AP8-012	YS2AS8-012	YS3AP8-012	YS3AS8-012	1	4	102
1-1/2	YS2AP8-015	YS2AS8-015	YS3AP8-015	YS3AS8-015	1	0	102
2	YS2AP8-020	YS2AS8-020	YS3AP8-020	YS3AS8-020	1	0	102
3	YS2AP8-030	YS2AS8-030	YS3AP8-030	YS3AS8-030	1	0	102
4	YS2AP8-040	YS2AS8-040	YS3AP8-040	YS3AS8-040	1	0	102

Suitable for Oil-Free air handling to 25 psi, not for distribution of compressed air or gas

JJD	 <small>member</small> iapd <small>international association of plastics distribution</small>
JJ DOWNS INDUSTRIAL PLASTICS INC.	
416.236.1884	Toronto, ON
JJDOWN.COM	



Filters & Strainers Product
Strainers & Filters

Size	EPDM PVC Screen	EPDM SS Screen	FKM PVC Screen	FKM SS Screen	Std Pk	Mstr Pk	Prod Code
------	-----------------	----------------	----------------	---------------	--------	---------	-----------



True Union Threaded Ends - PVC Gray

1/2	YS2BP8-005	YS2BS8-005	YS3BP8-005	YS3BS8-005	1	12	102
3/4	YS2BP8-007	YS2BS8-007	YS3BP8-007	YS3BS8-007	1	8	102
1	YS2BP8-010	YS2BS8-010	YS3BP8-010	YS3BS8-010	1	8	102
1-1/4	YS2BP8-012	YS2BS8-012	YS3BP8-012	YS3BS8-012	1	4	102
1-1/2	YS2BP8-015	YS2BS8-015	YS3BP8-015	YS3BS8-015	1	0	102
2	YS2BP8-020	YS2BS8-020	YS3BP8-020	YS3BS8-020	1	0	102
3	YS2BP8-030	YS2BS8-030	YS3BP8-030	YS3BS8-030	1	0	102
4	YS2BP8-040	YS2BS8-040	YS3BP8-040	YS3BS8-040	1	0	102

Size	EPDM PVC Screen	EPDM SS Screen	FKM PVC Screen	FKM SS Screen	Std Pk	Mstr Pk	Prod Code
------	-----------------	----------------	----------------	---------------	--------	---------	-----------



True Union SR Threaded Ends - PVC Gray

1/2	YS2BP8-005SR	YS2BS8-005SR	YS3BP8-005SR	YS3BS8-005SR	1	12	102
3/4	YS2BP8-007SR	YS2BS8-007SR	YS3BP8-007SR	YS3BS8-007SR	1	8	102
1	YS2BP8-010SR	YS2BS8-010SR	YS3BP8-010SR	YS3BS8-010SR	1	8	102
1-1/4	YS2BP8-012SR	YS2BS8-012SR	YS3BP8-012SR	YS3BS8-012SR	1	4	102
1-1/2	YS2BP8-015SR	YS2BS8-015SR	YS3BP8-015SR	YS3BS8-015SR	1	0	102
2	YS2BP8-020SR	YS2BS8-020SR	YS3BP8-020SR	YS3BS8-020SR	1	0	102
3	YS2BP8-030SR	YS2BS8-030SR	YS3BP8-030SR	YS3BS8-030SR	1	0	102
4	YS2BP8-040SR	YS2BS8-040SR	YS3BP8-040SR	YS3BS8-040SR	1	0	102

Size	EPDM PVC Screen	EPDM SS Screen	FKM PVC Screen	FKM SS Screen	Std Pk	Mstr Pk	Prod Code
------	-----------------	----------------	----------------	---------------	--------	---------	-----------



True Union Socket Ends - PVC Clear

1/2	YS2AP8-005CL	YS2AS8-005CL	YS3AP8-005CL	YS3AS8-005CL	1	12	103
3/4	YS2AP8-007CL	YS2AS8-007CL	YS3AP8-007CL	YS3AS8-007CL	1	8	103
1	YS2AP8-010CL	YS2AS8-010CL	YS3AP8-010CL	YS3AS8-010CL	1	8	103
1-1/4	YS2AP8-012CL	YS2AS8-012CL	YS3AP8-012CL	YS3AS8-012CL	1	4	103
1-1/2	YS2AP8-015CL	YS2AS8-015CL	YS3AP8-015CL	YS3AS8-015CL	1	0	103
2	YS2AP8-020CL	YS2AS8-020CL	YS3AP8-020CL	YS3AS8-020CL	1	0	103
3	YS2AP8-030CL	YS2AS8-030CL	YS3AP8-030CL	YS3AS8-030CL	1	0	103
4	YS2AP8-040CL	YS2AS8-040CL	YS3AP8-040CL	YS3AS8-040CL	1	0	103

Suitable for Oil-Free air handling to 25 psi, not for distribution of compressed air or gas

JJD	member iapd <small>international association of plastics distribution</small>
JJ DOWNS INDUSTRIAL PLASTICS INC.	
416.236.1884	Toronto, ON
JJDOWNNS.COM	



Filters & Strainers Product
Strainers & Filters

Size	EPDM PVC Screen	EPDM SS Screen	FKM PVC Screen	FKM	Std Pk	Mstr Pk	Prod Code
------	-----------------	----------------	----------------	-----	--------	---------	-----------



True Union Threaded Ends - PVC Clear

1/2	YS2BP8-005CL	YS2BS8-005CL	YS3BP8-005CL	YS3BS8-005CL	1	12	103
3/4	YS2BP8-007CL	YS2BS8-007CL	YS3BP8-007CL	YS3BS8-007CL	1	8	103
1	YS2BP8-010CL	YS2BS8-010CL	YS3BP8-010CL	YS3BS8-010CL	1	8	103
1-1/4	YS2BP8-012CL	YS2BS8-012CL	YS3BP8-012CL	YS3BS8-012CL	1	4	103
1-1/2	YS2BP8-015CL	YS2BS8-015CL	YS3BP8-015CL	YS3BS8-015CL	1	0	103
2	YS2BP8-020CL	YS2BS8-020CL	YS3BP8-020CL	YS3BS8-020CL	1	0	103
3	YS2BP8-030CL	YS2BS8-030CL	YS3BP8-030CL	YS3BS8-030CL	1	0	103
4	YS2BP8-040CL	YS2BS8-040CL	YS3BP8-040CL	YS3BS8-040CL	1	0	103

Size	EPDM PVC Screen	EPDM SS Screen	FKM PVC Screen	FKM SS Screen	Std Pk	Mstr Pk	Prod Code
------	-----------------	----------------	----------------	---------------	--------	---------	-----------



True Union SR Threaded Ends - PVC Clear

1/2	YS2BP8-005CLSR	YS2BS8-005CLSR	YS3BP8-005CLSR	YS3BS8-005CLSR	1	12	103
3/4	YS2BP8-007CLSR	YS2BS8-007CLSR	YS3BP8-007CLSR	YS3BS8-007CLSR	1	8	103
1	YS2BP8-010CLSR	YS2BS8-010CLSR	YS3BP8-010CLSR	YS3BS8-010CLSR	1	8	103
1-1/4	YS2BP8-012CLSR	YS2BS8-012CLSR	YS3BP8-012CLSR	YS3BS8-012CLSR	1	4	103
1-1/2	YS2BP8-015CLSR	YS2BS8-015CLSR	YS3BP8-015CLSR	YS3BS8-015CLSR	1	0	103
2	YS2BP8-020CLSR	YS2BS8-020CLSR	YS3BP8-020CLSR	YS3BS8-020CLSR	1	0	103
3	YS2BP8-030CLSR	YS2BS8-030CLSR	YS3BP8-030CLSR	YS3BS8-030CLSR	1	0	103
4	YS2BP8-040CLSR	YS2BS8-040CLSR	YS3BP8-040CLSR	YS3BS8-040CLSR	1	0	103

Size	EPDM CPVC Screen	EPDM SS Screen	FKM CPVC Screen	FKM SS Screen	Std Pk	Mstr Pk	Prod Code
------	------------------	----------------	-----------------	---------------	--------	---------	-----------



True Union Socket Ends - CPVC

1/2	YS2AC8-005C	YS2AS8-005C	YS3AC8-005C	YS3AS8-005C	1	12	104
3/4	YS2AC8-007C	YS2AS8-007C	YS3AC8-007C	YS3AS8-007C	1	8	104
1	YS2AC8-010C	YS2AS8-010C	YS3AC8-010C	YS3AS8-010C	1	8	104
1-1/4	YS2AC8-012C	YS2AS8-012C	YS3AC8-012C	YS3AS8-012C	1	4	104
1-1/2	YS2AC8-015C	YS2AS8-015C	YS3AC8-015C	YS3AS8-015C	1	0	104
2	YS2AC8-020C	YS2AS8-020C	YS3AC8-020C	YS3AS8-020C	1	0	104
3	YS2AC8-030C	YS2AS8-030C	YS3AC8-030C	YS3AS8-030C	1	0	104
4	YS2AC8-040C	YS2AS8-040C	YS3AC8-040C	YS3AS8-040C	1	0	104

Size	EPDM CPVC Screen	EPDM SS Screen	FKM CPVC Screen	FKM SS Screen	Std Pk	Mstr Pk	Prod Code
------	------------------	----------------	-----------------	---------------	--------	---------	-----------



True Union Threaded Ends - CPVC

1/2	YS2BC8-005C	YS2BS8-005C	YS3BC8-005C	YS3BS8-005C	1	12	104
3/4	YS2BC8-007C	YS2BS8-007C	YS3BC8-007C	YS3BS8-007C	1	8	104

Suitable for Oil-Free air handling to 25 psi, not for distribution of compressed air or gas

JJ DOWNS INDUSTRIAL PLASTICS INC.

416.236.1884
Toronto, ON
JJDOWNS.COM



Filters & Strainers Product
Strainers & Filters

Size	EPDM CPVC Screen	EPDM SS Screen	FKM CPVC Screen	FKM SS Screen	Std Pk	Mstr Pk	Prod Code
True Union Threaded Ends - CPVC (continued)							
1	YS2BC8-010C	YS2BS8-010C	YS3BC8-010C	YS3BS8-010C	1	8	104
1-1/4	YS2BC8-012C	YS2BS8-012C	YS3BC8-012C	YS3BS8-012C	1	4	104
1-1/2	YS2BC8-015C	YS2BS8-015C	YS3BC8-015C	YS3BS8-015C	1	0	104
2	YS2BC8-020C	YS2BS8-020C	YS3BC8-020C	YS3BS8-020C	1	0	104
3	YS2BC8-030C	YS2BS8-030C	YS3BC8-030C	YS3BS8-030C	1	0	104
4	YS2BC8-040C	YS2BS8-040C	YS3BC8-040C	YS3BS8-040C	1	0	104

Size	EPDM CPVC Screen	EPDM SS Screen	FKM CPVC Screen	FKM SS Screen	Std Pk	Mstr Pk	Prod Code
------	------------------	----------------	-----------------	---------------	--------	---------	-----------



True Union SR Threaded Ends - CPVC

1/2	YS2BC8-005CSR	YS2BS8-005CSR	YS3BC8-005CSR	YS3BS8-005CSR	1	12	104
3/4	YS2BC8-007CSR	YS2BS8-007CSR	YS3BC8-007CSR	YS3BS8-007CSR	1	12	104
1	YS2BC8-010CSR	YS2BS8-010CSR	YS3BC8-010CSR	YS3BS8-010CSR	1	8	104
1-1/4	YS2BC8-012CSR	YS2BS8-012CSR	YS3BC8-012CSR	YS3BS8-012CSR	1	4	104
1-1/2	YS2BC8-015CSR	YS2BS8-015CSR	YS3BC8-015CSR	YS3BS8-015CSR	1	0	104
2	YS2BC8-020CSR	YS2BS8-020CSR	YS3BC8-020CSR	YS3BS8-020CSR	1	0	104
3	YS2BC8-030CSR	YS2BS8-030CSR	YS3BC8-030CSR	YS3BS8-030CSR	1	0	104
4	YS2BC8-040CSR	YS2BS8-040CSR	YS3BC8-040CSR	YS3BS8-040CSR	1	0	104

Size	EPDM Seals PVC Screen	EPDM Seals SS Screen	FKM Seals PVC Screen	FKM Seals SS Screen	Std Pk	Mstr Pk	Prod Code
------	-----------------------	----------------------	----------------------	---------------------	--------	---------	-----------

Y-Strainer PVC Repair Kits

Kit Includes Elastomer Seals, Bonnet Nut, Screen Support Housing, Support Ring, Designated Screen, Retainer Clip, and Drain Plug



1/2	YS-EP8-005	YS-ES8-005	YS-VP8-005	YS-VS8-005	1	18	299
3/4	YS-EP8-007	YS-ES8-007	YS-VP8-007	YS-VS8-007	1	18	299
1	YS-EP8-010	YS-ES8-010	YS-VP8-010	YS-VS8-010	1	12	299
1-1/4	YS-EP8-012	YS-ES8-012	YS-VP8-012	YS-VS8-012	1	12	299
1-1/2	YS-EP8-015	YS-ES8-015	YS-VP8-015	YS-VS8-015	1	12	299
2	YS-EP8-020	YS-ES8-020	YS-VP8-020	YS-VS8-020	1	0	299
3	YS-EP8-030	YS-ES8-030	YS-VP8-030	YS-VS8-030	1	0	299
4	YS-EP8-040	YS-ES8-040	YS-VP8-040	YS-VS8-040	1	0	299

Part numbers shown reflect a mesh size of 8. For different mesh sizes, substitute Mesh Code in part number as specified in chart at beginning of Y-Strainer listings

Suitable for Oil-Free air handling to 25 psi, not for distribution of compressed air or gas

JJ DOWNS INDUSTRIAL PLASTICS INC.

416.236.1884
Toronto, ON
JJDOWNS.COM



Filters & Strainers Product
Strainers & Filters

Size	EPDM Seals CPVC Screen	EPDM Seals SS Screen	FKM Seals CPVC Screen	FKM Seals SS Screen	Std Pk	Mstr Pk	Prod Code
------	------------------------	----------------------	-----------------------	---------------------	--------	---------	-----------

Y-Strainer CPVC Repair Kits

Kit Includes Elastomer Seals, Bonnet Nut, Screen Support Housing, Support Ring, Designated Screen, Retainer Clip, and Drain Plug



1/2	YS-EC8-005	YS-ES8-005C	YS-VC8-005	YS-VS8-005C	1	18	299
3/4	YS-EC8-007	YS-ES8-007C	YS-VC8-007	YS-VS8-007C	1	18	299
1	YS-EC8-010	YS-ES8-010C	YS-VC8-010	YS-VS8-010C	1	18	299
1-1/4	YS-EC8-012	YS-ES8-012C	YS-VC8-012	YS-VS8-012C	1	12	299
1-1/2	YS-EC8-015	YS-ES8-015C	YS-VC8-015	YS-VS8-015C	1	12	299
2	YS-EC8-020	YS-ES8-020C	YS-VC8-020	YS-VS8-020C	1	12	299
3	YS-EC8-030	YS-ES8-030C	YS-VC8-030	YS-VS8-030C	1	0	299
4	YS-EC8-040	YS-ES8-040C	YS-VC8-040	YS-VS8-040C	1	0	299

Part numbers shown reflect a mesh size of 8. For different mesh sizes, substitute Mesh Code in part number as specified in chart at beginning of Y-Strainer listings

Suitable for Oil-Free air handling to 25 psi, not for distribution of compressed air or gas

	 <small>member international association of plastics distribution</small>
<p>JJ DOWNS INDUSTRIAL PLASTICS INC.</p>	
<p>416.236.1884</p>	<p>Toronto, ON</p>
<p>JJDOWNS.COM</p>	



Filters & Strainers Product
Strainers & Filters

Y-Strainer O-ring Repair Kits

Size	EPDM O-ring Kits	FKM O-ring Kits	Std Pk	Mstr Pk	Prod Code
Kit Includes Housing O-ring, Plug O-ring and True Union End connector O-rings in Designated Elastomer					
1/2	YS-ERKU-005	YS-VRKU-005	1	10	299
3/4	YS-ERKU-007	YS-VRKU-007	1	10	299
1	YS-ERKU-010	YS-VRKU-010	1	10	299
1-1/4	YS-ERKU-012	YS-VRKU-012	1	10	299
1-1/2	YS-ERKU-015	YS-VRKU-015	1	10	299
2	YS-ERKU-020	YS-VRKU-020	1	10	299
3	YS-ERKU-030	YS-VRKU-030	1	10	299
4	YS-ERKU-040	YS-VRKU-040	1	10	299
For use in all Spears® PVC & CPVC Y-Strainers					
Part Number	Size		Std Pk	Mstr Ctn	Prod Code



Magnetic Drain Plugs - PVC

Optional Drain Plug Replacement

MDP-007	1/2 & 3/4	1	25	299
MDP-010	1	1	25	299
MDP-012	1-1/4	1	25	299
MDP-015	1-1/2 to 4	1	25	299



Magnetic Drain Plug - CPVC

Optional Drain Plug Replacement

MDP-007C	1/2 & 3/4	1	10	299
MDP-010C	1	1	25	299
MDP-012C	1-1/4	1	25	299
MDP-015C	1-1/2 to 4	1	10	299

Suitable for Oil-Free air handling to 25 psi, not for distribution of compressed air or gas

JJ DOWNS INDUSTRIAL PLASTICS INC.

416.236.1884
Toronto, ON
JJDOWNS.COM



Filters & Strainers Product
Strainers & Filters

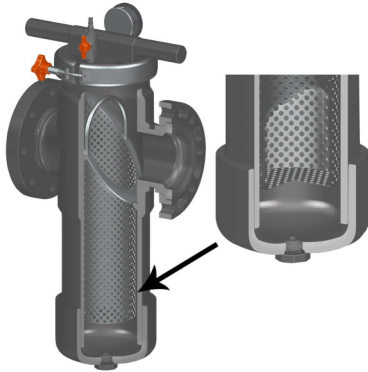

Important Ordering Information - Column headings indicate Elastomer seal type and Strainer Basket screen material. All Part Numbers shown designate 1/8" perforated (#6 Mesh Code) Strainer Basket Screens. To order other screen perforation sizing, replace the number "6" preceding the dash-separator with the corresponding Mesh Code from chart. MSRP is the same for all listed Mesh Codes.

Perforation Size	Mesh Code
1/16"	12
3/32"	8
1/8"	6
3/16"	4
1/4"	3
3/8"	2

Pressure Rating
@ 73°F (23°C), Water

1/2"-8" 150 psi
10"-12" 50 psi

Maximum Service Temperature

PVC = 140°F (60°C)
CPVC = 200°F (93°C)

Temperature/Pressure De-ratings Apply

Example: To order a 1/16" screen perforation in listed part number BS22P6-020, change the part number to BS22P12 -020

Contact Spears® for additional perforations & wire mesh sizes

Size	EPDM Seals PVC Screen	EPDM Seals SS Screen	FKM Seals PVC Screen	FKM Seals SS Screen	Std Pk	Mstr Pk	Prod Code
------	-----------------------	----------------------	----------------------	---------------------	--------	---------	-----------



Basket Strainer PVC - Socket Ends

Size	EPDM Seals PVC Screen	EPDM Seals SS Screen	FKM Seals PVC Screen	FKM Seals SS Screen	Std Pk	Mstr Pk	Prod Code
1/2	BS22P6-005	BS22S6-005	BS32P6-005	BS32S6-005	1	2	295
3/4	BS22P6-007	BS22S6-007	BS32P6-007	BS32S6-007	1	2	295
1	BS22P6-010	BS22S6-010	BS32P6-010	BS32S6-010	1	2	295
1-1/4	BS22P6-012	BS22S6-012	BS32P6-012	BS32S6-012	1	0	295
1-1/2	BS22P6-015	BS22S6-015	BS32P6-015	BS32S6-015	1	0	295
2	BS22P6-020	BS22S6-020	BS32P6-020	BS32S6-020	1	0	295
2-1/2	BS22P6-025	BS22S6-025	BS32P6-025	BS32S6-025	1	0	295
3	BS22P6-030	BS22S6-030	BS32P6-030	BS32S6-030	1	0	295
4	BS22P6-040	BS22S6-040	BS32P6-040	BS32S6-040	1	0	295
6	BS22P6-060	BS22S6-060	BS32P6-060	BS32S6-060	1	0	295
8	BS22P6-080	BS22S6-080	BS32P6-080	BS32S6-080	1	0	295
10	BS22P6-100	BS22S6-100	BS32P6-100	BS32S6-100	1	0	295
12	BS22P6-120	BS22S6-120	BS32P6-120	BS32S6-120	1	0	295

Basket Strainer PVC - Flanged Ends

Size	EPDM Seals PVC Screen	EPDM Seals SS Screen	FKM Seals PVC Screen	FKM Seals SS Screen	Std Pk	Mstr Pk	Prod Code
1/2	BS23P6-005	BS23S6-005	BS33P6-005	BS33S6-005	1	0	295
3/4	BS23P6-007	BS23S6-007	BS33P6-007	BS33S6-007	1	0	295
1	BS23P6-010	BS23S6-010	BS33P6-010	BS33S6-010	1	0	295
1-1/4	BS23P6-012	BS23S6-012	BS33P6-012	BS33S6-012	1	0	295
1-1/2	BS23P6-015	BS23S6-015	BS33P6-015	BS33S6-015	1	0	295
2	BS23P6-020	BS23S6-020	BS33P6-020	BS33S6-020	1	0	295
2-1/2	BS23P6-025	BS23S6-025	BS33P6-025	BS33S6-025	1	0	295
3	BS23P6-030	BS23S6-030	BS33P6-030	BS33S6-030	1	0	295

Suitable for Oil-Free air handling to 25 psi, not for distribution of compressed air or gas

JJ DOWNS INDUSTRIAL PLASTICS INC.

416.236.1884
Toronto, ON
JJDOWNS.COM



Filters & Strainers Product
Strainers & Filters

Basket Strainer PVC - Flanged Ends (continued)

Size	EPDM Seals PVC Screen	EPDM Seals SS Screen	FKM Seals PVC Screen	FKM Seals SS Screen	Std Pk	Mstr Pk	Prod Code
4	BS23P6-040	BS23S6-040	BS33P6-040	BS33S6-040	1	0	295
6	BS23P6-060	BS23S6-060	BS33P6-060	BS33S6-060	1	0	295
8	BS23P6-080	BS23S6-080	BS33P6-080	BS33S6-080	1	0	295
10	BS23P6-100	BS23S6-100	BS33P6-100	BS33S6-100	1	0	295
12	BS23P6-120	BS23S6-120	BS33P6-120	BS33S6-120	1	0	295

Size	EPDM Seals PVC Screen	EPDM Seals SS Screen	FKM Seals PVC Screen	FKM Seals SS Screen	Std Pk	Mstr Pk	Prod Code
------	-----------------------	----------------------	----------------------	---------------------	--------	---------	-----------

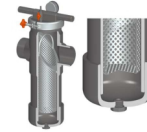

Basket Strainer PVC - Spigot Ends

1/2	BS27P6-005	BS27S6-005	BS37P6-005	BS37S6-005	1	0	295
3/4	BS27P6-007	BS27S6-007	BS37P6-007	BS37S6-007	1	0	295
1	BS27P6-010	BS27S6-010	BS37P6-010	BS37S6-010	1	0	295
1-1/4	BS27P6-012	BS27S6-012	BS37P6-012	BS37S6-012	1	0	295
1-1/2	BS27P6-015	BS27S6-015	BS37P6-015	BS37S6-015	1	0	295
2	BS27P6-020	BS27S6-020	BS37P6-020	BS37S6-020	1	0	295
2-1/2	BS27P6-025	BS27S6-025	BS37P6-025	BS37S6-025	1	0	295
3	BS27P6-030	BS27S6-030	BS37P6-030	BS37S6-030	1	0	295
4	BS27P6-040	BS27S6-040	BS37P6-040	BS37S6-040	1	0	295
6	BS27P6-060	BS27S6-060	BS37P6-060	BS37S6-060	1	0	295
8	BS27P6-080	BS27S6-080	BS37P6-080	BS37S6-080	1	0	295
10	BS27P6-100	BS27S6-100	BS37P6-100	BS37S6-100	1	0	295
12	BS27P6-120	BS27S6-120	BS37P6-120	BS37S6-120	1	0	295

Size	EPDM Seals CPVC Screen	EPDM Seals SS Screen	FKM Seals CPVC Screen	FKM Seals SS Screen	Std Pk	Mstr Pk	Prod Code
------	------------------------	----------------------	-----------------------	---------------------	--------	---------	-----------

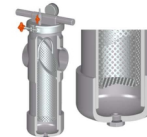

Basket Strainer CPVC - Socket Ends

1/2	BS22C6-005C	BS22S6-005C	BS32C6-005C	BS32S6-005C	1	2	297
3/4	BS22C6-007C	BS22S6-007C	BS32C6-007C	BS32S6-007C	1	2	297
1	BS22C6-010C	BS22S6-010C	BS32C6-010C	BS32S6-010C	1	2	297
1-1/4	BS22C6-012C	BS22S6-012C	BS32C6-012C	BS32S6-012C	1	0	297
1-1/2	BS22C6-015C	BS22S6-015C	BS32C6-015C	BS32S6-015C	1	0	297
2	BS22C6-020C	BS22S6-020C	BS32C6-020C	BS32S6-020C	1	0	297
2-1/2	BS22C6-025C	BS22S6-025C	BS32C6-025C	BS32S6-025C	1	0	297
3	BS22C6-030C	BS22S6-030C	BS32C6-030C	BS32S6-030C	1	0	297
4	BS22C6-040C	BS22S6-040C	BS32C6-040C	BS32S6-040C	1	0	297
6	BS22C6-060C	BS22S6-060C	BS32C6-060C	BS32S6-060C	1	0	297
8	BS22C6-080C	BS22S6-080C	BS32C6-080C	BS32S6-080C	1	0	297
10	BS22C6-100C	BS22S6-100C	BS32C6-100C	BS32S6-100C	1	0	297
12	BS22C6-120C	BS22S6-120C	BS32C6-120C	BS32S6-120C	1	0	297

Suitable for Oil-Free air handling to 25 psi, not for distribution of compressed air or gas

JJ DOWNS INDUSTRIAL PLASTICS INC.

416.236.1884
Toronto, ON
JJDOWNS.COM



Filters & Strainers Product
Strainers & Filters

Size	EPDM Seals CPVC Screen	EPDM Seals SS Screen	FKM Seals CPVC Screen	FKM Seals SS Screen	Std Pk	Mstr Pk	Prod Code
------	------------------------	----------------------	-----------------------	---------------------	--------	---------	-----------



Basket Strainer CPVC - Flanged Ends

1/2	BS23C6-005C	BS23S6-005C	BS33C6-005C	BS33S6-005C	1	0	297
3/4	BS23C6-007C	BS23S6-007C	BS33C6-007C	BS33S6-007C	1	0	297
1	BS23C6-010C	BS23S6-010C	BS33C6-010C	BS33S6-010C	1	0	297
1-1/4	BS23C6-012C	BS23S6-012C	BS33C6-012C	BS33S6-012C	1	0	297
1-1/2	BS23C6-015C	BS23S6-015C	BS33C6-015C	BS33S6-015C	1	0	297
2	BS23C6-020C	BS23S6-020C	BS33C6-020C	BS33S6-020C	1	0	297
2-1/2	BS23C6-025C	BS23S6-025C	BS33C6-025C	BS33S6-025C	1	4	297
3	BS23C6-030C	BS23S6-030C	BS33C6-030C	BS33S6-030C	1	0	297
4	BS23C6-040C	BS23S6-040C	BS33C6-040C	BS33S6-040C	1	0	297
6	BS23C6-060C	BS23S6-060C	BS33C6-060C	BS33S6-060C	1	0	297
8	BS23C6-080C	BS23S6-080C	BS33C6-080C	BS33S6-080C	1	0	297
10	BS23C6-100C	BS23S6-100C	BS33C6-100C	BS33S6-100C	1	0	297
12	BS23C6-120C	BS23S6-120C	BS33C6-120C	BS33S6-120C	1	0	297

Size	EPDM Seals CPVC Screen	EPDM Seals SS Screen	FKM Seals CPVC Screen	FKM Seals SS Screen	Std Pk	Mstr Pk	Prod Code
------	------------------------	----------------------	-----------------------	---------------------	--------	---------	-----------

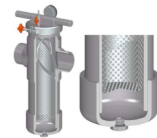

Basket Strainer CPVC - Spigot Ends

Spigot Ends

1/2	BS27C6-005C	BS27S6-005C	BS37C6-005C	BS37S6-005C	1	0	297
3/4	BS27C6-007C	BS27S6-007C	BS37C6-007C	BS37S6-007C	1	0	297
1	BS27C6-010C	BS27S6-010C	BS37C6-010C	BS37S6-010C	1	0	297
1-1/4	BS27C6-012C	BS27S6-012C	BS37C6-012C	BS37S6-012C	1	0	297
1-1/2	BS27C6-015C	BS27S6-015C	BS37C6-015C	BS37S6-015C	1	0	297
2	BS27C6-020C	BS27S6-020C	BS37C6-020C	BS37S6-020C	1	0	297
2-1/2	BS27C6-025C	BS27S6-025C	BS37C6-025C	BS37S6-025C	1	0	297
3	BS27C6-030C	BS27S6-030C	BS37C6-030C	BS37S6-030C	1	0	297
4	BS27C6-040C	BS27S6-040C	BS37C6-040C	BS37S6-040C	1	0	297
6	BS27C6-060C	BS27S6-060C	BS37C6-060C	BS37S6-060C	1	0	297
8	BS27C6-080C	BS27S6-080C	BS37C6-080C	BS37S6-080C	1	0	297
10	BS27C6-100C	BS27S6-100C	BS37C6-100C	BS37S6-100C	1	0	297
12	BS27C6-120C	BS27S6-120C	BS37C6-120C	BS37S6-120C	1	0	297

Suitable for Oil-Free air handling to 25 psi, not for distribution of compressed air or gas

JJ DOWNS INDUSTRIAL PLASTICS INC.

416.236.1884
Toronto, ON
JJDOWNS.COM

Size	EPDM Seals CPVC Screen	EPDM Seals SS Screen	FKM Seals CPVC Screen	FKM Seals SS Screen	Std Pk	Mstr Pk	Prod Code
------	------------------------	----------------------	-----------------------	---------------------	--------	---------	-----------

Basket Strainer CPVC - Spigot Ends (continued)
Spigot Ends

Custom configured and produced to order, Spears® Duplex Basket Strainer provides individual isolation of strainers for servicing and cleaning without shutting down the line. A center handle on the Duplex unit control valves allows selection of either strainer unit for isolation. Each Basket Strainer features a convenient quick release clamp cap equipped with safety pressure gauge and pressure release ball valve for safer system operation and strainer cleaning. Additional drain plug allows complete drain and flush of unit.

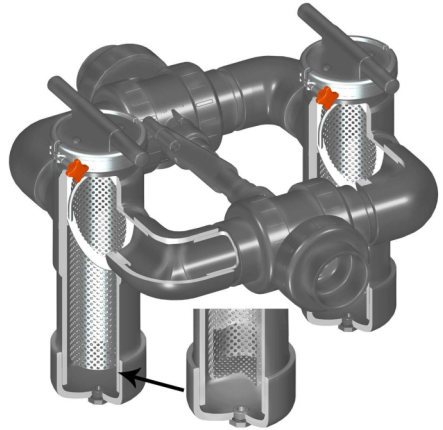

Multi-Featured Options:

- No Flow Shutdown Required
- Sizes 1/2 - 4" Constructed from Corrosion Resistant PVC or CPVC
- True Union Socket, Thread, or Flanged Connections
- Uses Spears® Standard Basket Strainers Configurations
- Simple Single-Throw Lever Operation
- Select EPDM or FKM Seal Options
- Multiple Strainer Mesh Options in Plastic or Stainless Steel (see Industrial Basket Strainer options in this catalog)

Pressure Rating @ 73°F (23°C), Water
 1/2" - 4" 150 psi
Maximum Service Temperature
 PVC = 140°F (60°C)
 CPVC = 200°F (93°C)
 Temperature/Pressure De-ratings Apply

CONTACT SPEARS® FOR ADDITIONAL CUSTOM OPTIONS, SELECTION ASSISTANCE & MSRP

Suitable for Oil-Free air handling to 25 psi, not for distribution of compressed air or gas



JJ DOWNS INDUSTRIAL PLASTICS INC.



member
iapd
international association
of plastics distribution

416.236.1884
Toronto, ON
JJDOWNS.COM



Filters & Strainers Product
Strainers & Filters

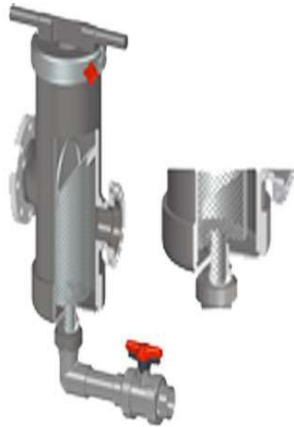

Pressure Rating @ 73°F (23°C),
Water 50 psi

Maximum Service Temperature
PVC = 140°F (60°C)

Temperature/Pressure De-ratings Apply

Suction Strainer is a special Basket Strainer design that reduces pressure drop, a critical element in suction line applications. While same-size (inlet/outlet) units are available, enlarged inlet on reducing sizes performs best in suction line applications. The internal Strainer Basket is bottom-drained for direct flushing through a 360° adjustable side mounted Discharge Valve Assembly (included). Quick release clamp retains Bonnet with Top Sight-Glass.

Standard units listed have EPDM Seals and Stainless Steel 3/16" Perforated Screen (4-mesh). Contact Spears® for other Mesh Code or Elastomer seal options required.

Part Number	Size	Std Pk	Mstr Ctn	Prod Code
Suction Strainer PVC (continued)				
Flanged End				
SS23BS4SG-582	8X4	1	0	295
SS23BS4SG-585	8X6	1	0	295
SS23BS4SG-100	10	1	0	295
SS23BS4SG-626	10X6	1	0	295
SS23BS4SG-628	10X8	1	0	295
SS23BS4SG-120	12	1	0	295
SS23BS4SG-668	12X8	1	0	295
SS23BS4SG-670	12X10	1	0	295

Part Number	Size	Std Pk	Mstr Ctn	Prod Code
Suction Strainer Baskets				
Stainless Steel				
SSS4-040	4	1	4	299
SSS4-060	6	1	2	299
SSS4-080	8	1	2	299
SSS4-100	10	1	0	299
SSS4-120	12	1	2	299

Part Number	Size	Std Pk	Mstr Ctn	Prod Code
-------------	------	--------	----------	-----------

Suction Strainer PVC

Flanged End



SS23BS4SG-040	4	1	0	295
SS23BS4SG-420	4X2	1	0	295
SS23BS4SG-421	4X2-1/2	1	0	295
SS23BS4SG-422	4X3	1	0	295
SS23BS4SG-060	6	1	0	295
SS23BS4SG-532	6X4	1	0	295
SS23BS4SG-080	8	1	0	295

Suitable for Oil-Free air handling to 25 psi, not for distribution of compressed air or gas

JJ DOWNS INDUSTRIAL PLASTICS INC.

416.236.1884
Toronto, ON
JJDOWNS.COM