

veradek — outdoor

hanging geo instructions

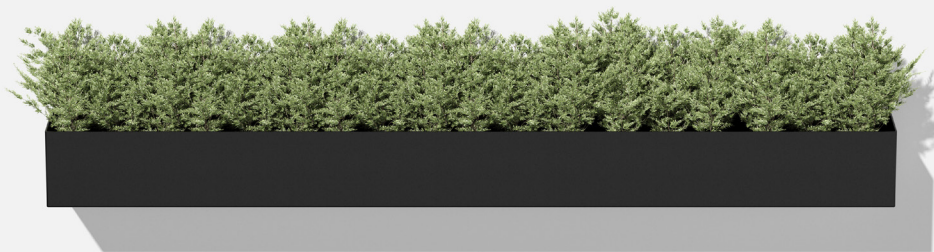

V
|
O

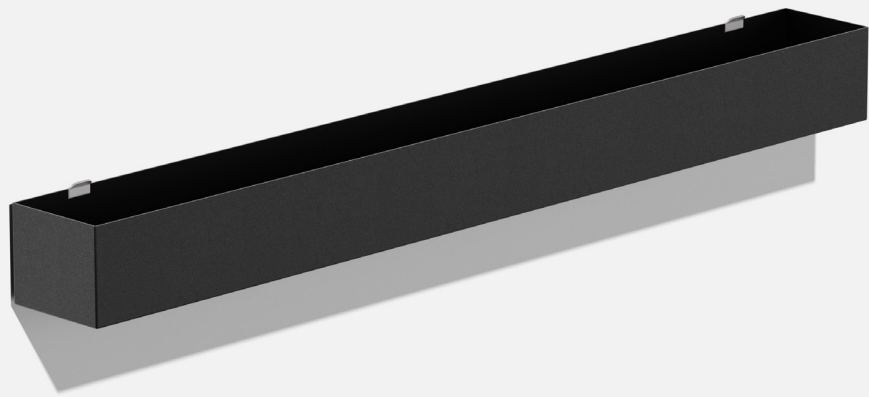

parts and components



2x
Hanging
Bracket



2x
Drywall
Anchor



2x
Anchor
Screw

Not Included



3/16"
Drill Bit



Pencil



Tape
Measure

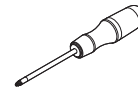

Phillips
Screwdriver

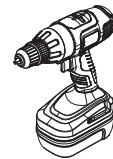

Cordless
Drill

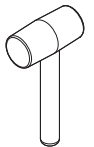

Rubber
Mallet



Level

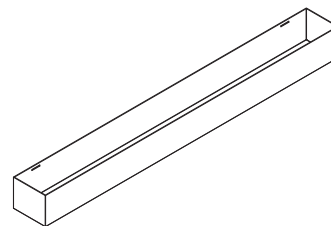

1x
Hanging Geo
Planter

part a



Pencil



Tape Measure



Level

Mark two points
27.25" apart

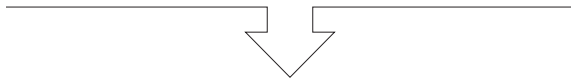
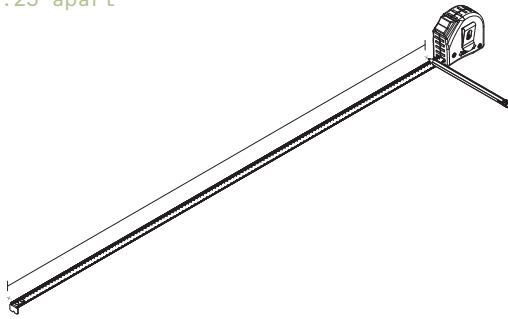

Ensure marks are level

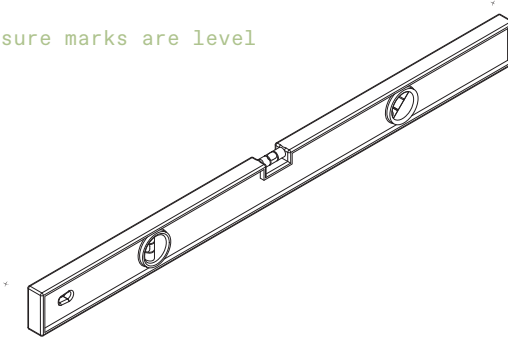

part b



3/16"
Drill Bit



2x
Drywall
Anchor



Cordless
Drill



Rubber
Mallet

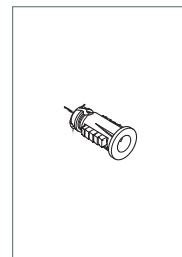
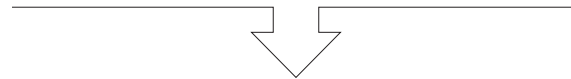
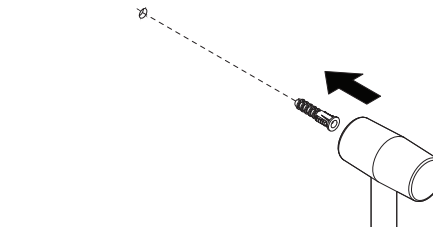
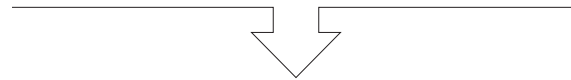
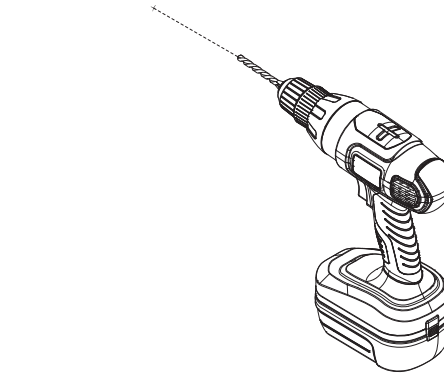

x2

part c

2x
Anchor
Screw



2x
Hanging
Bracket



Phillips
Screwdriver

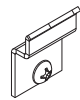
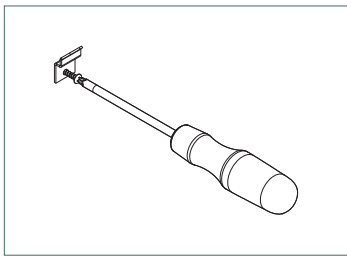
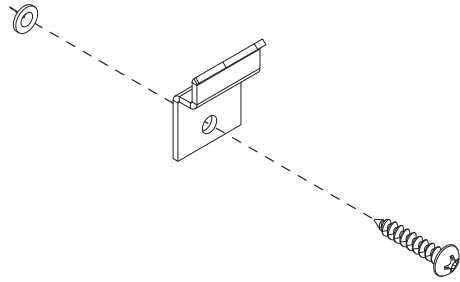

x2

part d

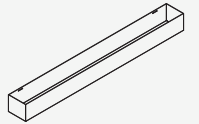

1x
Hanging Geo
Planter

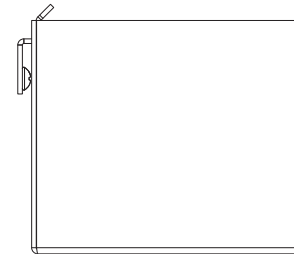
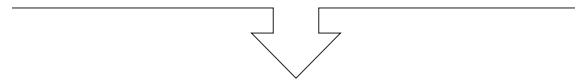
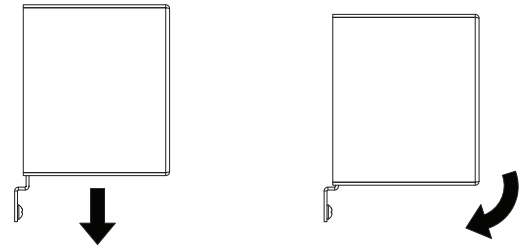
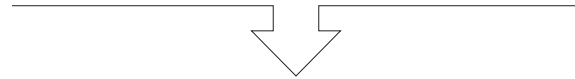
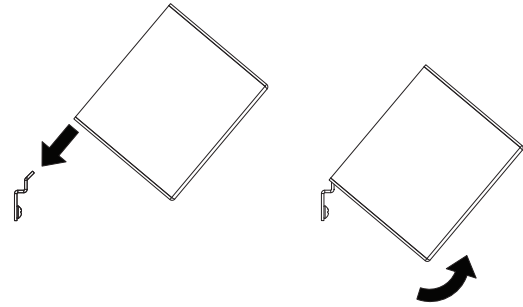

complete

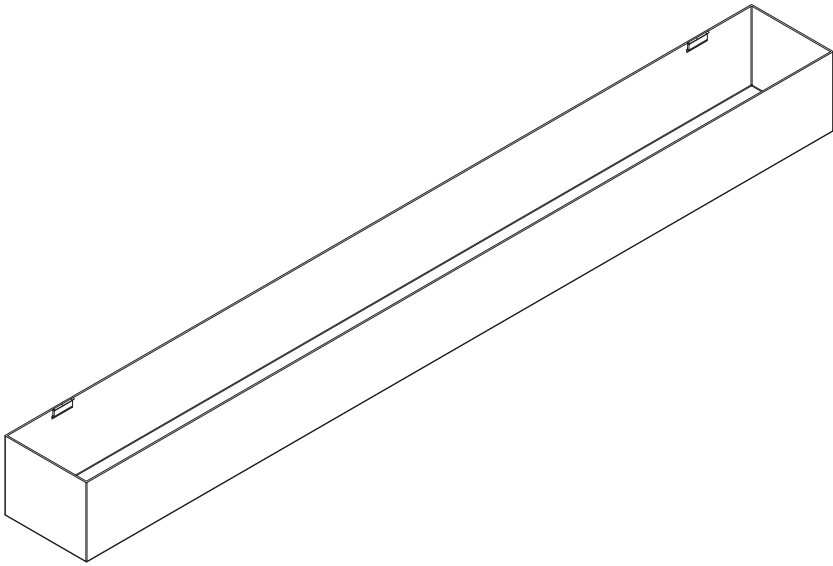

assemble.
arrange.
transform.

your living
space
extended.

V
|
O

01 hanging geo - 02 geo tall - 03 geo short - 04 geo wide -
05 geo trough

about the geo series

Bring your tabletop to life with the Geo Series! Whether indoors or out, Geo Series planters are the perfect frame for your smaller, more delicate plants. Made from the same high-grade steel used in our Metallic Series, your arrangements will be so beautiful that you might not even want to remove them to make space for the food!

Check out more Geo Series products at veradek.com
Questions? Email info@veradek.com

meet you
outside.